

Simscape™ Fluids™

Reference



MATLAB® & SIMULINK®

R2021b



How to Contact MathWorks



Latest news: www.mathworks.com
Sales and services: www.mathworks.com/sales_and_services
User community: www.mathworks.com/matlabcentral
Technical support: www.mathworks.com/support/contact_us



Phone: 508-647-7000



The MathWorks, Inc.
1 Apple Hill Drive
Natick, MA 01760-2098

Simscape™ Fluids™ Reference

© COPYRIGHT 2006–2021 by The MathWorks, Inc.

The software described in this document is furnished under a license agreement. The software may be used or copied only under the terms of the license agreement. No part of this manual may be photocopied or reproduced in any form without prior written consent from The MathWorks, Inc.

FEDERAL ACQUISITION: This provision applies to all acquisitions of the Program and Documentation by, for, or through the federal government of the United States. By accepting delivery of the Program or Documentation, the government hereby agrees that this software or documentation qualifies as commercial computer software or commercial computer software documentation as such terms are used or defined in FAR 12.212, DFARS Part 227.72, and DFARS 252.227-7014. Accordingly, the terms and conditions of this Agreement and only those rights specified in this Agreement, shall pertain to and govern the use, modification, reproduction, release, performance, display, and disclosure of the Program and Documentation by the federal government (or other entity acquiring for or through the federal government) and shall supersede any conflicting contractual terms or conditions. If this License fails to meet the government's needs or is inconsistent in any respect with federal procurement law, the government agrees to return the Program and Documentation, unused, to The MathWorks, Inc.

Trademarks

MATLAB and Simulink are registered trademarks of The MathWorks, Inc. See www.mathworks.com/trademarks for a list of additional trademarks. Other product or brand names may be trademarks or registered trademarks of their respective holders.

Patents

MathWorks products are protected by one or more U.S. patents. Please see www.mathworks.com/patents for more information.

Revision History

March 2006	Online only	New for Version 1.0 (Release 2006a+)
September 2006	Online only	Revised for Version 1.1 (Release 2006b)
March 2007	Online only	Revised for Version 1.2 (Release 2007a)
September 2007	Online only	Revised for Version 1.2.1 (Release 2007b)
March 2008	Online only	Revised for Version 1.3 (Release 2008a)
October 2008	Online only	Revised for Version 1.4 (Release 2008b)
March 2009	Online only	Revised for Version 1.5 (Release 2009a)
September 2009	Online only	Revised for Version 1.6 (Release 2009b)
March 2010	Online only	Revised for Version 1.7 (Release 2010a)
September 2010	Online only	Revised for Version 1.8 (Release 2010b)
April 2011	Online only	Revised for Version 1.9 (Release 2011a)
September 2011	Online only	Revised for Version 1.10 (Release 2011b)
March 2012	Online only	Revised for Version 1.10.1 (Release 2012a)
September 2012	Online only	Revised for Version 1.11 (Release 2012b)
March 2013	Online only	Revised for Version 1.12 (Release 2013a)
September 2013	Online only	Revised for Version 1.13 (Release 2013b)
March 2014	Online only	Revised for Version 1.14 (Release 2014a)
October 2014	Online only	Revised for Version 1.15 (Release 2014b)
March 2015	Online only	Revised for Version 1.16 (Release 2015a)
September 2015	Online only	Revised for Version 1.17 (Release 2015b)
March 2016	Online only	Revised for Version 2.0 (Release 2016a) (Renamed from <i>SimHydraulics</i> [®] <i>Reference</i>)
September 2016	Online only	Revised for Version 2.1 (Release R2016b)
March 2017	Online only	Revised for Version 2.2 (Release R2017a)
September 2017	Online only	Revised for Version 2.3 (Release R2017b)
March 2018	Online only	Revised for Version 2.4 (Release R2018a)
September 2018	Online only	Revised for Version 2.5 (Release R2018b)
March 2019	Online only	Revised for Version 2.6 (Release R2019a)
September 2019	Online only	Revised for Version 2.7 (Release R2019b)
March 2020	Online only	Revised for Version 3.0 (Release R2020a)
September 2020	Online only	Revised for Version 3.1 (Release R2020b)
March 2021	Online only	Revised for Version 3.2 (Release R2021a)
September 2021	Online only	Revised for Version 3.3 (Release R2021b)

1 | Blocks

A | Bibliography

Blocks

2-Position Valve Actuator

Actuator for two-position valves



Library

Valve Actuators

Description

The 2-Position Valve Actuator block represents an actuator that you can use with directional valves to control their position. This actuator can drive a two-position valve. The block is developed as a data-sheet-based model and all its parameters are generally provided in catalogs or data sheets. The key parameters are the stroke, switch-on, and switch-off times.

The block accepts a physical input signal and produces a physical output signal that can be associated with a mechanical translational or rotational push-pin motion. Connect the block output to the directional valve control port.

The actuator is represented as an ideal transducer, where output does not depend on the load exerted on the push-pin and the push-pin motion profile remains the same under any loading conditions. The motion profile represents a typical transition curve for electromagnetic actuators and is shown in the following figure:

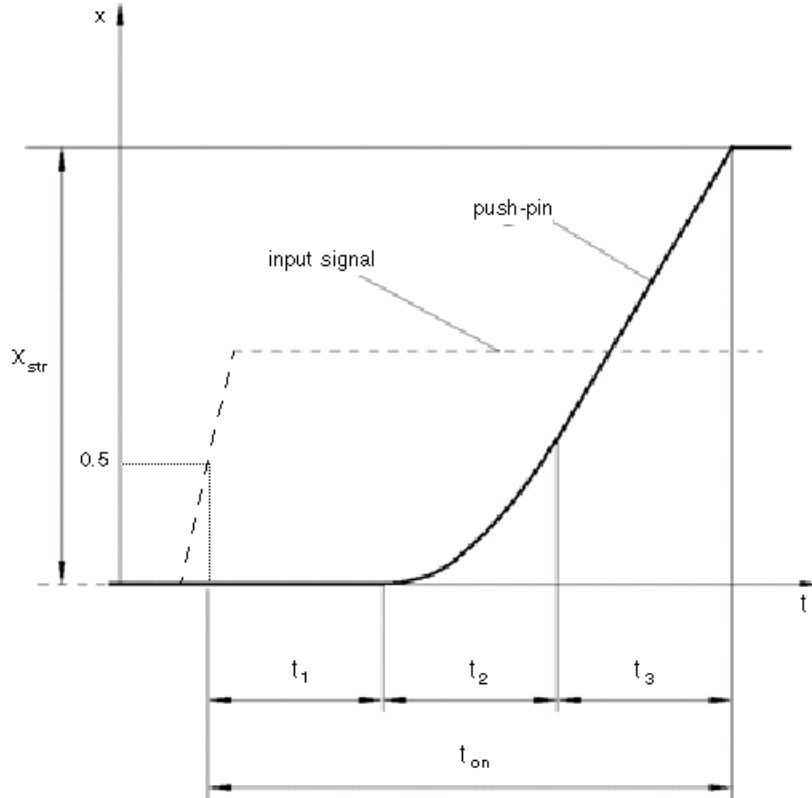

The push-pin is actuated when the input signal value crosses the threshold of 50% of the nominal input signal, where **Nominal signal value** is a block parameter. The motion is divided into three phases, equal in time: delay (t_1), motion at constant acceleration (t_2), and motion at constant velocity (t_3). The motion stops when the switch-on time (t_{on}) elapses. At this moment, the push-pin reaches the specified stroke value (x_{str}). To return the push-pin into initial position, the control signal must cross back through the threshold of 50% of the nominal input signal, which causes the push-pin to retract. The retract motion follows exactly the same profile but “stretches” over the switch-off time. **Switching-on time** and **Switching-off time** are the block parameters.

The transition in any direction can be interrupted at any time by changing the input signal. If motion is interrupted, the switch-on or switch-off times are proportionally decreased depending on the instantaneous push-pin position.

The push-pin is actuated only by positive signal, similar to the AC or DC electromagnets. The direction of push-pin motion is controlled by the **Actuator orientation** parameter, which can have one of two values: **Acts in positive direction** or **Acts in negative direction**.

Basic Assumptions and Limitations

Push-pin loading, such as inertia, spring, hydraulic forces, and so on, is not taken into account.

Parameters

Push-pin stroke

The push-pin stroke. The default value is 0.01 m.

Switching-on time

Time necessary to fully extend the push-pin after the control signal is applied. The default value is 0.1 s.

Switching-off time

Time necessary to retract push-pin from fully extended position after the input signal is removed. The default value is 0.1 s.

Nominal signal value

Sets the value of the nominal input signal. The output motion is initiated as the input signal crosses 50% value of the nominal signal. Other than that, the input signal has no effect on the motion profile. This parameter is meant to reproduce the rated voltage feature of an electromagnet. The default value is 24.

Initial position

Specifies the initial position of the push-pin. The parameter can have one of two values: `Extended` or `Retracted`. The default value is `Retracted`.

In selecting the initial position, consider the following:

- The steady-state push-pin position always corresponds to the control signal. In other words, zero or negative signal keeps the push-pin at `Retracted`, and positive signal — at `Extended`.
- At the start of simulation, if there is a discrepancy between the initial position of the push-pin, as specified by the **Initial position** parameter, and the control signal, the push-pin immediately starts moving towards the steady-state position designated by the control signal.

Actuator orientation

Parameter controls the direction of the push-pin motion and can have one of two values: `Acts in positive direction` or `Acts in negative direction`. The first value causes the push-pin to move in positive direction, similarly to the action of electromagnet A attached to a directional valve. If the parameter is set to `Acts in negative direction`, the control signal causes the push-pin to move in negative direction from the initial position. The default value is `Acts in positive direction`.

Restricted Parameters

When your model is in Restricted editing mode, you cannot modify the following parameters:

- **Initial position**
- **Actuator orientation**

All other block parameters are available for modification.

Ports

The block has one physical signal input port, associated with the input signal, and one physical signal output port, associated with the output signal (push-pin displacement).

Examples

In the “2-Position Valve Actuator” example, the hydraulic circuit contains two actuators. The first one is set to start from the retracted position, while the second one starts from the extended position.

Both actuators are driven with a Pulse Generator. The actuators start extending at 1 s, but the second actuator first retracts from 0.01 m to zero, since it was initially extended and there was no signal keeping it there.

In the “Single-Acting Cylinder with 3-Way Valve” example, the 2-Position Valve Actuator block is used along with a 3-Way Directional Valve block to simulate an electrically operated 3-way directional valve.

Extended Capabilities

C/C++ Code Generation

Generate C and C++ code using Simulink® Coder™.

See Also

3-Position Valve Actuator | Hydraulic Double-Acting Valve Actuator | Hydraulic Single-Acting Valve Actuator | Proportional and Servo-Valve Actuator

Introduced in R2006a

2-Way Directional Valve

Hydraulic continuous 2-way directional valve

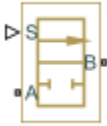

Library

Directional Valves

Description

The 2-Way Directional Valve block represents a continuous, 2-way directional valve, also referred to as a shut-off valve. It is the device that controls the connection between two lines. The block has two hydraulic connections, corresponding to inlet port (A) and outlet port (B), and one physical signal port connection (S), which controls the spool position. The block is built based on a Variable Orifice block, where the **Orifice orientation** parameter is set to **Opens in positive direction**. This means that positive signal x at port S opens the orifice, and its instantaneous opening h is computed as follows:

$$h = x_0 + x$$

where

h	Orifice opening
x_0	Initial opening
x	Control member displacement from initial position

Because the block is based on a variable orifice, you can choose one of the following model parameterization options:

- By **maximum area and opening** — Use this option if the data sheet provides only the orifice maximum area and the control member maximum stroke.
- By **area vs. opening table** — Use this option if the catalog or data sheet provides a table of the orifice passage area based on the control member displacement $A=A(h)$.
- By **pressure-flow characteristic** — Use this option if the catalog or data sheet provides a two-dimensional table of the pressure-flow characteristics $q=q(p, h)$.

In the first case, the passage area is assumed to be linearly dependent on the control member displacement, that is, the orifice is assumed to be closed at the initial position of the control member (zero displacement), and the maximum opening takes place at the maximum displacement. In the second case, the passage area is determined by one-dimensional interpolation from the table $A=A(h)$. Flow rate is determined analytically, which additionally requires data such as flow discharge coefficient, critical Reynolds number, and fluid density and viscosity. The computation accounts for the laminar and turbulent flow regimes by monitoring the Reynolds number and comparing its value

with the critical Reynolds number. See the Variable Orifice block reference page for details. In both cases, a small leakage area is assumed to exist even after the orifice is completely closed. Physically, it represents a possible clearance in the closed valve, but the main purpose of the parameter is to maintain numerical integrity of the circuit by preventing a portion of the system from getting isolated after the valve is completely closed. An isolated or “hanging” part of the system could affect computational efficiency and even cause simulation to fail.

In the third case, when an orifice is defined by its pressure-flow characteristics, the flow rate is determined by two-dimensional interpolation. In this case, neither flow regime nor leakage flow rate is taken into account, because these features are assumed to be introduced through the tabulated data. Pressure-flow characteristics are specified with three data sets: array of orifice openings, array of pressure differentials across the orifice, and matrix of flow rate values. Each value of a flow rate corresponds to a specific combination of an opening and pressure differential. In other words, characteristics must be presented as the Cartesian mesh, i.e., the function values must be specified at vertices of a rectangular array. The argument arrays (openings and pressure differentials) must be strictly increasing. The vertices can be nonuniformly spaced. You have a choice of three interpolation methods and two extrapolation methods.

The block positive direction is from port A to port B. This means that the flow rate is positive if it flows from A to B and the pressure differential is determined as $p = p_A - p_B$. Positive signal at the physical signal port S opens the valve.

Basic Assumptions and Limitations

- Fluid inertia is not taken into account.
- Spool loading, such as inertia, spring, hydraulic forces, and so on, is not taken into account.

Parameters

Model parameterization

Select one of the following methods for specifying the valve:

- **By maximum area and opening** — Provide values for the maximum valve passage area and the maximum valve opening. The passage area is linearly dependent on the control member displacement, that is, the valve is closed at the initial position of the control member (zero displacement), and the maximum opening takes place at the maximum displacement. This is the default method.
- **By area vs. opening table** — Provide tabulated data of valve openings and corresponding valve passage areas. The passage area is determined by one-dimensional table lookup. You have a choice of two interpolation methods and two extrapolation methods.
- **By pressure-flow characteristic** — Provide tabulated data of valve openings, pressure differentials, and corresponding flow rates. The flow rate is determined by two-dimensional table lookup. You have a choice of two interpolation methods and two extrapolation methods.

Valve passage maximum area

Specify the area of a fully opened valve. The parameter value must be greater than zero. The default value is $5e-5 \text{ m}^2$. This parameter is used if **Model parameterization** is set to **By maximum area and opening**.

Valve maximum opening

Specify the maximum displacement of the control member. The parameter value must be greater than zero. The default value is $5e-3$ m. This parameter is used if **Model parameterization** is set to **By maximum area and opening**.

Tabulated valve openings

Specify the vector of input values for valve openings as a one-dimensional array. The input values vector must be strictly increasing. The values can be nonuniformly spaced. The minimum number of values depends on the interpolation method: you must provide at least two values for linear interpolation, at least three values for smooth interpolation. The default values, in meters, are $[-0.002 \ 0 \ 0.002 \ 0.005 \ 0.015]$. If **Model parameterization** is set to **By area vs. opening table**, the **Tabulated valve openings** values will be used together with **Tabulated valve passage area** values for one-dimensional table lookup. If **Model parameterization** is set to **By pressure-flow characteristic**, the **Tabulated valve openings** values will be used together with **Tabulated pressure differentials** and **Tabulated flow rates** for two-dimensional table lookup.

Tabulated valve passage area

Specify the vector of output values for valve passage area as a one-dimensional array. The valve passage area vector must be of the same size as the valve openings vector. All the values must be positive. The default values, in m^2 , are $[1e-09 \ 2.0352e-07 \ 4.0736e-05 \ 0.00011438 \ 0.00034356]$. This parameter is used if **Model parameterization** is set to **By area vs. opening table**.

Tabulated pressure differentials

Specify the vector of input values for pressure differentials as a one-dimensional array. The vector must be strictly increasing. The values can be nonuniformly spaced. The minimum number of values depends on the interpolation method: you must provide at least two values for linear interpolation, at least three values for smooth interpolation. The default values, in Pa, are $[-1e+07 \ -5e+06 \ -2e+06 \ 2e+06 \ 5e+06 \ 1e+07]$. This parameter is used if **Model parameterization** is set to **By pressure-flow characteristic**.

Tabulated flow rates

Specify the flow rates as an m -by- n matrix, where m is the number of valve openings and n is the number of pressure differentials. Each value in the matrix specifies flow rate taking place at a specific combination of valve opening and pressure differential. The matrix size must match the dimensions defined by the input vectors. The default values, in m^3/s , are:

```
[ -1e-07 -7.0711e-08 -4.4721e-08 4.4721e-08 7.0711e-08 1e-07;
  -2.0352e-05 -1.4391e-05 -9.1017e-06 9.1017e-06 1.4391e-05 2.0352e-05;
  -0.0040736 -0.0028805 -0.0018218 0.0018218 0.0028805 0.0040736;
  -0.011438 -0.0080879 -0.0051152 0.0051152 0.0080879 0.011438;
  -0.034356 -0.024293 -0.015364 0.015364 0.024293 0.034356;]
```

This parameter is used if **Model parameterization** is set to **By pressure-flow characteristic**.

Interpolation method

Select one of the following interpolation methods for approximating the output value when the input value is between two consecutive grid points:

- **Linear** — Select this option to get the best performance.
- **Smooth** — Select this option to produce a continuous curve (**By area vs. opening table**) or surface (**By pressure-flow characteristic**) with continuous first-order derivatives.

For more information on interpolation algorithms, see the PS Lookup Table (1D) and PS Lookup Table (2D) block reference pages.

Extrapolation method

Select one of the following extrapolation methods for determining the output value when the input value is outside the range specified in the argument list:

- **Linear** — Select this option to produce a curve or surface with continuous first-order derivatives in the extrapolation region and at the boundary with the interpolation region.
- **Nearest** — Select this option to produce an extrapolation that does not go above the highest point in the data or below the lowest point in the data.

For more information on extrapolation algorithms, see the PS Lookup Table (1D) and PS Lookup Table (2D) block reference pages.

Flow discharge coefficient

Semi-empirical parameter for valve capacity characterization. Its value depends on the geometrical properties of the valve, and usually is provided in textbooks or manufacturer data sheets. The default value is 0.7.

Initial opening

Orifice initial opening. The parameter can be positive (underlapped orifice), negative (overlapped orifice), or equal to zero for zero lap configuration. The default value is 0.

Laminar transition specification

Select how the block transitions between the laminar and turbulent regimes:

- **Pressure ratio** — The transition from laminar to turbulent regime is smooth and depends on the value of the **Laminar flow pressure ratio** parameter. This method provides better simulation robustness.
- **Reynolds number** — The transition from laminar to turbulent regime is assumed to take place when the Reynolds number reaches the value specified by the **Critical Reynolds number** parameter.

Laminar flow pressure ratio

Pressure ratio at which the flow transitions between laminar and turbulent regimes. The default value is 0.999. This parameter is visible only if the **Laminar transition specification** parameter is set to **Pressure ratio**.

Critical Reynolds number

The maximum Reynolds number for laminar flow. The value of the parameter depends on the orifice geometrical profile. You can find recommendations on the parameter value in hydraulics textbooks. The default value is 12, which corresponds to a round orifice in thin material with sharp edges. This parameter is visible only if the **Laminar transition specification** parameter is set to **Reynolds number**.

Leakage area

The total area of possible leaks in the completely closed valve. The main purpose of the parameter is to maintain numerical integrity of the circuit by preventing a portion of the system from getting isolated after the valve is completely closed. The parameter value must be greater than 0. The default value is $1e-12 \text{ m}^2$.

Restricted Parameters

When your model is in Restricted editing mode, you cannot modify the following parameters:

- **Model parameterization**
- **Interpolation method**
- **Extrapolation method**

All other block parameters are available for modification. The actual set of modifiable block parameters depends on the value of the **Model parameterization** parameter at the time the model entered Restricted mode.

Global Parameters

Parameters determined by the type of working fluid:

- **Fluid density**
- **Fluid kinematic viscosity**

Use the Hydraulic Fluid block or the Custom Hydraulic Fluid block to specify the fluid properties.

Ports

The block has the following ports:

A

Hydraulic conserving port associated with the valve inlet.

B

Hydraulic conserving port associated with the valve outlet.

S

Physical signal port to control spool displacement.

Examples

In the “Closed-Loop Actuator with 2-Way Valve” example, the 2-Way Directional Valve block is used to control the position of a double-acting cylinder. At the start of simulation, the valve is open by 0.42 mm to make the circuit initial position as close as possible to its neutral position.

Extended Capabilities

C/C++ Code Generation

Generate C and C++ code using Simulink® Coder™.

See Also

3-Way Directional Valve | 4-Way Directional Valve

Topics

“Upgrading Simscape Fluids Models Containing Hydraulics (Isothermal) Blocks”

Introduced in R2006a

2-Way Directional Valve (IL)

2-way flow control valve in isothermal systems

Library: Simscape / Fluids / Isothermal Liquid / Valves & Orifices / Directional Control Valves

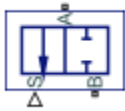

Description

The 2-Way Directional Valve (IL) block represents a two-way valve, such as a shut-off valve. Use this block to simulate a flow-reducing control element that responds to pressures in another part of the system.

The block uses a variable orifice to control the flow between ports **A** and **B**. The physical signal at port **S** triggers the spool motion to open or shut the valve. For more details about how the block calculates flow rate through a variable orifice, see Orifice (IL).

Orifice Parameterizations

You can parameterize the valve opening linearly or by using tabulated data.

Linear

When you set **Orifice parameterization** to Linear - Area vs. spool travel, the opening area is a linear function of the spool travel distance.

$$A_{orifice} = \frac{(A_{max} - A_{leak})}{\Delta S_{max}} \Delta S + A_{leak},$$

where

- $A_{orifice}$ is the opening area.
- ΔS is the spool travel distance input at port **S**. $\Delta S = S - S_{max} + \Delta S_{max}$.
- ΔS_{max} is the value of the **Spool travel between closed and open orifice** parameter.
- A_{Leak} is the value of the **Leakage area** parameter.
- A_{max} is the value of the **Maximum orifice area** parameter.

Note the linear scaling from A_{Leak} to A_{max} in the figure.

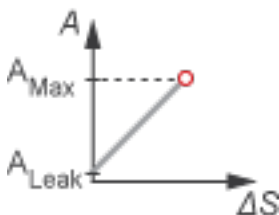

When the valve is in near-open or near-closed position, you can maintain numerical robustness in your simulation by adjusting the block **Smoothing factor**. The block computes the normalized valve area as

$$\hat{A} = \frac{(A_{orifice} - A_{leak})}{(A_{max} - A_{leak})}.$$

The block applies the **Smoothing factor** parameter, s , to smooth the normalized valve area as

$$\hat{A}_{smoothed} = \frac{1}{2} + \frac{1}{2} \sqrt{\hat{A}^2 + \left(\frac{s}{4}\right)^2} - \frac{1}{2} \sqrt{(\hat{A} - 1)^2 + \left(\frac{s}{4}\right)^2}.$$

Lastly, the block scales the smoothed, normalized valve area as

$$A_{smoothed} = \hat{A}_{smoothed}(A_{max} - A_{leak}) + A_{leak}.$$

Tabulated

When you set **Orifice parameterization** to Tabulated data - Area vs. spool travel, the block uses the **Spool travel vector** and **Orifice area vector** parameters to define the relationship between $A_{orifice}$ and ΔS by interpolation. A_{leak} and A_{max} are the first and last parameters of the **Orifice area vector** parameter, respectively.

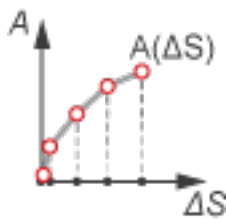

When you set **Orifice parameterization** to Tabulated data - Volumetric flow rate vs. spool travel and pressure drop, the block uses the **Volumetric flow rate table**, $q(\mathbf{ds}, \mathbf{dp})$, **Pressure drop vector**, \mathbf{dp} , and **Spool travel vector**, \mathbf{ds} parameters to define the volumetric flow rate, $q(\Delta S, p)$.

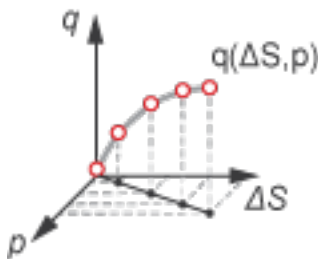

Visualize Orifice Openings

To visualize the spool offsets and displacement, right-click the block and select **Fluids > Plot Valve Characteristics**. The plot shows the valve open area or volumetric flow rate as a function of spool position.

After you apply changes to the block parameters, click **Reload Data** in the figure window.

The figure shows the valve configuration with:

- **Spool position at maximum orifice area** set to 2×10^{-3} m.
- **Spool travel between closed and open orifice** set to 6×10^{-3} m.

All other parameters are at the default values.

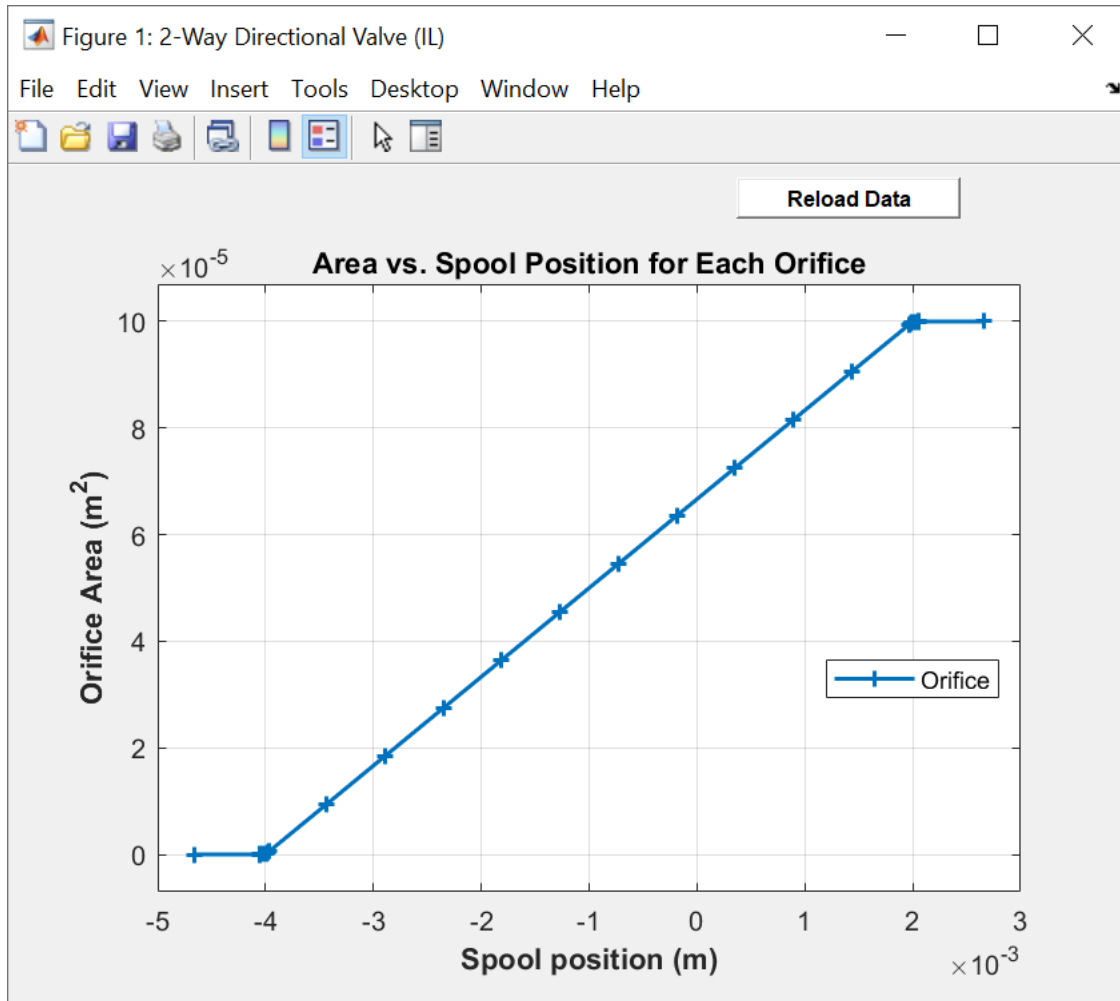

Fault Behavior

When you set **Enable faults** to On, the valve opening stops at a specified spool position in response to how you set the **Fault trigger** parameter:

- **Temporal** — Fault occurs at the time you specify in the **Simulation time for fault event** parameter.
- **External** — Faults occur in response to an external trigger from port **Tr**.

You can choose the type of fault by using the **Spool position when faulted** parameter:

- **Negative** — The block freezes the valve at its smallest value. The table shows which value the block uses depending on the setting of the **Orifice parameterization** parameter.

Orifice parameterization Parameter Setting	Freeze Position Value
Linear - Area vs. spool travel	Leakage area parameter
Tabulated data - Area vs. spool travel	First element of the Orifice area vector parameter
Tabulated data - Volumetric flow rate vs. spool travel and pressure drop	First row of the Volumetric flow rate table, $q(ds,dp)$ parameter

- **Positive** — The valve freezes at its largest value. The table shows which value the block uses depending on the setting of the **Orifice parameterization** parameter.

Orifice parameterization Parameter Setting	Freeze Position Value
Linear - Area vs. spool travel	Maximum opening area parameter
Tabulated data - Area vs. spool travel	Last element of the Orifice area vector parameter
Tabulated data - Volumetric flow rate vs. spool travel and pressure drop	Last row of the Volumetric flow rate table, $q(ds,dp)$ parameter

- **Maintain last value** — The valve freezes at its last value. The table shows which value the block uses depending on the setting of the **Orifice parameterization** parameter.

Orifice parameterization Parameter Setting	Freeze Position Value
Linear - Area vs. spool travel	The valve open area when the trigger occurred
Tabulated data - Area vs. spool travel	The valve open area when the trigger occurred
Tabulated data - Volumetric flow rate vs. spool travel and pressure drop	Current position

Note that when you set **Orifice parameterization** to Tabulated data - Volumetric flow rate vs. spool travel and pressure drop, the volumetric flow rate continues to change according to pressure changes in the valve after the valve freezes.

Due to numerical smoothing at the extremes of the valve area, the block applies a minimum area that is larger than the **Leakage area**, and a maximum that is smaller than the **Maximum orifice area**, in proportion to the **Smoothing factor** value.

After the fault triggers, the valve remains at the faulted area for the rest of the simulation.

Ports

Conserving

A — Liquid port

isothermal liquid

Isothermal liquid conserving port.

B – Liquid port

isothermal liquid

Isothermal liquid conserving port.

Input

S – Spool displacement, m

physical signal

Physical signal associated with the spool displacement, in m. A positive value causes the valve to open.

Tr – External fault trigger

physical signal

Physical signal port associated with the external fault trigger. Triggering occurs when the value is greater than 0.5.

Dependencies

To enable this port, set **Enable faults** to On and **Fault trigger** to External.

Parameters

Model Parameterization

Orifice parameterization – Opening area relationship

Linear - area vs. spool travel (default) | Tabulated data - Area vs. spool travel |
Tabulated data - Volumetric flow rate vs. spool travel and pressure drop

Method the block uses to calculate the valve flow area. To learn more, see “Orifice Parameterizations” on page 1-11.

Spool position at maximum orifice area – Spool offset at maximum area

5e-3 m (default) | positive scalar

Position of the spool travel member when the valve is fully open. The default value represents a zero-lapped system. A positive, nonzero value represents an underlapped, or partially closed, system. A negative, nonzero value represents an overlapped system where the valve remains open over a range of displacements.

Spool travel between closed and open orifice – Maximum spool stroke

5e-3 m (default) | positive scalar

Spool offset at the maximum valve opened area.

Dependencies

To enable this parameter, set **Orifice parametrization** to Linear - area vs. spool travel.

Maximum orifice area – Area of fully open valve

1e-4 m² (default) | positive scalar

Maximum valve area experienced during simulation.

Dependencies

To enable this parameter, set **Orifice parametrization** to Linear - area vs. spool travel.

Leakage area — Valve gap area when in fully closed position

$1e-10 \text{ m}^2$ (default) | positive scalar

Sum of all gaps when the valve is in the fully closed position. The block maintains any area smaller than this value at the specified leakage area. This parameter contributes to numerical stability by maintaining continuity in the flow.

Dependencies

To enable this parameter, set **Orifice parametrization** to Linear - area vs. spool travel.

Spool travel vector — Spool opening distance values

$[0, .002, .004, .007, .017] \text{ m}$ (default) | vector

Vector of control member travel distances. A positive value opens the valve. The values in this vector correspond one-to-one to values in the **Orifice area vector** parameter. The values must ascend from 0. The block interpolates the points linearly.

Dependencies

To enable this parameter, set **Orifice parametrization** to Tabulated data - Area vs. spool travel.

Orifice area vector — Valve opening area values

$[1e-09, 2.0352e-07, 4.0736e-05, .00011438, .00034356] \text{ m}^2$ (default) | vector

Vector of valve area values for the tabular parametrization of opening area. The values in this vector correspond one-to-one with the elements in the **Spool travel vector** parameter. The first element of this vector is the leakage area, and the last element is the maximum valve area. The block interpolates the points linearly.

Dependencies

To enable this parameter, set **Orifice parametrization** to Tabulated data - Area vs. spool travel.

Spool travel vector, ds — Tabular spool opening distance values

$[0, .002, .004, .007, .017] \text{ m}$ (default) | vector

Vector of control member travel distances. The spool travel vector forms an independent axis with the **Pressure drop vector, dp** parameter for the 3-D dependent **Volumetric flow rate table, q(ds,dp)** parameter. A positive displacement corresponds to valve opening. The values ascend from 0. The block interpolates the points linearly.

Dependencies

To enable this parameter, set **Orifice parametrization** to Tabulated data - Volumetric flow rate vs. spool travel and pressure drop.

Pressure drop vector, dp — Tabular pressure drop values

$[.3, .5, .7] \text{ MPa}$ (default) | vector

Vector of pressure drop values for the volumetric flow rate. The pressure drop vector forms an independent axis with the **Spool travel vector, ds** parameter for the 3-D dependent **Volumetric flow rate table, q(ds,dp)** parameter. The values must be positive and ascending. The block interpolates the points linearly

Dependencies

To enable this parameter, set **Orifice parametrization** to Tabulated data - Volumetric flow rate vs. spool travel and pressure drop.

Volumetric flow rate table, q(ds,dp) – Volumetric flow rate for given spool travel and pressure drop

[1.7e-05, 2e-05, 2.6e-05; .0035, .0045, .0053; .7, .9, 1.06; 1.96, 2.5, 3; 6, 7.7, 9.13] m³/s (default) | matrix

M-by-*N* matrix of volumetric flow rates based on independent values of pressure drop and spool travel distance. *M* and *N* are the sizes of the correlated vectors:

- *M* is the number of elements in the **Pressure drop vector, dp** parameter.
- *N* is the number of elements in the **Spool travel vector, ds** parameter.

Dependencies

To enable this parameter, set **Orifice parametrization** to Tabulated data - Volumetric flow rate vs. spool travel and pressure drop.

Discharge coefficient – Discharge coefficient

0.64 (default) | positive scalar

Discharge loss for a hydraulic structure. The default discharge coefficient for an valve in Simscape Fluids is 0.64.

Dependencies

To enable this parameter, set **Orifice parametrization** to either:

- Tabulated data - Area vs. spool travel
- Linear - area vs. spool travel

Critical Reynolds number – Upper Reynolds number limit for laminar flow

150 (default) | positive scalar

Upper Reynolds number limit for laminar flow through the valve.

Dependencies

To enable this parameter, set **Orifice parametrization** to either:

- Tabulated data - Area vs. spool travel
- Linear - area vs. spool travel

Smoothing factor – Numerical smoothing factor

0.01 (default) | positive scalar in the range [0,1]

Continuous smoothing factor that introduces a layer of gradual change based to the flow response when the valve is in near-open and near-closed positions. To increase the stability of your simulation in these regimes, set this parameter to a nonzero value less than one.

Dependencies

To enable this parameter, set **Orifice parametrization** to Linear - area vs. spool travel.

Pressure recovery — Whether to account for pressure increase in area expansions

On (default) | Off

Whether to account for pressure increase when the fluid flows from a region of smaller cross-sectional area to a region of larger cross-sectional area.

Cross-sectional area at ports A and B — Valve area at conserving ports

inf m² (default) | positive scalar

Cross-sectional area at ports **A** and **B**. The block uses this area in the pressure-flow rate equation to determine the volumetric flow rate through the valve.

Dependencies

To enable this parameter, set **Orifice parametrization** to either:

- Tabulated data - Area vs. spool travel
- Linear - area vs. spool travel

Faults**Enable faults — Fault option**

Off (default) | On

Enable externally or temporally triggered faults. When a fault occurs, the block sets the valve area to the value specified in the **Spool position when faulted** parameter.

Spool position when faulted — Set faulted characteristics

Positive (default) | Negative | Maintain last value

Sets the faulted valve spool position. You can choose for the valve to seize when the spool is in the positive position, negative position, or at the position when the fault triggers.

Dependencies

To enable this parameter, set **Enable faults** to On.

Fault trigger — External or temporal trigger option

Temporal (default) | External

Whether a fault occurs due to an external event or at a specified time.

- External — A physical signal at port **Tr** that is greater than 0.5 triggers a fault.
- Temporal — The block sets the valve area to the value specified in the **Spool position when faulted** parameter once the simulation reaches the time specified in the **Simulation time for fault event** parameter.

Dependencies

To enable this parameter, set **Enable faults** to On.

Simulation time for fault event – Time at which faulting is triggered

5 s (default) | positive scalar

Simulation time when fault occurs.

Dependencies

To enable this parameter, set **Enable faults** to On and **Fault trigger** to Temporal.

See Also

3-Way Directional Valve (IL) | 4-Way 3-Position Directional Valve (IL) | Pressure-Compensated 3-Way Flow Control Valve (IL) | Orifice (IL)

Introduced in R2020a

2-Way Directional Valve (G)

Controlled valve with two ports and one flow path

Library: Simscape / Fluids / Gas / Valves & Orifices / Directional Control Valves

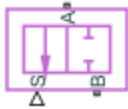

Description

The 2-Way Directional Valve (G) block models a valve with two ports (**A** and **B**) and one flow path (**A-B**). The path runs through an orifice of variable width, the degree of its opening arising from the motion of a control member. Think of the control member as a spool with a land that covers (by degrees) the **A-B** orifice. The distance of the land to the orifice determines if, and to what extent, the orifice is open.

(The distance to the orifice is computed during simulation from the displacement signal specified at port **S**. These variables—in fact, all distances related to spool position—are each defined as a unitless fraction, generally valued between 0 and +1. The calculations are described in detail under “Orifice Opening Fractions” on page 1-20.)

The flow can be laminar or turbulent, and it can reach (up to) sonic speeds. This happens at the vena contracta, a point just past the throat of the valve where the flow is both its narrowest and fastest. The flow then chokes and its velocity saturates, with a drop in downstream pressure no longer sufficing to increase its velocity. Choking occurs when the back-pressure ratio hits a critical value characteristic of the valve. Supersonic flow is not captured by the block.

Valve Positions

The valve is continuously variable. It shifts smoothly between positions, of which it has two: one normal and one working.

The normal position is that to which the valve reverts when it is no longer being operated. The instantaneous displacement of the spool (given at port **S**) is then zero. Unless the land of the spool is installed at an offset to the valve orifice, the valve will be fully closed. The working position is that to which the valve moves when the spool is maximally displaced (in the positive direction) from the normal position. The orifice is then fully open.

What spool displacement puts the valve in its working position depends on the offset of the (land on) the spool. This offset is generally applied before operation in a real valve, and before simulation in a valve model. Its value is specified in the block as a constant named **Valve opening fraction offset**.

Orifice Opening Fractions

Between valve positions, the opening of the **A-B** orifice depends on where, relative to its rim, the land of the spool happens to be. This distance is the orifice opening, and it is normalized here so that its value is a fraction of its maximum (the distance at which is fully open). The normalized variable is referred to as the *orifice opening fraction*.

The orifice opening fraction can range from 0, in the normal position, to 1, in the working position. Its value is calculated from the lengths already alluded to: the variable displacement of the control

member (applied during operation) and the fixed offset of its land (applied during installation). These give for the orifice opening fraction:

$$h_{AB} = H_{AB} + x,$$

where:

- h is the opening fraction for the sole orifice, **A-B**. If the calculation should return a value outside of the range 0-1, the nearest limit is used. (The orifice opening fraction is said to *saturate* at 0 and 1.)
- H is the opening fraction offset, specified as a block parameter (named **Valve opening fraction offset**). To allow for unusual valve configurations, no limit is imposed on its value, though generally it will fall between -1 and +1.
- x is the normalized instantaneous displacement of the spool, specified as a physical signal at port **S**. To compensate for equally extreme opening fraction offsets, no limit is imposed on its value (though generally it too will fall near the range of 0 and 1).

Opening Fraction Offsets

The valve is by default configured so that it is fully closed when its control displacement is zero. Such a valve is often described as being zero-lapped.

It is possible, by offsetting the land of the spool, to model a valve that is underlapped (partially open in the normal valve position) or overlapped (fully closed not only *in* but slightly *beyond* the normal position). The figure shows, for each case, how the orifice opening fraction varies with the spool displacement:

- **Case I:** A zero-lapped valve. The opening fraction offset is zero. When the valve is in the normal position, the land of the spool completely covers the orifice.
- **Case II:** An underlapped valve. The opening fraction offset is positive. When the valve is in the normal position, the land of the spool covers the orifice, but not fully.
- **Case III:** An overlapped valve. The opening fraction offset is negative. The land of the spool completely covers the orifice not only in the normal position but also over a small region (of spool displacements) around it.

I.

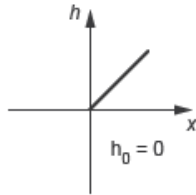

II.

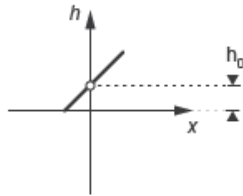

III.

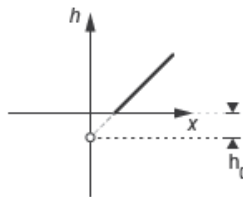

Control Position in Zero-Lapped, Underlapped, and Overlapped valves

Opening Characteristics

It is common, when picking a valve for throttling or control applications, to match the flow characteristic of the valve to the system it is to regulate.

The flow characteristic relates the opening of the valve to the input that produces it, often spool travel. Here, the opening is expressed as a sonic conductance, flow coefficient, or restriction area (the choice between these being given in the **Valve parameterization** setting). The control input is the orifice opening fraction (a function of the spool displacement specified at port S).

The flow characteristic is normally given at steady state, with the inlet at a constant, carefully controlled pressure. This (inherent) flow characteristic depends only on the valve and it can be linear or nonlinear, the most common examples of the latter being the quick-opening and equal-percentage types. To capture such flow characteristics, the block provides a choice of opening parameterization (specified in the block parameter of the same name):

- **Linear** — The sonic conductance (C) is a linear function of the orifice opening fraction (h). In the default valve parameterization of **Sonic conductance**, the end points of the line are obtained at opening fractions of 0 and 1 from the **Sonic conductance and leakage flow** and **Sonic conductance at maximum flow** block parameters.

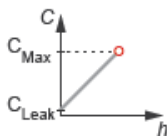

- **Tabulated data** — The sonic conductance is a general function (linear or nonlinear) of the orifice opening fraction. The function is specified in tabulated form, with the columns of the table deriving, in the default valve parameterization, from the **Opening fraction vector** and **Sonic conductance vector** block parameters.

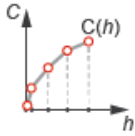

(If the **Valve parameterization** setting is other than **Sonic conductance**, the sonic conductance data is obtained by conversion from the chosen measure of valve opening—such as restriction area or flow coefficient.)

For controlled systems, it is important that the valve, once it is installed, be approximately linear in its flow characteristic. This (installed) characteristic depends on the remainder of the system—it is not generally the same as the inherent characteristic captured in the block. A pump, for example, may have a nonlinear characteristic that only a nonlinear valve, usually of the equal-percentage type, can adequately compensate for. It is cases of this sort that the **Tabulated data** option primarily targets.

Leakage Flow

The main purpose of leakage flow is to ensure that no section of a fluid network ever becomes isolated from the rest. Isolated fluid sections can reduce the numerical robustness of the model, slowing down the rate of simulation and, in some cases, causing it to fail altogether. While leakage flow is generally present in real valves, its exact value here is less important than its being a small number greater than zero. The leakage flow area is given in the block parameter of the same name.

Composite Structure

This block is a composite component comprising a single Variable Orifice ISO 6358 (G) block connected to ports **A**, **B**, and **S** as shown below. Refer to that block for more detail on the valve parameterizations and block calculations (for example, those used to determine the mass flow rate through the ports).

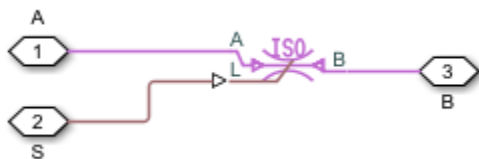

Ports

Input

S — Valve control signal, unitless

physical signal

Instantaneous displacement of the control member against its normal (unactuated) position, specified as a physical signal. The displacement is normalized against the maximum position of the control

member (that required to open the orifice fully). See the block description for more information. The signal is unitless and its instantaneous value typically (though not always) in the range of 0-1.

Conserving

A — Valve opening

gas

Opening through which flow can enter or exit the valve.

B — Valve opening

gas

Opening through which flow can enter or exit the valve.

Parameters

Valve parameterization — Method by which to characterize the opening of the valve

Sonic conductance (default) | Cv coefficient (USCS) | Kv coefficient (SI) |
Restriction area

Choice of ISO method to use in the calculation of mass flow rate. All calculations are based on the Sonic conductance parameterization; if a different option is selected, the data specified is converted into equivalent sonic conductance, critical pressure ratio, and subsonic index. See the calculations of the Variable Orifice ISO 6358 (G) block for detail on the conversions.

Opening parameterization — Method by which to calculate the opening characteristics of the valve

Linear (default) | Tabulated data

Method by which to calculate the opening area of the valve. The default setting treats the opening area as a linear function of the orifice opening fraction. The alternative setting allows for a general, nonlinear relationship to be specified (in tabulated form).

Sonic conductance at maximum flow — Measure of maximum flow rate at reference upstream conditions

1.6 l/s/bar (default) | positive scalar in units of volume/time/pressure

Equivalent measure of the maximum flow rate through the valve at some reference inlet conditions, generally those outlined in ISO 8778. The flow is at a maximum when the valve is fully open and the flow velocity is choked (it being saturated at the local speed of sound). This is the value usually reported by manufacturers in technical data sheets.

Sonic conductance is defined as the ratio of the mass flow rate through the valve to the product of the pressure and density upstream of the valve inlet. This parameter is often referred to as the *C-value*.

Dependencies

This parameter is active and exposed in the block dialog box when the **Valve parameterization** setting is Sonic conductance.

Sonic conductance at leakage flow — Measure of minimum flow rate at reference upstream conditions

1e-5 l/s/bar (default) | positive scalar in units of volume/time/pressure

Equivalent measure of the minimum flow rate allowed through the valve at some reference inlet conditions, generally those outlined in ISO 8778. The flow is at a minimum when the valve is maximally closed and only a small leakage area—due to sealing imperfections, say, or natural valve tolerances—remains between its ports.

Sonic conductance is defined as the ratio of the mass flow rate through the valve to the product of the pressure and density upstream of the valve inlet. This parameter is often referred to in the literature as the *C-value*.

This parameter serves primarily to ensure that closure of the valve does not cause portions of the gas network to become isolated (a condition known to cause problems in simulation). The exact value specified here is less important than its being a (very small) number greater than zero.

Dependencies

This parameter is active and exposed in the block dialog box when the **Valve parameterization** setting is Sonic conductance.

Critical pressure ratio — Back-pressure ratio, at reference upstream conditions, at which the flow rate is a maximum

0.3 (default) | positive and unitless scalar

Ratio of downstream to upstream absolute pressures at which the flow becomes choked (and its velocity becomes saturated at the local speed of sound). This parameter is often referred to in the literature as the *b-value*. Enter a number greater than or equal to zero and smaller than the **Laminar flow pressure ratio** block parameter.

Dependencies

This parameter is active and exposed in the block dialog box when the **Valve parameterization** setting is Sonic conductance.

Subsonic index — Exponent used to more accurately characterize flow in the subsonic regime

0.5 (default) | positive unitless scalar

Empirical exponent used to more accurately calculate the mass flow rate through the valve when the flow is subsonic. This parameter is sometimes referred to as the *m-index*. Its value is approximately 0.5 for valves (and other components) whose flow paths are fixed.

Dependencies

This parameter is active and exposed in the block dialog box when the **Valve parameterization** setting is Sonic conductance.

Cv coefficient (USCS) at maximum flow — Flow coefficient of the fully open valve expressed in US customary units

0.4 (default) | positive scalar in units of ft³/min

Flow coefficient of the fully open valve, expressed in the US customary units of ft³/min (as described in NFPA T3.21.3). This parameter measures the relative ease with which the gas will traverse the valve when driven by a given pressure differential. This is the value generally reported by manufacturers in technical data sheets.

Dependencies

This parameter is active and exposed in the block dialog box when the **Valve parameterization** setting is **Cv coefficient (USCS)**.

Cv coefficient (USCS) at leakage flow — Flow coefficient of the maximally closed valve expressed in US customary units

1e-6 (default) | positive scalar in units of ft³/min

Flow coefficient of the maximally closed valve, expressed in the US customary units of ft³/min (as described in NFPA T3.21.3). This parameter measures the relative ease with which the gas will traverse the valve when driven by a given pressure differential.

The purpose of the leakage value is primarily to ensure that closure of the valve does not cause portions of the gas network to become isolated (a condition known to cause problems in simulation). The exact value specified here is less important than its being a (very small) number greater than zero.

Dependencies

This parameter is active and exposed in the block dialog box when the **Valve parameterization** setting is **Cv coefficient (USCS)**.

Kv coefficient (SI) at maximum flow — Flow coefficient of the fully open valve expressed in SI units

0.3 (default) | positive scalar in units of m³/hr

Flow coefficient of the fully open valve, expressed in the SI units of m³/hr. This parameter measures the relative ease with which the gas will traverse the valve when driven by a given pressure differential. This is the value generally reported by manufacturers in technical data sheets.

Dependencies

This parameter is active and exposed in the block dialog box when the **Valve parameterization** setting is **Kv coefficient (SI)**.

Kv coefficient (SI) at leakage flow — Flow coefficient of the maximally closed valve expressed in SI units

1e-6 (default) | positive scalar in units of m³/hr

Flow coefficient of the maximally closed valve, expressed in the SI units of m³/hr. This parameter measures the relative ease with which the gas will traverse the valve when driven by a given pressure differential.

The purpose of the leakage value is primarily to ensure that closure of the valve does not cause portions of the gas network to become isolated (a condition known to cause problems in simulation). The exact value specified here is less important than its being a (very small) number greater than zero.

Dependencies

This parameter is active and exposed in the block dialog box when the **Valve parameterization** setting is **Kv coefficient (SI)**.

Restriction area at maximum flow — Opening area in the fully open position due to sealing imperfections

1e-4 m² (default) | positive scalar in units of area

Value of the flow area at the point of shortest aperture when the control signal specified at port **L** is 1. The cross-sectional area available for flow is then at a maximum. During simulation the flow area at intermediate control signals (those valued between 0 and 1) is set by linear interpolation between this value and that of the **Restriction area at leakage flow** parameter.

Dependencies

This parameter is active and exposed in the block dialog box when the **Valve parameterization** setting is **Restriction area**.

Restriction area at leakage flow — Opening area in the maximally closed position due to sealing imperfections

1e-10 (default)

Opening area of the valve in the maximally closed position, when only internal leakage between the ports remains. This parameter serves primarily to ensure that closure of the valve does not cause portions of the gas network to become isolated (a condition known to cause problems in simulation). The exact value specified here is less important than its being a (very small) number greater than zero.

Dependencies

This parameter is active and exposed in the block dialog box when the **Valve parameterization** setting is **Restriction area**.

Opening fraction vector — Orifice opening fractions at which to specify valve opening data

0 : 0.2 : 1 (default) | unitless vector with elements in the 0-1 range

Orifice opening fractions at which to specify the chosen measure of valve opening—sonic conductance, flow coefficient (in SI or USCS forms), or opening area.

This vector must be equal in size to that (or *those*, in the **Sonic conductance** parameterization) containing the valve opening data. The vector elements must be positive and increase monotonically in value from left to right.

Dependencies

This parameter is active and exposed in the block dialog box when the **Opening parameterization** setting is **Tabulated data**.

Sonic conductance vector — Vector of sonic conductances at given orifice opening fractions

[1e-05, .32, .64, .96, 1.28, 1.6] l/s/bar (default) | vector with units of volume/time/pressure

Sonic conductances at the breakpoints given in the **Opening fraction vector** parameter. This data forms the basis for a tabulated function relating the orifice opening fraction, sonic conductance, and critical pressure ratio. Linear interpolation is used within the tabulated data range; nearest-neighbor extrapolation is used outside of it. The two vectors—of sonic conductance and orifice opening fractions—must be of the same size.

Dependencies

This parameter is active and exposed in the block dialog box when the **Valve parameterization** setting is **Sonic conductance** and the **Opening parameterization** setting is **Tabulated data**.

Critical pressure ratio vector – Vector of critical pressure ratios at given orifice opening fractions

0.3 * ones(1, 6) (default) | unitless vector

Critical pressure ratios at the breakpoints given in the **Opening fraction vector** parameter. This data forms the basis for a tabulated function relating the orifice opening fraction, sonic conductance, and critical pressure ratio. Linear interpolation is used within the tabulated data range; nearest-neighbor extrapolation is used outside of it. The two vectors—of critical pressure ratios and orifice opening fractions—must be of the same size.

The values specified here must each be greater than or equal to zero and smaller than the **Laminar flow pressure ratio** block parameter.

Dependencies

This parameter is active and exposed in the block dialog box when the **Valve parameterization** setting is **Sonic conductance** and the **Opening parameterization** setting is **Tabulated data**.

Cv coefficient (USCS) vector – Vector of flow coefficients, in USCS units, at given orifice opening fractions

[1e-06, .08, .16, .24, .32, .4] (default) | vector in units of ft³/min

Flow coefficients, expressed in US customary units of ft³/min, at the breakpoints given in the **Opening fraction vector**. This data forms the basis for a tabulated function relating the two variables. Linear interpolation is used within the tabulated data range; nearest-neighbor extrapolation is used outside of it. The two vectors—of flow coefficients and orifice opening fractions—must be of the same size.

Dependencies

This parameter is active and exposed in the block dialog box when the **Valve parameterization** setting is **Cv coefficient (USCS)** and the **Opening parameterization** setting is **Tabulated data**.

Kv coefficient (SI) vector – Vector of flow coefficients, in SI units, at given orifice opening fractions

[1e-06, .06, .12, .18, .24, .3] (default) | vector in units of m³/hr

Flow coefficients, expressed in SI units of m³/min, at the breakpoints given in the **Opening fraction vector** parameter. This data forms the basis for a tabulated function relating the two variables. Linear interpolation is used within the tabulated data range; nearest-neighbor extrapolation is used outside of it. The two vectors—of flow coefficients and orifice opening fractions—must be of the same size.

Dependencies

This parameter is active and exposed in the block dialog box when the **Valve parameterization** setting is **Kv coefficient (SI)** and the **Opening parameterization** setting is **Tabulated data**.

Restriction area vector – Vector of opening areas at given orifice opening fractions

[1e-10, 2e-06, 4e-06, 6e-06, 8e-06, 1e-05] m² (default) | vector in units of area

Opening areas at the breakpoints given in the **Opening fraction vector** parameter. This data forms the basis for a tabulated function relating the two variables. Linear interpolation is used within the tabulated data range; nearest-neighbor extrapolation is used outside of it. The two vectors—of opening areas and orifice opening fractions—must be of the same size.

Dependencies

This parameter is active and exposed in the block dialog box when the **Valve parameterization** setting is `Restriction area` and the **Opening parameterization** setting is `Tabulated data`.

Valve opening fraction offset — Opening fraction of the valve at a zero displacement signal

0 (default) | unitless scalar

Opening fraction of the valve when the spool displacement is zero. The valve is then in the normal position. The opening fraction measures the distance between the land of the spool and the orifice of the valve, normalized by the maximum allowed.

Cross-sectional area at ports A and B — Area normal to the flow path at the valve ports

0.01 m² (default) | positive scalar in units of area

Area normal to the flow path at the valve ports. The ports are assumed to be of the same size. The flow area specified here should (ideally) match those of the inlets of adjoining components.

Smoothing factor — Amount of smoothing to apply to the valve opening function

0 (default) | positive unitless scalar

Amount of smoothing to apply to the opening function of the valve. This parameter determines the widths of the regions to be smoothed—one located at the fully open position, the other at the fully closed position.

The smoothing superposes on each region of the opening function a nonlinear segment (a third-order polynomial function, from which the smoothing arises). The greater the value specified here, the greater the smoothing is, and the broader the nonlinear segments become. See the Variable Orifice ISO 6358 (G) block for the impact of the smoothing on the block calculations.

At the default value of 0, no smoothing is applied. The transitions to the maximally closed and fully open positions then introduce discontinuities (associated with zero-crossings). These can slow down the rate of simulation.

Laminar flow pressure ratio — Pressure ratio at which the flow transitions between laminar and turbulent regimes

0.999 (default) | positive unitless scalar

Pressure ratio at which the flow transitions between laminar and turbulent flow regimes. The pressure ratio is the fraction of the absolute pressure downstream of the valve over that just upstream of it. The flow is laminar when the actual pressure ratio is above the threshold specified here and turbulent when it is below. Typical values range from 0.995 to 0.999.

Reference temperature — ISO 8778 reference temperature

293.15 K (default) | scalar in units of temperature

Temperature at standard reference atmosphere, defined as 293.15 K in ISO 8778.

Reference density – ISO 8778 reference density

1.185 (default) | positive scalar in units of mass/volume

Density at standard reference atmosphere, defined as 1.185 kg/m³ in ISO 8778.

Extended Capabilities

C/C++ Code Generation

Generate C and C++ code using Simulink® Coder™.

See Also

Variable Orifice ISO 6358 (G) | 2-Way Directional Valve (G) | 3-Way Directional Valve (G) | 4-Way Directional Valve (G)

Introduced in R2018b

2-Way Directional Valve (TL)

Valve for modulating flow between two thermal liquid nodes

Library: Simscape / Fluids / Thermal Liquid / Valves & Orifices / Directional Control Valves

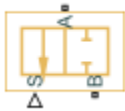

Description

The 2-Way Directional Valve (TL) block models the flow through a directional control valve with two ports (**A** and **B**) and one flow path (**A-B**). The path contains a variable orifice, which scales in proportion to the displacement of a control member—often a ball, spool, or diaphragm, associated with the signal at port **S**. Valves of this type serve as switches by which to modulate flow in a single line, for example to discharge flow from a tank. The valve model is based on the Variable Area Orifice (TL) block and it shares the equations described for that block.

Valve Positions

The valve is continuously variable. It shifts smoothly between positions, of which it has two. One—the *normal* position—is that to which the valve reverts when its control signal falls to zero. Unless an opening offset has been specified, the **A-B** orifice is always fully closed in this position. Another—the *working* position—is that to which the valve moves when its control signal rises to a maximum. The orifice is generally fully open in this position. Note that whether the orifice is in fact open and how open it is both depend on the opening offsets of the valve.

Valve Opening

Which position the valve is in depends on the control member coordinate relative to the **A-B** orifice—a length referred to here as the *orifice opening*. The orifice opening is calculated during simulation from the opening offset, specified via the block parameter of the same name, and from the control member displacement, given by the physical signal at port **S**:

$$h_{AB} = h_{AB0} + x,$$

where:

- h_{AB} is the **A-B** orifice opening.
- h_{AB0} is the **A-B** opening offset.
- x is the control member displacement.

A control member displacement of zero corresponds to a valve that is in its normal position. The **A-B** orifice cracks opens when the opening variable (h_{AB}) rises above zero. It then continues to widen with an increasing orifice opening—and therefore with an increasing control member displacement.

The orifice is fully open when its orifice opening is at a specified maximum. In the linear valve parameterization, this maximum is obtained from the **Maximum valve opening** block parameter. In

the tabulated valve parameterizations, the maximum opening is obtained from the last breakpoint in the tabulated data.

Opening Offsets

The valve is by default configured so that it is fully closed when the control member displacement is zero. Such a valve is often described as being zero-lapped. It is possible, by applying an offset to the control member, to model a valve that is underlapped (partially open when the control member displacement is zero) or overlapped (fully closed up to a control member displacement equal to the applied offset). The figure shows the orifice opening as a function of the control member displacement for each case:

- Case **I**: A zero-lapped valve. The opening offset is zero. When the valve is in the normal position, the control member completely covers the orifice. The zero-lapped valve is completely closed when the control member displacement falls below zero.
- Case **II**: An underlapped valve. The opening offset is positive. When the valve is in the normal position, the control member covers the orifice but not fully. The underlapped valve is partially open until the control member displacement falls below the negated value of the offset.
- Case **III**: An overlapped valve. The opening offset is negative. The control member completely covers the orifice not only in the normal position but over a small region around it. The overlapped valve is fully closed until the control member crosses the opening offset specified for the orifice.

I.

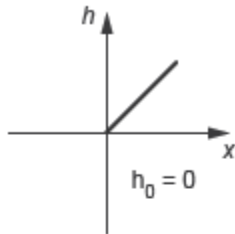

II.

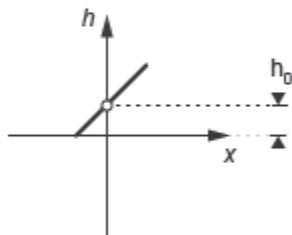

III.

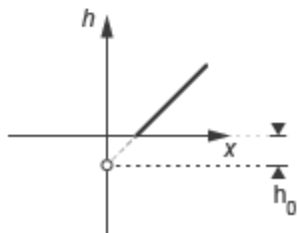

Opening Characteristics

The orifice opening serves during simulation to calculate the mass flow rate through the orifice. The calculation can be a direct mapping from opening to flow rate or an indirect conversion, first from opening to orifice area and then from orifice area to mass flow rate. The calculation, and the data required for it, depend on the setting of the **Valve parameterization** block parameter:

- **Linear area-opening relationship** — Calculate the valve opening area from the control member position and from it obtain the mass flow rate through the valve. The opening area is assumed to vary linearly with the control member position. The slope of the linear expression is determined from the **Maximum valve opening** and **Maximum opening area** block parameters.

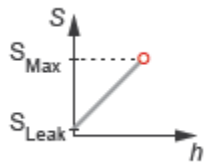

- **Tabulated data - Area vs. opening** — Calculate the valve opening area from the control member position and from it obtain the mass flow rate through the valve. The opening area can vary nonlinearly with the control member position. The relationship between the two is given by the tabulated data in the **Valve opening vector** and **Opening area vector** block parameters.

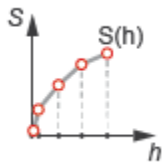

- **Tabulated data - Mass flow rate vs. opening and pressure drop** — Calculate the mass flow rate directly from the control member position and the pressure drop across the valve. The relationship between the three variables can be nonlinear and it is given by the tabulated data in the **Valve opening vector**, **Pressure drop vector**, and **Mass flow rate table** block parameters.

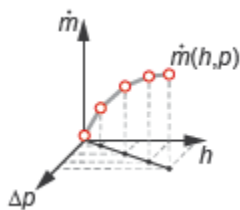

Leakage Flow

The primary purpose of the leakage flow rate of a closed valve is to ensure that at no time a portion of the thermal liquid network becomes isolated from the remainder of the model. Such isolated portions reduce the numerical robustness of the model and can slow down simulation or cause it to fail.

Leakage flow is generally present in real valves but in a model its exact value is less important than its being a small number greater than zero. The leakage flow rate is determined from the **Leakage area** block parameter.

Pressure Loss and Recovery

The pressure drop in the valve is calculated from an empirical parameter known as the discharge coefficient (obtained from the **Discharge coefficient** block parameter). The calculation captures the effect of flow regime, with the pressure drop being proportional to the mass flow rate when the flow is laminar and to the square of the same when the flow is turbulent. Also captured is the pressure recovery than in real valves occurs between the vena contracta (the narrowest aperture of the valve) and the outlet, which generally lies a small distance away.

Composite Component Structure

This block is a composite component comprising a single Variable Area Orifice (TL) block arranged as shown in the figure. The **Orifice orientation** block parameters are set so that a positive signal acts to open the orifice. The specified opening offset is applied to this block. Refer to the Variable Area Orifice (TL) block for detail on the opening area calculations.



Ports

Input

S – Control member displacement, unitless

physical signal

Instantaneous displacement of the valve control member.

Conserving

A – Flow passage

thermal liquid

Opening through which the flow can enter or exit the valve.

B – Flow passage

thermal liquid

Opening through which the flow can enter or exit the valve.

Parameters

Valve parameterization – Method by which to model the opening characteristics of the valve

Linear area-opening relationship (default) | Tabulated data - Area vs. opening |
Tabulated data - Mass flow rate vs. opening and pressure drop

Method by which to model the opening characteristics of the valve. The default setting prescribes a linear relationship between the valve opening area and the valve opening. The alternative settings

allow for a general, nonlinear relationship to be specified in tabulated form, in one case between the opening area and the control member position (the valve opening), in the other case between the mass flow rate and both the valve opening and the pressure drop between the ports.

Maximum valve opening — Control member position at which the opening area is at a maximum

5e-3 m (default) | positive scalar in units of length

Control member position at which the valve is fully open and its opening area is therefore at a maximum. This parameter is used to calculate the slope of the linear expression relating the opening area to the control member position (the valve opening).

Dependencies

This parameter is active when the **Valve parameterization** block parameter is set to Linear area-opening relationship.

Maximum opening area — Opening area of the valve in the fully open position

1e-4 m² (default) | positive scalar in units of area

Opening area of the valve in the fully open position, when the control member is at the position specified in the **maximum valve opening** block parameter. This parameter is used to calculate the slope of the linear expression relating the opening area to the control member position (the valve opening).

Dependencies

This parameter is active when the **Valve parameterization** block parameter is set to Linear area-opening relationship.

Leakage area — Opening area of the valve in the maximally closed position

1e-10 m² (default) | positive scalar in units of area

Opening area of the valve in the fully closed position, when only internal leakage between its ports remains. This parameter serves primarily to ensure that closure of the valve does not cause portions of the thermal liquid network to become isolated. The exact value specified here is less important than its being a small number greater than zero.

Dependencies

This parameter is active when the **Valve parameterization** block parameter is set to Linear area-opening relationship.

Smoothing factor — Measure of the amount of smoothing to apply to the opening area function

0.01 (default) | positive unitless scalar

Measure of the amount of smoothing to apply to the opening area function. This parameter determines the widths of the regions to be smoothed, one being at the fully open position, the other at the fully closed position. The smoothing superposes on the linear opening area function two nonlinear segments, one for each region of smoothing. The greater the value specified, the greater the smoothing and the broader the nonlinear segments.

Dependencies

This parameter is active when the **Valve parameterization** block parameter is set to Linear area-opening relationship.

Valve opening vector — Vector of control member positions at which to tabulate the valve opening areas

[-0.002, 0, 0.002, 0.005, 0.015] m (default) | vector of positive numbers in units of length

Vector of control member positions at which to specify—dependent on the valve parameterization—the opening area of the valve or its mass flow rate. The vector elements must increase monotonically from left to right. This vector must be equal in size to that specified in the **Opening area vector** block parameter or to the number of rows in the **Mass flow rate table** block parameter.

This data serves to construct a one-way lookup table by which to determine, from the control member position, the opening area of the valve or a two-way lookup table by which to determine, from the control member position and pressure drop, the mass flow rate of the valve. Data is handled with linear interpolation (within the tabulated data range) and nearest-neighbor extrapolation (outside of the data range).

Dependencies

This parameter is active when the **Valve parameterization** block parameter is set to Tabulated data - Area vs. opening.

Opening area vector — Vector of opening areas at the specified valve opening breakpoints

[1e-09, 2.0352e-07, 4.0736e-05, 0.00011438, 0.00034356] m² (default) | vector of positive numbers in units of area

Vector of opening areas corresponding to the breakpoints defined in the **Valve opening vector** block parameter. The vector elements must increase monotonically from left to right (with increasing control member position). This vector must be equal in size to the number of valve opening breakpoints.

This data serves to construct a one-way lookup table by which to determine from the control member position the opening area of the valve. Data is handled with linear interpolation (within the tabulated data range) and nearest-neighbor extrapolation (outside of the data range).

Dependencies

This parameter is active when the **Valve parameterization** block parameter is set to Tabulated data - Area vs. opening.

Pressure drop vector — Vector of pressure drops at which to tabulate the mass flow rates

[-0.1, 0.3, 0.5, 0.7] MPa (default) | vector in units of pressure

Vector of pressure differentials from port **A** to port **B** at which to specify the mass flow rate of the valve. The vector elements must increase monotonically from left to right. This vector must be equal in size to the number of columns in the **Mass flow rate table** block parameter.

This data serves to construct a two-way lookup table by which to determine, from the control member position and pressure drop, the opening area of the valve. Data is handled with linear interpolation (within the tabulated data range) and nearest-neighbor extrapolation (outside of the data range).

Dependencies

This parameter is active when the **Valve parameterization** block parameter is set to Tabulated data - Mass flow rate vs. opening and pressure drop.

Mass flow rate table — Matrix of mass flow rates at the specified valve opening and pressure drop breakpoints

[-1e-05, 1.7e-05, 2e-05, 2.6e-05; -.002, .0035, .0045, .0053; -.4, .7, .9, 1.06; -1.13, 1.96, 2.5, 3; -3.45, 6, 7.7, 9.13] kg/s (default) | matrix in units of mass/time

Matrix of mass flow rates corresponding to the breakpoints defined in the **Valve opening vector** and **Pressure drop vector** block parameters. The control member position increases from row to row from top to bottom. The pressure drop increases from column to column from left to right. The mass flow rate must increase monotonically in the same directions (with increasing control member position and increasing pressure drop).

This data serves to construct a two-way lookup table by which to determine, from the control member position and pressure drop, the opening area of the valve. Data is handled with linear interpolation (within the tabulated data range) and nearest-neighbor extrapolation (outside of the data range). Ensure that the number of rows is equal to the size of the **Opening area vector** block parameter and that the number of columns is equal to the size of the **Pressure drop vector** block parameter.

Dependencies

This parameter is active when the **Valve parameterization** block parameter is set to Tabulated data - Mass flow rate vs. opening and pressure drop.

Reference inflow temperature — Inlet temperature at which to specify the tabulated data

293.15 K (default) | positive scalar in units of temperature

Nominal inlet temperature, with reference to absolute zero, at which to specify the tabulated data. This parameter is used to adjust the mass flow rate according to the temperature measured during simulation.

Dependencies

This parameter is active when the **Valve parameterization** block parameter is set to Tabulated data - Mass flow rate vs. opening and pressure drop.

Reference inflow pressure — Inlet pressure at which to specify the tabulated data

0.101325 MPa (default) | positive scalar in units of pressure

Nominal inlet pressure, with reference to absolute zero, at which to specify the tabulated data. This parameter is used to adjust the mass flow rate according to the pressure measured during simulation.

Dependencies

This parameter is active when the **Valve parameterization** block parameter is set to Tabulated data - Mass flow rate vs. opening and pressure drop.

Valve opening offset — Distance by which to displace the control member in the normal valve position

0 m (default) | positive scalar in units of length

Offset between the control member and the location at which, in the normal orifice position, it would completely cover the orifice. Specify a positive offset to model an underlapped orifice or a negative offset to model an overlapped orifice. For detail on how the opening offsets impact the block calculations, see the block description.

Cross-sectional area at ports A and B — Flow area at the thermal liquid ports

0.01 m (default) | positive scalar in units of area

Area normal to the flow path at each port. The ports are assumed to be equal in size. The flow area specified here should match those of the inlets of those components to which the valve connects.

Characteristic longitudinal length — Measure of the length of the flow path through the valve

0.1 (default) | positive scalar in units of length

Average distance traversed by the fluid as it travels from inlet to outlet. This distance is used in the calculation of the internal thermal conduction that occurs between the two ports (as part of the smoothed upwind energy scheme employed in the thermal liquid domain).

Discharge coefficient — Empirical factor defined as the ratio of actual to ideal mass flow rates

0.7 (default) | positive unitless scalar

Ratio of the actual flow rate through the valve to the theoretical value that it would have in an ideal valve. This semi-empirical parameter measures the flow allowed through the valve: the greater its value, the greater the flow rate. Refer to the valve data sheet, if available, for this parameter.

Critical Reynolds number — Reynolds number at the boundary between laminar and turbulent flow regimes

12 (default) | positive unitless scalar

Reynolds number at which the flow is assumed to transition between laminar and turbulent regimes.

Extended Capabilities**C/C++ Code Generation**

Generate C and C++ code using Simulink® Coder™.

See Also

Variable Area Orifice (TL) | 3-Way Directional Valve (TL) | 4-Way Directional Valve (TL) | Check Valve (TL)

Introduced in R2016a

3-Position Valve Actuator

Actuator for three-position valves



Library

Valve Actuators

Description

The 3-Position Valve Actuator block represents an actuator that you can use with directional valves to control their position. This actuator can drive a three-position valve. The block is developed as a data-sheet-based model and all its parameters are generally provided in catalogs or data sheets. The key parameters are the stroke, switch-on, and switch-off times.

The block has two signal inputs associated with the activation signals for electromagnets A or B. It produces a physical output signal that can be associated with a mechanical translational or rotational push-pin motion. Connect the block output to the directional valve control port.

The actuator is represented as an ideal transducer, where output does not depend on the load exerted on the push-pin and the push-pin motion profile remains the same under any loading conditions. The motion profile represents a typical transition curve for electromagnetic actuators. The following figure shows the motion profile for a case when the input signal is applied long enough for the push-pin to reach the end of the stroke (x_{str}), and then the input signal is removed, causing the push-pin to return to initial position:

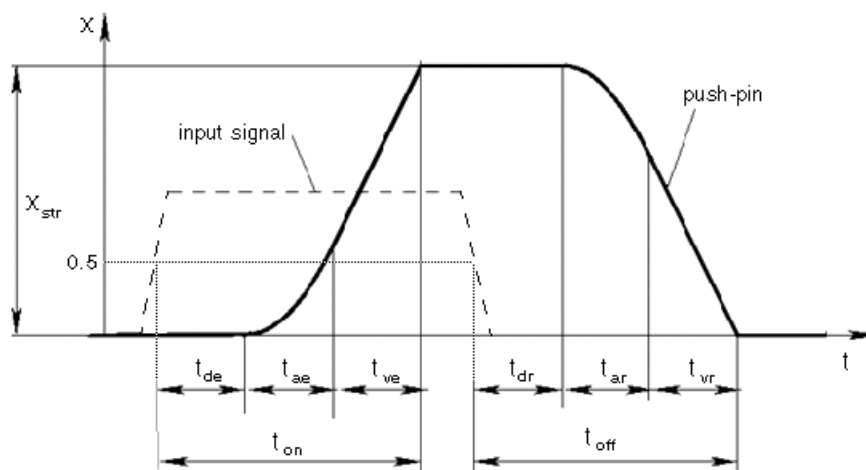

The push-pin is actuated when the input signal value crosses the threshold of 50% of the nominal input signal, where **Nominal signal value** is a block parameter. The motion is divided into three phases, equal in time: delay (t_{de}), motion at constant acceleration (t_{ae}), and motion at constant

velocity (t_{ve}). The motion stops when the switch-on time (t_{on}) elapses. At this moment, the push-pin reaches the specified stroke value (x_{str}). To return the push-pin into initial position, the control signal must be removed, which causes the push-pin to retract. The retract motion also consists of three phases, equal in time: delay (t_{dr}), motion at constant acceleration (t_{ar}), and motion at constant velocity (t_{vr}). It follows exactly the same profile but “stretches” over the switch-off time. **Switching-on time** and **Switching-off time** are the block parameters.

The signal applied to port A causes the output to move in positive direction. To shift the push-pin in negative direction, you must apply the signal to port B. Only one control signal can be applied at a time. This means that if the actuator is being controlled by the signal at port A, the push-pin must be allowed to return to initial position before the control signal at port B can be processed. The transition in any direction can be interrupted at any time by changing the input signal. If motion is interrupted, the switch-on or switch-off times are proportionally decreased depending on the instantaneous push-pin position.

Only positive signals activate the actuator. In other words, negative signals at ports A and B have no effect on the actuator, which is similar to the behavior of electromagnetically controlled 3-position directional valves.

Basic Assumptions and Limitations

Push-pin loading, such as inertia, spring, hydraulic forces, and so on, is not taken into account.

Parameters

Push-pin stroke

The push-pin stroke. The default value is 0.01 m.

Switching-on time

Time necessary to fully extend the push-pin after the control signal is applied. The default value is 0.1 s.

Switching-off time

Time necessary to retract push-pin from fully extended position after the input signal is removed. The default value is 0.1 s.

Nominal signal value

Sets the value of the nominal input signal. The output motion is initiated as the input signal crosses 50% value of the nominal signal. Other than that, the input signal has no effect on the motion profile. This parameter is meant to reproduce the rated voltage feature of an electromagnet. The default value is 24.

Initial position

Specifies the initial position of the push-pin. The parameter can have one of three values: `Extended positive`, `Extended negative`, or `Neutral`. The default value is `Neutral`.

In selecting the initial position, consider the following:

- The steady-state push-pin position always corresponds to the control signal. In other words, zero signal keeps the push-pin at `Neutral`, positive signal — at `Extended positive`, and negative signal — at `Extended negative`.

- At the start of simulation, if there is a discrepancy between the initial position of the push-pin, as specified by the **Initial position** parameter, and the control signal, the push-pin immediately starts moving towards the steady-state position designated by the control signal.

Restricted Parameters

When your model is in Restricted editing mode, you cannot modify the following parameter:

- **Initial position**

All other block parameters are available for modification.

Ports

The block has the following ports:

A

Physical signal input port associated with the port A input signal.

B

Physical signal input port associated with the port B input signal.

The block also has one physical signal output port, which is associated with the output signal (push-pin displacement).

Examples

In the “3-Position Valve Actuator” example, all three actuators are set to different strokes, switch-on and switch-off times, and initial positions. If the initial position is not **Neutral** and the control signal at the beginning of simulation equals zero, the push-pin starts moving towards neutral position, as the actuators A and C show in the example.

Extended Capabilities

C/C++ Code Generation

Generate C and C++ code using Simulink® Coder™.

See Also

2-Position Valve Actuator | Hydraulic Double-Acting Valve Actuator | Hydraulic Single-Acting Valve Actuator | Proportional and Servo-Valve Actuator

Introduced in R2006a

3-Way Directional Valve

Three-port two-position directional control valve

Library: Simscape / Fluids / Hydraulics (Isothermal) / Valves / Directional Valves

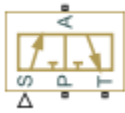

Description

The 3-Way Directional Valve block represents a directional control valve with three ports and two positions, or flow paths. The ports connect to what in a typical model are a hydraulic pump (port **P**), a storage tank (port **T**), and a single-acting actuator (port **A**). Fluid can flow from the pump to the actuator via path **P-A** and from the actuator to the tank via path **A-T**.

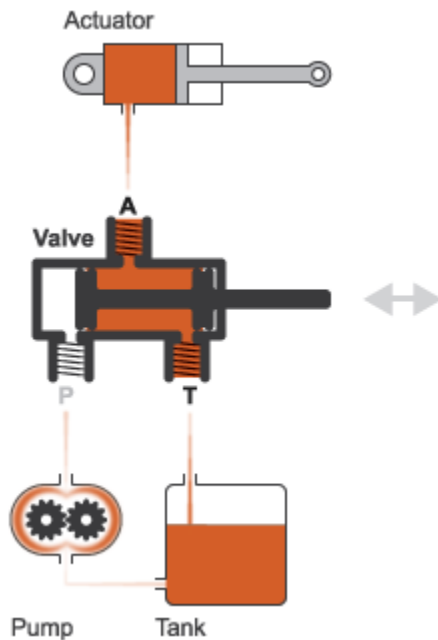

Typical Valve Setup

In the default configuration, one valve position corresponds to the **A-T** flow path maximally open and the **P-A** flow path maximally closed (position **I** in the figure). The second valve position corresponds to the **P-A** flow path maximally open and the **A-T** flow path maximally closed (position **II** in the figure). A translating spool serves as the valve control member and determines the position that the valve is in—**I**, **II**, or in between.

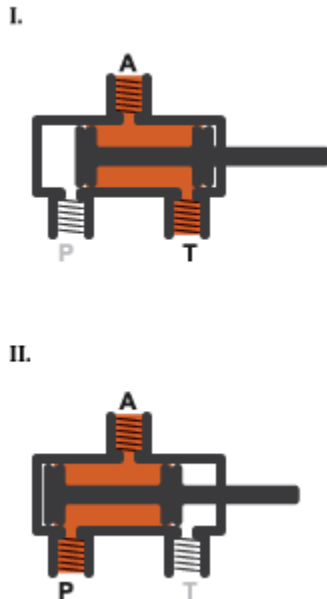

Valve Positions

Physical signal port **S** controls the spool displacement. In the default configuration, a zero displacement corresponds to a fully closed valve between positions **I** and **II**. A negative displacement shifts the spool toward valve position **I**. A positive displacement signal shifts the spool toward valve position **II**. The spool displacement acts indirectly by setting the spool position relative to each flow path—a length known here as the *orifice opening*. The orifice opening in turn determines the opening area of the respective flow path.

Orifice Openings and Offsets

The orifice opening of a flow path depends partly on its *opening offset*—the orifice opening of a flow path at zero spool displacement. The block models only the dynamic effects of the opening offsets. An offset can be due to a change in distance between ports or spool lands—the thick disks built into the spool to obstruct flow. It can also be due to a change in the thicknesses of the spool lands. The orifice openings are computed separately for each flow path in terms of the respective opening offset:

$$h_{PA} = h_{PA0} + \chi,$$

$$h_{AT} = h_{AT0} - \chi,$$

where:

- h_{PA} and h_{AT} are the orifice openings of the **P-A** and **A-T** flow paths. The orifice openings are computed during simulation.
- h_{PA0} and h_{AT0} are the opening offsets of the **P-A** and **A-T** flow paths. The opening offsets are specified in the **Valve opening offsets** tab.
- χ is the spool displacement relative to what in the zero-offset case is a fully closed valve. The spool displacement is specified through physical signal port **S**.

The figure shows the effects of the opening offsets on the orifice openings. Plot **I** corresponds to the default configuration with both opening offsets equal to zero. Plot **II** corresponds to a valve with both

opening offsets greater than zero and plot **III** to a valve with both opening offsets smaller than zero. These cases are similar in behavior to zero-lapped (**I**), underlapped (**II**) and overlapped (**III**) valves. The valve schematics to the right show what the offsets might look like for the **A-T** flow path.

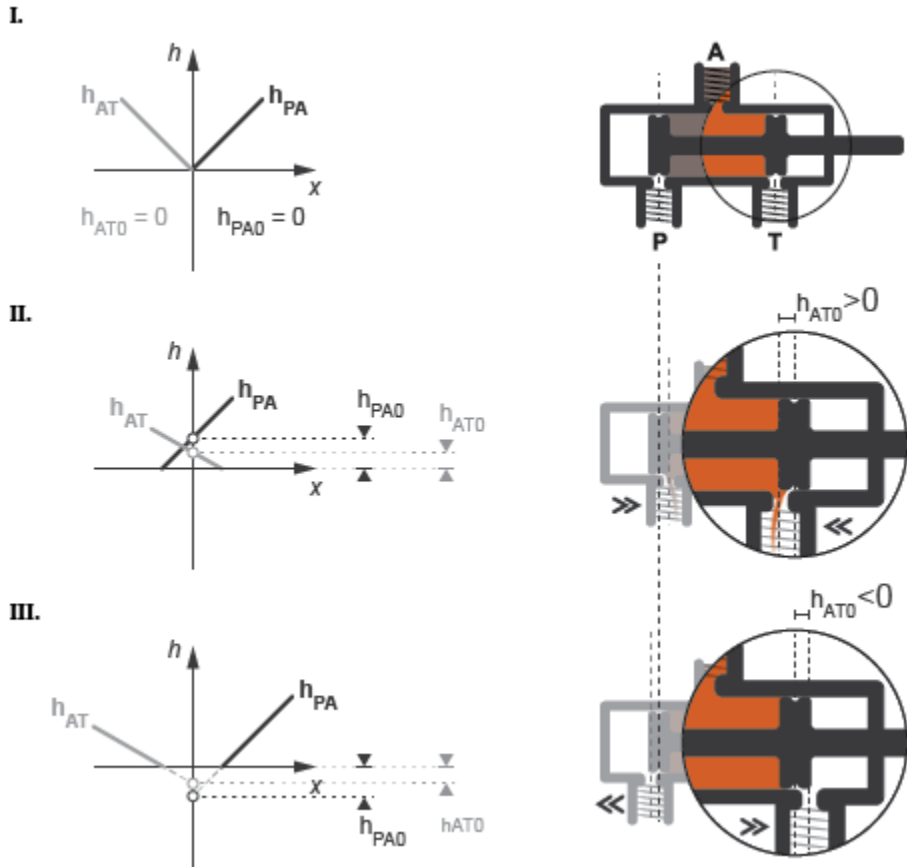

Zero (I), Positive (II), and Negative (III) Opening Offsets

An underlapped valve is always partially open and allows some flow at all spool displacements. An overlapped valve is fully closed over an extended range of spool displacements and requires longer spool travel to open. The table summarizes the opening offsets for zero-lapped, underlapped, and overlapped valves. Other configurations are possible—e.g., with one opening offset positive and the other negative.

Valve Lapping	Opening Offsets
Zero-lapped (default)	Both zero
Underlapped	Both positive
Overlapped	Both negative

Opening Area Parameterizations

The **Model parameterization** setting determines the calculations used for the opening areas of the flow paths—or, in the Pressure-flow characteristic case, the volumetric flow rates. The calculations are based on orifice parameters or tabulated data sets specified in the **Model**

Parameterization tab. The block uses the same data for both flow paths if the **Area characteristics** parameter in the **Basic Parameters** tab is set to **Identical** for all flow paths and different data otherwise. Model parameterizations that you can select include:

- **Maximum area and opening** — Specify the maximum opening area and the corresponding orifice opening. The opening area is a linear function of the orifice opening,

$$A_{AT} = \frac{A_{AT,Max}}{h_{AT,Max}} h_{AT} + A_{Leak},$$

where A is the opening area and h the orifice opening of a given flow path. The subscript **Max** refers to a fully open orifice and the subscript **Leak** to a fully closed orifice—one with internal leakage flow area only. The figure shows a plot of the linear function $A(h)$.

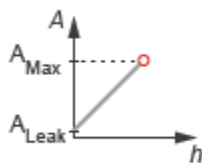

- **Area vs. opening table** — Specify the opening area at discrete orifice openings as a 1-D lookup table. The opening area is computed for a given orifice opening by interpolation or extrapolation of the tabulated data. The figure shows a conceptual plot of the tabulated function $A(h)$.

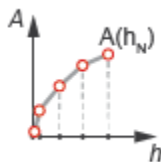

- **Pressure-flow characteristic** — Specify the volumetric flow rate at discrete orifice openings and pressure differentials as a 2-D lookup table. The opening area is computed for a given orifice opening and pressure differential by interpolation or extrapolation of the tabulated data. The figure shows a conceptual plot of the tabulated function $q(h, p)$.

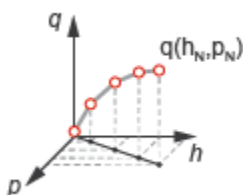

Flow Regime and Internal Leakage

Volumetric flow rates are computed analytically in the **Maximum area and opening** and **Area vs. opening table** parameterizations. The calculations are based on additional block parameters such as the flow discharge coefficient and account for the effects of flow regime—laminar or turbulent. Regime transition occurs at the specified critical laminar flow ratio or critical Reynolds number.

The Maximum area and opening and Area vs. opening table parameterizations also account for a small leakage area associated with the valve spool-to-bore clearance. The leakage area ensures that portions of the hydraulic network never become isolated when a flow path is closed. Isolated, or “hanging”, network portions affect computational efficiency and can cause simulation to fail.

The effects of flow regime and internal leakage are assumed to be reflected in the tabulated flow rate data specified directly in the Pressure-flow characteristic parameterization.

Structural Component Diagram

The block is a composite component with two Variable Orifice blocks driven by a single physical signal. Block Variable Orifice P_A represents the **P-A** flow path. Block Variable orifice A_T represents the **A-T** flow path. The physical signal is specified through Connection Port block **S**.

The **Orifice orientation** block parameters are set so that a positive signal acts to open Variable Orifice P_A while closing Variable Orifice A_T. A negative signal has the opposite effect, acting to open Variable Orifice A_T while closing Variable Orifice P_A.

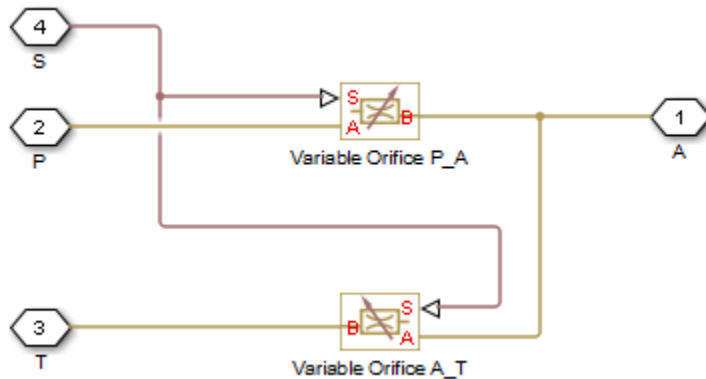

Valve Structural Diagram

Assumptions

- Fluid inertia is ignored.
- Spool loading due to inertial, spring, and other forces is ignored.
- All valve orifices are assumed identical in size unless otherwise specified.

Ports

Input

S — Spool displacement, m

physical signal

Physical signal input port for the spool displacement.

Conserving

P — Supply line orifice

hydraulic (isothermal liquid)

Hydraulic (isothermal liquid) port associated with the supply line orifice.

T – Return line orifice

hydraulic (isothermal liquid)

Hydraulic (isothermal liquid) port associated with the return line orifice.

A – Actuation line orifice

hydraulic (isothermal liquid)

Hydraulic (isothermal liquid) port associated with the actuation orifice.

Parameters

Basic Parameters

Area characteristics – Symmetry of the flow path opening characteristics

Identical for all flow paths (default) | Different for each flow path

Choice of different or identical flow path opening characteristics. Select **Different** for each flow path to specify flow path parameters or tabulated data separately for each flow path.

Model parameterization – Types of valve parameters to use as input

Maximum area and opening (default) | Area vs. opening table | Pressure-flow characteristic

Parameterization of the valve model. Options include:

- **By maximum area and opening** — Specify the maximum orifice opening and opening area. The opening area varies linearly with the spool displacement specified at physical signal port **S**.
- **By area vs. opening table** — Specify the flow path opening area at discrete orifice openings as a 1-D lookup table. The opening area is computed by interpolation or extrapolation of the tabulated data.
- **By pressure-flow characteristic** — Specify the flow path volumetric flow rates at discrete orifice openings and pressure differentials. The flow rate is computed by interpolation or extrapolation of the tabulated data.

Interpolation method – Method of computing values inside the lookup table range

Linear (default) | Smooth

Method of computing values inside the tabulated data range. The **Linear** method joins adjacent data points with straight line or surface segments with generally discontinuous slope at the segment boundaries. Surface segments are used in the 2-D lookup table specified in the **Pressure-flow characteristic** model parameterization.

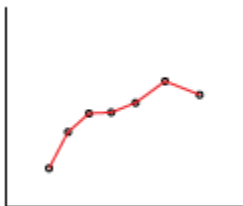

The **Smooth** method replaces the straight segments with curved versions that have continuous slope everywhere inside the tabulated data range. The segments form a smooth line or surface passing through all of the tabulated data points without the discontinuities in first-order derivatives characteristic of the **Linear** interpolation method.

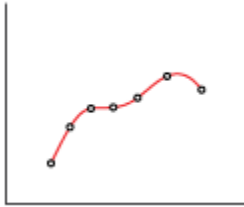

Dependencies

This parameter is active when the **Model Parameterization** parameter is set to **By area vs. opening table** or **Pressure-flow characteristic**.

Extrapolation method — Method of computing values outside of the lookup table range

Linear (default) | Nearest

Method of computing values outside of the tabulated data range. The **Linear** method extends the line segment drawn between the last two data points at each end of the data range outward with a constant slope.

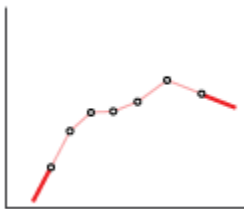

The **Nearest** method extends the last data point at each end of the data range outward as a horizontal line with constant value.

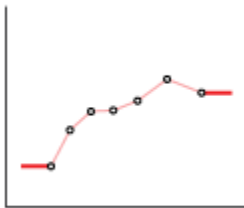

Dependencies

This parameter is active when the **Model Parameterization** parameter is set to **By area vs. opening table** or **Pressure-flow characteristic**.

Flow discharge coefficient — Semi-empirical parameter for valve capacity characterization

0.7 (default) | unitless scalar between 0 and 1

Ratio of the actual and theoretical flow rates through the valve. This parameter depends on the geometrical properties of the valve. Values are usually provided in textbooks and manufacturer data sheets.

Dependencies

This parameter is active when the **Model Parameterization** parameter is set to `By maximum area and opening` or `By area vs. opening table`.

Leakage area — Internal leakage area between valve inlets

`1e-12 m^2` (default) | positive scalar in units of area

Total area of internal leaks in the completely closed state. The purpose of this parameter is to maintain the numerical integrity of the fluid network by preventing a portion of that network from becoming isolated when the valve is completely closed.

Dependencies

This parameter is active when the **Model Parameterization** parameter is set to `By maximum area and opening` or `By area vs. opening table`.

Laminar transition specification — Choice of parameter used to define the laminar-turbulent transition

`Pressure ratio` (default) | `Reynolds number`

Select the parameter to base the laminar-turbulent transition on. Options include:

- `Pressure ratio` — Flow transitions between laminar and turbulent at the pressure ratio specified in the **Laminar flow pressure ratio** parameter. Use this option for the smoothest and most numerically robust flow transitions.
- `Reynolds number` — The transition occurs at the Reynolds number specified in the **Critical Reynolds number** parameter. Flow transitions are more abrupt and can cause simulation issues at near-zero flow rates.

Dependencies

This parameter is active when the **Model Parameterization** parameter is set to `By maximum area and opening` or `By area vs. opening table`.

Laminar flow pressure ratio — Pressure ratio at the laminar-turbulent flow transition

`0.999` (default) | unitless scalar between 0 and 1

Pressure ratio at which the flow transitions between the laminar and turbulent regimes. The pressure ratio is the fraction of the outlet pressure over the inlet pressure.

Dependencies

This parameter is active when the **Model Parameterization** parameter is set to `By maximum area and opening` or `By area vs. opening table` and the **Laminar transition specification** parameter is set to `Pressure ratio`.

Critical Reynolds number — Reynolds number at the laminar-turbulent flow transition

`12` (default) | unitless positive scalar

Maximum Reynolds number for laminar flow. This parameter depends on the orifice geometrical profile. You can find recommendations on the parameter value in hydraulics textbooks. The default value, 12, corresponds to a round orifice in thin material with sharp edges.

Dependencies

This parameter is active when the **Model Parameterization** parameter is set to By maximum area and opening or By area vs. opening table and the **Laminar transition specification** parameter is set to Reynolds number.

Model Parameterization: Maximum area and opening

Maximum opening — Orifice opening at which the opening area is a maximum

0.005 m (default) | positive scalar with units of length

Orifice opening at which the opening area of a flow path is a maximum. The maximum opening is the same for all flow paths when this parameter is exposed. For the orifice opening definitions, see “Orifice Openings and Offsets” on page 1-43.

Dependencies

This parameter is active when the **Area characteristics** parameter is set to Identical for all flow paths and the **Model parameterization** parameter is set to Maximum area and opening.

Maximum opening area — Maximum cross-sectional area of a flow path

0.5e-4 m² (default) | positive scalar with units of area

Maximum cross-sectional area of a flow path. The maximum opening areas are the same for all paths when this parameter is exposed. For the opening area calculations, see “Opening Area Parameterizations” on page 1-44.

Dependencies

This parameter is active when the **Area characteristics** parameter is set to Identical for all flow paths and the **Model parameterization** parameter is set to Maximum area and opening.

P-A, maximum opening — P-A orifice opening at which the opening area is a maximum

0.005 m (default) | positive scalar with units of length

Spool position relative to the **P-A** flow path at which the **P-A** opening area is equal to the **P-A, maximum opening area** parameter.

Dependencies

This parameter is active when the **Area characteristics** parameter is set to Different for each flow path and the **Model parameterization** parameter is set to Maximum area and opening.

P-A, maximum opening area — Maximum flow area of the P-A flow path

0.5e-4 m² (default) | positive scalar with units of area

Maximum cross-sectional area of the **P-A** flow path. The maximum opening areas are different for each flow path when this parameter is exposed. For the opening area calculations, see “Opening Area Parameterizations” on page 1-44.

Dependencies

This parameter is active when the **Area characteristics** parameter is set to Different for each flow path and the **Model parameterization** parameter is set to Maximum area and opening.

A-T, maximum opening — A-T Orifice opening at which the opening area is a maximum

0.005 m (default) | positive scalar with units of length

Spool position relative to the **A-T** flow path at which the **A-T** opening area is equal to the **A-T, maximum opening area** parameter.

Dependencies

This parameter is active when the **Area characteristics** parameter is set to Different for each flow path and the **Model parameterization** parameter is set to Maximum area and opening.

A-T, maximum opening area — Maximum flow area of the A-T flow path0.5e-4 m² (default) | positive scalar with units of area

Maximum cross-sectional area of the **P-A** flow path. The maximum opening areas are different for each flow path when this parameter is exposed. For the opening area calculations, see “Opening Area Parameterizations” on page 1-44.

Dependencies

This parameter is active when the **Area characteristics** parameter is set to Different for each flow path and the **Model parameterization** parameter is set to Maximum area and opening.

Model Parameterization: Area vs. opening table**Opening vector — Orifice openings at which to specify the flow path opening areas**

[-0.002, 0.0, 0.002, 0.005, 0.015] m (default) | numerical array with units of length

Array of orifice openings used to construct the opening area 1-D lookup table for all flow paths. The opening characteristics are identical for all flow paths when this parameter is exposed. The number of elements in the array determines the number of columns in the table.

The array must increase from left to right but the intervals between the array element values need not be uniform. There must be at least two elements for Linear interpolation and three elements for Smooth interpolation.

Dependencies

This parameter is active when the **Area characteristics** parameter is set to Identical for all flow paths and the **Model parameterization** parameter is set to Area vs. opening table.

Opening area vector — Opening areas corresponding to the orifice openings specified in the Opening vector parameter[1.0e-9, 2.0352e-7, 4.0736e-5, 0.00011438, 0.00034356] m² (default) | numerical array with units of area

Array of flow path opening areas corresponding to the specified orifice openings. The number of elements in the array must match the number of elements in the **Opening vector** parameter.

Dependencies

This parameter is active when the **Area characteristics** parameter is set to Identical for all flow paths and the **Model parameterization** parameter is set to Area vs. opening table.

P-A, opening vector — P-A orifice openings at which to specify the P-A opening area

[-0.002, 0.0, 0.002, 0.005, 0.015] m (default) | numerical array with units of length

Array of **P-A** orifice openings used to construct the opening area 1-D lookup table for the **P-A** flow path. The number of elements in the array determines the number of elements in the table.

The array must increase from left to right but the intervals between the array element values need not be uniform. There must be at least two elements for **Linear** interpolation and three elements for **Smooth** interpolation.

Dependencies

This parameter is active when the **Area characteristics** parameter is set to **Different** for each flow path and the **Model parameterization** parameter is set to **Area vs. opening table**.

P-A, opening area vector — P-A opening areas corresponding to the orifice openings specified in the P-A, opening vector parameter

[1.0e-9, 2.0352e-7, 4.0736e-5, 0.00011438, 0.00034356] m² (default) | numerical array with units of area

Array of **P-A** opening areas corresponding to the specified **P-A** orifice openings. The number of elements in the array must match the number of elements in the **P-A, opening vector** parameter.

Dependencies

This parameter is active when the **Area characteristics** parameter is set to **Different** for each flow path and the **Model parameterization** parameter is set to **Area vs. opening table**.

A-T, opening vector — A-T orifice openings at which to specify the A-T opening area

[-0.002, 0.0, 0.002, 0.005, 0.015] m (default) | numerical array with units of length

Array of **A-T** orifice openings used to construct the opening area 1-D lookup table for the **A-T** flow path. The number of elements in the array determines the number of elements in the table.

Dependencies

This parameter is active when the **Area characteristics** parameter is set to **Different** for each flow path and the **Model parameterization** parameter is set to **Area vs. opening table**.

A-T, opening area vector — A-T opening areas corresponding to the orifice openings specified in the A-T, opening vector parameter

[1.0e-9, 2.0352e-7, 4.0736e-5, 0.00011438, 0.00034356] m² (default) | numerical array with units of area

Array of **A-T** opening areas corresponding to the specified **A-T** orifice openings. The number of elements in the array must match the number of elements in the **A-T, opening vector** parameter.

Dependencies

This parameter is active when the **Area characteristics** parameter is set to **Different** for each flow path and the **Model parameterization** parameter is set to **Area vs. opening table**.

Model Parameterization: Pressure-flow characteristic

Opening vector, s — Orifice openings at which to specify the flow rate tabulated data

[-0.002, 0.0, 0.002, 0.005, 0.015] m (default) | numerical array with units of length

Array of orifice openings used to construct the volumetric flow rate 2-D lookup table. The number of elements in the array determines the number of rows in the table. The array must increase from left

to right but the intervals between the array element values need not be uniform. There must be at least two elements for Linear interpolation and three elements for Smooth interpolation.

Dependencies

This parameter is active when the **Area characteristics** parameter is set to Identical for all flow paths and the **Model parameterization** parameter is set to Pressure-flow characteristic.

Pressure differential vector, **dp** – Pressure differentials at which to specify the flow rate data

[-10000000.0, -5000000.0, -2000000.0, 2000000.0, 5000000.0, 10000000.0] Pa (default) | numerical array with units of pressure

Array of pressure differentials used to construct the volumetric flow rate 2-D lookup table. The number of elements in the array determines the number of columns in the table. The array must increase from left to right but the intervals between the array element values need not be uniform. There must be at least two elements for Linear interpolation and three elements for Smooth interpolation.

Dependencies

This parameter is active when the **Area characteristics** parameter is set to Identical for all flow paths and the **Model parameterization** parameter is set to Pressure-flow characteristic.

Volumetric flow rate table, **q(s, dp)** – Volumetric flow rates at the specified orifice openings and pressure differentials

5-by-6 matrix with elements between -0.0344 and 0.0344 m³/s (default) | numerical array with units of length

Matrix with the volumetric flow rates corresponding to the specified orifice openings and pressure differentials. The number of rows must match the number of elements in the **Opening vector, s** parameter. The number of columns must match the number of elements in the **Pressure differential vector, dp** parameter.

Dependencies

This parameter is active when the **Area characteristics** parameter is set to Identical for all flow paths and the **Model parameterization** parameter is set to Pressure-flow characteristic.

P-A, opening vector, **s** – Orifice openings at which to specify the P-A flow rate data

[-0.002, 0.0, 0.002, 0.005, 0.015] m (default) | numerical array with units of length

Array of **P-A** orifice openings used to construct the **P-A** volumetric flow rate 2-D lookup table. The number of elements in the array determines the number of rows in the table. The array must increase from left to right but the intervals between the array element values need not be uniform. There must be at least two elements for Linear interpolation and three elements for Smooth interpolation.

Dependencies

This parameter is active when the **Area characteristics** parameter is set to Different for each flow path and the **Model parameterization** parameter is set to Pressure-flow characteristic.

P-A, pressure differential vector, dp — Pressure differentials at which to specify the P-A flow rate data

[-10000000.0, -5000000.0, -2000000.0, 2000000.0, 5000000.0, 10000000.0] Pa (default) | numerical array with units of pressure

Array of pressure differentials used to construct the volumetric flow rate 2-D lookup table for the **P-A** flow path. The number of elements in the array determines the number of columns in the table.

The array must increase from left to right but the intervals between the array element values need not be uniform. There must be at least two elements for **Linear** interpolation and three elements for **Smooth** interpolation.

Dependencies

This parameter is active when the **Area characteristics** parameter is set to **Different** for each flow path and the **Model parameterization** parameter is set to **Pressure-flow** characteristic.

P-A, volumetric flow rate table, q(s,dp) — Volumetric flow rates at the specified P-A orifice openings and pressure differentials

5-by-6 matrix with elements between -0.0344 and 0.0344 m³/s (default) | numerical array with units of length

Matrix with the volumetric flow rates through the **P-A** flow path at the **P-A** orifice openings and pressure differentials. The number of rows must match the number of elements in the **P-A, opening vector, s** parameter. The number of columns must match the number of elements in the **P-A, pressure differential vector, dp** parameter.

Dependencies

This parameter is active when the **Area characteristics** parameter is set to **Different** for each flow path and the **Model parameterization** parameter is set to **Pressure-flow** characteristic.

A-T, opening vector, s — Orifice openings at which to specify the A-T flow rate data

[-0.002, 0.0, 0.002, 0.005, 0.015] m (default) | numerical array with units of length

Array of **A-T** orifice openings used to construct the **A-T** volumetric flow rate 2-D lookup table. The number of elements in the array determines the number of rows in the table.

The array must increase from left to right but the intervals between the array element values need not be uniform. There must be at least two elements for **Linear** interpolation and three elements for **Smooth** interpolation.

Dependencies

This parameter is active when the **Area characteristics** parameter is set to **Different** for each flow path and the **Model parameterization** parameter is set to **Pressure-flow** characteristic.

A-T, pressure differential vector, dp — Pressure differentials at which to specify the A-T flow rate data

[-10000000.0, -5000000.0, -2000000.0, 2000000.0, 5000000.0, 10000000.0] Pa (default) | numerical array with units of pressure

Array of pressure differentials used to construct the volumetric flow rate 2-D lookup table for the **A-T** flow path. The number of elements in the array determines the number of columns in the table.

The array must increase from left to right but the intervals between the array element values need not be uniform. There must be at least two elements for **Linear** interpolation and three elements for **Smooth** interpolation.

Dependencies

This parameter is active when the **Area characteristics** parameter is set to **Different** for each flow path and the **Model parameterization** parameter is set to **Pressure-flow characteristic**.

A-T, volumetric flow rate table, $q(s, dp)$ — Volumetric flow rates at the specified A-T orifice openings and pressure differentials

5-by-6 matrix with elements between -0.0344 and 0.0344 m³/s (default) | numerical array with units of length

Matrix with the volumetric flow rates through the **A-T** flow path at the **A-T** orifice openings and pressure differentials. The number of rows must match the number of elements in the **A-T, opening vector, s** parameter. The number of columns must match the number of elements in the **A-T, pressure differential vector, dp** parameter.

Dependencies

This parameter is active when the **Area characteristics** parameter is set to **Different** for each flow path and the **Model parameterization** parameter is set to **Pressure-flow characteristic**.

Valve Opening Offsets

Between P-A — P-A orifice opening at zero spool displacement

0 m (default) | scalar number with units of length

Orifice opening of the **P-A** flow path at zero spool displacement. Specify a positive offset to model an underlapped valve or a negative offset to model an overlapped valve. The default value of 0 corresponds to a zero-lapped valve.

Between A-T — A-T orifice opening at zero spool displacement

0 m (default) | scalar number with units of length

Orifice opening of the **A-T** flow path at zero spool displacement. Specify a positive offset to model an underlapped valve or a negative offset to model an overlapped valve. The default value of 0 corresponds to a zero-lapped valve.

Extended Capabilities

C/C++ Code Generation

Generate C and C++ code using Simulink® Coder™.

See Also

2-Way Directional Valve | 4-Way Directional Valve

Topics

“Upgrading Simscape Fluids Models Containing Hydraulics (Isothermal) Blocks”

Introduced in R2017a

3-Way Directional Valve (IL)

3-way flow control valve in an isothermal system

Library: Simscape / Fluids / Isothermal Liquid / Valves & Orifices / Directional Control Valves

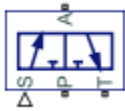

Description

The 3-Way Directional Valve (IL) block models a valve with three openings in an isothermal liquid network, typically between an actuator, pump, and tank. The valve operation is controlled by a single spool displaced according to the signal at port **S**. You can set the baseline configuration of your valve by specifying the orifices that are open when the spool moves in the positive direction and negative directions in the **Positive spool position open connections** and **Negative spool position open connections** parameters, respectively.

You can set the model for valve opening in the **Orifice parameterization** parameter as a linear relationship or function of user-provided data, which can be applied to one or all flow paths in the valve.

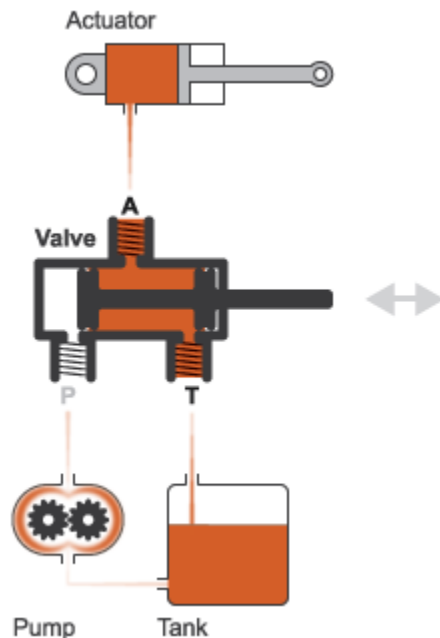

Example Valve Configuration

In this configuration, **Positive spool position open connections** is set to A-T only. When the signal at port **S** moves the spool to a positive position, the path between ports **A** and **T** is open to flow. The paths between ports **P** and **A** and between ports **P** and **T** are closed:

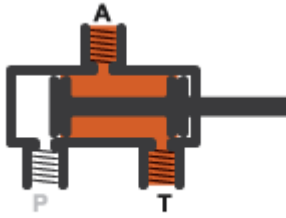

In this configuration, **Negative spool position open connections** is set to P-A only. When the signal at port **S** moves the spool to a negative position, the path between ports **P** and **A** is open to flow and the paths between ports **T** and **A** and between ports **P** and **T** are closed:

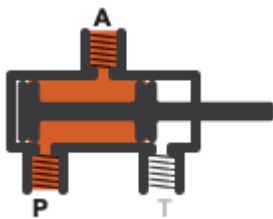

You can open the path between ports **P** and **T** by setting either **Positive spool position open connections** or **Negative spool position open connections** to P-T only or P-A, A-T, and P-T.

A flow path can be open in either the positive or negative spool positions, but not both.

Valve Orifice Parameterizations

The **Orifice parameterization** sets the method for calculating the valve open area. The calculations are based either on the orifice parameters or tabulated data sets specified in the **Model Parameterization** tab. The block uses the same data for all flow paths if **Area characteristics** is set to **Identical for all flow paths**; otherwise, individual values are applied in the **Different for all flow paths** setting. The orifice parameterizations are:

- Linear - area vs. spool travel

The opening area is a linear function of the spool travel distance and the signal received at port **S**:

$$A_{orifice} = \frac{(A_{max} - A_{leak})}{\Delta S_{max}} \Delta S + A_{leak},$$

where:

- A_{max} is the **Maximum orifice area**.
- A_{leak} is the **Leakage area**.
- ΔS_{max} is the **Spool travel between closed and open orifice**.
- ΔS is the spool travel distance. For flow paths that are open in the positive position:

$$\Delta S = S_{orifice_max} + \Delta S_{max} + S,$$

and for flow paths that are open in the negative position:

$$\Delta S = S_{orifice_max} + \Delta S_{max} - S,$$

where $S_{orifice_max}$ is the **Spool position at maximum orifice area**.

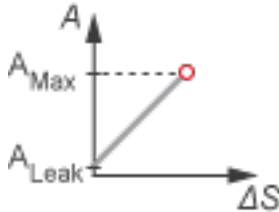

- Tabulated data - Area vs. spool travel

Provide spool travel vectors for your system or for individual flow paths between ports **P** and **A** and ports **A** and **T**. This data will be used to calculate the relationship between the orifice opening area and spool travel distance. Interpolation is used to determine the opening area between given data points. A_{leak} and A_{max} are the first and last parameters of the **Opening area vector**, respectively.

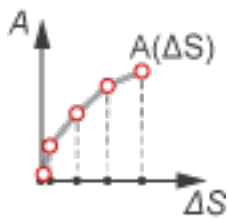

- Tabulated data - Volumetric flow rate vs. spool travel and pressure drop

Provide spool travel and pressure drop vectors. The volumetric flow rate is calculated based on the relationship between pressure change and the spool travel distance. Interpolation is used to determine flow rate between given data points. The mass flow rate is the product of the volumetric flow rate and the local density.

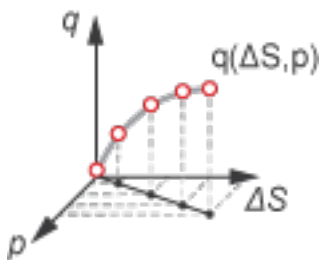

Numerically-Smoothed Valve Area in the Linear Parameterization

When the valve is in a near-open or near-closed position in the linear parameterization, you can maintain numerical robustness in your simulation by adjusting the block **Smoothing factor**. A smoothing function is applied to all calculated areas, but primarily influences the simulation at the extremes of the valve area.

The normalized valve area is calculated as:

$$\hat{A} = \frac{(A_{orifice} - A_{leak})}{(A_{max} - A_{leak})}.$$

The **Smoothing factor**, s , is applied to the normalized area:

$$\widehat{A}_{smoothed} = \frac{1}{2} + \frac{1}{2}\sqrt{\widehat{A}^2 + \left(\frac{s}{4}\right)^2} - \frac{1}{2}\sqrt{(\widehat{A} - 1)^2 + \left(\frac{s}{4}\right)^2}.$$

The smoothed valve area is:

$$A_{smoothed} = \widehat{A}_{smoothed}(A_{max} - A_{leak}) + A_{leak}.$$

Visualize Orifice Openings

To visualize spool offsets and displacement, right-click on the block and select **Fluids > Plot Valve Characteristics**. The plot shows the orifices selected in the **Valve Configuration** tab settings. The axes are set by the orifice parameterization selection and are either:

- Orifice Area vs. Spool Position
- Volumetric Flow Rate vs. Spool Position, queried at a specific pressure differential

Each time you modify the block settings, click **Apply** at the bottom of the dialog box, then click **Reload Data** on the figure window.

The image below shows the valve default configuration. On the **Valve Configuration** tab:

- **Positive spool position open connections** is set to P-A only.
- **Negative spool position open connections** is set to A-T only.

All other spool positions are at the default values.

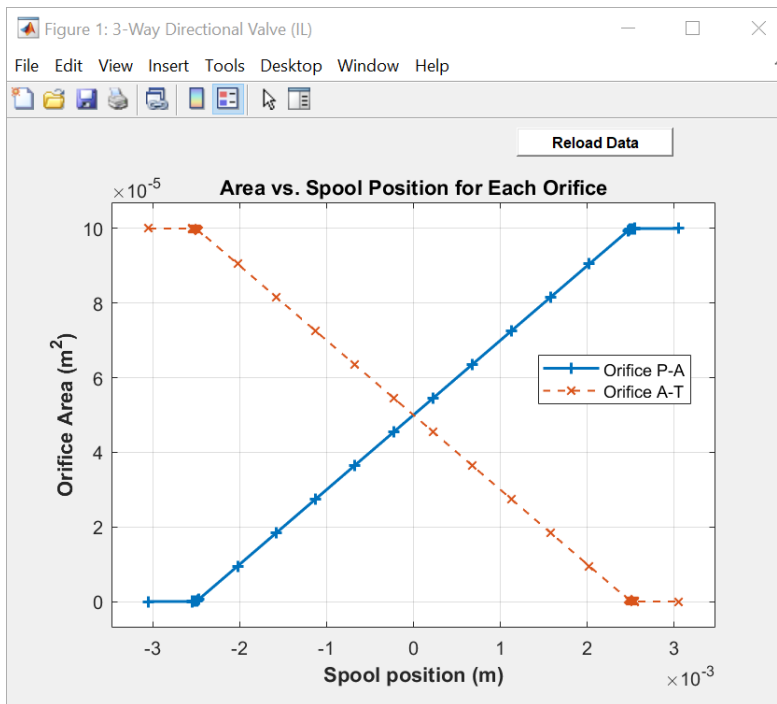

Example Spool Position Visualization

Faulty Behavior

When faults are enabled, the valve open area becomes stuck at a specified spool position in response to one of these triggers:

- Simulation time — Faulting occurs at a specified time.
- Simulation behavior — Faulting occurs in response to an external trigger. This exposes port **Tr**.

Three fault options are available in the **Spool position when faulted** parameter:

- **Positive** — The spool position freezes in the positive position, opening the **Positive spool position open connections** flow paths to their maximum value. The flow paths that are only open in the **Negative spool position open connections** and **Neutral spool position open connections** are closed.
- **Negative** — The spool position freezes in the negative position, opening the **Negative spool position open connections** flow paths to their maximum value. The flow paths that are only open in the **Positive spool position open connections** and **Neutral spool position open connections** are closed.
- **Maintain last value** — The valve freezes at the spool position when the trigger occurs.

Due to numerical smoothing at the extremes of the valve area, in the linear parameterization, the minimum area applied is larger than the **Leakage area**, and the maximum is smaller than the **Maximum orifice area**, in proportion to the **Smoothing factor** value.

Once triggered, the valve remains at the faulted area for the rest of the simulation.

Predefined Parameterization

Pre-parameterization of the 3-Way Directional Valve (IL) block with manufacturer data is available. This data allows you to model a specific supplier component.

To load a predefined parameterization,

- 1 Click the "Select a predefined parameterization" hyperlink in the 3-Way Directional Valve (IL) block dialog description.
- 2 Select a part from the drop-down menu and click **Update block with selected part**.
- 3 If you change any parameter settings after loading a parameterization, you can check your changes by clicking **Compare block settings with selected part**. Any difference in settings between the block and pre-defined parameterization will display in the MATLAB command window.

Note that it is not possible to set different values for the same orifice for both positive and negative displacement of the control member. Additionally, the opening area is mirrored around the neutral position.

Note Predefined parameterizations of Simscape components use available data sources for supplying parameter values. Engineering judgement and simplifying assumptions are used to fill in for missing data. As a result, deviations between simulated and actual physical behavior should be expected. To ensure requisite accuracy, you should validate simulated behavior against experimental data and refine component models as necessary.

Assumptions

- Fluid inertia is ignored.
- Spool loading due to inertial, spring, and other forces is ignored.
- All valve orifices are assumed to be identical in size unless otherwise specified.

Ports

Conserving

A — Liquid port

isothermal liquid

Exit point of the valve.

P — Liquid port

isothermal liquid

Entry point to the valve.

T — Liquid port

isothermal liquid

Entry or exit point to the valve.

Input

S — Control member displacement, m

physical signal

Spool position displacement in m, received as a physical signal. For flow paths that open in the positive spool position, a positive signal opens the orifice. For flow paths that open in the negative spool position, a negative signal opens the orifice.

Tr — External fault trigger

physical signal

Physical signal port for an external fault trigger. Triggering occurs when the value is greater than 0.5. There is no unit associated with the trigger value.

Dependencies

This port is visible when **Enable faults** is set to On and **Fault trigger** is set to External.

Parameters

Model Parameterization

Positive spool position open connections — Flow paths open when the spool is in a positive position

P-T only (default) | All closed | P-A, A-T, and P-T | P-A only | A-T only

Flow paths open when the spool is in a positive position. This parameter sets the valve configuration and defines the direction of spool movement according to the signal received at port **S**.

Negative spool position open connections — Flow paths open when the spool moves in the negative direction

P-A only (default) | All closed | P-A, A-T, and P-T | A-T only | P-T only

Flow paths open when the spool moves in the negative direction. This parameter sets the valve configuration and defines the direction of spool movement according to the signal received at port **S**.

Area characteristics — Flow equations for orifices

Identical for all flow paths (default) | Different for each flow path

Applies uniform or individual flow equations for the valve orifice area. Identical for all flow paths uses the same orifice and spool geometries, flow rates, pressure, and area vectors for all valve orifices. When using Different for each flow path, different spool offsets and tabulated data are assigned to the orifices between ports **P** and **A**, ports **A** and **T**, and ports **P** and **T**. In both cases, ports **A**, **P**, and **T** have the same cross-sectional areas, discharge coefficients, and Reynolds numbers. The same **Orifice parameterization** is also applied to all flow paths.

Orifice parameterization — Method of calculating opening area

Linear area vs. spool travel (default) | Tabulated data - Area vs. spool travel | Tabulated data - volumetric flow rate vs. spool travel and pressure drop

Method of calculating the valve opening area. In the tabulated data parameterizations, you can provide your own valve area and spool travel data for nonlinear valve opening profiles, or you can provide data in terms of volumetric flow rate, spool travel, and pressure drop over the flow path.

Spool travel between closed and open orifice — Maximum spool stroke

0.005 m (default) | positive scalar

Maximum distance of spool travel. This value provides an upper limit to calculations so that simulations do not return unphysical values.

Dependencies

To enable this parameter, set **Area characteristics** to Identical for all flow paths.

Maximum orifice area — Maximum orifice opening area1e-4 m² (default) | positive scalar

Largest open area during operation of valve.

Dependencies

To enable this parameter, set **Area characteristics** to Identical for all flow paths.

Cross-sectional area at ports A, P and T — Area at valve entry or exitinf m² (default) | positive scalar

Cross-sectional area at the entry and exit ports **A**, **P**, and **T**. These areas are used in the pressure-flow rate equation that determines volumetric flow rate through the valve.

Leakage area — Gap area when in fully closed position1e-10 m² (default) | positive scalar

Sum of all gaps when the valve is in its fully closed position. Any area smaller than this value is maintained at the specified leakage area. This contributes to numerical stability by maintaining continuity in the flow.

Dependencies

To enable this parameter, set **Area characteristics** to Identical for all flow paths and **Orifice parameterization** to Linear - area vs. spool travel.

Discharge coefficient — Discharge coefficient

0.64 (default) | positive scalar

Correction factor that accounts for discharge losses in theoretical flows.

Critical Reynolds number — Upper Reynolds number limit for laminar flow

150 (default) | positive scalar

Upper Reynolds number limit for laminar flow through the valve.

Smoothing factor — Numerical smoothing factor

0.01 (default) | positive scalar in the range [0,1]

Continuous smoothing factor that introduces a layer of gradual change based to the flow response when the valve is in near-open and near-closed positions. To increase the stability of your simulation in these regimes, set this parameter to a nonzero value less than one.

Pressure recovery — Whether to account for pressure increase in area expansions

On (default) | Off

Select to account for pressure increase when fluid flows from a region of a smaller cross-sectional area to a region of larger cross-sectional area.

Spool travel vector — Vector of valve opening distance

[0, .002, .004, .007, .017] m (default) | 1-by-n vector

Vector of control member travel distances for the tabular parameterization of valve area. The vector elements must correspond one-to-one with the elements in the **Orifice area vector** parameter. The values are listed in ascending order and the first element must be 0. Linear interpolation is employed between table data points.

Dependencies

To enable this parameter, set **Area characteristics** to Identical for all flow paths and **Orifice parameterization** to Tabulated data - Area vs. spool travel.

Orifice area vector — Vector of valve opening areas

[1e-09, 2.0352e-07, 4.0736e-05, .00011438, .00034356] m² (default) | 1-by-n vector

Vector of opening areas for the tabular parameterization of valve opening area. The vector elements must correspond one-to-one with the elements in the **Spool travel vector** parameter. The elements are listed in ascending order and must be greater than 0.

Dependencies

To enable this parameter, set **Area characteristics** to Identical for all flow paths and **Opening parameterization** to Tabulated data - Area vs. spool travel.

Spool travel vector, ds — Vector of valve opening distances

[0, .002, .004, .007, .017] m (default) | 1-by-n vector

Vector of control member travel distances for tabular parametrization of volumetric flow rate. The spool travel vector forms an independent axis with the **Pressure drop vector, dp** parameter for the 3-D dependent **Volumetric flow rate table, $q(ds,dp)$** parameter. A positive displacement corresponds to valve opening. The values are listed in ascending order and the first element must be 0. Linear interpolation is employed between table data points.

Dependencies

To enable this parameter, set **Area characteristics** to Identical for all flow paths and **Orifice parameterization** to Volumetric flow rate vs. spool travel and pressure drop.

Pressure drop vector, dp — Vector of valve pressure drop values

[.3, .5, .7] MPa (default) | 1-by- n vector

Vector of pressure drop values for tabular parametrization of volumetric flow rate. The pressure drop vector forms an independent axis with the **Spool travel vector, s** parameter for the 3-D dependent **Volumetric flow rate table, $q(ds,dp)$** parameter. The values are listed in ascending order and must be greater than 0. Linear interpolation is employed between table data points.

Dependencies

To enable this parameter, set **Area characteristics** to Identical for all flow paths and **Orifice parameterization** to Volumetric flow rate vs. spool travel and pressure drop.

Volumetric flow rate table, $q(ds,dp)$ — Array of volumetric flow rates

[1.7e-05, 2e-05, 2.6e-05; .0035, .0045, .0053; .7, .9, 1.06; 1.96, 2.5, 3; 6, 7.7, 9.13] .* 1e-3 m³/s (default) | M -by- N matrix

M -by- N matrix of volumetric flow rates based on independent values of pressure drop and spool travel distance. M and N are the sizes of the corresponding vectors:

- M is the number of elements in the **Pressure drop vector, dp** parameter.
- N is the number of elements in the **Spool travel vector, ds** parameter.

Dependencies

To enable this parameter, set **Area characteristics** to Identical for all flow paths and **Orifice parameterization** to Tabulated data - Volumetric flow rate vs. spool travel and pressure drop.

P-A Orifice

Spool position at maximum P-A orifice area — Spool offset at maximum area between ports P and A

2.5e-3 m (default) | scalar

Initial orifice opening distance between ports **P** and **A**. The default represents a zero-lapped system. A positive, nonzero value represents an underlapped, or partially open, system. A negative, nonzero value represents an overlapped system, where the valve remains closed over a range of control member displacements.

P-A spool travel between closed and open orifice — Maximum stroke for the spool between ports P and A

0.005 m (default) | positive scalar

Maximum distance of spool travel for the orifice between ports **P** and **A**. This value provides an upper limit to calculations so that simulations do not return unphysical values.

Dependencies

To enable this parameter, set **Area characteristics** to Different for each flow path.

P-A maximum orifice area – Maximum area between ports P and A

$1e-4 \text{ m}^2$ (default) | positive scalar

Cross-sectional area of the orifice between ports **P** and **A** in its fully open position.

Dependencies

To enable this parameter, set **Area characteristics** to Different for each flow path and **Orifice parameterization** to Linear - area vs. spool travel.

P-A orifice spool travel vector – Vector of valve opening distance

[0, .002, .004, .007, .017] m (default) | 1-by-n vector

Vector of control member travel distances for the tabular parameterization of valve area. The vector elements must correspond one-to-one with the elements in the **P-A orifice area vector** parameter. The values are listed in ascending order and the first element must be 0. Linear interpolation is employed between table data points.

Dependencies

To enable this parameter, set **Area characteristics** to Different for each flow path and **Orifice parameterization** to Tabulated data - Area vs. spool travel.

P-A orifice area vector – Vector of valve opening areas

[$1e-09$, $2.0352e-07$, $4.0736e-05$, .00011438, .00034356] m^2 (default) | 1-by-n vector

Vector of opening areas for the tabular parameterization of valve opening area. The vector elements must correspond one-to-one with the elements in the **P-A orifice spool travel vector** parameter. The elements are listed in ascending order and must be greater than 0.

Dependencies

To enable this parameter, set **Area characteristics** to Different for each flow path and **Opening parameterization** to Tabulated data - Area vs. spool travel.

P-A orifice spool travel vector, ds – Vector of valve opening distances

[0, .002, .004, .007, .017] m (default) | 1-by-n vector

Vector of control member travel distances for tabular parametrization of volumetric flow rate. The spool travel vector forms an independent axis with the **P-A orifice pressure drop vector, dp** parameter for the 3-D dependent **P-A orifice volumetric flow rate table, q(s,dp)** parameter. A positive displacement corresponds to valve opening. The values are listed in ascending order and the first element must be 0. Linear interpolation is employed between table data points.

Dependencies

To enable this parameter, set **Area characteristics** to Different for each flow path and **Orifice parameterization** to Tabulated data - Volumetric flow rate vs. spool travel and pressure drop.

P-A orifice pressure drop vector, dp — Vector of pressure drop values over the valve
 [.3, .5, .7] MPa (default) | 1-by- n vector

Vector of pressure drop values for tabular parametrization of volumetric flow rate. The pressure drop vector forms an independent axis with the **P-A orifice spool travel vector, s** parameter for the 3-D dependent **P-A orifice volumetric flow rate table, $q(s,dp)$** parameter. The values are listed in ascending order and must be greater than 0. Linear interpolation is employed between table data points.

Dependencies

To enable this parameter, set **Area characteristics** to Different for each flow path and **Orifice parameterization** to Tabulated data - Volumetric flow rate vs. spool travel and pressure drop.

P-A orifice volumetric flow rate table, $q(ds,dp)$ — Vector of valve volumetric flow rates

[1.7e-05, 2e-05, 2.6e-05; .0035, .0045, .0053; .7, .9, 1.06; 1.96, 2.5, 3; 6, 7.7, 9.13] .* 1e-3 m³/s (default) | M -by- N matrix

M -by- N matrix of volumetric flow rates based on independent values of pressure drop and spool travel distance. M and N are the sizes of the corresponding vectors:

- M is the number of elements in the **P-A orifice pressure drop vector, dp** parameter.
- N is the number of elements in the **P-A orifice spool travel vector, s** parameter.

Dependencies

To enable this parameter, set **Area characteristics** to Different for each flow path and **Orifice parameterization** to Tabulated data - Volumetric flow rate vs. spool travel and pressure drop.

A-T Orifice

Spool position at maximum A-T orifice area — Spool offset at maximum area between ports A and T

5e-3 m (default) | scalar

Initial orifice opening distance between ports **A** and **T**. The default represents a zero-lapped system. A positive, nonzero value represents an underlapped, or partially-open, system. A negative, nonzero value represents an overlapped system, where the valve remains closed over a range of control member displacements.

A-T spool travel between closed and open orifice — Maximum stroke for the spool between ports A and T

0.005 m (default) | positive scalar

Maximum distance of spool travel for the orifice between ports **A** and **T**. This value provides an upper limit to calculations so that simulations do not return unphysical values.

Dependencies

To enable this parameter, set **Area characteristics** type to Different for each flow path.

A-T maximum orifice area — Maximum area between ports A and T

1e-4 m² (default) | positive scalar

Cross-sectional area of the orifice between ports **A** and **T** in its fully open position.

Dependencies

To enable this parameter, set **Area characteristics** to Different for each flow path and **Orifice parameterization** to Linear - area vs. spool travel.

A-T orifice spool travel vector – Vector of valve opening distances

[0, .002, .004, .007, .017] m (default) | 1-by-*n* vector

Vector of control member travel distances for the tabular parameterization of valve area. The vector elements must correspond one-to-one with the elements in the **A-T orifice area vector** parameter. The values are listed in ascending order and the first element must be 0. Linear interpolation is employed between table data points.

Dependencies

To enable this parameter, set **Area characteristics** to Different for each flow path and **Orifice parameterization** to Tabulated data - Area vs. spool travel.

A-T orifice area vector – Vector of valve opening areas

[1e-09, 2.0352e-07, 4.0736e-05, .00011438, .00034356] m² (default) | 1-by-*n* vector

Vector of opening areas for the tabular parameterization of valve opening area. The vector elements must correspond one-to-one with the elements in the **A-T orifice spool travel vector** parameter. The elements are listed in ascending order and must be greater than 0.

Dependencies

To enable this parameter, set **Area characteristics** to Different for each flow path and **Opening parameterization** to Tabulated data - Area vs. spool travel.

A-T orifice spool travel vector, *ds* – Vector of valve opening distances

[0, .002, .004, .007, .017] m (default) | 1-by-*n* vector

Vector of control member travel distances for tabular parametrization of volumetric flow rate. The spool travel vector forms an independent axis with the **A-T orifice pressure drop vector, *dp*** parameter for the 3-D dependent **A-T orifice volumetric flow rate table, *q(ds,dp)*** parameter. A positive displacement corresponds to valve opening. The values are listed in ascending order and the first element must be 0. Linear interpolation is employed between table data points.

Dependencies

To enable this parameter, set **Area characteristics** to Different for each flow path and **Orifice parameterization** to Tabulated data - Volumetric flow rate vs. spool travel and pressure drop.

A-T orifice pressure drop vector, *dp* – Vector of pressure drop values over the valve

[.3, .5, .7] MPa (default) | 1-by-*n* vector

Vector of pressure drop values for tabular parametrization of volumetric flow rate. The pressure drop vector forms an independent axis with the **A-T orifice spool travel vector, *s*** parameter for the 3-D dependent **A-T orifice volumetric flow rate table, *q(ds,dp)*** parameter. The values are listed in ascending order and must be greater than 0. Linear interpolation is employed between table data points.

Dependencies

To enable this parameter, set **Area characteristics** to Different for each flow path and **Orifice parameterization** to Tabulated data - Volumetric flow rate vs. spool travel and pressure drop.

A-T orifice volumetric flow rate table, $q(ds, dp)$ — Vector of volumetric flow rate for tabular parameterization - different flow paths

[1.7e-05, 2e-05, 2.6e-05; .0035, .0045, .0053; .7, .9, 1.06; 1.96, 2.5, 3; 6, 7.7, 9.13] .* 1e-3 m³/s (default) | *M*-by-*N* matrix

M-by-*N* matrix of volumetric flow rates based on independent values of pressure drop and spool travel distance. *M* and *N* are the sizes of the corresponding vectors:

- *M* is the number of elements in the **A-T orifice pressure drop vector, dp** parameter.
- *N* is the number of elements in the **A-T orifice spool travel vector, s** parameter.

Dependencies

To enable this parameter, set **Area characteristics** to Different for each flow path and **Orifice parameterization** to Tabulated data - Volumetric flow rate vs. spool travel and pressure drop.

P-T Orifice**Spool position at maximum P-T orifice area — Spool offset at maximum area between ports P and T**

5e-3 m (default) | scalar

Initial orifice opening distance between ports **P** and **T**. The default represents a zero-lapped system. A positive, nonzero value represents an underlapped, or partially-open, system. A negative, nonzero value represents an overlapped system, where the valve remains closed over a range of control member displacements.

P-T spool travel between closed and open orifice — Maximum stroke for the spool between ports P and T

0.005 m (default) | positive scalar

Maximum distance of spool travel for the orifice between ports **P** and **T**. This value provides an upper limit to calculations so that simulations do not return unphysical values.

Dependencies

To enable this parameter, set **Area characteristics** type to Different for each flow path.

P-T maximum orifice area — Maximum area between ports P and T

1e-4 m² (default) | positive scalar

Cross-sectional area of the orifice between ports **P** and **T** in its fully open position.

Dependencies

To enable this parameter, set **Area characteristics** to Different for each flow path and **Orifice parameterization** to Linear - area vs. spool travel.

P-T orifice spool travel vector – Vector of valve opening distances

[0, .002, .004, .007, .017] m (default) | 1-by-*n* vector

Vector of control member travel distances for the tabular parameterization of valve area. The vector elements must correspond one-to-one with the elements in the **P-T orifice area vector** parameter. The values are listed in ascending order and the first element must be 0. Linear interpolation is employed between table data points.

Dependencies

To enable this parameter, set **Area characteristics** to Different for each flow path and **Orifice parameterization** to Tabulated data - Area vs. spool travel.

P-T orifice area vector – Vector of valve opening areas

[1e-09, 2.0352e-07, 4.0736e-05, .00011438, .00034356] m² (default) | 1-by-*n* vector

Vector of opening areas for the tabular parameterization of valve opening area. The vector elements must correspond one-to-one with the elements in the **P-T orifice spool travel vector** parameter. The elements are listed in ascending order and must be greater than 0.

Dependencies

To enable this parameter, set **Area characteristics** to Different for each flow path and **Opening parameterization** to Tabulated data - Area vs. spool travel.

P-T orifice spool travel vector, ds – Vector of valve opening distances

[0, .002, .004, .007, .017] m (default) | 1-by-*n* vector

Vector of control member travel distances for tabular parametrization of volumetric flow rate. The spool travel vector forms an independent axis with the **P-T orifice pressure drop vector, dp** parameter for the 3-D dependent **P-T orifice volumetric flow rate table, q(ds,dp)** parameter. A positive displacement corresponds to valve opening. The values are listed in ascending order and the first element must be 0. Linear interpolation is employed between table data points.

Dependencies

To enable this parameter, set **Area characteristics** to Different for each flow path and **Orifice parameterization** to Tabulated data - Volumetric flow rate vs. spool travel and pressure drop.

P-T orifice pressure drop vector, dp – Vector of pressure drop values over the valve

[.3, .5, .7] MPa (default) | 1-by-*n* vector

Vector of pressure drop values for tabular parametrization of volumetric flow rate. The pressure drop vector forms an independent axis with the **P-T orifice spool travel vector, ds** parameter for the 3-D dependent **P-T orifice volumetric flow rate table, q(ds,dp)** parameter. The values are listed in ascending order and must be greater than 0. Linear interpolation is employed between table data points.

Dependencies

To enable this parameter, set **Area characteristics** to Different for each flow path and **Orifice parameterization** to Tabulated data - Volumetric flow rate vs. spool travel and pressure drop.

P-T orifice volumetric flow rate table, $q(ds,dp)$ – Vector of volumetric flow rate for tabular parameterization - different flow paths

[1.7e-05, 2e-05, 2.6e-05; .0035, .0045, .0053; .7, .9, 1.06; 1.96, 2.5, 3; 6, 7.7, 9.13] .* 1e-3 m³/s (default) | *M*-by-*N* matrix

M-by-*N* matrix of volumetric flow rates based on independent values of pressure drop and spool travel distance. *M* and *N* are the sizes of the corresponding vectors:

- *M* is the number of elements in the **P-T orifice pressure drop vector, dp** parameter.
- *N* is the number of elements in the **P-T orifice spool travel vector, ds** parameter.

Dependencies

To enable this parameter, set **Area characteristics** to `Different` for each flow path and **Orifice parameterization** to `Tabulated data - Volumetric flow rate vs. spool travel and pressure drop`.

Faults**Enable faults – Fault option**

Off (default) | On

Enable externally or temporally triggered faults. When faulting occurs, the valve area normally set by the opening parameterization will be set to the value specified in the **Spool position when faulted** parameter.

Spool position when faulted – Set faulted characteristics

Positive (default) | Negative | Maintain last value

Sets the faulted valve spool position. You can choose for the valve to seize when the spool is in the positive position, negative position, or at the position when faulting is triggered.

Dependencies

To enable this parameter, set **Enable faults** to On.

Fault trigger – External trigger option

Off (default) | Fault when $Tr \geq 0.5$

Whether a fault trigger occurs due to an external event or at a specified time.

When set to `External`, port **Tr** is enabled. A physical signal at port **Tr** that is greater than 0.5 triggers faulting.

When set to `Temporal`, when the **Simulation time for fault event** is reached, the valve area will be set to the value specified in the **Spool position when faulted** parameter.

Dependencies

To enable this parameter, set **Enable faults** to On.

Simulation time for fault event – Time at which faulting is triggered

5 s (default) | positive scalar

When the **Simulation time for fault event** is reached, the valve area is set to the value specified in the **Spool position when faulted** parameter.

Dependencies

To enable this parameter, set **Enable faults** to On and **Fault trigger** to Temporal.

See Also

4-Way 3-Position Directional Valve (IL) | 2-Way Directional Valve (IL) | Pressure-Compensated 3-Way Flow Control Valve (IL) | Pressure-Reducing 3-Way Valve (IL) | Orifice (IL)

Topics

“Modeling Valves in Simscape Fluids”
“Building a Custom Valve”

Introduced in R2020a

3-Way Directional Valve (G)

Controlled valve with three ports and two flow paths

Library: Simscape / Fluids / Gas / Valves & Orifices / Directional Control Valves

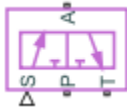

Description

The 3-Way Directional Valve (G) block models a valve with three gas ports (**P**, **A**, and **T**) and two flow paths to switch between (**P-A** and **A-T**). The paths each run through an orifice of variable width, its opening here tied to the motion of a control member. Think of the control member as a spool with two lands to cover (by degrees) the **P-A** and **A-T** orifices. The distance of a land to its appointed orifice determines if, and to what extent, that orifice is open.

(The distances from the lands to the orifices are computed during simulation from the displacement signal specified at port **S**. They, and all distances related to spool position, are defined as unitless fractions, generally valued between -1 and +1. The calculations are described in detail under “Orifice Opening Fractions” on page 1-74.)

The gas ports connect to what, in a representative system, are a pump (**P**), a tank (**T**), and a single-acting actuator (**A**). Opening the **P-A** flow path (while closing **A-T**) allows the pump to pressurize the actuator. The shaft of the latter translates (normally to extend). Opening the alternate (**A-T**) flow path (while closing **P-A**) allows the tank to absorb the excess pressure from the actuator, freeing the shaft to translate in reverse (for example, by the weight of the translated load).

The port connections will vary with the system being modeled, but the purpose of the valve—to switch between flow paths and to regulate the flow passing through them—should not.

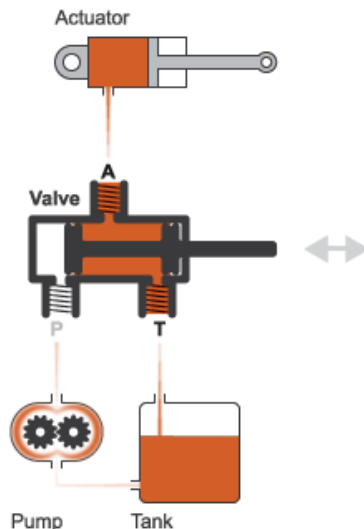

A Common Use of a 3-Way Directional Valve

The flow can be laminar or turbulent, and it can reach (up to) sonic speeds. This happens at the vena contracta, a point just past the throat of the valve where the flow is both its narrowest and fastest. The flow then chokes and its velocity saturates, with a drop in downstream pressure no longer sufficing to increase its velocity. Choking occurs when the back-pressure ratio hits a critical value characteristic of the valve. Supersonic flow is not captured by the block.

Valve Positions

The valve is continuously variable. It shifts smoothly between positions, of which it has three: one normal and two working.

The normal position is that to which the valve reverts when it is no longer being operated. The instantaneous displacement of the spool (given at port **S**) is then zero. Unless the lands of the spool are installed at an offset to their orifices, the valve will be fully closed.

The working positions are those to which the valve moves when the spool is maximally displaced, in either positive or negative direction, from the normal position. One orifice will then generally be closed and the other open to full capacity. If the displacement is in the negative direction, the **P-A** orifice is closed and the **A-T** orifice open (position **I** in the figure). If the displacement is in the positive direction, the **P-A** orifice is open and the **A-T** orifice closed (position **II**).

I.

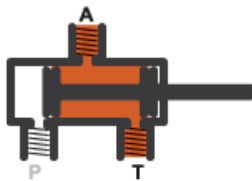

II.

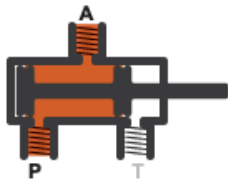

What spool displacement puts the valve in a working position depends on the offsets of the lands on the spool. These are generally applied before operation, in a real valve, and before simulation, in a valve model. They are specified in the block as constants (fixed from the start of simulation) in the **Valve Opening Fraction Offsets** tab.

Orifice Opening Fractions

Between valve positions, the opening of an orifice depends on where, relative to its rim, its land of the spool happens to be. This distance is the orifice opening, and it is normalized here so that its value is a fraction of its maximum (the distance at which the orifice is fully open). The normalized variable is referred to here as the *orifice opening fraction*.

The orifice opening fractions range from -1 in working position **I** to +1 in working position **II** (using the labels shown in the figure).

The opening fractions are calculated from the lengths already alluded to: the variable displacement of the control member (applied during operation) and the fixed offsets of its lands (applied during installation). These lengths are themselves defined as unitless fractions of the maximum land-orifice distance. (The offsets are referred to here as the *opening fraction offsets*.)

The opening fraction of the **P-A** orifice is:

$$h_{\mathbf{PA}} = H_{\mathbf{PA}} + x .$$

That of the **A-T** orifice is:

$$h_{\mathbf{AT}} = H_{\mathbf{AT}} - x .$$

In both equations:

- h is the opening fraction of the orifice denoted by the subscript (**P-A** or **A-T**). If the calculation should return a value outside of the range **0-1**, the nearest limit is used. (The orifice opening fractions are said to *saturate* at **0** and **1**.)
- H is the opening fraction offset for the orifice denoted by the subscript. The offsets are each specified as a block parameter (in the **Valve Opening Fraction Offsets** tab). To allow for unusual valve configurations, no limit is imposed on their values, though generally these will fall between **-1** and **+1**.
- x is the normalized instantaneous displacement of the spool, specified as a physical signal at port **S**. To compensate for equally extreme opening fraction offsets, no limit is imposed on its value (though it generally will fall near the range of **-1** to **+1**.)

Opening Fraction Offsets

The valve is by default configured so that it is fully closed when the spool displacement is zero. Such a valve is often described as being *zero-lapped*.

It is possible, by offsetting the lands of the spool, to model a valve that is underlapped (partially open in the normal valve position) or overlapped (fully closed not only *in* but also slightly *beyond* the normal position). The figure shows, for each case, how the orifice opening fractions vary with the instantaneous spool displacement:

- **Case I:** A zero-lapped valve. The opening fraction offsets are both zero. When the valve is in the normal position, the lands of the spool completely cover both orifices.
- **Case II:** An underlapped valve. The opening fraction offsets are both positive. When the valve is in the normal position, the lands of the spool cover both orifices, but neither fully.
- **Case III:** An overlapped valve. The opening fraction offsets are both negative. The lands of the spool completely cover both orifices not only in the normal position but over a small region (of spool displacements) around it.

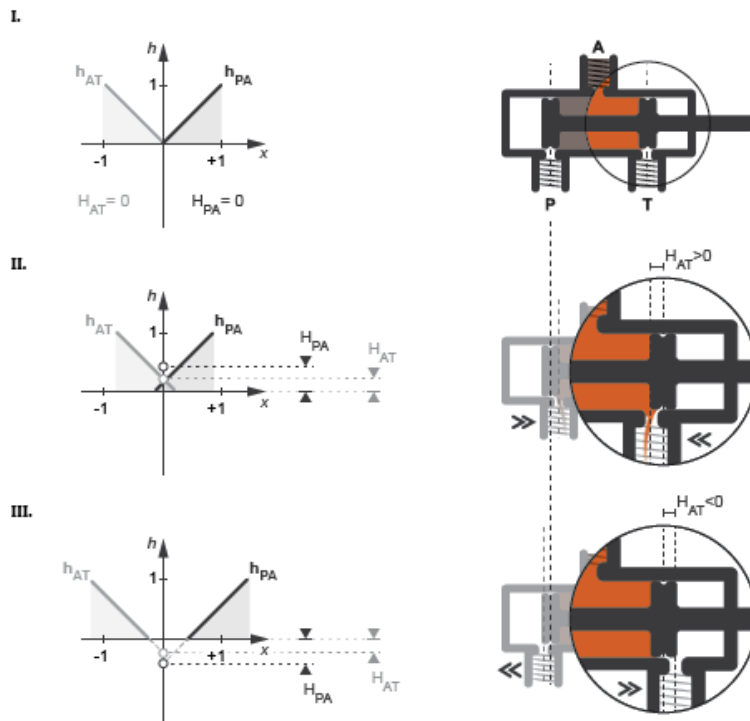

Opening Characteristics

It is common, when picking a valve for throttling or control applications, to match the flow characteristic of the valve to the system it is to regulate.

The flow characteristic relates the opening of the valve to the input that produces it, often spool travel. Here, the opening is expressed as a sonic conductance, flow coefficient, or restriction area (the choice between them being given by the **Valve parameterization** setting). The control input is the orifice opening fraction (a function of the spool displacement specified at port S).

The flow characteristic is normally given at steady state, with the inlet at a constant, carefully controlled pressure. This (inherent) flow characteristic depends only on the valve and it can be linear or nonlinear; the most common examples of the latter being the quick-opening and equal-percentage types. To capture such flow characteristics, the block provides a choice of opening parameterization (specified in the block parameter of the same name):

- **Linear** — The sonic conductance (C) is a linear function of the orifice opening fraction (h). In the default valve parameterization of Sonic conductance, the end points of the line are obtained at opening fractions of 0 and 1 from the **Sonic conductance and leakage flow** and **Sonic conductance at maximum flow** block parameters.

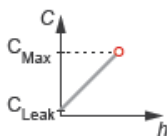

- **Tabulated data** — The sonic conductance is a general function (linear or nonlinear) of the orifice opening fraction. The function is specified in tabulated form, with the columns of the table

deriving, in the default valve parameterization, from the **Opening fraction vector** and **Sonic conductance vector** block parameters.

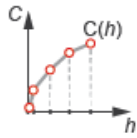

(If the **Valve parameterization** setting is other than **Sonic conductance**, the sonic conductance data is obtained by conversion from the chosen measure of valve opening (such as restriction area or flow coefficient). The opening data applies to both orifices equally.)

For controlled systems, it is important that the valve, once it is installed, be approximately linear in its flow characteristic. This (installed) characteristic depends on the remainder of the system—it is not generally the same as the inherent characteristic captured in the block. A pump, for example, may have a nonlinear characteristic that only a nonlinear valve, usually of the equal-percentage type, can adequately compensate for. It is cases of this sort that the **Tabulated data** option primarily targets.

Leakage Flow

The main purpose of leakage flow is to ensure that no section of a fluid network ever becomes isolated from the rest. Isolated fluid sections can reduce the numerical robustness of the model, slowing down the rate of simulation and, in some cases, causing it to fail altogether. While leakage flow is generally present in real valves, its exact value here is less important than its being a small number greater than zero. The leakage flow area is given in the block parameter of the same name.

Composite Structure

This block is a composite component comprising two instances of the Variable Orifice ISO 6358 (G) block connected to ports **P**, **A**, **T**, and **S** as shown below. Refer to that block for more detail on the valve parameterizations and block calculations (for example, those used to determine the mass flow rate through the ports).

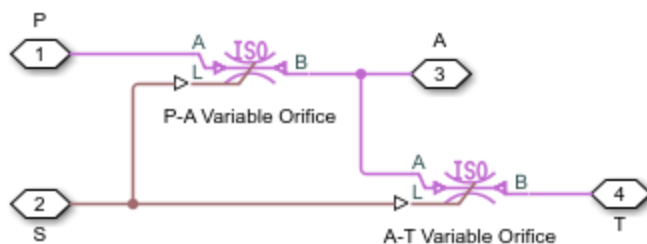

Ports

Input

S – Valve control signal, unitless

physical signal

Instantaneous displacement of the control member against its normal (unactuated) position, specified as a physical signal. The displacement is normalized against the maximum position of the control

member (that required to open the orifice fully). See the block description for more information. The signal is unitless and its instantaneous value typically (though not always) in the range of -1 to +1.

Conserving

A – Valve opening

gas

Opening through which flow can enter or exit the valve.

B – Valve opening

gas

Opening through which flow can enter or exit the valve.

T – Valve opening

gas

Opening through which flow can enter or exit the valve.

Parameters

Basic Parameters

Valve parameterization – Method by which to characterize the opening of the valve

Sonic conductance (default) | Cv coefficient (USCS) | Kv coefficient (SI) |
Restriction area

Choice of ISO method to use in the calculation of mass flow rate. All calculations are based on the Sonic conductance parameterization; if a different option is selected, the data specified is converted into equivalent sonic conductance, critical pressure ratio, and subsonic index. See the calculations of the Variable Orifice ISO 6358 (G) block for detail on the conversions.

Opening parameterization – Method by which to calculate the opening characteristics of the valve

Linear (default) | Tabulated data

Method by which to calculate the opening area of the valve. The default setting treats the opening area as a linear function of the orifice opening fraction. The alternative setting allows for a general, nonlinear relationship to be specified (in tabulated form).

Cross-sectional area at ports A, B, and T – Area normal to the flow path at the valve ports

0.01 m² (default) | positive scalar in units of area

Area normal to the flow path at the valve ports. The ports are assumed to be of the same size. The flow area specified here should (ideally) match those of the inlets of adjoining components.

Laminar flow pressure ratio – Pressure ratio at which the flow transitions between laminar and turbulent regimes

0.999 (default) | positive unitless scalar

Pressure ratio at which the flow transitions between laminar and turbulent flow regimes. The pressure ratio is the fraction of the absolute pressure downstream of the valve over that just

upstream of it. The flow is laminar when the actual pressure ratio is above the threshold specified here and turbulent when it is below. Typical values range from 0.995 to 0.999.

Reference temperature – ISO 8778 reference temperature

293.15 K (default) | scalar in units of temperature

Temperature at standard reference atmosphere, defined as 293.15 K in ISO 8778.

Reference density – ISO 8778 reference density

1.185 (default) | positive scalar in units of mass/volume

Density at standard reference atmosphere, defined as 1.185 kg/m³ in ISO 8778.

Model Parameterization

Sonic conductance at maximum flow – Measure of maximum flow rate at reference upstream conditions

1.6 l/s/bar (default) | positive scalar in units of volume/time/pressure

Equivalent measure of the maximum flow rate through the valve at some reference inlet conditions, generally those outlined in ISO 8778. The flow is at a maximum when the valve is fully open and the flow velocity is choked (it being saturated at the local speed of sound). This is the value usually reported by manufacturers in technical data sheets.

Sonic conductance is defined as the ratio of the mass flow rate through the valve to the product of the pressure and density upstream of the valve inlet. This parameter is often referred to as the *C-value*.

Dependencies

This parameter is active and exposed in the block dialog box when the **Valve parameterization** setting is Sonic conductance.

Sonic conductance at leakage flow – Measure of minimum flow rate at reference upstream conditions

1e-5 l/s/bar (default) | positive scalar in units of volume/time/pressure

Equivalent measure of the minimum flow rate allowed through the valve at some reference inlet conditions, generally those outlined in ISO 8778. The flow is at a minimum when the valve is maximally closed and only a small leakage area—due to sealing imperfections, say, or natural valve tolerances—remains between its ports.

Sonic conductance is defined as the ratio of the mass flow rate through the valve to the product of the pressure and density upstream of the valve inlet. This parameter is often referred to in the literature as the *C-value*.

This parameter serves primarily to ensure that closure of the valve does not cause portions of the gas network to become isolated (a condition known to cause problems in simulation). The exact value specified here is less important than its being a (very small) number greater than zero.

Dependencies

This parameter is active and exposed in the block dialog box when the **Valve parameterization** setting is Sonic conductance.

Critical pressure ratio — Back-pressure ratio, at reference upstream conditions, at which the flow rate is a maximum

0.3 (default) | positive and unitless scalar

Ratio of downstream to upstream absolute pressures at which the flow becomes choked (and its velocity becomes saturated at the local speed of sound). This parameter is often referred to in the literature as the *b-value*. Enter a number greater than or equal to zero and smaller than the **Laminar flow pressure ratio** block parameter.

Dependencies

This parameter is active and exposed in the block dialog box when the **Valve parameterization** setting is `Sonic conductance`.

Subsonic index — Exponent used to more accurately characterize flow in the subsonic regime

0.5 (default) | positive unitless scalar

Empirical exponent used to more accurately calculate the mass flow rate through the valve when the flow is subsonic. This parameter is sometimes referred to as the *m-index*. Its value is approximately 0.5 for valves (and other components) whose flow paths are fixed.

Dependencies

This parameter is active and exposed in the block dialog box when the **Valve parameterization** setting is `Sonic conductance`.

Cv coefficient (USCS) at maximum flow — Flow coefficient of the fully open valve expressed in US customary units0.4 (default) | positive scalar in units of ft^3/min

Flow coefficient of the fully open valve, expressed in the US customary units of ft^3/min (as described in NFPA T3.21.3). This parameter measures the relative ease with which the gas will traverse the valve when driven by a given pressure differential. This is the value generally reported by manufacturers in technical data sheets.

Dependencies

This parameter is active and exposed in the block dialog box when the **Valve parameterization** setting is `Cv coefficient (USCS)`.

Cv coefficient (USCS) at leakage flow — Flow coefficient of the maximally closed valve expressed in US customary units1e-6 (default) | positive scalar in units of ft^3/min

Flow coefficient of the maximally closed valve, expressed in the US customary units of ft^3/min (as described in NFPA T3.21.3). This parameter measures the relative ease with which the gas will traverse the valve when driven by a given pressure differential.

The purpose of the leakage value is primarily to ensure that closure of the valve does not cause portions of the gas network to become isolated (a condition known to cause problems in simulation). The exact value specified here is less important than its being a (very small) number greater than zero.

Dependencies

This parameter is active and exposed in the block dialog box when the **Valve parameterization** setting is **Cv coefficient (USCS)**.

Kv coefficient (SI) at maximum flow — Flow coefficient of the fully open valve expressed in SI units

0.3 (default) | positive scalar in units of m^3/hr

Flow coefficient of the fully open valve, expressed in the SI units of m^3/hr . This parameter measures the relative ease with which the gas will traverse the valve when driven by a given pressure differential. This is the value generally reported by manufacturers in technical data sheets.

Dependencies

This parameter is active and exposed in the block dialog box when the **Valve parameterization** setting is **Kv coefficient (SI)**.

Kv coefficient (SI) at leakage flow — Flow coefficient of the maximally closed valve expressed in SI units

1e-6 (default) | positive scalar in units of m^3/hr

Flow coefficient of the maximally closed valve, expressed in the SI units of m^3/hr . This parameter measures the relative ease with which the gas will traverse the valve when driven by a given pressure differential.

The purpose of the leakage value is primarily to ensure that closure of the valve does not cause portions of the gas network to become isolated (a condition known to cause problems in simulation). The exact value specified here is less important than its being a (very small) number greater than zero.

Dependencies

This parameter is active and exposed in the block dialog box when the **Valve parameterization** setting is **Kv coefficient (SI)**.

Restriction area at maximum flow — Opening area in the fully open position due to sealing imperfections

1e-4 m^2 (default) | positive scalar in units of area

Sum of the gauge pressures at the inlet and pilot port at which the valve is fully open. This value marks the end of the pressure range of the valve (over which the valve progressively opens to allow for increased flow).

Dependencies

This parameter is active and exposed in the block dialog box when the **Valve parameterization** setting is **Restriction area**.

Restriction area at leakage flow — Opening area in the maximally closed position due to sealing imperfections

1e-10 (default)

Opening area of the valve in the maximally closed position, when only internal leakage between the ports remains. This parameter serves primarily to ensure that closure of the valve does not cause portions of the gas network to become isolated (a condition known to cause problems in simulation).

The exact value specified here is less important than its being a (very small) number greater than zero.

Dependencies

This parameter is active and exposed in the block dialog box when the **Valve parameterization** setting is **Restriction area**.

Opening fraction vector — Orifice opening fractions at which to specify valve opening data

0 : 0.2 : 1 (default) | unitless vector with elements in the 0-1 range

Orifice opening fractions at which to specify the chosen measure of valve opening—sonic conductance, flow coefficient (in SI or USCS forms), or opening area.

This vector must be equal in size to that (or *those*, in the **Sonic conductance** parameterization) containing the valve opening data. The vector elements must be positive and increase monotonically in value from left to right.

Dependencies

This parameter is active and exposed in the block dialog box when the **Opening parameterization** setting is **Tabulated data**.

Sonic conductance vector — Vector of sonic conductances at given orifice opening fractions

[1e-05, .32, .64, .96, 1.28, 1.6] l/s/bar (default) | vector with units of volume/time/pressure

Sonic conductances at the breakpoints given in the **Opening fraction vector** parameter. This data forms the basis for a tabulated function relating the orifice opening fraction, sonic conductance, and critical pressure ratio. Linear interpolation is used within the tabulated data range; nearest-neighbor extrapolation is used outside of it. The two vectors—of sonic conductance and orifice opening fractions—must be of the same size.

Dependencies

This parameter is active and exposed in the block dialog box when the **Valve parameterization** setting is **Sonic conductance** and the **Opening parameterization** setting is **Tabulated data**.

Critical pressure ratio vector — Vector of critical pressure ratios at given orifice opening fractions

0.3 * ones(1, 6) (default) | unitless vector

Critical pressure ratios at the breakpoints given in the **Opening fraction vector** parameter. This data forms the basis for a tabulated function relating the orifice opening fraction, sonic conductance, and critical pressure ratio. Linear interpolation is used within the tabulated data range; nearest-neighbor extrapolation is used outside of it. The two vectors—of critical pressure ratios and orifice opening fractions—must be of the same size.

The values specified here must each be greater than or equal to zero and smaller than the **Laminar flow pressure ratio** block parameter.

Dependencies

This parameter is active and exposed in the block dialog box when the **Valve parameterization** setting is **Sonic conductance** and the **Opening parameterization** setting is **Tabulated data**.

Cv coefficient (USCS) vector – Vector of flow coefficients, in USCS units, at given orifice opening fractions[1e-06, .08, .16, .24, .32, .4] (default) | vector in units of ft³/min

Flow coefficients, expressed in US customary units of ft³/min, at the breakpoints given in the **Opening fraction vector**. This data forms the basis for a tabulated function relating the two variables. Linear interpolation is used within the tabulated data range; nearest-neighbor extrapolation is used outside of it. The two vectors—of flow coefficients and orifice opening fractions—must be of the same size.

Dependencies

This parameter is active and exposed in the block dialog box when the **Valve parameterization** setting is **Cv coefficient (USCS)** and the **Opening parameterization** setting is **Tabulated data**.

Kv coefficient (SI) vector – Vector of flow coefficients, in SI units, at given orifice opening fractions[1e-06, .06, .12, .18, .24, .3] (default) | vector in units of m³/hr

Flow coefficients, expressed in SI units of m³/hr, at the breakpoints given in the **Opening fraction vector** parameter. This data forms the basis for a tabulated function relating the two variables. Linear interpolation is used within the tabulated data range; nearest-neighbor extrapolation is used outside of it. The two vectors—of flow coefficients and orifice opening fractions—must be of the same size.

Dependencies

This parameter is active and exposed in the block dialog box when the **Valve parameterization** setting is **Kv coefficient (SI)** and the **Opening parameterization** setting is **Tabulated data**.

Restriction area vector – Vector of opening areas at given orifice opening fractions[1e-10, 2e-06, 4e-06, 6e-06, 8e-06, 1e-05] m² (default) | vector in units of area

Opening areas at the breakpoints given in the **Opening fraction vector** parameter. This data forms the basis for a tabulated function relating the two variables. Linear interpolation is used within the tabulated data range; nearest-neighbor extrapolation is used outside of it. The two vectors—of opening areas and orifice opening fractions—must be of the same size.

Dependencies

This parameter is active and exposed in the block dialog box when the **Valve parameterization** setting is **Restriction area** and the **Opening parameterization** setting is **Tabulated data**.

Smoothing factor – Amount of smoothing to apply to the valve opening function

0 (default) | positive unitless scalar

Amount of smoothing to apply to the opening function of the valve. This parameter determines the widths of the regions to be smoothed—one located at the fully open position, the other at the fully closed position.

The smoothing superposes on each region of the opening function a nonlinear segment (a third-order polynomial function, from which the smoothing arises). The greater the value specified here, the greater the smoothing is, and the broader the nonlinear segments become. See the Variable Orifice ISO 6358 (G) block for the impact of the smoothing on the block calculations.

At the default value of θ , no smoothing is applied. The transitions to the maximally closed and fully open positions then introduce discontinuities (associated with zero-crossings). These can slow down the rate of simulation.

Valve Opening Fraction Offsets

Between Ports P and A — Opening fraction offset for the P-A orifice

θ (default) | unitless scalar

Opening fraction of the **P-A** orifice when the spool displacement is zero. The valve is then in the normal position. The opening fraction measures the distance of a land of the spool to its appointed orifice (here **P-A**), normalized by the maximum such distance. It is unitless and (generally) between θ and 1.

Between Ports A and T — Opening fraction offset for the A-T orifice

θ (default) | unitless scalar

Opening fraction of the **A-T** orifice when the spool displacement is zero. The valve is then in the normal position. The opening fraction measures the distance of a land of the spool to its appointed orifice (here **A-T**), normalized by the maximum such distance. It is unitless and (generally) between θ and 1.

Extended Capabilities

C/C++ Code Generation

Generate C and C++ code using Simulink® Coder™.

See Also

Variable Orifice ISO 6358 (G) | 2-Way Directional Valve (G) | 4-Way Directional Valve (G)

Introduced in R2018b

3-Way Directional Valve (TL)

Valve for routing flow at the junction of three lines

Library: Simscape / Fluids / Thermal Liquid / Valves & Orifices / Directional Control Valves



Description

The 3-Way Directional Valve block models the flow through a directional control valve with three ports (**P**, **T**, and **A**) and two flow paths (the lines **P-A** and **A-T**). The ports connect to what in a typical system are a pump (**P**), a tank (**T**), and a single-acting actuator (**A**). The paths each contain a variable orifice that opens in proportion to the displacement of a control member—often a ball, spool, or diaphragm, associated with the signal at port **S**. This valve serves as a switch by which to partition the flow between the branches of a three-pronged junction.

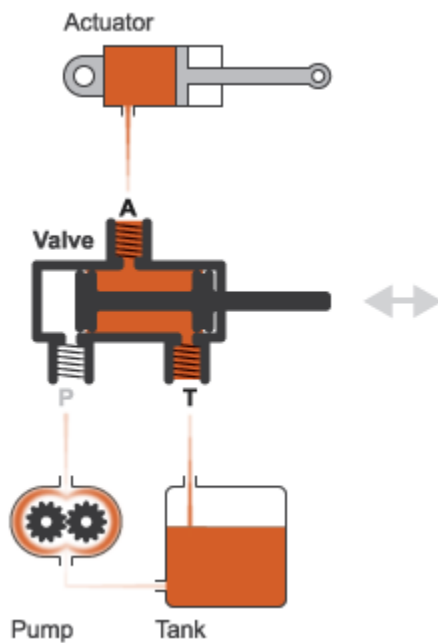

Typical Valve Setup

Valve Positions

The valve is continuously variable, which is to say that it shifts smoothly between positions. Of these there are three: one normal and two working. The normal position is that to which the valve reverts when the control member is no longer being actuated. The orifices are both typically closed in this position. The working positions are those to which the valve moves when the control member is maximally actuated. One orifice is typically closed in this position while the other is fully open. The exact opening states of the orifices depend on the opening offsets specified in the block dialog box.

The working positions are shown in the figure in the default case of a valve without opening offsets. One, labeled **I**, corresponds to the **A-T** orifice being maximally open and the **P-A** orifice maximally closed. The other, labeled **II**, corresponds to the reverse arrangement, with the **P-A** orifice being maximally open and the **A-T** orifice maximally closed. At points between the normal and working positions, one orifice is partially open while the other is fully closed. Note that no physical connection exists between ports **P** and **T** and therefore that no flow can develop across them.

I.

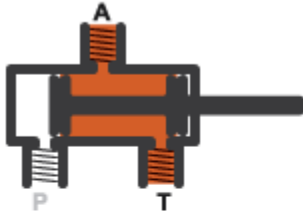

II.

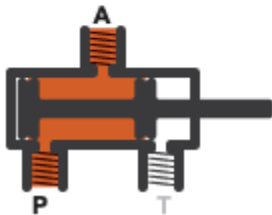

Valve Opening

Which position the valve is in depends on the control member coordinates relative to the **P-A** and **A-T** orifices—lengths referred to here as the *orifice openings*. These are calculated during simulation from their opening offsets, each specified as a block parameter in the block dialog box, and from the control member displacement, given by the physical signal at port **S**. For the **P-A** orifice:

$$h_{PA} = h_{PA0} + x,$$

where:

- h_{PA} is the **P-A** orifice opening.
- h_{PA0} is the **P-A** opening offset.
- x is the control member displacement. A control member displacement of zero corresponds to a valve that is in the normal state.

For the **A-T** orifice:

$$h_{AT} = h_{AT0} + x,$$

where:

- h_{AT} is the **A-T** orifice opening.
- h_{AT0} is the **A-T** opening offset.

An orifice cracks opens when its calculated opening (variable h) rises above zero. It then continues to widen with a rising opening value. In the case of the **P-A** orifice, this occurs as the control member is displaced in the positive direction. In the case of the **A-T** orifice, it occurs as the control member is displaced in the negative direction.

The orifices are each fully open when the opening value is at a specified maximum. In the linear valve parameterization, this maximum is obtained from the **Maximum valve opening** block parameter. You can set the **Area characteristics** parameter to **Different** for each flow path to specify the **Maximum valve opening** parameter separately for each orifice. In tabulated valve parameterizations, the maximum opening is obtained from the last breakpoint in the tabulated data.

Opening Offsets

The valve is by default configured so that it is fully closed when the control member displacement is zero. Such a valve is often described as being zero-lapped. It is possible, by applying an offset to the control member, to model a valve that is underlapped (partially open when the control member displacement is zero) or overlapped (fully closed up to a control member displacement equal to the applied offset). The figure shows the orifice opening as a function of the control member displacement for each case:

- **Case I:** A zero-lapped valve. The opening offsets are both zero. When the valve is in the normal position, the control member completely covers both orifices. The zero-lapped valve is completely closed when the control member displacement is exactly zero.
- **Case II:** An underlapped valve. The opening offsets are both positive. When the valve is in the normal position, the control member covers both orifices but neither fully. The underlapped valve is always at least partially open.
- **Case III:** An overlapped valve. The opening offsets are both negative. The control member completely covers both orifices not only in the normal position but over a small region around it. The overlapped valve is fully closed until the control member crosses the opening offset of either orifice.

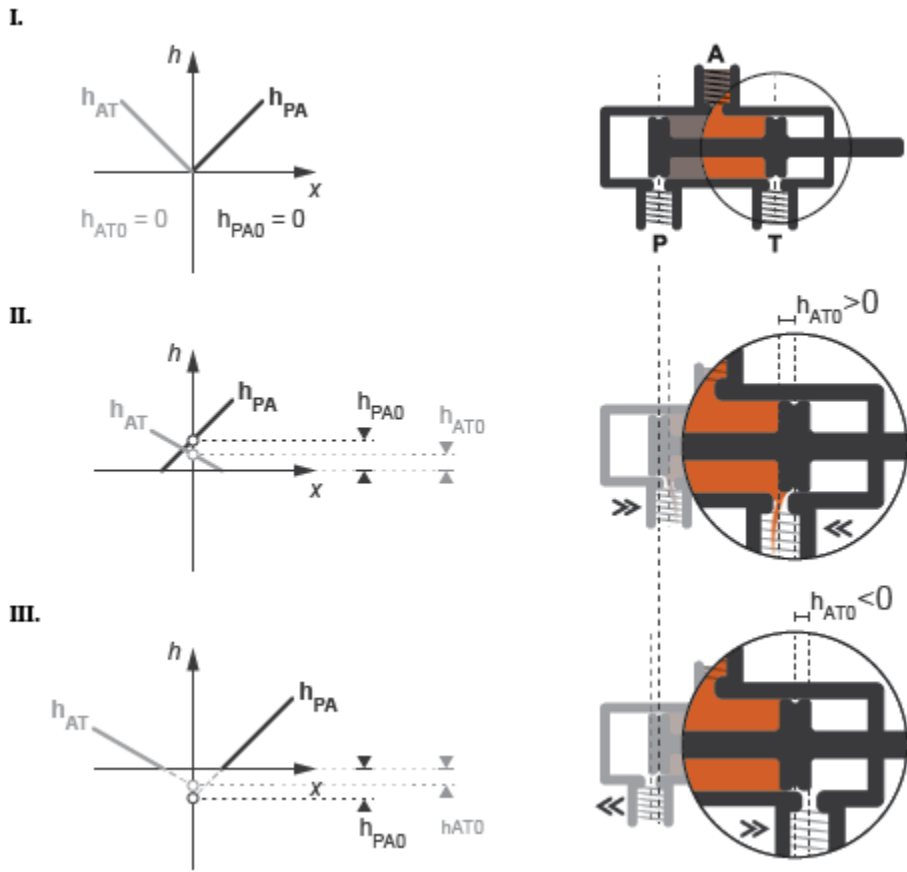

Opening Characteristics

The orifice openings serve during simulation to calculate the mass flow rates through the orifices. The calculation can be a direct mapping from opening to flow rate or an indirect conversion, first from opening to orifice area and then from orifice area to mass flow rate. The calculation, and the data required for it, depend on the setting of the **Valve parameterization** block parameter:

- **Linear area-opening relationship** — Calculate the valve opening area from the control member position and from it obtain the mass flow rate through the valve. The opening area is assumed to vary linearly with the control member position. The slope of the linear expression is determined from the **Maximum valve opening** and **Maximum opening area** block parameters.

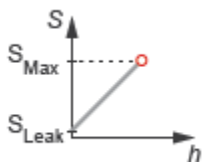

- **Tabulated data - Area vs. opening** — Calculate the valve opening area from the control member position and from it obtain the mass flow rate through the valve. The opening area can vary nonlinearly with the control member position. The relationship between the two is given by the tabulated data in the **Valve opening vector** and **Opening area vector** block parameters.

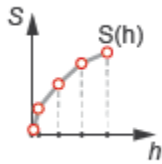

- Tabulated data - Mass flow rate vs. opening and pressure drop — Calculate the mass flow rate directly from the control member position and the pressure drop across the valve. The relationship between the three variables can be nonlinear and it is given by the tabulated data in the **Valve opening vector**, **Pressure drop vector**, and **Mass flow rate table** block parameters.

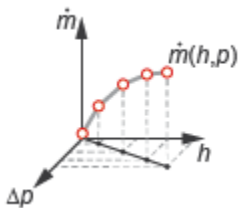

Leakage Flow

The primary purpose of the leakage flow rate of a closed valve is to ensure that at no time a portion of the thermal liquid network becomes isolated from the remainder of the model. Such isolated portions reduce the numerical robustness of the model and can slow down simulation or cause it to fail. Leakage flow is generally present in real valves but in a model its exact value is less important than its being a small number greater than zero. The leakage flow rate is determined from the **Leakage area** block parameter.

Pressure Loss and Recovery

The pressure drop in the valve is calculated from an empirical parameter known as the discharge coefficient (obtained from the **Discharge coefficient** block parameter). The calculation captures the effect of flow regime, with the pressure drop being proportional to the mass flow rate when the flow is laminar and to the square of the same when the flow is turbulent. Also captured is the pressure recovery that in real valves occurs between the vena contracta (the narrowest aperture of the valve) and the outlet, which generally lies a small distance away.

Composite Component Structure

This block is a composite component comprising two Variable Area Orifice (TL) blocks connected as shown in the figure. A single control signal actuates the two blocks simultaneously. The **Orifice orientation** block parameters are set so that a positive signal acts to open one orifice while closing the other. The opening offsets are applied to the appropriate blocks. Refer to the Variable Area Orifice (TL) block for detail on the opening area calculations.

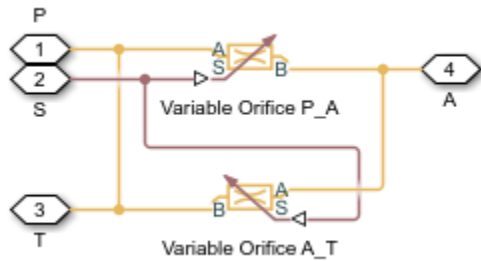

Ports

Input

S – Control member displacement in m

physical signal

Displacement, in m, of the valve control member.

Conserving

P – Flow passage

thermal liquid

Opening through which the flow can enter or exit the valve. This port is typically connected to a fluid supply line.

T – Flow passage

thermal liquid

Opening through which the flow can enter or exit the valve. This port is typically connected to a fluid return line.

A – Flow passage

thermal liquid

Opening through which the flow can enter or exit the valve. This port is typically connected to an actuation line.

Parameters

Basic Parameters

Area characteristics – Choice of identical or different orifice opening characteristics

Identical for all flow paths (default) | Different for each flow path

Assumption to make in the opening characteristics of the valve orifices. The default setting attributes the same opening characteristics to each orifice. The maximum opening area and the orifice opening at which it occurs are then the same for all orifices. Use the alternate setting to specify these parameters separately for each orifice.

Valve parameterization — Method by which to model the opening characteristics of the valve

Linear area-opening relationship (default) | Tabulated data - Area vs. opening |
Tabulated data - Mass flow rate vs. opening and pressure drop

Method by which to model the opening characteristics of the valve. The default setting prescribes a linear relationship between the valve opening area and the valve opening. The alternative settings allow for a general, nonlinear relationship to be specified in tabulated form, in one case between the opening area and the control member position (the valve opening), in the other case between the mass flow rate and both the valve opening and the pressure drop between the ports.

Leakage area — Opening area of the valve in the maximally closed position

$1e-10 \text{ m}^2$ (default) | positive scalar in units of area

Opening area of the valve in the fully closed position, when only internal leakage between its ports remains. This parameter serves primarily to ensure that closure of the valve does not cause portions of the thermal liquid network to become isolated. The exact value specified here is less important than its being a small number greater than zero.

Dependencies

This parameter is active when the **Valve parameterization** block parameter is set to Linear area-opening relationship.

Cross-sectional area at ports A, P, and T — Flow area at the thermal liquid ports

0.01 m (default) | positive scalar in units of area

Area normal to the flow path at each port. The ports are assumed to be equal in size. The flow area specified here should match those of the inlets of those components to which the valve connects.

Characteristic longitudinal length — Measure of the length of the flow path through the valve

0.1 m (default) | positive scalar in units of length

Average distance traversed by the fluid as it travels from inlet to outlet. This distance is used in the calculation of the internal thermal conduction that occurs between the two ports (as part of the smoothed upwind energy scheme employed in the thermal liquid domain).

Discharge coefficient — Empirical factor defined as the ratio of actual to ideal mass flow rates

0.7 (default) | positive unitless scalar

Ratio of the actual flow rate through the valve to the theoretical value that it would have in an ideal valve. This semi-empirical parameter measures the flow allowed through the valve: the greater its value, the greater the flow rate. Refer to the valve data sheet, if available, for this parameter.

Critical Reynolds number — Reynolds number at the boundary between laminar and turbulent flow regimes

12 (default) | positive unitless scalar

Reynolds number at which the flow is assumed to transition between laminar and turbulent regimes.

Model Parameterization

Maximum valve opening — Control member position at which the opening area is at a maximum

5e-3 m (default) | positive scalar in units of length

Value of the orifice opening at which an orifice is considered to be fully open. The opening area of the orifice is then at a maximum. The maximum opening is used to calculate the slope of the linear expression relating the orifice opening area to the orifice opening.

Dependencies

This parameter is active when the **Valve parameterization** block parameter is set to Linear area-opening relationship.

Maximum opening area — Opening area of the valve in the fully open position

1e-4 m² (default) | positive scalar in units of area

Opening area of an orifice when its orifice opening has the value specified in the **Maximum valve opening** block parameter. The maximum opening area parameter is used to calculate the slope of the linear expression relating the orifice opening area to the orifice opening.

Dependencies

This parameter is active when the **Valve parameterization** block parameter is set to Linear area-opening relationship.

Smoothing factor — Measure of the amount of smoothing to apply to the opening area function

0.01 (default) | positive unitless scalar

Measure of the amount of smoothing to apply to the opening area function. This parameter determines the widths of the regions to be smoothed, one being at the fully open position, the other at the fully closed position. The smoothing superposes on the linear opening area function two nonlinear segments, one for each region of smoothing. The greater the value specified, the greater the smoothing and the broader the nonlinear segments.

Dependencies

This parameter is active when the **Valve parameterization** block parameter is set to Linear area-opening relationship.

Valve opening vector — Vector of control member positions at which to tabulate the valve opening areas

[-0.002, 0, 0.002, 0.005, 0.015] m (default) | vector of positive numbers in units of length

Vector of control member positions at which to specify—dependent on the valve parameterization—the opening area of the valve or its mass flow rate. The vector elements must increase monotonically from left to right. This vector must be equal in size to that specified in the **Opening area vector** block parameter or to the number of rows in the **Mass flow rate table** block parameter.

This data serves to construct a one-way lookup table by which to determine, from the control member position, the opening area of the valve or a two-way lookup table by which to determine, from the control member position and pressure drop, the mass flow rate of the valve. Data is handled with linear interpolation (within the tabulated data range) and nearest-neighbor extrapolation (outside of the data range).

Dependencies

This parameter is active when the **Valve parameterization** block parameter is set to Tabulated data - Area vs. opening.

Opening area vector — Vector of opening areas at the specified valve opening breakpoints

[1e-09, 2.0352e-07, 4.0736e-05, 0.00011438, 0.00034356] m² (default) | vector of positive numbers in units of area

Vector of opening areas corresponding to the breakpoints defined in the **Valve opening vector** block parameter. The vector elements must increase monotonically from left to right (with increasing control member position). This vector must be equal in size to the number of valve opening breakpoints.

This data serves to construct a one-way lookup table by which to determine from the control member position the opening area of the valve. Data is handled with linear interpolation (within the tabulated data range) and nearest-neighbor extrapolation (outside of the data range).

Dependencies

This parameter is active when the **Valve parameterization** block parameter is set to Tabulated data - Area vs. opening.

Pressure drop vector — Vector of pressure drops at which to tabulate the mass flow rates

[-0.1, 0.3, 0.5, 0.7] MPa (default) | vector in units of pressure

Vector of pressure differentials from port **A** to port **B** at which to specify the mass flow rate of the valve. The vector elements must increase monotonically from left to right. This vector must be equal in size to the number of columns in the **Mass flow rate table** block parameter.

This data serves to construct a two-way lookup table by which to determine, from the control member position and pressure drop, the opening area of the valve. Data is handled with linear interpolation (within the tabulated data range) and nearest-neighbor extrapolation (outside of the data range).

Dependencies

This parameter is active when the **Valve parameterization** block parameter is set to Tabulated data - Mass flow rate vs. opening and pressure drop.

Mass flow rate table — Matrix of mass flow rates at the specified valve opening and pressure drop breakpoints

[-1e-05, 1.7e-05, 2e-05, 2.6e-05; -.002, .0035, .0045, .0053; -.4, .7, .9, 1.06; -1.13, 1.96, 2.5, 3; -3.45, 6, 7.7, 9.13] kg/s (default) | matrix in units of mass/time

Matrix of mass flow rates corresponding to the breakpoints defined in the **Valve opening vector** and **Pressure drop vector** block parameters. The control member position increases from row to row from top to bottom. The pressure drop increases from column to column from left to right. The mass flow rate must increase monotonically in the same directions (with increasing control member position and increasing pressure drop).

This data serves to construct a two-way lookup table by which to determine, from the control member position and pressure drop, the opening area of the valve. Data is handled with linear interpolation

(within the tabulated data range) and nearest-neighbor extrapolation (outside of the data range). Ensure that the number of rows is equal to the size of the **Opening area vector** block parameter and that the number of columns is equal to the size of the **Pressure drop vector** block parameter.

Dependencies

This parameter is active when the **Valve parameterization** block parameter is set to Tabulated data - Mass flow rate vs. opening and pressure drop.

Reference inflow temperature — Inlet temperature at which to specify the tabulated data

293.15 K (default) | positive scalar in units of temperature

Nominal inlet temperature, with reference to absolute zero, at which to specify the tabulated data. This parameter is used to adjust the mass flow rate according to the temperature measured during simulation.

Dependencies

This parameter is active when the **Valve parameterization** block parameter is set to Tabulated data - Mass flow rate vs. opening and pressure drop.

Reference inflow pressure — Inlet pressure at which to specify the tabulated data

0.101325 MPa (default) | positive scalar in units of pressure

Nominal inlet pressure, with reference to absolute zero, at which to specify the tabulated data. This parameter is used to adjust the mass flow rate according to the pressure measured during simulation.

Dependencies

This parameter is active when the **Valve parameterization** block parameter is set to Tabulated data - Mass flow rate vs. opening and pressure drop.

Valve Opening Offsets**Between P and A — Control member offset from the centered position relative to the P-A orifice**

0 m (default) | positive scalar in units of length

Distance by which to offset the valve control member from its centered (zero) position relative to the **P-A** orifice. This parameter determines the control member *displacement*, specified via port **S**, at which the **P-A** orifice is fully closed. Note that the control member *position* at which the valve is fully closed is always at zero. Set all opening offsets to positive values to model an underlapped valve or to negative values to model an overlapped valve.

Between A and T — Control member offset from the centered position relative to the A-T orifice

0 m (default) | positive scalar in units of length

Distance by which to offset the valve control member from its centered (zero) position relative to the **A-T** orifice. This parameter determines the control member *displacement*, specified via port **S**, at which the **A-T** orifice is fully closed. Note that the control member *position* at which the valve is fully closed is always at zero. Set all opening offsets to positive values to model an underlapped valve or to negative values to model an overlapped valve.

Extended Capabilities

C/C++ Code Generation

Generate C and C++ code using Simulink® Coder™.

See Also

Variable Area Orifice (TL) | 2-Way Directional Valve (TL) | 4-Way Directional Valve (TL) | Check Valve (TL)

Introduced in R2016a

3-Zone Pipe (2P)

Conduit for the transport of a phase-changing fluid with heat transfer

Library: Simscape / Fluids / Two-Phase Fluid / Pipes & Fittings



Description

The Pipe (2P) block models a pipe with a phase-changing fluid. Each fluid phase is called a *zone*, which is a fractional value between 0 and 1. Zones do not mix. The 3-Zone Pipe (2P) uses a boundary-following model to track the sub-cooled liquid (L), vapor-liquid mixture (M), and super-heated vapor (V) in three zones. The relative amount of space a zone occupies in the system is called a *zone length fraction* within the system.

Port **H** is a thermal port that represents the environmental temperature. The rate of heat transfer between the fluid and the environment depends on the fluid phase of each zone. The pipe wall is modeled within the block and the pipe wall temperature in each zone may be different. The pressure and temperature are influenced by fluid dynamic compressibility and the fluid zone thermal capacity.

Heat Transfer Between the Fluid and the Wall

The convective heat transfer coefficient between the fluid and the wall, α_F , varies per zone according to the Nusselt number:

$$\alpha_F = \frac{Nu k}{D_H}$$

where:

- Nu is the zone Nusselt number.
- k the average fluid thermal conductivity.
- D_H is the pipe **Hydraulic diameter**, the equivalent diameter of a non-circular pipe.

The Nusselt number used in the heat transfer coefficient is the greater of the turbulent- and laminar-flow Nusselt numbers.

For turbulent flows in the subcooled liquid or superheated vapor zones, the Nusselt number is calculated with the Gnielinski correlation:

$$Nu = \frac{\frac{f}{8}(Re-1000)Pr}{1 + 12.7\left(\frac{f}{8}\right)^{1/2}\left(Pr^{2/3} - 1\right)}$$

where:

- Re is the zone average Reynolds number.
- Pr is the zone average Prandtl number.
- f is the Darcy friction factor, calculated from the Haaland correlation:

$$\frac{1}{\sqrt{f}} = -1.8 \log \left[\left(\frac{\varepsilon}{D_H} \right)^{1.11} + \frac{6.9}{Re} \right],$$

where ε is the wall **Internal surface absolute roughness**.

For turbulent flows in the liquid-vapor mixture zone, the Nusselt number is calculated with the Cavallini-Zecchin correlation:

$$Nu = \frac{a Re_{SL}^b Pr_{SL}^c \left\{ \left[\left(\sqrt{\frac{\rho_{SL}}{\rho_{SV}}} - 1 \right) x_{Out} + 1 \right]^{1+b} - \left[\left(\sqrt{\frac{\rho_{SL}}{\rho_{SV}}} - 1 \right) x_{In} + 1 \right]^{1+b} \right\}}{(1+b) \left(\sqrt{\frac{\rho_{SL}}{\rho_{SV}}} - 1 \right) (x_{Out} - x_{In})}.$$

Where:

- Re_{SL} is the Reynolds number of the saturated liquid.
- Pr_{SL} is the Prandtl number of the saturated liquid.
- ρ_{SL} is the density of the saturated liquid.
- ρ_{SV} is the density of the saturated vapor.
- $a = 0.05$, $b = 0.8$, and $c = 0.33$.

When fins are modeled on the pipe internal surface, the heat transfer coefficient is:

$$\alpha_F = \frac{Nuk}{D_H} (1 + \eta_{Int} s_{Int}),$$

where:

- η_{Int} is the **Internal fin efficiency**.
- s_{Int} is the **Ratio of internal fins surface area to no-fin surface area**.

For laminar flows, the Nusselt number is set by the **Laminar flow Nusselt number** parameter.

Specific Enthalpy

The heat transfer rate from the fluid is based on the change in specific enthalpy in each zone:

$$Q = \dot{m}_Q (\Delta h_L + \Delta h_M + \Delta h_V),$$

where \dot{m}_Q is the mass flow rate for heat transfer. It is the pipe inlet mass flow rate, either \dot{m}_A or \dot{m}_B , depending on the direction of fluid flow.

In the liquid and vapor zones, the change in specific enthalpy is defined as:

$$\Delta h = c_p (T_H - T_I) \left[1 - \exp \left(- \frac{z S_W}{\dot{m}_Q c_p (\alpha_F^{-1} + \alpha_E^{-1})} \right) \right],$$

where:

- c_p is the specific heat of the liquid or vapor.

- T_H is the environmental temperature.
- T_I is the liquid inlet temperature.
- z is the fluid zone length fraction.
- α_E is the heat transfer coefficient between the wall and the environment.
- S_W is wall surface area:

$$S_W = \frac{4A}{D_H}L,$$

where:

- A is the pipe **Cross-sectional area**.
- L is the **Pipe length**.

Note that this wall surface area does not include fin area, which is defined in the **Ratio of external fins surface area to no-fin surface area** and **Ratio of internal fins surface area to no-fin surface area** parameters. Fins are set in proportion to the wall surface area. A value of 0 means there are no fins on the pipe wall.

In the liquid-vapor mixture zone, the change in specific enthalpy is calculated as:

$$\Delta h = (T_H - T_S) \frac{zS_W}{\dot{m}_Q(\alpha_F^{-1} + \alpha_E^{-1})},$$

where T_S is the fluid saturation temperature. It is assumed that the liquid-vapor mixture is always at this temperature.

Heat Transfer Rate

The total heat transfer between the fluid and the pipe wall is the sum of the heat transfer in each fluid phase:

$$Q_F = Q_{F,L} + Q_{F,V} + Q_{F,M}.$$

The heat transfer rate between the fluid and the pipe in the liquid zone is:

$$Q_{F,L} = \dot{m}_Q c_{p,L} [T_{W,L} - \min(T_I, T_S)] \left[1 - \exp\left(-\frac{z_L S_W \alpha_L}{\dot{m}_Q c_{p,L}}\right) \right].$$

where $T_{W,L}$ is the temperature of the wall surrounding the liquid zone.

The heat transfer rate between the fluid and the pipe in the mixture zone is:

$$Q_{F,M} = (T_H - T_{\text{Sat}}) z_M S_W \alpha_M.$$

The heat transfer rate between the fluid and the pipe in the vapor zone is:

$$Q_{F,V} = \dot{m}_Q c_{p,V} [T_{W,V} - \min(T_I, T_{\text{Sat}})] \left[1 - \exp\left(-\frac{z_V S_W \alpha_V}{\dot{m}_Q c_{p,V}}\right) \right],$$

where $T_{W,V}$ is the temperature of the wall surrounding the vapor zone.

Heat Transfer Between the Wall and the Environment

If the pipe wall has a finite thickness, the heat transfer coefficient between the wall and the environment, α_E , is defined by:

$$\frac{1}{\alpha_E} = \frac{1}{\alpha_W} + \frac{1}{\alpha_{Ext}(1 + \eta_{Ext}s_{Ext})},$$

where α_W is the heat transfer coefficient due to conduction through the wall:

$$\alpha_W = \frac{k_W}{D_H \ln\left(1 + \frac{t_W}{D_H}\right)},$$

and where:

- k_W is the **Wall thermal conductivity**.
- t_W is the **Wall thickness**.
- α_{Ext} is the **External environment heat transfer coefficient**.
- η_{Ext} is the **External fin efficiency**.
- s_{Ext} is the **Ratio of external fins surface area to no-fin surface area**.

If the wall does not have thermal mass, the heat transfer coefficient between the wall and environment equals the heat transfer coefficient of the environment, α_{Ext} .

Heat Transfer Rate

The heat transfer rate between each wall zone and the environment is:

$$Q_{H,zone} = (T_H - T_W)zS_W\alpha_E.$$

The total heat transfer between the wall and the environment is:

$$Q_H = Q_{H,L} + Q_{H,V} + Q_{H,M}.$$

Governing Differential Equations

The heat transfer rate depends on the thermal mass of the wall, C_W :

$$C_W = c_{p,W}\rho_W S_W \left(t_W + \frac{t_W^2}{D_H} \right),$$

where:

- $c_{p,W}$ is the **Wall specific heat**.
- ρ_W is the **Wall density**.

The governing equations for heat transfer between the fluid and the external environment are, for the liquid zone:

$$Q_{H,L} - Q_{F,L} = C_W \left[z_L \frac{dT_{W,L}}{dt} + \max\left(\frac{dz_L}{dt}, 0\right) (T_{W,L} - T_{W,M}) \right],$$

for the mixture zone:

$$Q_{H,M} - Q_{F,M} = C_W \left[z_M \frac{dT_{W,M}}{dt} + \min\left(\frac{dz_L}{dt}, 0\right)(T_{W,L} - T_{W,M}) + \min\left(\frac{dz_V}{dt}, 0\right)(T_{W,V} - T_{W,M}) \right],$$

and for the vapor zone:

$$Q_{H,V} - Q_{F,V} = C_W \left[z_V \frac{dT_{W,V}}{dt} + \max\left(\frac{dz_V}{dt}, 0\right)(T_{W,V} - T_{W,M}) \right].$$

Momentum Balance

The pressure differential over the pipe consists of two factors: changes in pressure due to changes in density, and changes in pressure due to friction at the pipe walls.

For turbulent flows, when the Reynolds number is above the **Turbulent flow lower Reynolds number limit**, pressure loss is calculated in terms of the Darcy friction factor. The pressure differential between port **A** and the internal node I is:

$$p_A - p_I = \left(\frac{1}{\rho_I} - \frac{1}{\rho_A^*} \right) \left(\frac{\dot{m}_A}{S} \right)^2 + \frac{f_A \dot{m}_A |\dot{m}_A| (L + L_{Add})}{2 \rho_I D_H S^2},$$

where:

- ρ_I is the fluid density at internal node I.
- ρ_A^* is the fluid density at port **A**. This is the same as ρ_A when the flow is steady-state; when the flow is transient, it is calculated from the fluid internal state with the adiabatic expression:

$$u_A^* + \frac{p_A}{\rho_A^*} + \frac{1}{2} \left(\frac{\dot{m}_A}{\rho_A^* S} \right)^2 = h + \frac{1}{2} \left(\frac{\dot{m}_A}{\rho S} \right)^2,$$

where:

- h is the average specific enthalpy, $h = h_L z_L + h_V z_V + h_M z_M$.
- ρ is the average density, $\rho = \rho_L z_L + \rho_M z_M + \rho_V z_V$.

This is due to the fact that heat transfer calculation takes place at the internal node I.

- \dot{m}_A is the mass flow rate through port **A**.
- L is the **Pipe length**.
- L_{Add} is the **Aggregate equivalent length of local resistances**, which is the equivalent length of a tube that introduces the same amount of loss as the sum of the losses due to other local resistances.

Note that the Darcy friction factor is dependent on the Reynolds number, and is calculated at both ports.

The pressure differential between port **B** and internal node I is:

$$p_B - p_I = \left(\frac{1}{\rho_I} - \frac{1}{\rho_B^*} \right) \left(\frac{\dot{m}_B}{S} \right)^2 + \frac{f_B \dot{m}_B |\dot{m}_B| (L + L_{Add})}{2 \rho_I D_H S^2}.$$

where:

- ρ_B^* is the fluid density at port **B**. This is the same as ρ_B when the flow is steady-state; when the flow is transient, it is calculated from the fluid internal state with the adiabatic expression:

$$u_B^* + \frac{p_B}{\rho_B^*} + \frac{1}{2} \left(\frac{\dot{m}_B}{\rho_B^* S} \right)^2 = h + \frac{1}{2} \left(\frac{\dot{m}_B}{\rho S} \right)^2.$$

- \dot{m}_B is the mass flow rate through port **B**.

For laminar flows, when the Reynolds number is below the **Laminar flow upper Reynolds number limit**, the pressure loss due to friction is calculated in terms of the **Laminar friction constant for Darcy friction factor**, λ . The pressure differential between port **A** and internal node I is:

$$p_A - p_I = \left(\frac{1}{\rho_I} - \frac{1}{\rho_A^*} \right) \left(\frac{\dot{m}_A}{S} \right)^2 + \frac{\lambda \mu \dot{m}_A}{2 \rho_I D_{HS}^2} \left(\frac{L + L_{Add}}{2} \right),$$

where μ is the average fluid dynamic viscosity:

$$\mu = \mu_L z_L + \mu_M z_M + \mu_V z_V.$$

The pressure differential between port **B** and internal node I is:

$$p_B - p_I = \left(\frac{1}{\rho_I} - \frac{1}{\rho_B^*} \right) \left(\frac{\dot{m}_B}{S} \right)^2 + \frac{\lambda \mu \dot{m}_B}{2 \rho_I D_{HS}^2} \left(\frac{L + L_{Add}}{2} \right).$$

For transitional flows, the pressure differential due to viscous friction is a smoothed blend between the values for laminar and turbulent pressure losses.

Mass Balance

The total mass accumulation rate is defined as:

$$\frac{dM}{dt} = \dot{m}_A + \dot{m}_B,$$

where M is the total fluid mass in the pipe. In terms of fluid zones, the mass accumulation rate is a function of the change in density, ρ , with respect to pressure, p , and the fluid specific internal energy, u :

$$\frac{dM}{dt} = \left[\left(\frac{d\rho}{dp} \right)_u \frac{dp}{dt} + \left(\frac{d\rho}{du} \right)_p \frac{du_{out}}{dt} + \rho_L \frac{dz_L}{dt} + \rho_M \frac{dz_M}{dt} + \rho_V \frac{dz_V}{dt} \right] V,$$

where:

- u_{out} is the specific internal energy after all heat transfer has occurred.
- V is the total fluid volume, or the volume of the pipe.

Energy Balance

The energy conversation equation is:

$$M \frac{du_{out}}{dt} + (\dot{m}_A + \dot{m}_B) u_{out} = \phi_A + \phi_B + Q_F,$$

where:

- ϕ_A is the energy flow rate at port **A**.
- ϕ_B is the energy flow rate at port **B**.
- Q_F is the heat transfer rate between the fluid and the wall.

Assumptions and Limitations

- The pipe wall is perfectly rigid.
- The flow is fully developed. Friction losses and heat transfer do not include entrance effects.
- Fluid inertia is negligible.
- The effect of gravity is negligible.
- When the pressure is above the fluid critical pressure, large values of thermal fluid properties (such as Prandtl number, thermal conductivity, and specific heat) may not accurately reflect the heat exchange in the pipe.

Ports

Output

Z – Zone length fractions

physical signal

Vector with the length fractions of the liquid, mixed-phase, and vapor zones in the pipe.

Conserving

A – Pipe opening

two-phase fluid

Opening through which the two-phase fluid flows into or out of the pipe. Ports **A** and **B** can each function as either inlet or outlet. Thermal conduction is allowed between the two-phase fluid ports and the fluid internal to the pipe (though its impact is typically relevant only at near zero flow rates).

B – Pipe opening

two-phase fluid

Opening through which the two-phase fluid flows into or out of the pipe. Ports **A** and **B** can each function as either inlet or outlet. Thermal conduction is allowed between the two-phase fluid ports and the fluid internal to the pipe (though its impact is typically relevant only at near zero flow rates).

H – Pipe wall

thermal

Thermal boundary condition at the outer surface of the pipe wall. Use this port to capture heat exchange of various kinds—for example, conductive, convective, or radiative—between the pipe wall and the environment. Heat exchange between the inner surface of the wall and the fluid is captured directly in the block.

Parameters

Geometry

Pipe length — Distance between the ports of the pipe

5 m (default) | positive scalar with units of length

Distance between the ports of the pipe. The liquid, two-phase, and vapor zones each comprise a fraction of this distance. The zone fractions can vary but their aggregate length, being the same as the distance of the pipe, is fixed.

Cross-sectional area — Internal area normal to the direction of the flow

0.01 m² (default) | positive scalar with units of area

Internal area of the pipe normal to the direction of flow. The cross section of the pipe is assumed to be constant throughout its length.

Hydraulic diameter — Diameter of a cylindrical pipe with the given cross-sectional area

0.1 m (default) | positive scalar in units of length

Ratio of the opening area of a cross section of the pipe to the perimeter of that area. The pipe is not required to be cylindrical, and its cross-section have any shape. This parameter gives the diameter that a general cross section would have if it were circular.

Viscous Friction

Aggregate equivalent length of local resistances — Minor pressure loss in the pipe expressed as a length

1 m (default) | positive scalar in units of length

Combined length of all local resistances present in the pipe. Local resistances include bends, fittings, armatures, and pipe inlets and outlets. The effect of the local resistances is to increase the effective length of the pipe. This length is added to the geometrical pipe length for friction calculations.

Internal surface absolute roughness — Average depth of surface defects on the internal surface of the pipe

15e-6 m (default) | positive scalar in units of length

Average depth of all surface defects on the internal surface of the pipe. The surface defects affect the pressure loss across the pipe in the turbulent flow regime.

Laminar flow upper Reynolds number limit — Reynolds number below which the flow is laminar

2e+3 (default) | positive unitless scalar

Reynolds number above which the pipe flow begins to transition from laminar to turbulent. This value is the maximum Reynolds number corresponding to fully developed laminar flow.

Turbulent flow lower Reynolds number limit — Reynolds number above which the flow is turbulent

4e+3 (default) | positive unitless scalar

Reynolds number below which the pipe flow begins to transition from turbulent to laminar. This value is the minimum Reynolds number corresponding to fully developed turbulent flow.

Shape factor for laminar flow viscous friction – Dimensionless factor used to capture the effect of geometry on viscous friction losses

64 (default) | positive unitless scalar

Dimensionless factor used to capture the effects of cross-sectional geometry on the viscous friction losses incurred in the laminar flow regime. Typical values are 64 for a circular cross section, 57 for a square cross section, and 62 for a rectangular cross section with an aspect ratio of 2.

Heat Transfer**External environment heat transfer coefficient – Heat transfer coefficient between the environment and the pipe wall**100 W/(m²*K) (default) | positive scalar with units of power/(area*temperature)

Heat transfer coefficient for heat exchange between the environment (at port **H**) and the outer surface of the pipe wall. If this parameter is set to *inf*, then the thermal resistance between the environment and the wall is assumed to be zero. The pipe wall then has a uniform temperature equal to that associated with port **H**.

Wall thickness – Average thickness of the pipe wall material

0 m (default) | positive scalar with units of length

Average thickness of the pipe wall material. If this value is set to 0, then both thermal resistance due to conduction through the pipe wall and thermal storage due to the thermal mass of the pipe wall are assumed to be negligible.

Wall thermal conductivity – Thermal conductivity of the pipe wall material

390 W/(m*K) (default) | positive scalar with units of power/(length*temperature)

Thermal conductivity of the pipe wall material. If this parameter is set to *inf*, then thermal resistance due to conduction through the pipe wall is assumed to be negligible.

Wall specific heat – Heat capacity per unit mass of pipe wall material

390 J/kg/K (default) | positive scalar with units of energy/(mass*temperature)

Heat capacity per unit mass of the pipe wall material. If this parameter is set to 0, then thermal storage due to the thermal mass of the pipe is assumed to be negligible.

Wall density – Mass density of the pipe wall material9e3 kg/m³ (default) | positive scalar with units of mass/volume

Mass density of the pipe wall material. If this parameter is set to 0, then thermal storage due to the thermal mass of the pipe wall is assumed to be negligible.

Ratio of external fins surface area to no-fin surface area – Ratio of heat transfer surface area with external fins to that without

0 (default) | positive unitless scalar

Ratio of the total heat transfer surface area of the fins on the external side of the pipe wall to that of the pipe wall without any fins. The presence of fins serves to enhance the convective heat transfer between the pipe wall and the environment.

External fin efficiency – Ratio of actual to ideal heat exchange rates with external fins

0.5 (default) | positive unitless scalar

Ratio of the actual heat exchange rate between the external fins and the environment to its ideal value (if the fins were entirely held at the temperature of the pipe wall). This parameter is a function of fin geometry.

Ratio of internal fins surface area to no-fin surface area — Ratio of heat transfer surface area with internal fins to that without

0 (default) | positive unitless scalar

Ratio of the total heat transfer surface area of the fins on the internal side of the pipe wall to that of the pipe wall without any fins. The presence of fins serves to enhance the convective heat transfer between the pipe wall and the fluid.

Internal fin efficiency — Ratio of actual to ideal heat exchange rates with internal fins

0.5 (default) | positive unitless scalar

Ratio of the actual heat exchange rate between the internal fins and the environment to its ideal value (if the fins were entirely held at the temperature of the pipe wall). This parameter is a function of fin geometry.

Nusselt number for laminar flow heat transfer — Ratio of convective to conductive heat exchange rates in the laminar flow regime

3.66 (default)

Ratio of convective to conductive heat exchange rates in the laminar flow regime. This parameter is a function of pipe cross section geometry. Typical values are 3.66 for a circular cross section, 2.98 for a square cross section, and 3.39 for a rectangular cross section with an aspect ratio of 2.

Effects and Initial Conditions Tab

Initial fluid energy specification — Thermodynamic variable whose initial value to set

Temperature (default) | Vapor quality | Vapor void fraction | Specific enthalpy | Specific internal energy

Thermodynamic variable in terms of which to define the initial conditions of the component.

Initial pressure — Absolute pressure at the start of simulation

0.101325 MPa (default) | scalar with units of pressure

Pressure in the pipe at the start of simulation, specified against absolute zero.

Initial temperature — Absolute temperature at the start of simulation

293.15 K (default) | scalar or two-element vector with units of temperature

Fluid temperature in the pipe at the start of simulation. This parameter can be a scalar or a 2-element vector. If it is a scalar, the initial temperature is assumed to be uniform throughout the pipe. If it is a vector, the initial temperature is assumed to vary linearly between the ports. The first vector element gives the initial temperature at the inlet and the second vector element that at the outlet.

Dependencies

This parameter is active when the **Initial fluid energy specification** option is set to Temperature.

Initial vapor quality — Mass fraction of vapor at the start of simulation

0.5 (default) | unitless scalar between 0 and 1

Vapor quality, or mass fraction of vapor, in the pipe at the start of simulation. This parameter can be a scalar or a 2-element vector. If it is a scalar, the initial vapor quality is assumed to be uniform throughout the pipe. If it is a vector, the initial vapor quality is assumed to vary linearly between the ports. The first vector element gives the initial vapor quality at the inlet and the second vector element that at the outlet.

Dependencies

This parameter is active when the **Initial fluid energy specification** option is set to Vapor quality.

Initial vapor void fraction – Volume fraction of vapor at the start of simulation

0.5 (default) | unitless scalar between 0 and 1

Vapor void fraction, or vapor volume fraction, in the pipe at the start of simulation. This parameter can be a scalar or a 2-element vector. If it is a scalar, the initial vapor void fraction is assumed to be uniform throughout the pipe. If it is a vector, the initial vapor void fraction is assumed to vary linearly between the ports. The first vector element gives the initial vapor void fraction at the inlet and the second vector element that at the outlet..

Dependencies

This parameter is active when the **Initial fluid energy specification** option is set to Vapor void fraction.

Initial specific enthalpy – Specific enthalpy at the start of simulation

1500 kJ/kg (default) | scalar with units of energy/mass

Specific enthalpy of the fluid in the pipe at the start of simulation. This parameter can be a scalar or a 2-element vector. If it is a scalar, the initial specific enthalpy is assumed to be uniform throughout the pipe. If it is a vector, the initial specific enthalpy is assumed to vary linearly between the ports. The first vector element gives the initial specific enthalpy at the inlet and the second vector element that at the outlet.

Dependencies

This parameter is active when the **Initial fluid energy specification** option is set to Specific enthalpy.

Initial specific internal energy – Specific internal energy at the start of simulation

1500 kJ/kg (default) | scalar with units of energy/mass

Specific internal energy of the fluid in the pipe at the start of simulation. This parameter can be a scalar or a 2-element vector. If it is a scalar, the initial specific internal energy is assumed to be uniform throughout the pipe. If it is a vector, the initial specific internal energy is assumed to vary linearly between the ports. The first vector element gives the initial specific internal energy at the inlet and the second vector element that at the outlet.

Dependencies

This parameter is active when the **Initial fluid energy specification** option is set to Specific internal energy.

References

[1] White, F.M., *Fluid Mechanics*, 7th Ed, Section 6.8. McGraw-Hill, 2011.

[2] Çengel, Y.A., *Heat and Mass Transfer—A Practical Approach*, 3rd Ed, Section 8.5. McGraw-Hill, 2007.

Extended Capabilities

C/C++ Code Generation

Generate C and C++ code using Simulink® Coder™.

See Also

Receiver Accumulator (2P)

Introduced in R2018b

4-Way Directional Valve

Four-port three-position directional control valve

Library: Simscape / Fluids / Hydraulics (Isothermal) / Valves / Directional Valves

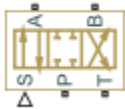

Description

The 4-Way Directional Valve block represents a directional control valve with four ports and three positions, or flow paths. The ports connect to what in a typical model are a hydraulic pump (port **P**), a storage tank (port **T**), and a double-acting actuator (ports **A** and **B**). Fluid can flow from the pump to the actuator via path **P-A** or **P-B** and from the actuator to the tank via path **A-T** or **B-T**—depending on the working side of the actuator.

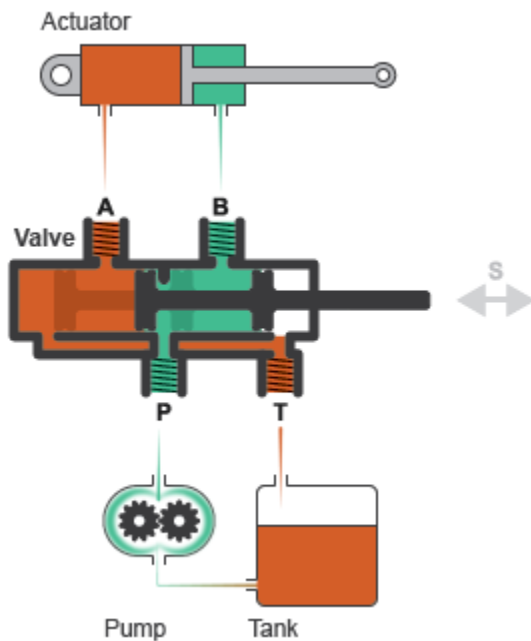

Typical Valve Setup

In the default configuration, one valve position corresponds to the **P-A** and **B-T** flow paths maximally open and the **P-B** and **A-T** flow paths maximally closed (position **I** in the figure). Another valve position corresponds to the inverse configuration, with **P-B** and **A-T** maximally open and **P-A** and **B-T** maximally closed (position **II**). The third valve position corresponds to all flow paths maximally closed (position **III**). A translating spool serves as the valve control member and determines the position that the valve is in—**I**, **II**, **III**, or in between.

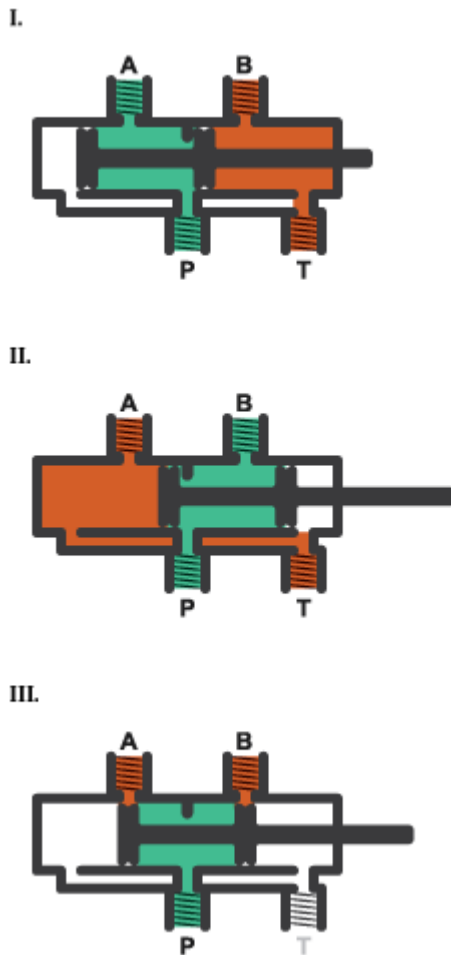

Valve Positions

Physical signal port **S** controls the spool displacement. In the default configuration, a zero displacement signal corresponds to valve position **III**. A positive displacement signal shifts the spool toward valve position **I**. A negative displacement shifts the spool toward valve position **II**. The spool displacement acts indirectly by setting the spool position relative to each flow path—a length known here as the *orifice opening*. The orifice opening in turn determines the opening area of the respective flow path.

Orifice Openings

The orifice opening of a flow path depends partly on its *opening offset*—the orifice opening of a flow path at zero spool displacement. The block models only the effects of the opening offsets. An offset can be due to a change in distance between ports or spool lands—the thick disks built into the spool to obstruct flow. It can also be due to a change in the thicknesses of the spool lands. The orifice openings are computed separately for each flow path in terms of the respective opening offset:

$$h_{PA} = h_{PA0} + x$$

$$h_{PB} = h_{PB0} - x$$

$$h_{AT} = h_{AT0} - x$$

$$h_{BT} = h_{BT0} + x$$

where:

- h_{PA} , h_{PB} , h_{AT} , and h_{BT} are the orifice openings of the **P-A**, **P-B**, **A-T**, and **P-B** flow paths. The orifice openings are computed during simulation.
- h_{PA0} , h_{PB0} , h_{AT0} , and h_{BT0} are the orifice opening offsets of the **P-A**, **P-B**, **A-T**, and **P-B** flow paths. The opening offsets are specified in the **Valve opening offsets** tab.
- x is the spool displacement relative to what in the zero-offset case is a fully closed valve. The spool displacement is specified through physical signal port **S**.

The figure shows the effects of the opening offsets on the orifice openings. Plot **I** corresponds to the default configuration with both opening offsets equal to zero. Plot **II** corresponds to a valve with both opening offsets greater than zero and plot **III** to a valve with both opening offsets smaller than zero. These cases are similar in behavior to zero-lapped (**I**), underlapped (**II**) and overlapped (**III**) valves. The valve schematics to the right show what the offset might look like. The circle highlights the offset in path **P-B**.

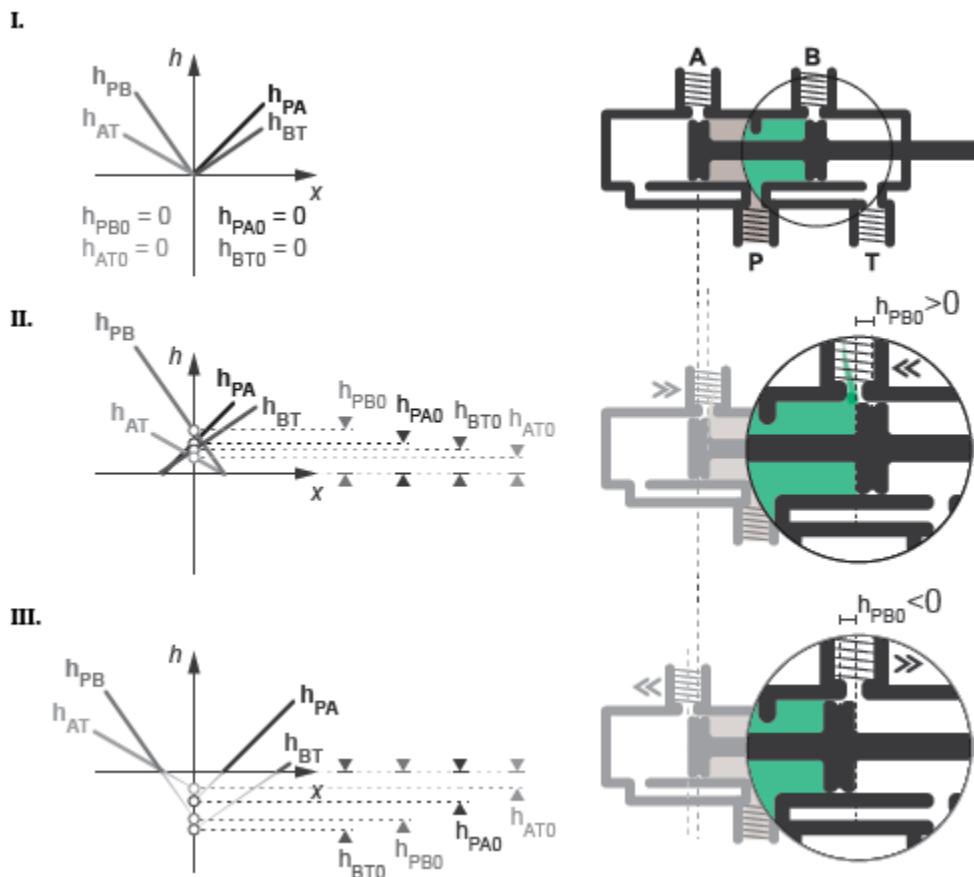

Zero (I), Positive (II), and Negative (III) Opening Offsets

An underlapped valve is always partially open and allows some flow at all spool displacements. An overlapped valve is fully closed over an extended range of spool displacements and requires longer

spool travel to open. The table summarizes the opening offsets for zero-lapped, underlapped, and overlapped valves. Other configurations are possible—e.g., with one opening offset positive and the other negative.

Valve Lapping	Opening Offsets
Zero-lapped (default)	All zero
Underlapped	All positive
Overlapped	All negative

Opening Areas

The **Model parameterization** setting determines the calculations used for the opening areas of the flow paths—or, in the **Pressure-flow characteristic** case, the volumetric flow rates. The calculations are based on orifice parameters or tabulated data sets specified in the **Model Parameterization** tab. The block uses the same data for all flow paths if the **Area characteristics** parameter in the **Basic Parameters** tab is set to **Identical** for all flow paths and different data otherwise. Model parameterizations that you can select include:

- **Maximum area and opening** — Specify the maximum opening area and the corresponding orifice opening. The opening area is a linear function of the orifice opening,

$$A_{AT} = \frac{A_{AT, Max}}{h_{AT, Max}} h_{AT} + A_{Leak},$$

where A is the opening area and h the orifice opening of a given flow path. The subscript **Max** refers to a fully open orifice and the subscript **Leak** to a fully closed orifice—one with internal leakage flow area only. The figure shows a plot of the linear function $A(h)$.

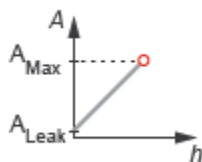

- **Area vs. opening table** — Specify the opening area at discrete orifice openings as a 1-D lookup table. The opening area is computed for a given orifice opening by interpolation or extrapolation of the tabulated data. The figure shows a conceptual plot of the tabulated function $A(h)$.

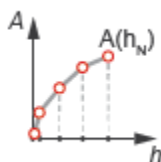

- **Pressure-flow characteristic** — Specify the volumetric flow rate at discrete orifice openings and pressure differentials as a 2-D lookup table. The opening area is computed for a given orifice opening and pressure differential by interpolation or extrapolation of the tabulated data. The figure shows a conceptual plot of the tabulated function $q(h, p)$.

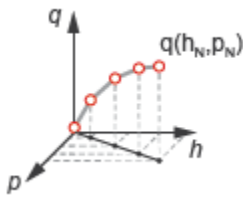

Flow Regime and Internal Leakage

Volumetric flow rates are computed analytically in the Maximum area and opening and Area vs. opening table parameterizations. The calculations are based on additional block parameters such as the flow discharge coefficient and account for the effects of flow regime—laminar or turbulent. Regime transition occurs at the specified critical laminar flow ratio or critical Reynolds number.

The Maximum area and opening and Area vs. opening table parameterizations also account for a small internal leakage area even in the fully closed state. The leakage area ensures that portions of the hydraulic network do not become isolated when a flow path is closed. Isolated, or “hanging”, network portions affect the computational efficiency of the model and can cause simulation to fail.

The effects of flow regime and internal leakage are assumed to be reflected in the tabulated flow rate data specified directly in the Pressure-flow characteristic parameterization.

Valve Configurations

The opening offsets are by default zero. This configuration corresponds to a valve with all flow paths closed in the neutral position (III in the “Valve Positions” on page 1-109 schematic). Many other configurations exist. You can model a specific configuration by setting the opening offsets as shown in the table. All opening offset parameters are in the **Valve opening offsets** tab of the block dialog box

The 4-Way Directional Valve Configurations

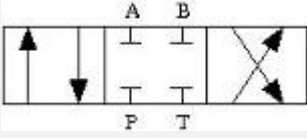
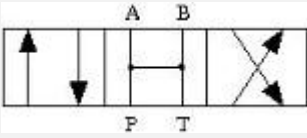
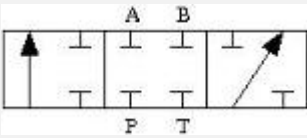
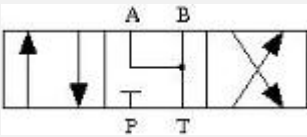
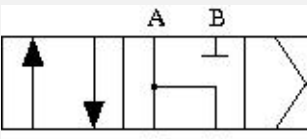
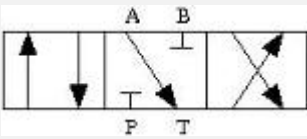
No	Configuration	Initial Openings
1		<p>All four orifices are overlapped in neutral position:</p> <ul style="list-style-type: none"> • Orifice P-A initial opening < 0 • Orifice P-B initial opening < 0 • Orifice A-T initial opening < 0 • Orifice B-T initial opening < 0
2		<p>All four orifices are open (underlapped) in neutral position:</p> <ul style="list-style-type: none"> • Orifice P-A initial opening > 0 • Orifice P-B initial opening > 0 • Orifice A-T initial opening > 0 • Orifice B-T initial opening > 0
3		<p>Orifices P-A and P-B are overlapped. Orifices A-T and B-T are overlapped for more than valve stroke:</p> <ul style="list-style-type: none"> • Orifice P-A initial opening < 0 • Orifice P-B initial opening < 0 • Orifice A-T initial opening < - <i>valve_stroke</i> • Orifice B-T initial opening < - <i>valve_stroke</i>
4		<p>Orifices P-A and P-B are overlapped, while orifices A-T and B-T are open:</p> <ul style="list-style-type: none"> • Orifice P-A initial opening < 0 • Orifice P-B initial opening < 0 • Orifice A-T initial opening > 0 • Orifice B-T initial opening > 0
5		<p>Orifices P-A and A-T are open in neutral position, while orifices P-B and B-T are overlapped:</p> <ul style="list-style-type: none"> • Orifice P-A initial opening > 0 • Orifice P-B initial opening < 0 • Orifice A-T initial opening > 0 • Orifice B-T initial opening < 0
6		<p>Orifice A-T is initially open, while all three remaining orifices are overlapped:</p> <ul style="list-style-type: none"> • Orifice P-A initial opening < 0 • Orifice P-B initial opening < 0 • Orifice A-T initial opening > 0 • Orifice B-T initial opening < 0

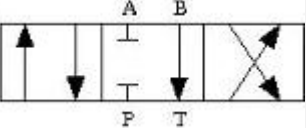
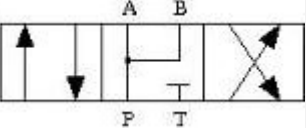
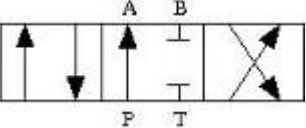
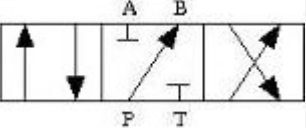
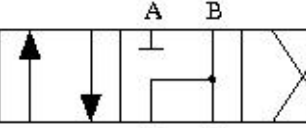
No	Configuration	Initial Openings
7		<p>Orifice B-T is initially open, while all three remaining orifices are overlapped:</p> <ul style="list-style-type: none"> • Orifice P-A initial opening < 0 • Orifice P-B initial opening < 0 • Orifice A-T initial opening < 0 • Orifice B-T initial opening > 0
8		<p>Orifices P-A and P-B are open, while orifices A-T and B-T are overlapped:</p> <ul style="list-style-type: none"> • Orifice P-A initial opening > 0 • Orifice P-B initial opening > 0 • Orifice A-T initial opening < 0 • Orifice B-T initial opening < 0
9		<p>Orifice P-A is initially open, while all three remaining orifices are overlapped:</p> <ul style="list-style-type: none"> • Orifice P-A initial opening > 0 • Orifice P-B initial opening < 0 • Orifice A-T initial opening < 0 • Orifice B-T initial opening < 0
10		<p>Orifice P-B is initially open, while all three remaining orifices are overlapped:</p> <ul style="list-style-type: none"> • Orifice P-A initial opening < 0 • Orifice P-B initial opening > 0 • Orifice A-T initial opening < 0 • Orifice B-T initial opening < 0
11		<p>Orifices P-B and B-T are open, while orifices P-A and A-T are overlapped:</p> <ul style="list-style-type: none"> • Orifice P-A initial opening < 0 • Orifice P-B initial opening > 0 • Orifice A-T initial opening < 0 • Orifice B-T initial opening > 0

Structural Component Diagram

The block is a composite component with four Variable Orifice blocks driven by a single physical signal. Blocks Variable Orifice P-A and Variable Orifice P-B represent the **P-A** and **P-B** flow paths. Blocks Variable orifice A-T and Variable orifice B-T represent the **A-T** and **B-T** flow paths. The physical signal is specified through Connection Port block **S**.

The **Orifice orientation** block parameters are set so that a positive signal acts to open Variable Orifice P-A and Variable Orifice B-T while closing Variable Orifice A-T and Variable Orifice P-B. A negative signal has the opposite effect—acting to open Variable Orifice A-T

and Variable Orifice P-B while closing Variable Orifice P-A and Variable Orifice B-T.

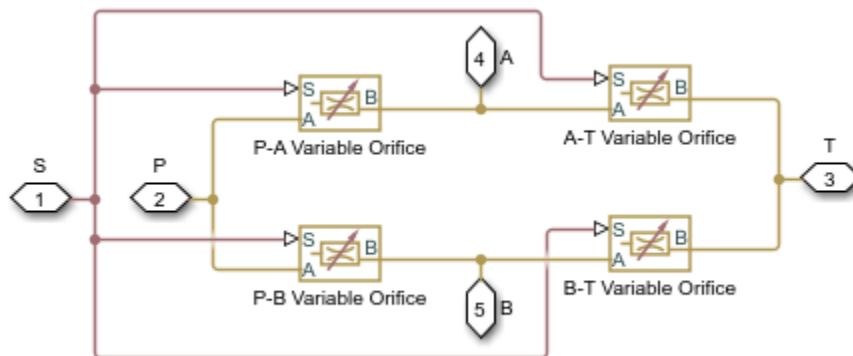

Valve Structural Diagram

Assumptions

- Fluid inertia is ignored.
- Control member loading due to inertial, spring, and other forces is ignored.
- All valve orifices are assumed identical in size unless otherwise specified.

Ports

Input

S – Control member displacement, m
physical signal

Physical signal input port for the control member displacement.

Conserving

P – Pressure supply connection port
hydraulic (isothermal liquid)

Hydraulic (isothermal liquid) conserving port associated with the pressure supply line inlet.

T – Return line connection port
hydraulic (isothermal liquid)

Hydraulic (isothermal liquid) conserving port associated with the return line connection.

A – Actuator connection port
hydraulic (isothermal liquid)

Hydraulic (isothermal liquid) conserving port associated with the actuator connection port.

B – Actuator connection port
hydraulic (isothermal liquid)

Hydraulic (isothermal liquid) conserving port associated with the actuator connection port.

Parameters

Basic Parameters

Area characteristics — Symmetry of the flow path opening characteristics

Identical for all flow paths (default) | Different for each flow path

Choice of different or identical flow path opening characteristics. Select **Different** for each flow path to specify flow path parameters or tabulated data separately for each flow path.

Model parameterization — Types of valve parameters to use as input

Maximum area and opening (default) | Area vs. opening table | Pressure-flow characteristic

Parameterization of the valve model. Options include:

- **By maximum area and opening** — Specify the maximum orifice opening and opening area. The opening area varies linearly with the spool displacement specified at physical signal port **S**.
- **By area vs. opening table** — Specify the flow path opening area at discrete orifice openings as a 1-D lookup table. The opening area is computed by interpolation or extrapolation of the tabulated data.
- **By pressure-flow characteristic** — Specify the flow path volumetric flow rates at discrete orifice openings and pressure differentials. The flow rate is computed by interpolation or extrapolation of the tabulated data.

Interpolation method — Method of computing values inside the lookup table range

Linear (default) | Smooth

Method of computing values inside the tabulated data range. The **Linear** method joins adjacent data points with straight line or surface segments with generally discontinuous slope at the segment boundaries. Surface segments are used in the 2-D lookup table specified in the **Pressure-flow characteristic** model parameterization.



The **Smooth** method replaces the straight segments with curved versions that have continuous slope everywhere inside the tabulated data range. The segments form a smooth line or surface passing through all of the tabulated data points without the discontinuities in first-order derivatives characteristic of the **Linear** interpolation method.

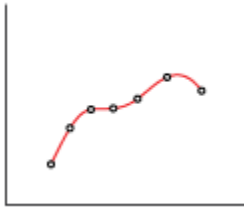

Dependencies

This parameter is active when the **Model Parameterization** parameter is set to By area vs. opening table or Pressure-flow characteristic.

Extrapolation method – Method of computing values outside of the lookup table range

Linear (default) | Nearest

Method of computing values outside of the tabulated data range. The Linear method extends the line segment drawn between the last two data points at each end of the data range outward with a constant slope.

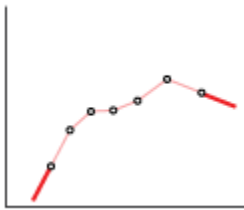

The Nearest method extends the last data point at each end of the data range outward as a horizontal line with constant value.

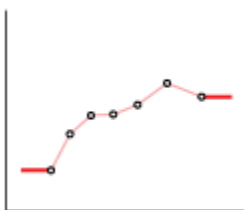

Dependencies

This parameter is active when the **Model Parameterization** parameter is set to By area vs. opening table or Pressure-flow characteristic.

Flow discharge coefficient – Semi-empirical parameter for valve capacity characterization

0.7 (default) | unitless scalar between 0 and 1

Ratio of the actual and theoretical flow rates through the valve. This parameter depends on the geometrical properties of the valve. Values are usually provided in textbooks and manufacturer data sheets.

Dependencies

This parameter is active when the **Model Parameterization** parameter is set to `By maximum area and opening` or `By area vs. opening table`.

Leakage area — Internal leakage area between valve inlets

1e-12 m² (default) | positive scalar in units of area

Total area of internal leaks in the completely closed state. The purpose of this parameter is to maintain the numerical integrity of the fluid network by preventing a portion of that network from becoming isolated when the valve is completely closed.

Dependencies

This parameter is active when the **Model Parameterization** parameter is set to `By maximum area and opening` or `By area vs. opening table`.

Laminar transition specification — Choice of parameter used to define the laminar-turbulent transition

Pressure ratio (default) | Reynolds number

Select the parameter to base the laminar-turbulent transition on. Options include:

- `Pressure ratio` — Flow transitions between laminar and turbulent at the pressure ratio specified in the **Laminar flow pressure ratio** parameter. Use this option for the smoothest and most numerically robust flow transitions.
- `Reynolds number` — The transition occurs at the Reynolds number specified in the **Critical Reynolds number** parameter. Flow transitions are more abrupt and can cause simulation issues at near-zero flow rates.

Dependencies

This parameter is active when the **Model Parameterization** parameter is set to `By maximum area and opening` or `By area vs. opening table`.

Laminar flow pressure ratio — Pressure ratio at the laminar-turbulent flow transition

0.999 (default) | unitless scalar between 0 and 1

Pressure ratio at which the flow transitions between the laminar and turbulent regimes. The pressure ratio is the fraction of the outlet pressure over the inlet pressure.

Dependencies

This parameter is active when the **Model Parameterization** parameter is set to `By maximum area and opening` or `By area vs. opening table` and the **Laminar transition specification** parameter is set to `Pressure ratio`.

Critical Reynolds number — Reynolds number at the laminar-turbulent flow transition

12 (default) | unitless positive scalar

Maximum Reynolds number for laminar flow. This parameter depends on the orifice geometrical profile. You can find recommendations on the parameter value in hydraulics textbooks. The default value, 12, corresponds to a round orifice in thin material with sharp edges.

Dependencies

This parameter is active when the **Model Parameterization** parameter is set to By maximum area and opening or By area vs. opening table and the **Laminar transition specification** parameter is set to Reynolds number.

Model Parameterization: Maximum area and opening**Maximum opening — Orifice opening at which the opening area is a maximum**

0.005 m (default) | positive scalar with units of length

Orifice opening at which the opening area of a flow path is a maximum. The maximum opening is the same for all flow paths when this parameter is exposed. For the orifice opening definitions, see “Orifice Openings” on page 1-109.

Dependencies

This parameter is active when the **Area characteristics** parameter is set to Identical for all flow paths and the **Model parameterization** parameter is set to Maximum area and opening.

Maximum opening area — Maximum cross-sectional area of a flow path

0.5e-4 m² (default) | positive scalar with units of area

Maximum cross-sectional area of a flow path. The maximum opening areas are the same for all paths when this parameter is exposed. For the opening area calculations, see “Opening Areas” on page 1-111.

Dependencies

This parameter is active when the **Area characteristics** parameter is set to Identical for all flow paths and the **Model parameterization** parameter is set to Maximum area and opening.

P-A, maximum opening — P-A orifice opening at which the opening area is a maximum

0.005 m (default) | positive scalar with units of length

Control member position at which the P-A opening area is equal to the **P-A, maximum opening area** parameter value.

Dependencies

This parameter is active when the **Area characteristics** parameter is set to Different for each flow path and the **Model parameterization** parameter is set to Maximum area and opening.

P-A, maximum opening area — Maximum flow area of the P-A flow path

0.5e-4 m² (default) | positive scalar with units of area

Maximum cross-sectional area of the **P-A** flow path. The maximum opening areas are different for each flow path when this parameter is exposed. For the opening area calculations, see “Opening Areas” on page 1-111.

Dependencies

This parameter is active when the **Area characteristics** parameter is set to Different for each flow path and the **Model parameterization** parameter is set to Maximum area and opening.

P-B, maximum opening — P-B Orifice opening at which the opening area is a maximum

0.005 m (default) | positive scalar with units of length

Control member position at which the P-B opening area is equal to the **P-B, maximum opening area** parameter value.

Dependencies

This parameter is active when the **Area characteristics** parameter is set to Different for each flow path and the **Model parameterization** parameter is set to Maximum area and opening.

P-B, maximum opening area — Maximum flow area of the P-B flow path

0.5e-4 m² (default) | positive scalar with units of area

Maximum cross-sectional area of the **P-B** flow path. The maximum opening areas are different for each flow path when this parameter is exposed. For the opening area calculations, see “Opening Areas” on page 1-111.

Dependencies

This parameter is active when the **Area characteristics** parameter is set to Different for each flow path and the **Model parameterization** parameter is set to Maximum area and opening.

A-T, maximum opening — A-T Orifice opening at which the opening area is a maximum

0.005 m (default) | positive scalar with units of length

Control member position at which the A-T opening area is equal to the **A-T, maximum opening area** parameter value.

Dependencies

This parameter is active when the **Area characteristics** parameter is set to Different for each flow path and the **Model parameterization** parameter is set to Maximum area and opening.

A-T, maximum opening area — Maximum flow area of the A-T flow path

0.5e-4 m² (default) | positive scalar with units of area

Maximum cross-sectional area of the **A-T** flow path. The maximum opening areas are different for each flow path when this parameter is exposed. For the opening area calculations, see “Opening Areas” on page 1-111.

Dependencies

This parameter is active when the **Area characteristics** parameter is set to Different for each flow path and the **Model parameterization** parameter is set to Maximum area and opening.

B-T, maximum opening — B-T Orifice opening at which the opening area is a maximum

0.005 m (default) | positive scalar with units of length

Control member position at which the B-T opening area is equal to the **B-T, maximum opening area** parameter value.

Dependencies

This parameter is active when the **Area characteristics** parameter is set to Different for each flow path and the **Model parameterization** parameter is set to Maximum area and opening.

B-T, maximum opening area — Maximum flow area of the B-T flow path

0.5e-4 m² (default) | positive scalar with units of area

Maximum cross-sectional area of the **B-T** flow path. The maximum opening areas are different for each flow path when this parameter is exposed. For the opening area calculations, see “Opening Areas” on page 1-111.

Dependencies

This parameter is active when the **Area characteristics** parameter is set to **Different** for each flow path and the **Model parameterization** parameter is set to **Maximum area and opening**.

Model Parameterization: Area vs. opening table

Opening vector – Orifice openings at which to specify the flow path opening areas
 [-0.002, 0.0, 0.002, 0.005, 0.015] m (default) | numerical array with units of length

Array of orifice openings used to construct the opening area 1-D lookup table for all flow paths. The opening characteristics are identical for all flow paths when this parameter is exposed. The number of elements in the array determines the number of elements in the table.

The array must increase from left to right but the intervals between the array element values need not be uniform. There must be at least two elements for **Linear** interpolation and three elements for **Smooth** interpolation.

Dependencies

This parameter is active when the **Area characteristics** parameter is set to **Identical** for all flow paths and the **Model parameterization** parameter is set to **Area vs. opening table**.

Opening area vector – Opening areas corresponding to the orifice openings specified in the Opening vector parameter
 [1.0e-9, 2.0352e-7, 4.0736e-5, 0.00011438, 0.00034356] m² (default) | numerical array with units of area

Array of flow path opening areas corresponding to the specified orifice openings. The opening characteristics are identical for all flow paths when this parameter is exposed. The number of elements in the array must match the number of elements in the **Opening vector** parameter.

Dependencies

This parameter is active when the **Area characteristics** parameter is set to **Identical** for all flow paths and the **Model parameterization** parameter is set to **Area vs. opening table**.

P-A, opening vector – P-A orifice openings at which to specify the P-A opening area
 [-0.002, 0.0, 0.002, 0.005, 0.015] m (default) | numerical array with units of length

Array of **P-A** orifice openings used to construct the opening area 1-D lookup table for the **P-A** flow path. The number of elements in the array determines the number of elements in the table.

The array must increase from left to right but the intervals between the array element values need not be uniform. There must be at least two elements for **Linear** interpolation and three elements for **Smooth** interpolation.

Dependencies

This parameter is active when the **Area characteristics** parameter is set to **Different** for each flow path and the **Model parameterization** parameter is set to **Area vs. opening table**.

P-A, opening area vector — P-A opening areas corresponding to the orifice openings specified in the P-A, opening vector parameter

[1.0e-9, 2.0352e-7, 4.0736e-5, 0.00011438, 0.00034356] m² (default) | numerical array with units of area

Array of **P-A** opening areas corresponding to the specified **P-A** orifice openings. The number of elements in the array must match the number of elements in the **P-A, opening vector** parameter.

Dependencies

This parameter is active when the **Area characteristics** parameter is set to **Different** for each flow path and the **Model parameterization** parameter is set to **Area vs. opening table**.

P-B, opening vector — P-B orifice openings at which to specify the P-B opening area

[-0.002, 0.0, 0.002, 0.005, 0.015] m (default) | numerical array with units of length

Array of **P-B** orifice openings used to construct the opening area 1-D lookup table for the **P-B** flow path. The number of elements in the array determines the number of elements in the table.

The array must increase from left to right but the intervals between the array element values need not be uniform. There must be at least two elements for **Linear** interpolation and three elements for **Smooth** interpolation.

Dependencies

This parameter is active when the **Area characteristics** parameter is set to **Different** for each flow path and the **Model parameterization** parameter is set to **Area vs. opening table**.

P-B, opening area vector — P-B opening areas corresponding to the orifice openings specified in the P-B, opening vector parameter

[1.0e-9, 2.0352e-7, 4.0736e-5, 0.00011438, 0.00034356] m² (default) | numerical array with units of area

Array of **P-B** opening areas corresponding to the specified **P-B** orifice openings. The number of elements in the array must match the number of elements in the **P-B, opening vector** parameter.

Dependencies

This parameter is active when the **Area characteristics** parameter is set to **Different** for each flow path and the **Model parameterization** parameter is set to **Area vs. opening table**.

A-T, opening vector — A-T orifice openings at which to specify the A-T opening area

[-0.002, 0.0, 0.002, 0.005, 0.015] m (default) | numerical array with units of length

Array of **A-T** orifice openings used to construct the opening area 1-D lookup table for the **A-T** flow path. The number of elements in the array determines the number of elements in the table.

The array must increase from left to right but the intervals between the array element values need not be uniform. There must be at least two elements for **Linear** interpolation and three elements for **Smooth** interpolation.

Dependencies

This parameter is active when the **Area characteristics** parameter is set to **Different** for each flow path and the **Model parameterization** parameter is set to **Area vs. opening table**.

A-T, opening area vector — A-T opening areas corresponding to the orifice openings specified in the A-T, opening vector parameter

[1.0e-9, 2.0352e-7, 4.0736e-5, 0.00011438, 0.00034356] m² (default) | numerical array with units of area

Array of **A-T** opening areas corresponding to the specified **A-T** orifice openings. The number of elements in the array must match the number of elements in the **A-T, opening vector** parameter.

Dependencies

This parameter is active when the **Area characteristics** parameter is set to Different for each flow path and the **Model parameterization** parameter is set to Area vs. opening table.

B-T, opening vector — B-T orifice openings at which to specify the B-T opening area

[-0.002, 0.0, 0.002, 0.005, 0.015] m (default) | numerical array with units of length

Array of **B-T** orifice openings used to construct the opening area 1-D lookup table for the **B-T** flow path. The number of elements in the array determines the number of elements in the table.

The array must increase from left to right but the intervals between the array element values need not be uniform. There must be at least two elements for Linear interpolation and three elements for Smooth interpolation.

Dependencies

This parameter is active when the **Area characteristics** parameter is set to Different for each flow path and the **Model parameterization** parameter is set to Area vs. opening table.

B-T, opening area vector — B-T opening areas corresponding to the orifice openings specified in the B-T, opening vector parameter

[1.0e-9, 2.0352e-7, 4.0736e-5, 0.00011438, 0.00034356] m² (default) | numerical array with units of area

Array of **B-T** opening areas corresponding to the specified **B-T** orifice openings. The number of elements in the array must match the number of elements in the **B-T, opening vector** parameter.

Dependencies

This parameter is active when the **Area characteristics** parameter is set to Different for each flow path and the **Model parameterization** parameter is set to Area vs. opening table.

Model Parameterization: Pressure-flow characteristic**Opening vector, s — Orifice openings at which to specify the flow rate tabulated data**

[-0.002, 0.0, 0.002, 0.005, 0.015] m (default) | numerical array with units of length

Array of orifice openings used to construct the volumetric flow rate 2-D lookup table. The number of elements in the array determines the number of rows in the table. The array must increase from left to right but the intervals between the array element values need not be uniform. There must be at least two elements for Linear interpolation and three elements for Smooth interpolation.

Dependencies

This parameter is active when the **Area characteristics** parameter is set to Identical for all flow paths and the **Model parameterization** parameter is set to Pressure-flow characteristic.

Pressure differential vector, dp – Pressure differentials at which to specify the flow rate data

[-10000000.0, -5000000.0, -2000000.0, 2000000.0, 5000000.0, 10000000.0] Pa (default) | numerical array with units of pressure

Array of pressure differentials used to construct the volumetric flow rate 2-D lookup table. The number of elements in the array determines the number of columns in the table. The array must increase from left to right but the intervals between the array element values need not be uniform. There must be at least two elements for Linear interpolation and three elements for Smooth interpolation.

Dependencies

This parameter is active when the **Area characteristics** parameter is set to Identical for all flow paths and the **Model parameterization** parameter is set to Pressure-flow characteristic.

Volumetric flow rate table, q(s,dp) – Volumetric flow rates at the specified control member displacements and pressure differentials

5-by-6 matrix with elements between -0.0344 and 0.0344 m³/s (default) | numerical array with units of length

Matrix with the volumetric flow rates corresponding to the specified orifice openings and pressure differentials. The number of rows must match the number of elements in the **Opening vector, s** parameter. The number of columns must match the number of elements in the **Pressure differential vector, dp** parameter.

Dependencies

This parameter is active when the **Area characteristics** parameter is set to Identical for all flow paths and the **Model parameterization** parameter is set to Pressure-flow characteristic.

P-A, opening vector, s – Orifice openings at which to specify the P-A flow rate data

[-0.002, 0.0, 0.002, 0.005, 0.015] m (default) | numerical array with units of length

Array of P-A orifice openings used to construct the P-A volumetric flow rate 2-D lookup table. The number of elements in the array determines the number of rows in the table. The array must increase from left to right but the intervals between the array element values need not be uniform. There must be at least two elements for Linear interpolation and three elements for Smooth interpolation.

Dependencies

This parameter is active when the **Area characteristics** parameter is set to Different for each flow path and the **Model parameterization** parameter is set to Pressure-flow characteristic.

P-A, pressure differential vector, dp – Pressure differentials at which to specify the flow rate data for the P-A flow path

[-10000000.0, -5000000.0, -2000000.0, 2000000.0, 5000000.0, 10000000.0] Pa (default) | numerical array with units of pressure

Array of pressure differentials used to construct the volumetric flow rate 2-D lookup table for the P-A flow path. The number of elements in the array determines the number of columns in the table.

The array must increase from left to right but the intervals between the array element values need not be uniform. There must be at least two elements for Linear interpolation and three elements for Smooth interpolation.

Dependencies

This parameter is active when the **Area characteristics** parameter is set to Different for each flow path and the **Model parameterization** parameter is set to Pressure-flow characteristic.

P-A, volumetric flow rate table, $q(s, dp)$ – Volumetric flow rates at the specified control member displacements and pressure differentials for the P-A flow path

5-by-6 matrix with elements between -0.0344 and 0.0344 m³/s (default) | numerical array with units of length

Matrix with the volumetric flow rates through the P-A flow path at the specified control member displacements and pressure differentials. The number of rows must match the number of elements in the **P-A, opening vector, s** parameter. The number of columns must match the number of elements in the **P-A, pressure differential vector, dp** parameter.

Dependencies

This parameter is active when the **Area characteristics** parameter is set to Different for each flow path and the **Model parameterization** parameter is set to Pressure-flow characteristic.

P-B, opening vector, s – Control member displacements at which to specify the flow rate data for the P-B flow path

$[-0.002, 0.0, 0.002, 0.005, 0.015]$ m (default) | numerical array with units of length

Array of control member displacements used to construct the volumetric flow rate 2-D lookup table for the P-B flow path. The number of elements in the array determines the number of rows in the table.

The array must increase from left to right but the intervals between the array element values need not be uniform. There must be at least two elements for Linear interpolation and three elements for Smooth interpolation.

Dependencies

This parameter is active when the **Area characteristics** parameter is set to Different for each flow path and the **Model parameterization** parameter is set to Pressure-flow characteristic.

P-B, pressure differential vector, dp – Pressure differentials at which to specify the flow rate data for the P-B flow path

$[-10000000.0, -5000000.0, -2000000.0, 2000000.0, 5000000.0, 10000000.0]$ Pa (default) | numerical array with units of pressure

Array of pressure differentials used to construct the volumetric flow rate 2-D lookup table for the P-B flow path. The number of elements in the array determines the number of columns in the table.

The array must increase from left to right but the intervals between the array element values need not be uniform. There must be at least two elements for Linear interpolation and three elements for Smooth interpolation.

Dependencies

This parameter is active when the **Area characteristics** parameter is set to `Different` for each flow path and the **Model parameterization** parameter is set to `Pressure-flow` characteristic.

P-B, volumetric flow rate table, $q(s,dp)$ — Volumetric flow rates at the specified control member displacements and pressure differentials for the P-B flow path

5-by-6 matrix with elements between -0.0344 and 0.0344 m³/s (default) | numerical array with units of length

Matrix with the volumetric flow rates through the P-B flow path at the specified control member displacements and pressure differentials. The number of rows must match the number of elements in the **P-B, opening vector, s** parameter. The number of columns must match the number of elements in the **P-A, pressure differential vector, dp** parameter.

Dependencies

This parameter is active when the **Area characteristics** parameter is set to `Different` for each flow path and the **Model parameterization** parameter is set to `Pressure-flow` characteristic.

A-T, opening vector, s — Control member displacements at which to specify the flow rate data for the A-T flow path

`[-0.002, 0.0, 0.002, 0.005, 0.015]` m (default) | numerical array with units of length

Array of control member displacements used to construct the volumetric flow rate 2-D lookup table for the A-T flow path. The number of elements in the array determines the number of rows in the table.

The array must increase from left to right but the intervals between the array element values need not be uniform. There must be at least two elements for `Linear` interpolation and three elements for `Smooth` interpolation.

Dependencies

This parameter is active when the **Area characteristics** parameter is set to `Different` for each flow path and the **Model parameterization** parameter is set to `Pressure-flow` characteristic.

A-T, pressure differential vector, dp — Pressure differentials at which to specify the flow rate data for the A-T flow path

`[-10000000.0, -5000000.0, -2000000.0, 2000000.0, 5000000.0, 10000000.0]` Pa (default) | numerical array with units of pressure

Array of pressure differentials used to construct the volumetric flow rate 2-D lookup table for the A-T flow path. The number of elements in the array determines the number of columns in the table.

The array must increase from left to right but the intervals between the array element values need not be uniform. There must be at least two elements for `Linear` interpolation and three elements for `Smooth` interpolation.

Dependencies

This parameter is active when the **Area characteristics** parameter is set to **Different** for each flow path and the **Model parameterization** parameter is set to **Pressure-flow** characteristic.

A-T, volumetric flow rate table, $q(s, dp)$ — Volumetric flow rates at the specified control member displacements and pressure differentials for the A-T flow path

5-by-6 matrix with elements between -0.0344 and 0.0344 m³/s (default) | numerical array with units of length

Matrix with the volumetric flow rates through the A-T flow path at the specified control member displacements and pressure differentials. The number of rows must match the number of elements in the **A-T, opening vector, s** parameter. The number of columns must match the number of elements in the **A-T, pressure differential vector, dp** parameter.

Dependencies

This parameter is active when the **Area characteristics** parameter is set to **Different** for each flow path and the **Model parameterization** parameter is set to **Pressure-flow** characteristic.

B-T, opening vector, s — Control member displacements at which to specify the flow rate data for the B-T flow path

$[-0.002, 0.0, 0.002, 0.005, 0.015]$ m (default) | numerical array with units of length

Array of control member displacements used to construct the volumetric flow rate 2-D lookup table for the B-T flow path. The number of elements in the array determines the number of rows in the table.

The array must increase from left to right but the intervals between the array element values need not be uniform. There must be at least two elements for **Linear** interpolation and three elements for **Smooth** interpolation.

Dependencies

This parameter is active when the **Area characteristics** parameter is set to **Different** for each flow path and the **Model parameterization** parameter is set to **Pressure-flow** characteristic.

B-T, pressure differential vector, dp — Pressure differentials at which to specify the flow rate data for the B-T flow path

$[-10000000.0, -5000000.0, -2000000.0, 2000000.0, 5000000.0, 10000000.0]$ Pa (default) | numerical array with units of pressure

Array of pressure differentials used to construct the volumetric flow rate 2-D lookup table for the B-T flow path. The number of elements in the array determines the number of columns in the table.

The array must increase from left to right but the intervals between the array element values need not be uniform. There must be at least two elements for **Linear** interpolation and three elements for **Smooth** interpolation.

Dependencies

This parameter is active when the **Area characteristics** parameter is set to `Different` for each flow path and the **Model parameterization** parameter is set to `Pressure-flow characteristic`.

B-T, volumetric flow rate table, $q(s,dp)$ — Volumetric flow rates at the specified control member displacements and pressure differentials for the B-T flow path

5-by-6 matrix with elements between -0.0344 and 0.0344 m³/s (default) | numerical array with units of length

Matrix with the volumetric flow rates through the B-T flow path at the specified control member displacements and pressure differentials. The number of rows must match the number of elements in the **B-T, opening vector, s** parameter. The number of columns must match the number of elements in the **B-T, pressure differential vector, dp** parameter.

Dependencies

This parameter is active when the **Area characteristics** parameter is set to `Different` for each flow path and the **Model parameterization** parameter is set to `Pressure-flow characteristic`.

Valve Opening Offsets

Between P-A — P-A orifice opening at zero spool displacement

0 m (default) | scalar number with units of lengths

Orifice opening of the **P-A** flow path at zero spool displacement. Specify a positive offset to model an underlapped valve or a negative offset to model an overlapped valve. The default value of 0 corresponds to a zero-lapped valve.

Between P-B — P-B orifice opening at zero spool displacement

0 m (default) | scalar number with units of lengths

Orifice opening of the **P-B** flow path at zero spool displacement. Specify a positive offset to model an underlapped valve or a negative offset to model an overlapped valve. The default value of 0 corresponds to a zero-lapped valve.

Between A-T — A-T orifice opening at zero spool displacement

0 m (default) | scalar number with units of length

Orifice opening of the **A-T** flow path at zero spool displacement. Specify a positive offset to model an underlapped valve or a negative offset to model an overlapped valve. The default value of 0 corresponds to a zero-lapped valve.

Between B-T — BT orifice opening at zero spool displacement

0 m (default) | scalar number with units of length

Orifice opening of the **P-B** flow path at zero spool displacement. Specify a positive offset to model an underlapped valve or a negative offset to model an overlapped valve. The default value of 0 corresponds to a zero-lapped valve.

Extended Capabilities

C/C++ Code Generation

Generate C and C++ code using Simulink® Coder™.

See Also

2-Way Directional Valve | 3-Way Directional Valve

Topics

“Upgrading Simscape Fluids Models Containing Hydraulics (Isothermal) Blocks”

4-Way Directional Valve A

Configuration A of hydraulic continuous 4-way directional valve



Library

Directional Valves

Description

The 4-Way Directional Valve A block simulates a configuration of hydraulic continuous 4-way directional valve where the valve unloads the pump in neutral position. The fluid is pumped in the valve through the inlet line P and is distributed between two outside hydraulic lines A and B (usually connected to a double-acting actuator) and the return line T. The block has four hydraulic connections, corresponding to inlet port (P), actuator ports (A and B), and return port (T), and one physical signal port connection (S), which controls the spool position. The block is built of six Variable Orifice blocks, connected as shown in the following diagram.

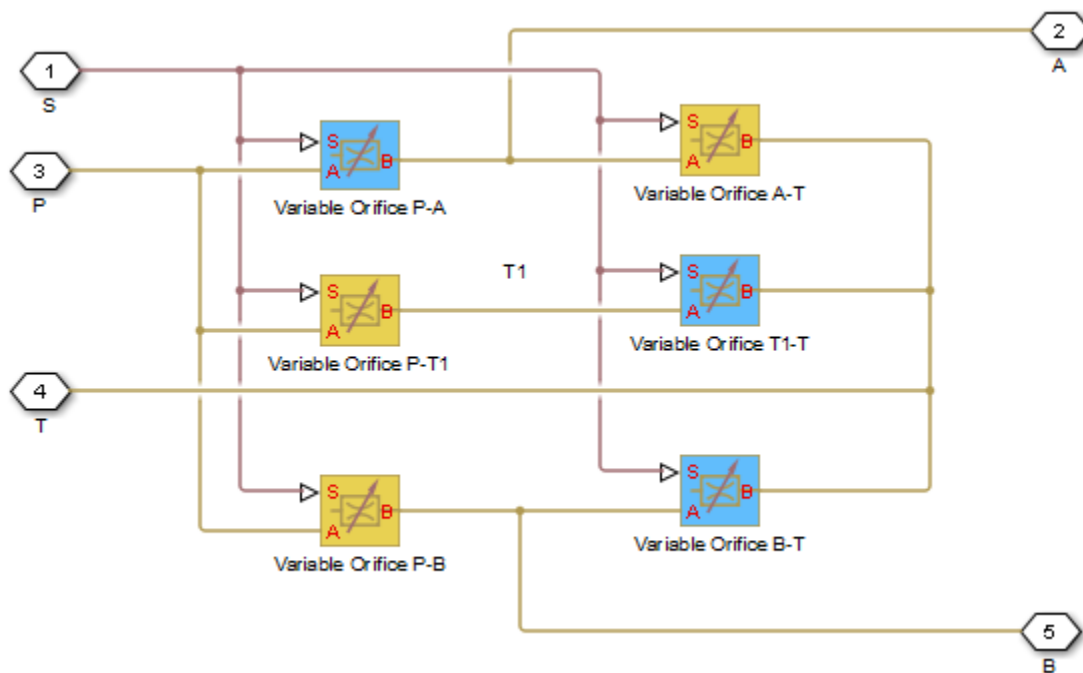

All blocks are controlled by the same position signal, provided through the physical signal port S, but the **Orifice orientation** parameter in the block instances is set in such a way that positive signal at

port S opens the orifices colored blue in the block diagram (orifices P-A, B-T, and T1-T) and closes the orifices colored yellow (orifices A-T, P-B, and P-T1). As a result, the openings of the orifices are computed as follows:

$$h_{PA} = h_{PA0} + x$$

$$h_{PB} = h_{PB0} - x$$

$$h_{AT} = h_{AT0} - x$$

$$h_{BT} = h_{BT0} + x$$

$$h_{PT1} = h_{PT10} - x$$

$$h_{T1T} = h_{T1T0} + x$$

where

h_{PA}	Orifice opening for the Variable Orifice P-A block
h_{PB}	Orifice opening for the Variable Orifice P-B block
h_{AT}	Orifice opening for the Variable Orifice A-T block
h_{BT}	Orifice opening for the Variable Orifice B-T block
h_{PT1}	Orifice opening for the Variable Orifice P-T1 block
h_{T1T}	Orifice opening for the Variable Orifice T1-T block
h_{PA0}	Initial opening for the Variable Orifice P-A block
h_{PB0}	Initial opening for the Variable Orifice P-B block
h_{AT0}	Initial opening for the Variable Orifice A-T block
h_{BT0}	Initial opening for the Variable Orifice B-T block
h_{PT10}	Initial opening for the Variable Orifice P-T1 block
h_{T1T0}	Initial opening for the Variable Orifice T1-T block
x	Control member displacement from initial position

For information on the block parameterization options, basic parameter descriptions, assumptions and limitations, global and restricted parameters, see the 4-Way Directional Valve block reference page.

Parameters

- “Basic Parameters Tab” on page 1-131
- “Valve Opening Offsets Tab” on page 1-134

Basic Parameters Tab

Model parameterization

Select one of the following methods for specifying the valve:

- By maximum area and opening — Provide values for the maximum valve passage area and the maximum valve opening. The passage area is linearly dependent on the control member

displacement, that is, the valve is closed at the initial position of the control member (zero displacement), and the maximum opening takes place at the maximum displacement. This is the default method.

- **By area vs. opening table** — Provide tabulated data of valve openings and corresponding valve passage areas. The passage area is determined by one-dimensional table lookup. You have a choice of two interpolation methods and two extrapolation methods.
- **By pressure-flow characteristic** — Provide tabulated data of valve openings, pressure differentials, and corresponding flow rates. The flow rate is determined by two-dimensional table lookup. You have a choice of two interpolation methods and two extrapolation methods.

Valve passage maximum area

Specify the area of a fully opened valve. The parameter value must be greater than zero. The default value is $5e-5 \text{ m}^2$. This parameter is used if **Model parameterization** is set to **By maximum area and opening**.

Valve maximum opening

Specify the maximum displacement of the control member. The parameter value must be greater than zero. The default value is $5e-3 \text{ m}$. This parameter is used if **Model parameterization** is set to **By maximum area and opening**.

Valve opening vector, **s**

Specify the vector of input values for valve openings as a one-dimensional array. The input values vector must be strictly increasing. The values can be nonuniformly spaced. The minimum number of values depends on the interpolation method: you must provide at least two values for linear interpolation, at least three values for smooth interpolation. The default values, in meters, are $[-0.002 \ 0 \ 0.002 \ 0.005 \ 0.015]$. If **Model parameterization** is set to **By area vs. opening table**, the **Tabulated valve openings** values will be used together with **Tabulated valve passage area** values for one-dimensional table lookup. If **Model parameterization** is set to **By pressure-flow characteristic**, the **Tabulated valve openings** values will be used together with **Tabulated pressure differentials** and **Tabulated flow rates** for two-dimensional table lookup.

Valve passage area vector

Specify the vector of output values for valve passage area as a one-dimensional array. The valve passage area vector must be of the same size as the valve openings vector. All the values must be positive. The default values, in m^2 , are $[1e-09 \ 2.0352e-07 \ 4.0736e-05 \ 0.00011438 \ 0.00034356]$. This parameter is used if **Model parameterization** is set to **By area vs. opening table**.

Pressure differential vector, **dp**

Specify the vector of input values for pressure differentials as a one-dimensional array. The vector must be strictly increasing. The values can be nonuniformly spaced. The minimum number of values depends on the interpolation method: you must provide at least two values for linear interpolation, at least three values for smooth interpolation. The default values, in Pa, are $[-1e+07 \ -5e+06 \ -2e+06 \ 2e+06 \ 5e+06 \ 1e+07]$. This parameter is used if **Model parameterization** is set to **By pressure-flow characteristic**.

Volumetric flow rate table, **q(s,dp)**

Specify the flow rates as an m -by- n matrix, where m is the number of valve openings and n is the number of pressure differentials. Each value in the matrix specifies flow rate taking place at a specific combination of valve opening and pressure differential. The matrix size must match the dimensions defined by the input vectors. The default values, in m^3/s , are:

```
[-1e-07 -7.0711e-08 -4.4721e-08 4.4721e-08 7.0711e-08 1e-07;
-2.0352e-05 -1.4391e-05 -9.1017e-06 9.1017e-06 1.4391e-05 2.0352e-05;
```

```
-0.0040736 -0.0028805 -0.0018218 0.0018218 0.0028805 0.0040736;
-0.011438 -0.0080879 -0.0051152 0.0051152 0.0080879 0.011438;
-0.034356 -0.024293 -0.015364 0.015364 0.024293 0.034356;]
```

This parameter is used if **Model parameterization** is set to By pressure-flow characteristic.

Interpolation method

Select one of the following interpolation methods for approximating the output value when the input value is between two consecutive grid points:

- **Linear** — Select this option to get the best performance.
- **Smooth** — Select this option to produce a continuous curve (By area vs. opening table) or surface (By pressure-flow characteristic) with continuous first-order derivatives.

For more information on interpolation algorithms, see the PS Lookup Table (1D) and PS Lookup Table (2D) block reference pages.

Extrapolation method

Select one of the following extrapolation methods for determining the output value when the input value is outside the range specified in the argument list:

- **Linear** — Select this option to produce a curve or surface with continuous first-order derivatives in the extrapolation region and at the boundary with the interpolation region.
- **Nearest** — Select this option to produce an extrapolation that does not go above the highest point in the data or below the lowest point in the data.

For more information on extrapolation algorithms, see the PS Lookup Table (1D) and PS Lookup Table (2D) block reference pages.

Flow discharge coefficient

Semi-empirical parameter for valve capacity characterization. Its value depends on the geometrical properties of the valve, and usually is provided in textbooks or manufacturer data sheets. The default value is 0.7.

Laminar transition specification

Select how the block transitions between the laminar and turbulent regimes:

- **Pressure ratio** — The transition from laminar to turbulent regime is smooth and depends on the value of the **Laminar flow pressure ratio** parameter. This method provides better simulation robustness.
- **Reynolds number** — The transition from laminar to turbulent regime is assumed to take place when the Reynolds number reaches the value specified by the **Critical Reynolds number** parameter.

Laminar flow pressure ratio

Pressure ratio at which the flow transitions between laminar and turbulent regimes. The default value is 0.999. This parameter is visible only if the **Laminar transition specification** parameter is set to **Pressure ratio**.

Critical Reynolds number

The maximum Reynolds number for laminar flow. The value of the parameter depends on the orifice geometrical profile. You can find recommendations on the parameter value in hydraulics textbooks. The default value is 12, which corresponds to a round orifice in thin material with sharp edges. This parameter is visible only if the **Laminar transition specification** parameter is set to **Reynolds number**.

Leakage area

The total area of possible leaks in the completely closed valve. The main purpose of the parameter is to maintain numerical integrity of the circuit by preventing a portion of the system from getting isolated after the valve is completely closed. The parameter value must be greater than 0. The default value is $1e-12 \text{ m}^2$.

Valve Opening Offsets Tab**Between ports P and A**

Orifice opening of the **P-A** flow path at zero spool displacement. Specify a positive offset to model an underlapped valve or a negative offset to model an overlapped valve. The default value of θ corresponds to a zero-lapped valve. The default value is $-2.5e-3 \text{ m}$.

Between ports P and B

Orifice opening of the **P-B** flow path at zero spool displacement. Specify a positive offset to model an underlapped valve or a negative offset to model an overlapped valve. The default value of θ corresponds to a zero-lapped valve. The default value is $-2.5e-3 \text{ m}$.

Between ports A and T

Orifice opening of the **A-T** flow path at zero spool displacement. Specify a positive offset to model an underlapped valve or a negative offset to model an overlapped valve. The default value of θ corresponds to a zero-lapped valve. The default value is $-2.5e-3 \text{ m}$.

Between ports B and T

Orifice opening of the **B-T** flow path at zero spool displacement. Specify a positive offset to model an underlapped valve or a negative offset to model an overlapped valve. The default value of θ corresponds to a zero-lapped valve. The default value is $-2.5e-3 \text{ m}$.

Between ports P and T1

Orifice opening of the **P-T1** flow path at zero spool displacement. Specify a positive offset to model an underlapped valve or a negative offset to model an overlapped valve. The default value of θ corresponds to a zero-lapped valve. The default value is $2.5e-3 \text{ m}$.

Between ports T1 and T

Orifice opening of the **T1-T** flow path at zero spool displacement. Specify a positive offset to model an underlapped valve or a negative offset to model an overlapped valve. The default value of θ corresponds to a zero-lapped valve. The default value is $2.5e-3 \text{ m}$.

Ports

The block has the following ports:

P

Hydraulic conserving port associated with the pressure supply line inlet.

T

Hydraulic conserving port associated with the return line connection.

A

Hydraulic conserving port associated with the actuator connection port.

B

Hydraulic conserving port associated with the actuator connection port.

S

Physical signal port to control spool displacement.

Extended Capabilities

C/C++ Code Generation

Generate C and C++ code using Simulink® Coder™.

See Also

4-Way Directional Valve | 4-Way Directional Valve B | 4-Way Directional Valve C | 4-Way Directional Valve D | 4-Way Directional Valve E | 4-Way Directional Valve F | 4-Way Directional Valve G | 4-Way Directional Valve H | 4-Way Directional Valve K | 6-Way Directional Valve A

Topics

“Upgrading Simscape Fluids Models Containing Hydraulics (Isothermal) Blocks”

Introduced in R2009b

4-Way Directional Valve B

Configuration B of hydraulic continuous 4-way directional valve



Library

Directional Valves

Description

The 4-Way Directional Valve B block simulates a configuration of hydraulic continuous 4-way directional valve where port A is permanently connected to port P, and all four ports are interconnected in neutral position. The fluid is pumped in the valve through the inlet line P and is distributed between two outside hydraulic lines A and B (usually connected to a double-acting actuator) and the return line T. The block has four hydraulic connections, corresponding to inlet port (P), actuator ports (A and B), and return port (T), and one physical signal port connection (S), which controls the spool position. The block is built of a Fixed Orifice block in the P-A path and four Variable Orifice blocks, connected as shown in the following diagram.

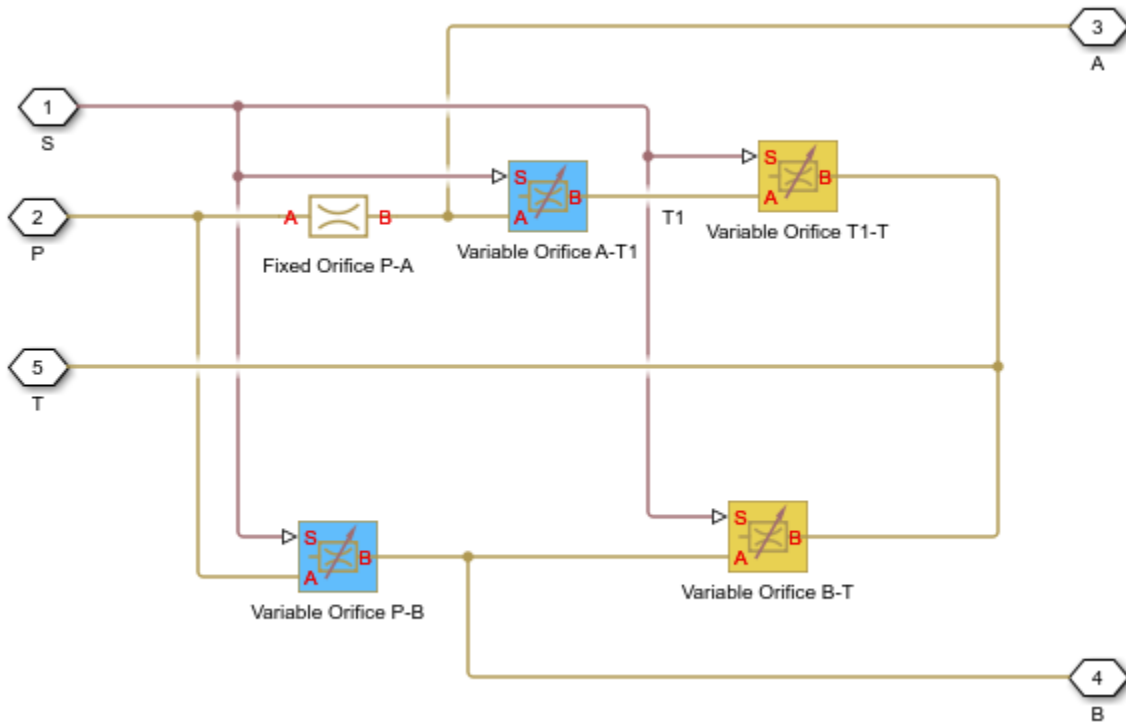

All Variable Orifice blocks are controlled by the same position signal, provided through the physical signal port S, but the **Orifice orientation** parameter in the block instances is set in such a way that positive signal at port S opens the orifices colored blue in the block diagram (orifices A-T1 and P-B) and closes the orifices colored yellow (orifices T1-T and B-T). As a result, the openings of the orifices are computed as follows:

$$h_{AT1} = h_{AT10} - x$$

$$h_{PB} = h_{PB0} - x$$

$$h_{T1T} = h_{T1T0} + x$$

$$h_{BT} = h_{BT0} + x$$

where

h_{AT1}	Orifice opening for the Variable Orifice A-T1 block
h_{PB}	Orifice opening for the Variable Orifice P-B block
h_{T1T}	Orifice opening for the Variable Orifice T1-T block
h_{BT}	Orifice opening for the Variable Orifice B-T block
h_{AT10}	Initial opening for the Variable Orifice A-T1 block
h_{PB0}	Initial opening for the Variable Orifice P-B block
h_{T1T0}	Initial opening for the Variable Orifice T1-T block
h_{BT0}	Initial opening for the Variable Orifice B-T block
x	Control member displacement from initial position

For information on the block parameterization options, basic parameter descriptions, assumptions and limitations, global and restricted parameters, see the 4-Way Directional Valve block reference page.

Parameters

- “Basic Parameters Tab” on page 1-137
- “Valve Opening Offsets Tab” on page 1-140

Basic Parameters Tab

Compared to the Basic Parameters tab of the 4-Way Directional Valve block, there is one additional parameter:

Path P-A passage area

Specify the area of the P-A passage. The parameter value must be greater than zero. The default value is $5e-5 \text{ m}^2$. This parameter is used if **Model parameterization** is set to **By maximum area and opening**.

The rest of the parameters on this tab are identical to those of the 4-Way Directional Valve block:

Model parameterization

Select one of the following methods for specifying the valve:

- **By maximum area and opening** — Provide values for the maximum valve passage area and the maximum valve opening. The passage area is linearly dependent on the control member displacement, that is, the valve is closed at the initial position of the control member (zero displacement), and the maximum opening takes place at the maximum displacement. This is the default method.
- **By area vs. opening table** — Provide tabulated data of valve openings and corresponding valve passage areas. The passage area is determined by one-dimensional table lookup. You have a choice of two interpolation methods and two extrapolation methods.
- **By pressure-flow characteristic** — Provide tabulated data of valve openings, pressure differentials, and corresponding flow rates. The flow rate is determined by two-dimensional table lookup. You have a choice of two interpolation methods and two extrapolation methods.

Valve passage maximum area

Specify the area of a fully opened valve. The parameter value must be greater than zero. The default value is $5e-5 \text{ m}^2$. This parameter is used if **Model parameterization** is set to **By maximum area and opening**.

Valve maximum opening

Specify the maximum displacement of the control member. The parameter value must be greater than zero. The default value is $5e-3 \text{ m}$. This parameter is used if **Model parameterization** is set to **By maximum area and opening**.

Valve opening vector, s

Specify the vector of input values for valve openings as a one-dimensional array. The input values vector must be strictly increasing. The values can be nonuniformly spaced. The minimum number of values depends on the interpolation method: you must provide at least two values for linear interpolation, at least three values for smooth interpolation. The default values, in meters, are $[-0.002 \ 0 \ 0.002 \ 0.005 \ 0.015]$. If **Model parameterization** is set to **By area vs. opening table**, the **Tabulated valve openings** values will be used together with **Tabulated valve passage area** values for one-dimensional table lookup. If **Model parameterization** is set to **By pressure-flow characteristic**, the **Tabulated valve openings** values will be used together with **Tabulated pressure differentials** and **Tabulated flow rates** for two-dimensional table lookup.

Valve passage area vector

Specify the vector of output values for valve passage area as a one-dimensional array. The valve passage area vector must be of the same size as the valve openings vector. All the values must be positive. The default values, in m^2 , are $[1e-09 \ 2.0352e-07 \ 4.0736e-05 \ 0.00011438 \ 0.00034356]$. This parameter is used if **Model parameterization** is set to **By area vs. opening table**.

Pressure differential vector, dp

Specify the vector of input values for pressure differentials as a one-dimensional array. The vector must be strictly increasing. The values can be nonuniformly spaced. The minimum number of values depends on the interpolation method: you must provide at least two values for linear interpolation, at least three values for smooth interpolation. The default values, in Pa, are $[-1e+07 \ -5e+06 \ -2e+06 \ 2e+06 \ 5e+06 \ 1e+07]$. This parameter is used if **Model parameterization** is set to **By pressure-flow characteristic**.

Volumetric flow rate table, q(s,dp)

Specify the flow rates as an m -by- n matrix, where m is the number of valve openings and n is the number of pressure differentials. Each value in the matrix specifies flow rate taking place at a specific combination of valve opening and pressure differential. The matrix size must match the dimensions defined by the input vectors. The default values, in m^3/s , are:

```
[-1e-07 -7.0711e-08 -4.4721e-08 4.4721e-08 7.0711e-08 1e-07;
-2.0352e-05 -1.4391e-05 -9.1017e-06 9.1017e-06 1.4391e-05 2.0352e-05;
-0.0040736 -0.0028805 -0.0018218 0.0018218 0.0028805 0.0040736;
-0.011438 -0.0080879 -0.0051152 0.0051152 0.0080879 0.011438;
-0.034356 -0.024293 -0.015364 0.015364 0.024293 0.034356;]
```

This parameter is used if **Model parameterization** is set to By pressure-flow characteristic.

Interpolation method

Select one of the following interpolation methods for approximating the output value when the input value is between two consecutive grid points:

- **Linear** — Select this option to get the best performance.
- **Smooth** — Select this option to produce a continuous curve (By area vs. opening table) or surface (By pressure-flow characteristic) with continuous first-order derivatives.

For more information on interpolation algorithms, see the PS Lookup Table (1D) and PS Lookup Table (2D) block reference pages.

Extrapolation method

Select one of the following extrapolation methods for determining the output value when the input value is outside the range specified in the argument list:

- **Linear** — Select this option to produce a curve or surface with continuous first-order derivatives in the extrapolation region and at the boundary with the interpolation region.
- **Nearest** — Select this option to produce an extrapolation that does not go above the highest point in the data or below the lowest point in the data.

For more information on extrapolation algorithms, see the PS Lookup Table (1D) and PS Lookup Table (2D) block reference pages.

Flow discharge coefficient

Semi-empirical parameter for valve capacity characterization. Its value depends on the geometrical properties of the valve, and usually is provided in textbooks or manufacturer data sheets. The default value is 0.7.

Laminar transition specification

Select how the block transitions between the laminar and turbulent regimes:

- **Pressure ratio** — The transition from laminar to turbulent regime is smooth and depends on the value of the **Laminar flow pressure ratio** parameter. This method provides better simulation robustness.
- **Reynolds number** — The transition from laminar to turbulent regime is assumed to take place when the Reynolds number reaches the value specified by the **Critical Reynolds number** parameter.

Laminar flow pressure ratio

Pressure ratio at which the flow transitions between laminar and turbulent regimes. The default value is 0.999. This parameter is visible only if the **Laminar transition specification** parameter is set to **Pressure ratio**.

Critical Reynolds number

The maximum Reynolds number for laminar flow. The value of the parameter depends on the orifice geometrical profile. You can find recommendations on the parameter value in hydraulics textbooks. The default value is 12, which corresponds to a round orifice in thin material with

sharp edges. This parameter is visible only if the **Laminar transition specification** parameter is set to Reynolds number.

Leakage area

The total area of possible leaks in the completely closed valve. The main purpose of the parameter is to maintain numerical integrity of the circuit by preventing a portion of the system from getting isolated after the valve is completely closed. The parameter value must be greater than 0. The default value is $1e-12 \text{ m}^2$.

Valve Opening Offsets Tab

Between ports P and B

Orifice opening of the **P-B** flow path at zero spool displacement. Specify a positive offset to model an underlapped valve or a negative offset to model an overlapped valve. The default value of θ corresponds to a zero-lapped valve. The default value is $2.5e-3 \text{ m}$.

Between ports B and T

Orifice opening of the **B-T** flow path at zero spool displacement. Specify a positive offset to model an underlapped valve or a negative offset to model an overlapped valve. The default value of θ corresponds to a zero-lapped valve. The default value is $2.5e-3 \text{ m}$.

Between ports A and T1

Orifice opening of the **A-T1** flow path at zero spool displacement. Specify a positive offset to model an underlapped valve or a negative offset to model an overlapped valve. The default value of θ corresponds to a zero-lapped valve. The default value is $2.5e-3 \text{ m}$.

Between ports T1 and T

Orifice opening of the **T1-T** flow path at zero spool displacement. Specify a positive offset to model an underlapped valve or a negative offset to model an overlapped valve. The default value of θ corresponds to a zero-lapped valve. The default value is $2.5e-3 \text{ m}$.

Ports

The block has the following ports:

P

Hydraulic conserving port associated with the pressure supply line inlet.

T

Hydraulic conserving port associated with the return line connection.

A

Hydraulic conserving port associated with the actuator connection port.

B

Hydraulic conserving port associated with the actuator connection port.

S

Physical signal port to control spool displacement.

Extended Capabilities

C/C++ Code Generation

Generate C and C++ code using Simulink® Coder™.

See Also

4-Way Directional Valve | 4-Way Directional Valve A | 4-Way Directional Valve C | 4-Way Directional Valve D | 4-Way Directional Valve E | 4-Way Directional Valve F | 4-Way Directional Valve G | 4-Way Directional Valve H | 4-Way Directional Valve K | 6-Way Directional Valve A

Topics

“Upgrading Simscape Fluids Models Containing Hydraulics (Isothermal) Blocks”

Introduced in R2009b

4-Way Directional Valve C

Configuration C of hydraulic continuous 4-way directional valve



Library

Directional Valves

Description

The 4-Way Directional Valve C block simulates a configuration of hydraulic continuous 4-way directional valve where port P is connected to port A and port B is connected to port T in the left position; in the right position, both port A and port B are connected to P; and all ports are interconnected in neutral position. The fluid is pumped in the valve through the inlet line P and is distributed between two outside hydraulic lines A and B (usually connected to a double-acting actuator) and the return line T. The block has four hydraulic connections, corresponding to inlet port (P), actuator ports (A and B), and return port (T), and one physical signal port connection (S), which controls the spool position. The block is built of a Fixed Orifice block in the P-B path and four Variable Orifice blocks, connected as shown in the following diagram.

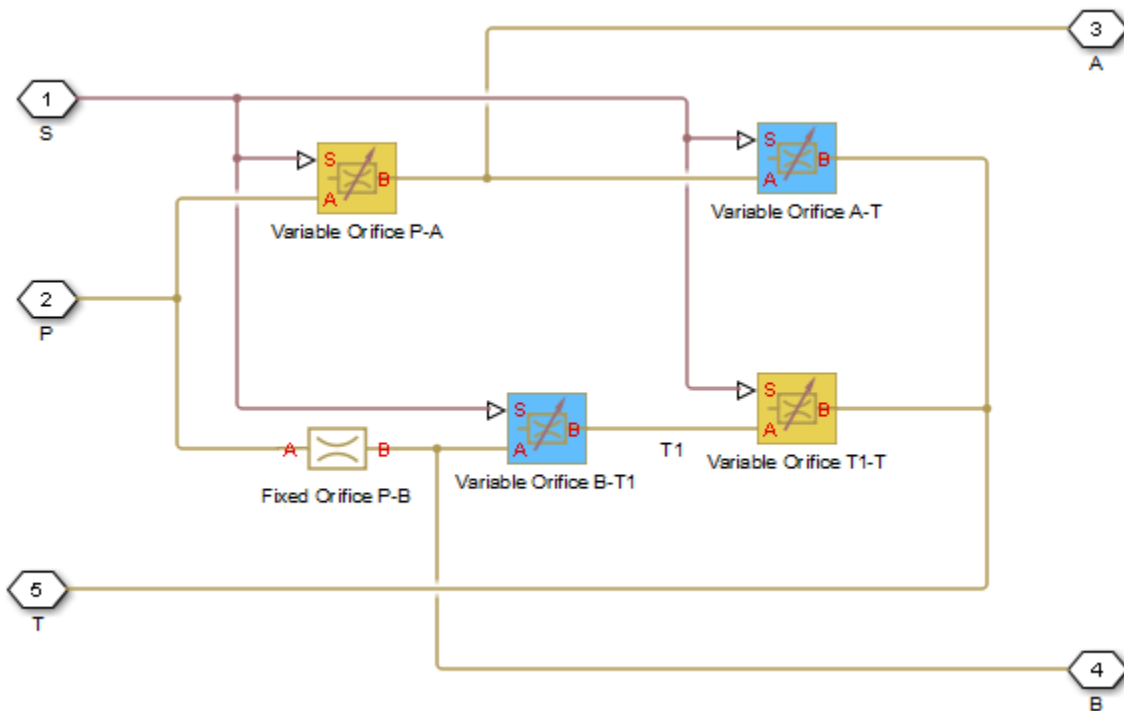

All Variable Orifice blocks are controlled by the same position signal, provided through the physical signal port S, but the **Orifice orientation** parameter in the block instances is set in such a way that positive signal at port S opens the orifices colored blue in the block diagram (orifices B-T1 and A-T) and closes the orifices colored yellow (orifices P-A and T1-T). As a result, the openings of the orifices are computed as follows:

$$h_{PA} = h_{PA0} - x$$

$$h_{AT} = h_{AT0} + x$$

$$h_{BT1} = h_{BT10} + x$$

$$h_{T1T} = h_{T1T0} - x$$

where

h_{PA}	Orifice opening for the Variable Orifice P-A block
h_{AT}	Orifice opening for the Variable Orifice A-T block
h_{BT1}	Orifice opening for the Variable Orifice B-T1 block
h_{T1T}	Orifice opening for the Variable Orifice T1-T block
h_{PA0}	Initial opening for the Variable Orifice P-A block
h_{PB0}	Initial opening for the Variable Orifice P-B block
h_{BT10}	Initial opening for the Variable Orifice B-T1 block
h_{T1T0}	Initial opening for the Variable Orifice T1-T block
x	Control member displacement from initial position

For information on the block parameterization options, basic parameter descriptions, assumptions and limitations, global and restricted parameters, see the 4-Way Directional Valve block reference page.

Parameters

- “Basic Parameters Tab” on page 1-143
- “Valve Opening Offsets Tab” on page 1-146

Basic Parameters Tab

Compared to the Basic Parameters tab of the 4-Way Directional Valve block, there is one additional parameter:

Path P-B passage area

Specify the area of the P-B passage. The parameter value must be greater than zero. The default value is $5e-5 \text{ m}^2$. This parameter is used if **Model parameterization** is set to **By maximum area and opening**.

The rest of the parameters on this tab are identical to those of the 4-Way Directional Valve block:

Model parameterization

Select one of the following methods for specifying the valve:

- **By maximum area and opening** — Provide values for the maximum valve passage area and the maximum valve opening. The passage area is linearly dependent on the control member displacement, that is, the valve is closed at the initial position of the control member (zero displacement), and the maximum opening takes place at the maximum displacement. This is the default method.
- **By area vs. opening table** — Provide tabulated data of valve openings and corresponding valve passage areas. The passage area is determined by one-dimensional table lookup. You have a choice of two interpolation methods and two extrapolation methods.
- **By pressure-flow characteristic** — Provide tabulated data of valve openings, pressure differentials, and corresponding flow rates. The flow rate is determined by two-dimensional table lookup. You have a choice of two interpolation methods and two extrapolation methods.

Valve passage maximum area

Specify the area of a fully opened valve. The parameter value must be greater than zero. The default value is $5e-5 \text{ m}^2$. This parameter is used if **Model parameterization** is set to **By maximum area and opening**.

Valve maximum opening

Specify the maximum displacement of the control member. The parameter value must be greater than zero. The default value is $5e-3 \text{ m}$. This parameter is used if **Model parameterization** is set to **By maximum area and opening**.

Valve opening vector, s

Specify the vector of input values for valve openings as a one-dimensional array. The input values vector must be strictly increasing. The values can be nonuniformly spaced. The minimum number of values depends on the interpolation method: you must provide at least two values for linear interpolation, at least three values for smooth interpolation. The default values, in meters, are $[-0.002 \ 0 \ 0.002 \ 0.005 \ 0.015]$. If **Model parameterization** is set to **By area vs. opening table**, the **Tabulated valve openings** values will be used together with **Tabulated valve passage area** values for one-dimensional table lookup. If **Model parameterization** is set to **By pressure-flow characteristic**, the **Tabulated valve openings** values will be used together with **Tabulated pressure differentials** and **Tabulated flow rates** for two-dimensional table lookup.

Valve passage area vector

Specify the vector of output values for valve passage area as a one-dimensional array. The valve passage area vector must be of the same size as the valve openings vector. All the values must be positive. The default values, in m^2 , are $[1e-09 \ 2.0352e-07 \ 4.0736e-05 \ 0.00011438 \ 0.00034356]$. This parameter is used if **Model parameterization** is set to **By area vs. opening table**.

Pressure differential vector, dp

Specify the vector of input values for pressure differentials as a one-dimensional array. The vector must be strictly increasing. The values can be nonuniformly spaced. The minimum number of values depends on the interpolation method: you must provide at least two values for linear interpolation, at least three values for smooth interpolation. The default values, in Pa, are $[-1e+07 \ -5e+06 \ -2e+06 \ 2e+06 \ 5e+06 \ 1e+07]$. This parameter is used if **Model parameterization** is set to **By pressure-flow characteristic**.

Volumetric flow rate table, q(s,dp)

Specify the flow rates as an m -by- n matrix, where m is the number of valve openings and n is the number of pressure differentials. Each value in the matrix specifies flow rate taking place at a specific combination of valve opening and pressure differential. The matrix size must match the dimensions defined by the input vectors. The default values, in m^3/s , are:

```
[-1e-07 -7.0711e-08 -4.4721e-08 4.4721e-08 7.0711e-08 1e-07;
-2.0352e-05 -1.4391e-05 -9.1017e-06 9.1017e-06 1.4391e-05 2.0352e-05;
-0.0040736 -0.0028805 -0.0018218 0.0018218 0.0028805 0.0040736;
-0.011438 -0.0080879 -0.0051152 0.0051152 0.0080879 0.011438;
-0.034356 -0.024293 -0.015364 0.015364 0.024293 0.034356;]
```

This parameter is used if **Model parameterization** is set to By pressure-flow characteristic.

Interpolation method

Select one of the following interpolation methods for approximating the output value when the input value is between two consecutive grid points:

- **Linear** — Select this option to get the best performance.
- **Smooth** — Select this option to produce a continuous curve (By area vs. opening table) or surface (By pressure-flow characteristic) with continuous first-order derivatives.

For more information on interpolation algorithms, see the PS Lookup Table (1D) and PS Lookup Table (2D) block reference pages.

Extrapolation method

Select one of the following extrapolation methods for determining the output value when the input value is outside the range specified in the argument list:

- **Linear** — Select this option to produce a curve or surface with continuous first-order derivatives in the extrapolation region and at the boundary with the interpolation region.
- **Nearest** — Select this option to produce an extrapolation that does not go above the highest point in the data or below the lowest point in the data.

For more information on extrapolation algorithms, see the PS Lookup Table (1D) and PS Lookup Table (2D) block reference pages.

Flow discharge coefficient

Semi-empirical parameter for valve capacity characterization. Its value depends on the geometrical properties of the valve, and usually is provided in textbooks or manufacturer data sheets. The default value is 0.7.

Laminar transition specification

Select how the block transitions between the laminar and turbulent regimes:

- **Pressure ratio** — The transition from laminar to turbulent regime is smooth and depends on the value of the **Laminar flow pressure ratio** parameter. This method provides better simulation robustness.
- **Reynolds number** — The transition from laminar to turbulent regime is assumed to take place when the Reynolds number reaches the value specified by the **Critical Reynolds number** parameter.

Laminar flow pressure ratio

Pressure ratio at which the flow transitions between laminar and turbulent regimes. The default value is 0.999. This parameter is visible only if the **Laminar transition specification** parameter is set to **Pressure ratio**.

Critical Reynolds number

The maximum Reynolds number for laminar flow. The value of the parameter depends on the orifice geometrical profile. You can find recommendations on the parameter value in hydraulics textbooks. The default value is 12, which corresponds to a round orifice in thin material with

sharp edges. This parameter is visible only if the **Laminar transition specification** parameter is set to Reynolds number.

Leakage area

The total area of possible leaks in the completely closed valve. The main purpose of the parameter is to maintain numerical integrity of the circuit by preventing a portion of the system from getting isolated after the valve is completely closed. The parameter value must be greater than 0. The default value is $1e-12 \text{ m}^2$.

Valve Opening Offsets Tab

Between ports P and A

Orifice opening of the **P-A** flow path at zero spool displacement. Specify a positive offset to model an underlapped valve or a negative offset to model an overlapped valve. The default value of θ corresponds to a zero-lapped valve. The default value is $2.5e-3 \text{ m}$.

Between ports A and T

Orifice opening of the **A-T** flow path at zero spool displacement. Specify a positive offset to model an underlapped valve or a negative offset to model an overlapped valve. The default value of θ corresponds to a zero-lapped valve. The default value is $2.5e-3 \text{ m}$.

Between ports B and T1

Orifice opening of the **B-T1** flow path at zero spool displacement. Specify a positive offset to model an underlapped valve or a negative offset to model an overlapped valve. The default value of θ corresponds to a zero-lapped valve. The default value is $2.5e-3 \text{ m}$.

Between ports T1 and T

Orifice opening of the **T1-T** flow path at zero spool displacement. Specify a positive offset to model an underlapped valve or a negative offset to model an overlapped valve. The default value of θ corresponds to a zero-lapped valve. The default value is $2.5e-3 \text{ m}$.

Ports

The block has the following ports:

P

Hydraulic conserving port associated with the pressure supply line inlet.

T

Hydraulic conserving port associated with the return line connection.

A

Hydraulic conserving port associated with the actuator connection port.

B

Hydraulic conserving port associated with the actuator connection port.

S

Physical signal port to control spool displacement.

Extended Capabilities

C/C++ Code Generation

Generate C and C++ code using Simulink® Coder™.

See Also

4-Way Directional Valve | 4-Way Directional Valve A | 4-Way Directional Valve B | 4-Way Directional Valve D | 4-Way Directional Valve E | 4-Way Directional Valve F | 4-Way Directional Valve G | 4-Way Directional Valve H | 4-Way Directional Valve K | 6-Way Directional Valve A

Topics

“Upgrading Simscape Fluids Models Containing Hydraulics (Isothermal) Blocks”

Introduced in R2009b

4-Way Directional Valve D

Configuration D of hydraulic continuous 4-way directional valve

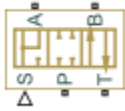

Library

Directional Valves

Description

The 4-Way Directional Valve D block simulates a configuration of hydraulic continuous 4-way directional valve. Ports A and B are connected to port P in the left valve position. In the right position, port P is connected to port A, while port B is connected to port T. All connections are blocked in neutral position. The fluid is pumped in the valve through the inlet line P and is distributed between two outside hydraulic lines A and B (usually connected to a double-acting actuator) and the return line T. The block has four hydraulic connections, corresponding to inlet port (P), actuator ports (A and B), and return port (T), and one physical signal port connection (S), which controls the spool position. The block is built of four Variable Orifice blocks, connected as shown in the following diagram.

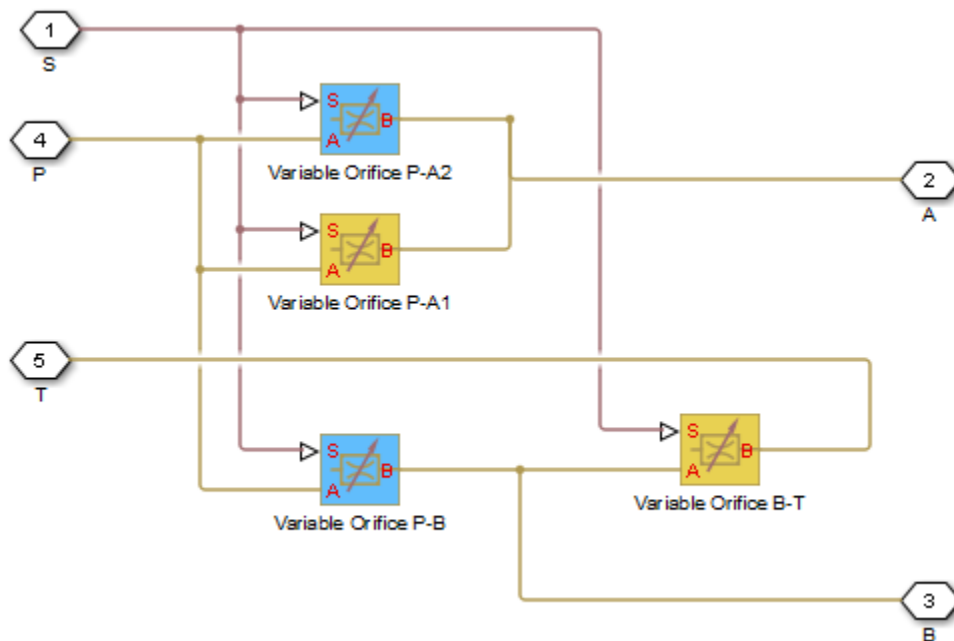

All Variable Orifice blocks are controlled by the same position signal, provided through the physical signal port S, but the **Orifice orientation** parameter in the block instances is set in such a way that

positive signal at port S opens the orifices colored blue in the block diagram (orifices P-A2 and P-B) and closes the orifices colored yellow (orifices P-A1 and B-T). As a result, the openings of the orifices are computed as follows:

$$h_{PA1} = h_{PA10} - x$$

$$h_{PA2} = h_{PA20} + x$$

$$h_{PB} = h_{PB0} + x$$

$$h_{BT} = h_{BT0} - x$$

where

h_{PA1}	Orifice opening for the Variable Orifice P-A1 block
h_{PA2}	Orifice opening for the Variable Orifice P-A2 block
h_{PB}	Orifice opening for the Variable Orifice P-B block
h_{BT}	Orifice opening for the Variable Orifice B-T block
h_{PA10}	Initial opening for the Variable Orifice P-A1 block
h_{PA20}	Initial opening for the Variable Orifice P-A2 block
h_{PB0}	Initial opening for the Variable Orifice P-B block
h_{BT0}	Initial opening for the Variable Orifice B-T block
x	Control member displacement from initial position

For information on the block parameterization options, basic parameter descriptions, assumptions and limitations, global and restricted parameters, see the 4-Way Directional Valve block reference page.

Parameters

- “Basic Parameters Tab” on page 1-149
- “Valve Opening Offsets Tab” on page 1-152

Basic Parameters Tab

Model parameterization

Select one of the following methods for specifying the valve:

- **By maximum area and opening** — Provide values for the maximum valve passage area and the maximum valve opening. The passage area is linearly dependent on the control member displacement, that is, the valve is closed at the initial position of the control member (zero displacement), and the maximum opening takes place at the maximum displacement. This is the default method.
- **By area vs. opening table** — Provide tabulated data of valve openings and corresponding valve passage areas. The passage area is determined by one-dimensional table lookup. You have a choice of two interpolation methods and two extrapolation methods.
- **By pressure-flow characteristic** — Provide tabulated data of valve openings, pressure differentials, and corresponding flow rates. The flow rate is determined by two-dimensional table lookup. You have a choice of two interpolation methods and two extrapolation methods.

Valve passage maximum area

Specify the area of a fully opened valve. The parameter value must be greater than zero. The default value is $5e-5 \text{ m}^2$. This parameter is used if **Model parameterization** is set to By maximum area and opening.

Valve maximum opening

Specify the maximum displacement of the control member. The parameter value must be greater than zero. The default value is $5e-3 \text{ m}$. This parameter is used if **Model parameterization** is set to By maximum area and opening.

Valve opening vector, s

Specify the vector of input values for valve openings as a one-dimensional array. The input values vector must be strictly increasing. The values can be nonuniformly spaced. The minimum number of values depends on the interpolation method: you must provide at least two values for linear interpolation, at least three values for smooth interpolation. The default values, in meters, are $[-0.002 \ 0 \ 0.002 \ 0.005 \ 0.015]$. If **Model parameterization** is set to By area vs. opening table, the **Tabulated valve openings** values will be used together with **Tabulated valve passage area** values for one-dimensional table lookup. If **Model parameterization** is set to By pressure-flow characteristic, the **Tabulated valve openings** values will be used together with **Tabulated pressure differentials** and **Tabulated flow rates** for two-dimensional table lookup.

Valve passage area vector

Specify the vector of output values for valve passage area as a one-dimensional array. The valve passage area vector must be of the same size as the valve openings vector. All the values must be positive. The default values, in m^2 , are $[1e-09 \ 2.0352e-07 \ 4.0736e-05 \ 0.00011438 \ 0.00034356]$. This parameter is used if **Model parameterization** is set to By area vs. opening table.

Pressure differential vector, dp

Specify the vector of input values for pressure differentials as a one-dimensional array. The vector must be strictly increasing. The values can be nonuniformly spaced. The minimum number of values depends on the interpolation method: you must provide at least two values for linear interpolation, at least three values for smooth interpolation. The default values, in Pa, are $[-1e+07 \ -5e+06 \ -2e+06 \ 2e+06 \ 5e+06 \ 1e+07]$. This parameter is used if **Model parameterization** is set to By pressure-flow characteristic.

Volumetric flow rate table, q(s,dp)

Specify the flow rates as an m -by- n matrix, where m is the number of valve openings and n is the number of pressure differentials. Each value in the matrix specifies flow rate taking place at a specific combination of valve opening and pressure differential. The matrix size must match the dimensions defined by the input vectors. The default values, in m^3/s , are:

```
[-1e-07 -7.0711e-08 -4.4721e-08 4.4721e-08 7.0711e-08 1e-07;
-2.0352e-05 -1.4391e-05 -9.1017e-06 9.1017e-06 1.4391e-05 2.0352e-05;
-0.0040736 -0.0028805 -0.0018218 0.0018218 0.0028805 0.0040736;
-0.011438 -0.0080879 -0.0051152 0.0051152 0.0080879 0.011438;
-0.034356 -0.024293 -0.015364 0.015364 0.024293 0.034356;]
```

This parameter is used if **Model parameterization** is set to By pressure-flow characteristic.

Interpolation method

Select one of the following interpolation methods for approximating the output value when the input value is between two consecutive grid points:

- **Linear** — Select this option to get the best performance.
- **Smooth** — Select this option to produce a continuous curve (By area vs. opening table) or surface (By pressure-flow characteristic) with continuous first-order derivatives.

For more information on interpolation algorithms, see the PS Lookup Table (1D) and PS Lookup Table (2D) block reference pages.

Extrapolation method

Select one of the following extrapolation methods for determining the output value when the input value is outside the range specified in the argument list:

- **Linear** — Select this option to produce a curve or surface with continuous first-order derivatives in the extrapolation region and at the boundary with the interpolation region.
- **Nearest** — Select this option to produce an extrapolation that does not go above the highest point in the data or below the lowest point in the data.

For more information on extrapolation algorithms, see the PS Lookup Table (1D) and PS Lookup Table (2D) block reference pages.

Flow discharge coefficient

Semi-empirical parameter for valve capacity characterization. Its value depends on the geometrical properties of the valve, and usually is provided in textbooks or manufacturer data sheets. The default value is 0.7.

Laminar transition specification

Select how the block transitions between the laminar and turbulent regimes:

- **Pressure ratio** — The transition from laminar to turbulent regime is smooth and depends on the value of the **Laminar flow pressure ratio** parameter. This method provides better simulation robustness.
- **Reynolds number** — The transition from laminar to turbulent regime is assumed to take place when the Reynolds number reaches the value specified by the **Critical Reynolds number** parameter.

Laminar flow pressure ratio

Pressure ratio at which the flow transitions between laminar and turbulent regimes. The default value is 0.999. This parameter is visible only if the **Laminar transition specification** parameter is set to **Pressure ratio**.

Critical Reynolds number

The maximum Reynolds number for laminar flow. The value of the parameter depends on the orifice geometrical profile. You can find recommendations on the parameter value in hydraulics textbooks. The default value is 12, which corresponds to a round orifice in thin material with sharp edges. This parameter is visible only if the **Laminar transition specification** parameter is set to **Reynolds number**.

Leakage area

The total area of possible leaks in the completely closed valve. The main purpose of the parameter is to maintain numerical integrity of the circuit by preventing a portion of the system from getting isolated after the valve is completely closed. The parameter value must be greater than 0. The default value is $1e-12 \text{ m}^2$.

Valve Opening Offsets Tab

Between ports P and A1

Orifice opening of the **P-A1** flow path at zero spool displacement. Specify a positive offset to model an underlapped valve or a negative offset to model an overlapped valve. The default value of θ corresponds to a zero-lapped valve. The default value is $-2.5e-3$ m.

Between ports P and A2

Orifice opening of the **P-A2** flow path at zero spool displacement. Specify a positive offset to model an underlapped valve or a negative offset to model an overlapped valve. The default value of θ corresponds to a zero-lapped valve. The default value is $-2.5e-3$ m.

Between ports P and B

Orifice opening of the **P-B** flow path at zero spool displacement. Specify a positive offset to model an underlapped valve or a negative offset to model an overlapped valve. The default value of θ corresponds to a zero-lapped valve. The default value is $-2.5e-3$ m.

Between ports B and T

Orifice opening of the **B-T** flow path at zero spool displacement. Specify a positive offset to model an underlapped valve or a negative offset to model an overlapped valve. The default value of θ corresponds to a zero-lapped valve. The default value is $-2.5e-3$ m.

Ports

The block has the following ports:

P

Hydraulic conserving port associated with the pressure supply line inlet.

T

Hydraulic conserving port associated with the return line connection.

A

Hydraulic conserving port associated with the actuator connection port.

B

Hydraulic conserving port associated with the actuator connection port.

S

Physical signal port to control spool displacement.

Extended Capabilities

C/C++ Code Generation

Generate C and C++ code using Simulink® Coder™.

See Also

4-Way Directional Valve | 4-Way Directional Valve A | 4-Way Directional Valve B | 4-Way Directional Valve C | 4-Way Directional Valve E | 4-Way Directional Valve F | 4-Way Directional Valve G | 4-Way Directional Valve H | 4-Way Directional Valve K | 6-Way Directional Valve A

Topics

“Upgrading Simscape Fluids Models Containing Hydraulics (Isothermal) Blocks”

Introduced in R2009b

4-Way Directional Valve E

Configuration E of hydraulic continuous 4-way directional valve



Library

Directional Valves

Description

The 4-Way Directional Valve E block simulates a configuration of hydraulic continuous 4-way directional valve. Ports A and B are connected to port P in the right valve position. In the left position, port P is connected to port B, while port A is connected to port T. All connections are blocked in neutral position. The fluid is pumped in the valve through the inlet line P and is distributed between two outside hydraulic lines A and B (usually connected to a double-acting actuator) and the return line T. The block has four hydraulic connections, corresponding to inlet port (P), actuator ports (A and B), and return port (T), and one physical signal port connection (S), which controls the spool position. The block is built of four Variable Orifice blocks, connected as shown in the following diagram.

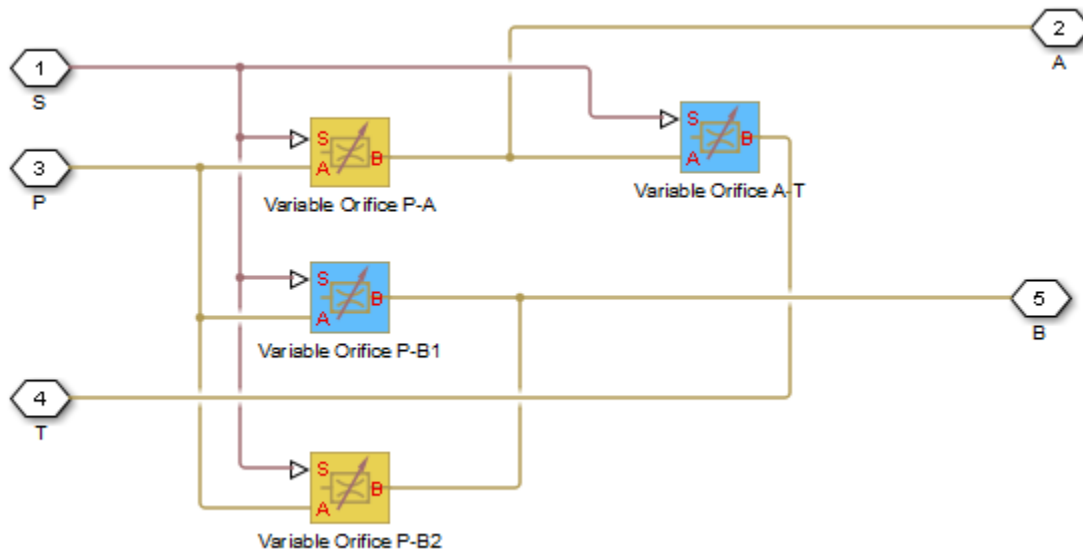

All Variable Orifice blocks are controlled by the same position signal, provided through the physical signal port S, but the **Orifice orientation** parameter in the block instances is set in such a way that positive signal at port S opens the orifices colored blue in the block diagram (orifices P-B1 and A-T) and closes the orifices colored yellow (orifices P-A and P-B2). As a result, the openings of the orifices are computed as follows:

$$h_{PA} = h_{PA0} - x$$

$$h_{PB1} = h_{PB10} + x$$

$$h_{PB2} = h_{PB20} - x$$

$$h_{AT} = h_{AT0} + x$$

where

h_{PA}	Orifice opening for the Variable Orifice P-A block
h_{PB1}	Orifice opening for the Variable Orifice P-B1 block
h_{PB2}	Orifice opening for the Variable Orifice P-B2 block
h_{AT}	Orifice opening for the Variable Orifice A-T block
h_{PA0}	Initial opening for the Variable Orifice P-A block
h_{PB10}	Initial opening for the Variable Orifice P-B1 block
h_{PB20}	Initial opening for the Variable Orifice P-B2 block
h_{AT0}	Initial opening for the Variable Orifice A-T block
x	Control member displacement from initial position

For information on the block parameterization options, basic parameter descriptions, assumptions and limitations, global and restricted parameters, see the 4-Way Directional Valve block reference page.

Parameters

- “Basic Parameters Tab” on page 1-155
- “Valve Opening Offsets Tab” on page 1-158

Basic Parameters Tab

Model parameterization

Select one of the following methods for specifying the valve:

- **By maximum area and opening** — Provide values for the maximum valve passage area and the maximum valve opening. The passage area is linearly dependent on the control member displacement, that is, the valve is closed at the initial position of the control member (zero displacement), and the maximum opening takes place at the maximum displacement. This is the default method.
- **By area vs. opening table** — Provide tabulated data of valve openings and corresponding valve passage areas. The passage area is determined by one-dimensional table lookup. You have a choice of two interpolation methods and two extrapolation methods.
- **By pressure-flow characteristic** — Provide tabulated data of valve openings, pressure differentials, and corresponding flow rates. The flow rate is determined by two-dimensional table lookup. You have a choice of two interpolation methods and two extrapolation methods.

Valve passage maximum area

Specify the area of a fully opened valve. The parameter value must be greater than zero. The default value is $5e-5 \text{ m}^2$. This parameter is used if **Model parameterization** is set to By maximum area and opening.

Valve maximum opening

Specify the maximum displacement of the control member. The parameter value must be greater than zero. The default value is $5e-3 \text{ m}$. This parameter is used if **Model parameterization** is set to By maximum area and opening.

Valve opening vector, s

Specify the vector of input values for valve openings as a one-dimensional array. The input values vector must be strictly increasing. The values can be nonuniformly spaced. The minimum number of values depends on the interpolation method: you must provide at least two values for linear interpolation, at least three values for smooth interpolation. The default values, in meters, are $[-0.002 \ 0 \ 0.002 \ 0.005 \ 0.015]$. If **Model parameterization** is set to By area vs. opening table, the **Tabulated valve openings** values will be used together with **Tabulated valve passage area** values for one-dimensional table lookup. If **Model parameterization** is set to By pressure-flow characteristic, the **Tabulated valve openings** values will be used together with **Tabulated pressure differentials** and **Tabulated flow rates** for two-dimensional table lookup.

Valve passage area vector

Specify the vector of output values for valve passage area as a one-dimensional array. The valve passage area vector must be of the same size as the valve openings vector. All the values must be positive. The default values, in m^2 , are $[1e-09 \ 2.0352e-07 \ 4.0736e-05 \ 0.00011438 \ 0.00034356]$. This parameter is used if **Model parameterization** is set to By area vs. opening table.

Pressure differential vector, dp

Specify the vector of input values for pressure differentials as a one-dimensional array. The vector must be strictly increasing. The values can be nonuniformly spaced. The minimum number of values depends on the interpolation method: you must provide at least two values for linear interpolation, at least three values for smooth interpolation. The default values, in Pa, are $[-1e+07 \ -5e+06 \ -2e+06 \ 2e+06 \ 5e+06 \ 1e+07]$. This parameter is used if **Model parameterization** is set to By pressure-flow characteristic.

Volumetric flow rate table, q(s,dp)

Specify the flow rates as an m -by- n matrix, where m is the number of valve openings and n is the number of pressure differentials. Each value in the matrix specifies flow rate taking place at a specific combination of valve opening and pressure differential. The matrix size must match the dimensions defined by the input vectors. The default values, in m^3/s , are:

```
[-1e-07 -7.0711e-08 -4.4721e-08 4.4721e-08 7.0711e-08 1e-07;
-2.0352e-05 -1.4391e-05 -9.1017e-06 9.1017e-06 1.4391e-05 2.0352e-05;
-0.0040736 -0.0028805 -0.0018218 0.0018218 0.0028805 0.0040736;
-0.011438 -0.0080879 -0.0051152 0.0051152 0.0080879 0.011438;
-0.034356 -0.024293 -0.015364 0.015364 0.024293 0.034356;]
```

This parameter is used if **Model parameterization** is set to By pressure-flow characteristic.

Interpolation method

Select one of the following interpolation methods for approximating the output value when the input value is between two consecutive grid points:

- **Linear** — Select this option to get the best performance.
- **Smooth** — Select this option to produce a continuous curve (By area vs. opening table) or surface (By pressure-flow characteristic) with continuous first-order derivatives.

For more information on interpolation algorithms, see the PS Lookup Table (1D) and PS Lookup Table (2D) block reference pages.

Extrapolation method

Select one of the following extrapolation methods for determining the output value when the input value is outside the range specified in the argument list:

- **Linear** — Select this option to produce a curve or surface with continuous first-order derivatives in the extrapolation region and at the boundary with the interpolation region.
- **Nearest** — Select this option to produce an extrapolation that does not go above the highest point in the data or below the lowest point in the data.

For more information on extrapolation algorithms, see the PS Lookup Table (1D) and PS Lookup Table (2D) block reference pages.

Flow discharge coefficient

Semi-empirical parameter for valve capacity characterization. Its value depends on the geometrical properties of the valve, and usually is provided in textbooks or manufacturer data sheets. The default value is 0.7.

Laminar transition specification

Select how the block transitions between the laminar and turbulent regimes:

- **Pressure ratio** — The transition from laminar to turbulent regime is smooth and depends on the value of the **Laminar flow pressure ratio** parameter. This method provides better simulation robustness.
- **Reynolds number** — The transition from laminar to turbulent regime is assumed to take place when the Reynolds number reaches the value specified by the **Critical Reynolds number** parameter.

Laminar flow pressure ratio

Pressure ratio at which the flow transitions between laminar and turbulent regimes. The default value is 0.999. This parameter is visible only if the **Laminar transition specification** parameter is set to **Pressure ratio**.

Critical Reynolds number

The maximum Reynolds number for laminar flow. The value of the parameter depends on the orifice geometrical profile. You can find recommendations on the parameter value in hydraulics textbooks. The default value is 12, which corresponds to a round orifice in thin material with sharp edges. This parameter is visible only if the **Laminar transition specification** parameter is set to **Reynolds number**.

Leakage area

The total area of possible leaks in the completely closed valve. The main purpose of the parameter is to maintain numerical integrity of the circuit by preventing a portion of the system from getting isolated after the valve is completely closed. The parameter value must be greater than 0. The default value is $1e-12 \text{ m}^2$.

Valve Opening Offsets Tab

Between ports P and A

Orifice opening of the **P-A** flow path at zero spool displacement. Specify a positive offset to model an underlapped valve or a negative offset to model an overlapped valve. The default value of θ corresponds to a zero-lapped valve. The default value is $-2.5e-3$ m.

Between ports A and T

Orifice opening of the **A-T** flow path at zero spool displacement. Specify a positive offset to model an underlapped valve or a negative offset to model an overlapped valve. The default value of θ corresponds to a zero-lapped valve. The default value is $-2.5e-3$ m.

Between ports P and B1

Orifice opening of the **P-B1** flow path at zero spool displacement. Specify a positive offset to model an underlapped valve or a negative offset to model an overlapped valve. The default value of θ corresponds to a zero-lapped valve. The default value is $-2.5e-3$ m.

Between ports P and B2

Orifice opening of the **P-B2** flow path at zero spool displacement. Specify a positive offset to model an underlapped valve or a negative offset to model an overlapped valve. The default value of θ corresponds to a zero-lapped valve. The default value is $-2.5e-3$ m.

Ports

The block has the following ports:

P

Hydraulic conserving port associated with the pressure supply line inlet.

T

Hydraulic conserving port associated with the return line connection.

A

Hydraulic conserving port associated with the actuator connection port.

B

Hydraulic conserving port associated with the actuator connection port.

S

Physical signal port to control spool displacement.

Extended Capabilities

C/C++ Code Generation

Generate C and C++ code using Simulink® Coder™.

See Also

4-Way Directional Valve | 4-Way Directional Valve A | 4-Way Directional Valve B | 4-Way Directional Valve C | 4-Way Directional Valve D | 4-Way Directional Valve F | 4-Way Directional Valve G | 4-Way Directional Valve H | 4-Way Directional Valve K | 6-Way Directional Valve A

Topics

“Upgrading Simscape Fluids Models Containing Hydraulics (Isothermal) Blocks”

Introduced in R2009b

4-Way Directional Valve F

Configuration F of hydraulic continuous 4-way directional valve



Library

Directional Valves

Description

The 4-Way Directional Valve F block simulates a configuration of hydraulic continuous 4-way directional valve. Ports A and B are connected to port P in the left valve position. In the right position, port P is connected to port A, while port B is connected to port T. In neutral position, ports A and B are connected to port T. The fluid is pumped in the valve through the inlet line P and is distributed between two outside hydraulic lines A and B (usually connected to a double-acting actuator) and the return line T. The block has four hydraulic connections, corresponding to inlet port (P), actuator ports (A and B), and return port (T), and one physical signal port connection (S), which controls the spool position. The block is built of six Variable Orifice blocks, connected as shown in the following diagram.

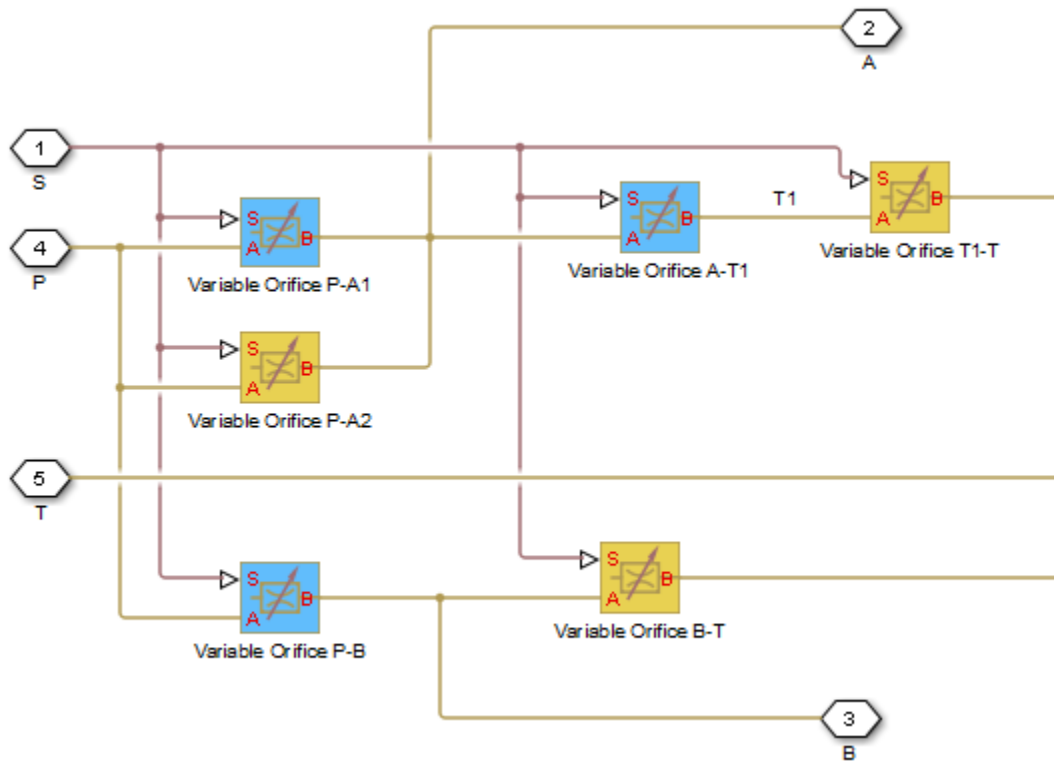

All Variable Orifice blocks are controlled by the same position signal, provided through the physical signal port S, but the **Orifice orientation** parameter in the block instances is set in such a way that positive signal at port S opens the orifices colored blue in the block diagram (orifices P-A1, A-T1, and P-B) and closes the orifices colored yellow (orifices P-A2, B-T, and T1-T). As a result, the openings of the orifices are computed as follows:

$$h_{PA1} = h_{PA10} + x$$

$$h_{PA2} = h_{PA20} - x$$

$$h_{AT1} = h_{AT10} + x$$

$$h_{T1T} = h_{T1T0} - x$$

$$h_{PB} = h_{PB0} + x$$

$$h_{BT} = h_{BT0} - x$$

where

h_{PA1}	Orifice opening for the Variable Orifice P-A1 block
h_{PA2}	Orifice opening for the Variable Orifice P-A2 block
h_{AT1}	Orifice opening for the Variable Orifice A-T1 block
h_{T1T}	Orifice opening for the Variable Orifice T1-T block
h_{PB}	Orifice opening for the Variable Orifice P-B block

h_{BT}	Orifice opening for the Variable Orifice B-T block
h_{PA10}	Initial opening for the Variable Orifice P-A1 block
h_{PA20}	Initial opening for the Variable Orifice P-A2 block
h_{AT10}	Initial opening for the Variable Orifice A-T1 block
h_{T1T0}	Initial opening for the Variable Orifice T1-T block
h_{PB0}	Initial opening for the Variable Orifice P-B block
h_{BT0}	Initial opening for the Variable Orifice B-T block
x	Control member displacement from initial position

For information on the block parameterization options, basic parameter descriptions, assumptions and limitations, global and restricted parameters, see the 4-Way Directional Valve block reference page.

Parameters

- “Basic Parameters Tab” on page 1-162
- “Valve Opening Offsets Tab” on page 1-164

Basic Parameters Tab

Model parameterization

Select one of the following methods for specifying the valve:

- **By maximum area and opening** — Provide values for the maximum valve passage area and the maximum valve opening. The passage area is linearly dependent on the control member displacement, that is, the valve is closed at the initial position of the control member (zero displacement), and the maximum opening takes place at the maximum displacement. This is the default method.
- **By area vs. opening table** — Provide tabulated data of valve openings and corresponding valve passage areas. The passage area is determined by one-dimensional table lookup. You have a choice of two interpolation methods and two extrapolation methods.
- **By pressure-flow characteristic** — Provide tabulated data of valve openings, pressure differentials, and corresponding flow rates. The flow rate is determined by two-dimensional table lookup. You have a choice of two interpolation methods and two extrapolation methods.

Valve passage maximum area

Specify the area of a fully opened valve. The parameter value must be greater than zero. The default value is $5e-5 \text{ m}^2$. This parameter is used if **Model parameterization** is set to **By maximum area and opening**.

Valve maximum opening

Specify the maximum displacement of the control member. The parameter value must be greater than zero. The default value is $5e-3 \text{ m}$. This parameter is used if **Model parameterization** is set to **By maximum area and opening**.

Valve opening vector, s

Specify the vector of input values for valve openings as a one-dimensional array. The input values vector must be strictly increasing. The values can be nonuniformly spaced. The minimum number of values depends on the interpolation method: you must provide at least two values for linear

interpolation, at least three values for smooth interpolation. The default values, in meters, are [-0.002 0 0.002 0.005 0.015]. If **Model parameterization** is set to **By area vs. opening table**, the **Tabulated valve openings** values will be used together with **Tabulated valve passage area** values for one-dimensional table lookup. If **Model parameterization** is set to **By pressure-flow characteristic**, the **Tabulated valve openings** values will be used together with **Tabulated pressure differentials** and **Tabulated flow rates** for two-dimensional table lookup.

Valve passage area vector

Specify the vector of output values for valve passage area as a one-dimensional array. The valve passage area vector must be of the same size as the valve openings vector. All the values must be positive. The default values, in m^2 , are [1e-09 2.0352e-07 4.0736e-05 0.00011438 0.00034356]. This parameter is used if **Model parameterization** is set to **By area vs. opening table**.

Pressure differential vector, dp

Specify the vector of input values for pressure differentials as a one-dimensional array. The vector must be strictly increasing. The values can be nonuniformly spaced. The minimum number of values depends on the interpolation method: you must provide at least two values for linear interpolation, at least three values for smooth interpolation. The default values, in Pa, are [-1e+07 -5e+06 -2e+06 2e+06 5e+06 1e+07]. This parameter is used if **Model parameterization** is set to **By pressure-flow characteristic**.

Volumetric flow rate table, q(s,dp)

Specify the flow rates as an m -by- n matrix, where m is the number of valve openings and n is the number of pressure differentials. Each value in the matrix specifies flow rate taking place at a specific combination of valve opening and pressure differential. The matrix size must match the dimensions defined by the input vectors. The default values, in m^3/s , are:

```
[-1e-07 -7.0711e-08 -4.4721e-08 4.4721e-08 7.0711e-08 1e-07;
-2.0352e-05 -1.4391e-05 -9.1017e-06 9.1017e-06 1.4391e-05 2.0352e-05;
-0.0040736 -0.0028805 -0.0018218 0.0018218 0.0028805 0.0040736;
-0.011438 -0.0080879 -0.0051152 0.0051152 0.0080879 0.011438;
-0.034356 -0.024293 -0.015364 0.015364 0.024293 0.034356;]
```

This parameter is used if **Model parameterization** is set to **By pressure-flow characteristic**.

Interpolation method

Select one of the following interpolation methods for approximating the output value when the input value is between two consecutive grid points:

- **Linear** — Select this option to get the best performance.
- **Smooth** — Select this option to produce a continuous curve (**By area vs. opening table**) or surface (**By pressure-flow characteristic**) with continuous first-order derivatives.

For more information on interpolation algorithms, see the PS Lookup Table (1D) and PS Lookup Table (2D) block reference pages.

Extrapolation method

Select one of the following extrapolation methods for determining the output value when the input value is outside the range specified in the argument list:

- **Linear** — Select this option to produce a curve or surface with continuous first-order derivatives in the extrapolation region and at the boundary with the interpolation region.

- **Nearest** — Select this option to produce an extrapolation that does not go above the highest point in the data or below the lowest point in the data.

For more information on extrapolation algorithms, see the PS Lookup Table (1D) and PS Lookup Table (2D) block reference pages.

Flow discharge coefficient

Semi-empirical parameter for valve capacity characterization. Its value depends on the geometrical properties of the valve, and usually is provided in textbooks or manufacturer data sheets. The default value is 0.7.

Laminar transition specification

Select how the block transitions between the laminar and turbulent regimes:

- **Pressure ratio** — The transition from laminar to turbulent regime is smooth and depends on the value of the **Laminar flow pressure ratio** parameter. This method provides better simulation robustness.
- **Reynolds number** — The transition from laminar to turbulent regime is assumed to take place when the Reynolds number reaches the value specified by the **Critical Reynolds number** parameter.

Laminar flow pressure ratio

Pressure ratio at which the flow transitions between laminar and turbulent regimes. The default value is 0.999. This parameter is visible only if the **Laminar transition specification** parameter is set to **Pressure ratio**.

Critical Reynolds number

The maximum Reynolds number for laminar flow. The value of the parameter depends on the orifice geometrical profile. You can find recommendations on the parameter value in hydraulics textbooks. The default value is 12, which corresponds to a round orifice in thin material with sharp edges. This parameter is visible only if the **Laminar transition specification** parameter is set to **Reynolds number**.

Leakage area

The total area of possible leaks in the completely closed valve. The main purpose of the parameter is to maintain numerical integrity of the circuit by preventing a portion of the system from getting isolated after the valve is completely closed. The parameter value must be greater than 0. The default value is $1e-12 \text{ m}^2$.

Valve Opening Offsets Tab

Between ports P and A1

Orifice opening of the **P-A1** flow path at zero spool displacement. Specify a positive offset to model an underlapped valve or a negative offset to model an overlapped valve. The default value of 0 corresponds to a zero-lapped valve. The default value is $-2.5e-3 \text{ m}$.

Between ports P and A2

Orifice opening of the **P-A2** flow path at zero spool displacement. Specify a positive offset to model an underlapped valve or a negative offset to model an overlapped valve. The default value of 0 corresponds to a zero-lapped valve. The default value is $-2.5e-3 \text{ m}$.

Between ports A and T1

Orifice opening of the **A-T1** flow path at zero spool displacement. Specify a positive offset to model an underlapped valve or a negative offset to model an overlapped valve. The default value of 0 corresponds to a zero-lapped valve. The default value is $2.5e-3 \text{ m}$.

Between ports T1 and T

Orifice opening of the **T1-T** flow path at zero spool displacement. Specify a positive offset to model an underlapped valve or a negative offset to model an overlapped valve. The default value of θ corresponds to a zero-lapped valve. The default value is $2.5e-3$ m.

Between ports P and B

Orifice opening of the **P-B** flow path at zero spool displacement. Specify a positive offset to model an underlapped valve or a negative offset to model an overlapped valve. The default value of θ corresponds to a zero-lapped valve. The default value is $-2.5e-3$ m.

Between ports B and T

Orifice opening of the **B-T** flow path at zero spool displacement. Specify a positive offset to model an underlapped valve or a negative offset to model an overlapped valve. The default value of θ corresponds to a zero-lapped valve. The default value is $2.5e-3$ m.

Ports

The block has the following ports:

P

Hydraulic conserving port associated with the pressure supply line inlet.

T

Hydraulic conserving port associated with the return line connection.

A

Hydraulic conserving port associated with the actuator connection port.

B

Hydraulic conserving port associated with the actuator connection port.

S

Physical signal port to control spool displacement.

Extended Capabilities**C/C++ Code Generation**

Generate C and C++ code using Simulink® Coder™.

See Also

4-Way Directional Valve | 4-Way Directional Valve A | 4-Way Directional Valve B | 4-Way Directional Valve C | 4-Way Directional Valve D | 4-Way Directional Valve E | 4-Way Directional Valve G | 4-Way Directional Valve H | 4-Way Directional Valve K | 6-Way Directional Valve A

Topics

“Upgrading Simscape Fluids Models Containing Hydraulics (Isothermal) Blocks”

Introduced in R2009b

4-Way Directional Valve G

Configuration G of hydraulic continuous 4-way directional valve



Library

Directional Valves

Description

The 4-Way Directional Valve G block simulates a configuration of hydraulic continuous 4-way directional valve. Ports A and B are connected to port P in the right valve position. In the left position, port P is connected to port B, while port A is connected to port T. In neutral position, ports A and B are connected to port T. The fluid is pumped in the valve through the inlet line P and is distributed between two outside hydraulic lines A and B (usually connected to a double-acting actuator) and the return line T. The block has four hydraulic connections, corresponding to inlet port (P), actuator ports (A and B), and return port (T), and one physical signal port connection (S), which controls the spool position. The block is built of six Variable Orifice blocks, connected as shown in the following diagram.

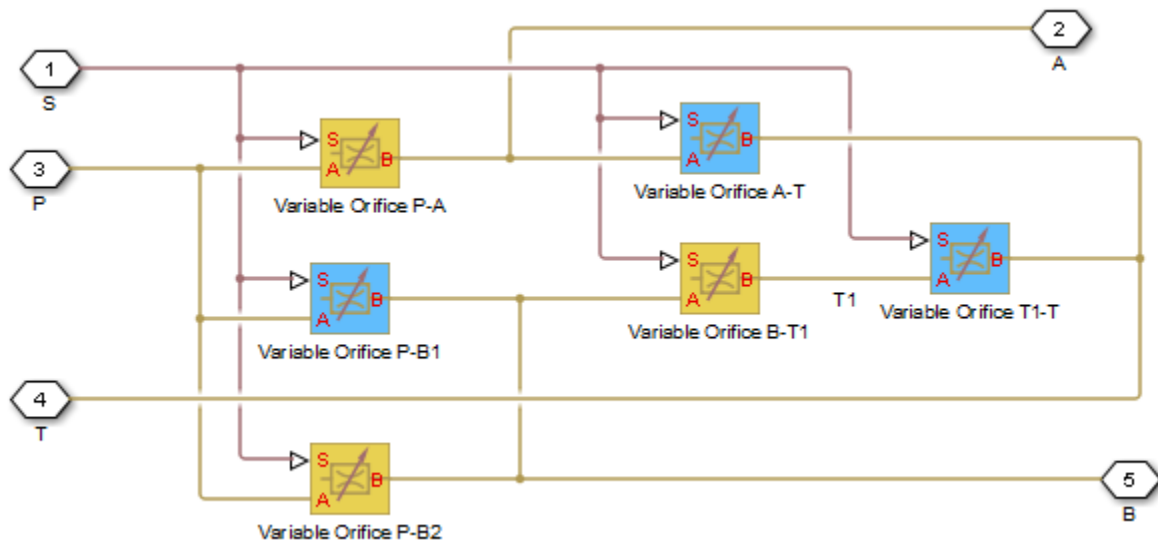

All Variable Orifice blocks are controlled by the same position signal, provided through the physical signal port S, but the **Orifice orientation** parameter in the block instances is set in such a way that positive signal at port S opens the orifices colored blue in the block diagram (orifices P-B1, A-T, and T1-T) and closes the orifices colored yellow (orifices P-A, B-T1, and P-B2). As a result, the openings of the orifices are computed as follows:

$$h_{PB1} = h_{PB10} + x$$

$$h_{PB2} = h_{PB20} - x$$

$$h_{BT1} = h_{BT10} - x$$

$$h_{T1T} = h_{T1T0} + x$$

$$h_{PA} = h_{PA0} - x$$

$$h_{AT} = h_{AT0} + x$$

where

h_{PB1}	Orifice opening for the Variable Orifice P-B1 block
h_{PB2}	Orifice opening for the Variable Orifice P-B2 block
h_{BT1}	Orifice opening for the Variable Orifice B-T1 block
h_{T1T}	Orifice opening for the Variable Orifice T1-T block
h_{PA}	Orifice opening for the Variable Orifice P-A block
h_{AT}	Orifice opening for the Variable Orifice A-T block
h_{PB10}	Initial opening for the Variable Orifice P-B1 block
h_{PB20}	Initial opening for the Variable Orifice P-B2 block
h_{BT10}	Initial opening for the Variable Orifice B-T1 block
h_{T1T0}	Initial opening for the Variable Orifice T1-T block
h_{PA0}	Initial opening for the Variable Orifice P-A block
h_{AT0}	Initial opening for the Variable Orifice A-T block
x	Control member displacement from initial position

For information on the block parameterization options, basic parameter descriptions, assumptions and limitations, global and restricted parameters, see the 4-Way Directional Valve block reference page.

Parameters

- “Basic Parameters Tab” on page 1-167
- “Valve Opening Offsets Tab” on page 1-170

Basic Parameters Tab

Model parameterization

Select one of the following methods for specifying the valve:

- By maximum area and opening — Provide values for the maximum valve passage area and the maximum valve opening. The passage area is linearly dependent on the control member displacement, that is, the valve is closed at the initial position of the control member (zero displacement), and the maximum opening takes place at the maximum displacement. This is the default method.

- **By area vs. opening table** — Provide tabulated data of valve openings and corresponding valve passage areas. The passage area is determined by one-dimensional table lookup. You have a choice of two interpolation methods and two extrapolation methods.
- **By pressure-flow characteristic** — Provide tabulated data of valve openings, pressure differentials, and corresponding flow rates. The flow rate is determined by two-dimensional table lookup. You have a choice of two interpolation methods and two extrapolation methods.

Valve passage maximum area

Specify the area of a fully opened valve. The parameter value must be greater than zero. The default value is $5e-5 \text{ m}^2$. This parameter is used if **Model parameterization** is set to **By maximum area and opening**.

Valve maximum opening

Specify the maximum displacement of the control member. The parameter value must be greater than zero. The default value is $5e-3 \text{ m}$. This parameter is used if **Model parameterization** is set to **By maximum area and opening**.

Valve opening vector, *s*

Specify the vector of input values for valve openings as a one-dimensional array. The input values vector must be strictly increasing. The values can be nonuniformly spaced. The minimum number of values depends on the interpolation method: you must provide at least two values for linear interpolation, at least three values for smooth interpolation. The default values, in meters, are $[-0.002 \ 0 \ 0.002 \ 0.005 \ 0.015]$. If **Model parameterization** is set to **By area vs. opening table**, the **Tabulated valve openings** values will be used together with **Tabulated valve passage area** values for one-dimensional table lookup. If **Model parameterization** is set to **By pressure-flow characteristic**, the **Tabulated valve openings** values will be used together with **Tabulated pressure differentials** and **Tabulated flow rates** for two-dimensional table lookup.

Valve passage area vector

Specify the vector of output values for valve passage area as a one-dimensional array. The valve passage area vector must be of the same size as the valve openings vector. All the values must be positive. The default values, in m^2 , are $[1e-09 \ 2.0352e-07 \ 4.0736e-05 \ 0.00011438 \ 0.00034356]$. This parameter is used if **Model parameterization** is set to **By area vs. opening table**.

Pressure differential vector, *dp*

Specify the vector of input values for pressure differentials as a one-dimensional array. The vector must be strictly increasing. The values can be nonuniformly spaced. The minimum number of values depends on the interpolation method: you must provide at least two values for linear interpolation, at least three values for smooth interpolation. The default values, in Pa, are $[-1e+07 \ -5e+06 \ -2e+06 \ 2e+06 \ 5e+06 \ 1e+07]$. This parameter is used if **Model parameterization** is set to **By pressure-flow characteristic**.

Volumetric flow rate table, *q(s,dp)*

Specify the flow rates as an *m*-by-*n* matrix, where *m* is the number of valve openings and *n* is the number of pressure differentials. Each value in the matrix specifies flow rate taking place at a specific combination of valve opening and pressure differential. The matrix size must match the dimensions defined by the input vectors. The default values, in m^3/s , are:

```
[-1e-07 -7.0711e-08 -4.4721e-08 4.4721e-08 7.0711e-08 1e-07;
-2.0352e-05 -1.4391e-05 -9.1017e-06 9.1017e-06 1.4391e-05 2.0352e-05;
-0.0040736 -0.0028805 -0.0018218 0.0018218 0.0028805 0.0040736;
-0.011438 -0.0080879 -0.0051152 0.0051152 0.0080879 0.011438;
-0.034356 -0.024293 -0.015364 0.015364 0.024293 0.034356;]
```

This parameter is used if **Model parameterization** is set to `By pressure-flow characteristic`.

Interpolation method

Select one of the following interpolation methods for approximating the output value when the input value is between two consecutive grid points:

- **Linear** — Select this option to get the best performance.
- **Smooth** — Select this option to produce a continuous curve (`By area vs. opening table`) or surface (`By pressure-flow characteristic`) with continuous first-order derivatives.

For more information on interpolation algorithms, see the PS Lookup Table (1D) and PS Lookup Table (2D) block reference pages.

Extrapolation method

Select one of the following extrapolation methods for determining the output value when the input value is outside the range specified in the argument list:

- **Linear** — Select this option to produce a curve or surface with continuous first-order derivatives in the extrapolation region and at the boundary with the interpolation region.
- **Nearest** — Select this option to produce an extrapolation that does not go above the highest point in the data or below the lowest point in the data.

For more information on extrapolation algorithms, see the PS Lookup Table (1D) and PS Lookup Table (2D) block reference pages.

Flow discharge coefficient

Semi-empirical parameter for valve capacity characterization. Its value depends on the geometrical properties of the valve, and usually is provided in textbooks or manufacturer data sheets. The default value is `0.7`.

Laminar transition specification

Select how the block transitions between the laminar and turbulent regimes:

- **Pressure ratio** — The transition from laminar to turbulent regime is smooth and depends on the value of the **Laminar flow pressure ratio** parameter. This method provides better simulation robustness.
- **Reynolds number** — The transition from laminar to turbulent regime is assumed to take place when the Reynolds number reaches the value specified by the **Critical Reynolds number** parameter.

Laminar flow pressure ratio

Pressure ratio at which the flow transitions between laminar and turbulent regimes. The default value is `0.999`. This parameter is visible only if the **Laminar transition specification** parameter is set to `Pressure ratio`.

Critical Reynolds number

The maximum Reynolds number for laminar flow. The value of the parameter depends on the orifice geometrical profile. You can find recommendations on the parameter value in hydraulics textbooks. The default value is `12`, which corresponds to a round orifice in thin material with sharp edges. This parameter is visible only if the **Laminar transition specification** parameter is set to `Reynolds number`.

Leakage area

The total area of possible leaks in the completely closed valve. The main purpose of the parameter is to maintain numerical integrity of the circuit by preventing a portion of the system

from getting isolated after the valve is completely closed. The parameter value must be greater than 0. The default value is $1e-12 \text{ m}^2$.

Valve Opening Offsets Tab

Between ports P and B1

Orifice opening of the **P-B1** flow path at zero spool displacement. Specify a positive offset to model an underlapped valve or a negative offset to model an overlapped valve. The default value of θ corresponds to a zero-lapped valve. The default value is $-2.5e-3 \text{ m}$.

Between ports P and B2

Orifice opening of the **P-B2** flow path at zero spool displacement. Specify a positive offset to model an underlapped valve or a negative offset to model an overlapped valve. The default value of θ corresponds to a zero-lapped valve. The default value is $-2.5e-3 \text{ m}$.

Between ports B and T1

Orifice opening of the **B-T1** flow path at zero spool displacement. Specify a positive offset to model an underlapped valve or a negative offset to model an overlapped valve. The default value of θ corresponds to a zero-lapped valve. The default value is $2.5e-3 \text{ m}$.

Between ports T1 and T

Orifice opening of the **T1-T** flow path at zero spool displacement. Specify a positive offset to model an underlapped valve or a negative offset to model an overlapped valve. The default value of θ corresponds to a zero-lapped valve. The default value is $2.5e-3 \text{ m}$.

Between ports P and A

Orifice opening of the **P-A** flow path at zero spool displacement. Specify a positive offset to model an underlapped valve or a negative offset to model an overlapped valve. The default value of θ corresponds to a zero-lapped valve. The default value is $-2.5e-3 \text{ m}$.

Between ports A and T

Orifice opening of the **B-T** flow path at zero spool displacement. Specify a positive offset to model an underlapped valve or a negative offset to model an overlapped valve. The default value of θ corresponds to a zero-lapped valve. The default value is $2.5e-3 \text{ m}$.

Ports

The block has the following ports:

P

Hydraulic conserving port associated with the pressure supply line inlet.

T

Hydraulic conserving port associated with the return line connection.

A

Hydraulic conserving port associated with the actuator connection port.

B

Hydraulic conserving port associated with the actuator connection port.

S

Physical signal port to control spool displacement.

Extended Capabilities

C/C++ Code Generation

Generate C and C++ code using Simulink® Coder™.

See Also

4-Way Directional Valve | 4-Way Directional Valve A | 4-Way Directional Valve B | 4-Way Directional Valve C | 4-Way Directional Valve D | 4-Way Directional Valve E | 4-Way Directional Valve F | 4-Way Directional Valve H | 4-Way Directional Valve K | 6-Way Directional Valve A

Topics

“Upgrading Simscape Fluids Models Containing Hydraulics (Isothermal) Blocks”

Introduced in R2009b

4-Way Directional Valve H

Configuration H of hydraulic continuous 4-way directional valve



Library

Directional Valves

Description

The 4-Way Directional Valve H block simulates a configuration of hydraulic continuous 4-way directional valve. Ports A and B are connected to port P in the left valve position. In the right position, port P is connected to port B, while port A is connected to port T. In neutral position, port P is connected to port T to unload the pump. The fluid is pumped in the valve through the inlet line P and is distributed between two outside hydraulic lines A and B (usually connected to a double-acting actuator) and the return line T. The block has four hydraulic connections, corresponding to inlet port (P), actuator ports (A and B), and return port (T), and one physical signal port connection (S), which controls the spool position. The block is built of six Variable Orifice blocks, connected as shown in the following diagram.

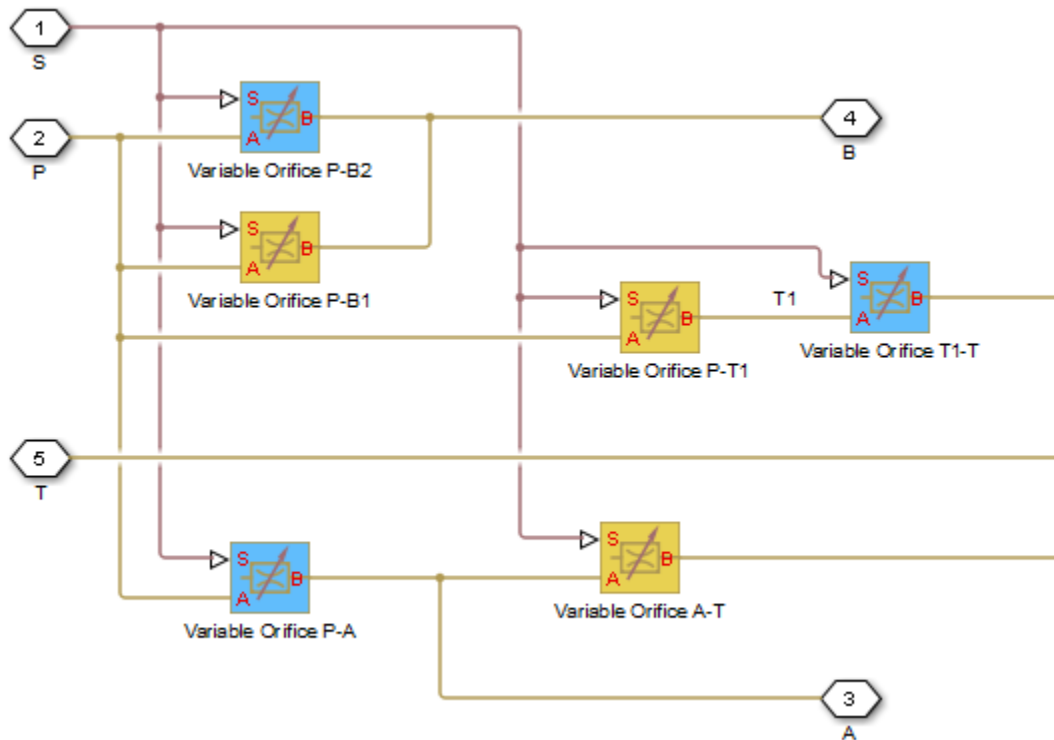

All Variable Orifice blocks are controlled by the same position signal, provided through the physical signal port S, but the **Orifice orientation** parameter in the block instances is set in such a way that positive signal at port S opens the orifices colored blue in the block diagram (orifices P-B2, P-A, and T1-T) and closes the orifices colored yellow (orifices P-B1, P-T1, and A-T). As a result, the openings of the orifices are computed as follows:

$$h_{PB1} = h_{PB10} - x$$

$$h_{PB2} = h_{PB20} + x$$

$$h_{PT1} = h_{PT10} - x$$

$$h_{T1T} = h_{T1T0} + x$$

$$h_{PA} = h_{PA0} + x$$

$$h_{AT} = h_{AT0} - x$$

where

h_{PB1}	Orifice opening for the Variable Orifice P-B1 block
h_{PB2}	Orifice opening for the Variable Orifice P-B2 block
h_{PT1}	Orifice opening for the Variable Orifice P-T1 block
h_{T1T}	Orifice opening for the Variable Orifice T1-T block
h_{PA}	Orifice opening for the Variable Orifice P-A block
h_{AT}	Orifice opening for the Variable Orifice A-T block
h_{PB10}	Initial opening for the Variable Orifice P-B1 block
h_{PB20}	Initial opening for the Variable Orifice P-B2 block
h_{PT10}	Initial opening for the Variable Orifice P-T1 block
h_{T1T0}	Initial opening for the Variable Orifice T1-T block
h_{PA0}	Initial opening for the Variable Orifice P-A block
h_{AT0}	Initial opening for the Variable Orifice A-T block
x	Control member displacement from initial position

For information on the block parameterization options, basic parameter descriptions, assumptions and limitations, global and restricted parameters, see the 4-Way Directional Valve block reference page.

Parameters

- “Basic Parameters Tab” on page 1-173
- “Valve Opening Offsets Tab” on page 1-176

Basic Parameters Tab

Model parameterization

Select one of the following methods for specifying the valve:

- **By maximum area and opening** — Provide values for the maximum valve passage area and the maximum valve opening. The passage area is linearly dependent on the control member displacement, that is, the valve is closed at the initial position of the control member (zero displacement), and the maximum opening takes place at the maximum displacement. This is the default method.
- **By area vs. opening table** — Provide tabulated data of valve openings and corresponding valve passage areas. The passage area is determined by one-dimensional table lookup. You have a choice of two interpolation methods and two extrapolation methods.
- **By pressure-flow characteristic** — Provide tabulated data of valve openings, pressure differentials, and corresponding flow rates. The flow rate is determined by two-dimensional table lookup. You have a choice of two interpolation methods and two extrapolation methods.

Valve passage maximum area

Specify the area of a fully opened valve. The parameter value must be greater than zero. The default value is $5e-5 \text{ m}^2$. This parameter is used if **Model parameterization** is set to **By maximum area and opening**.

Valve maximum opening

Specify the maximum displacement of the control member. The parameter value must be greater than zero. The default value is $5e-3 \text{ m}$. This parameter is used if **Model parameterization** is set to **By maximum area and opening**.

Valve opening vector, s

Specify the vector of input values for valve openings as a one-dimensional array. The input values vector must be strictly increasing. The values can be nonuniformly spaced. The minimum number of values depends on the interpolation method: you must provide at least two values for linear interpolation, at least three values for smooth interpolation. The default values, in meters, are $[-0.002 \ 0 \ 0.002 \ 0.005 \ 0.015]$. If **Model parameterization** is set to **By area vs. opening table**, the **Tabulated valve openings** values will be used together with **Tabulated valve passage area** values for one-dimensional table lookup. If **Model parameterization** is set to **By pressure-flow characteristic**, the **Tabulated valve openings** values will be used together with **Tabulated pressure differentials** and **Tabulated flow rates** for two-dimensional table lookup.

Valve passage area vector

Specify the vector of output values for valve passage area as a one-dimensional array. The valve passage area vector must be of the same size as the valve openings vector. All the values must be positive. The default values, in m^2 , are $[1e-09 \ 2.0352e-07 \ 4.0736e-05 \ 0.00011438 \ 0.00034356]$. This parameter is used if **Model parameterization** is set to **By area vs. opening table**.

Pressure differential vector, dp

Specify the vector of input values for pressure differentials as a one-dimensional array. The vector must be strictly increasing. The values can be nonuniformly spaced. The minimum number of values depends on the interpolation method: you must provide at least two values for linear interpolation, at least three values for smooth interpolation. The default values, in Pa, are $[-1e+07 \ -5e+06 \ -2e+06 \ 2e+06 \ 5e+06 \ 1e+07]$. This parameter is used if **Model parameterization** is set to **By pressure-flow characteristic**.

Volumetric flow rate table, q(s,dp)

Specify the flow rates as an m -by- n matrix, where m is the number of valve openings and n is the number of pressure differentials. Each value in the matrix specifies flow rate taking place at a specific combination of valve opening and pressure differential. The matrix size must match the dimensions defined by the input vectors. The default values, in m^3/s , are:

```
[-1e-07 -7.0711e-08 -4.4721e-08 4.4721e-08 7.0711e-08 1e-07;
-2.0352e-05 -1.4391e-05 -9.1017e-06 9.1017e-06 1.4391e-05 2.0352e-05;
-0.0040736 -0.0028805 -0.0018218 0.0018218 0.0028805 0.0040736;
-0.011438 -0.0080879 -0.0051152 0.0051152 0.0080879 0.011438;
-0.034356 -0.024293 -0.015364 0.015364 0.024293 0.034356;]
```

This parameter is used if **Model parameterization** is set to By pressure-flow characteristic.

Interpolation method

Select one of the following interpolation methods for approximating the output value when the input value is between two consecutive grid points:

- **Linear** — Select this option to get the best performance.
- **Smooth** — Select this option to produce a continuous curve (By area vs. opening table) or surface (By pressure-flow characteristic) with continuous first-order derivatives.

For more information on interpolation algorithms, see the PS Lookup Table (1D) and PS Lookup Table (2D) block reference pages.

Extrapolation method

Select one of the following extrapolation methods for determining the output value when the input value is outside the range specified in the argument list:

- **Linear** — Select this option to produce a curve or surface with continuous first-order derivatives in the extrapolation region and at the boundary with the interpolation region.
- **Nearest** — Select this option to produce an extrapolation that does not go above the highest point in the data or below the lowest point in the data.

For more information on extrapolation algorithms, see the PS Lookup Table (1D) and PS Lookup Table (2D) block reference pages.

Flow discharge coefficient

Semi-empirical parameter for valve capacity characterization. Its value depends on the geometrical properties of the valve, and usually is provided in textbooks or manufacturer data sheets. The default value is 0.7.

Laminar transition specification

Select how the block transitions between the laminar and turbulent regimes:

- **Pressure ratio** — The transition from laminar to turbulent regime is smooth and depends on the value of the **Laminar flow pressure ratio** parameter. This method provides better simulation robustness.
- **Reynolds number** — The transition from laminar to turbulent regime is assumed to take place when the Reynolds number reaches the value specified by the **Critical Reynolds number** parameter.

Laminar flow pressure ratio

Pressure ratio at which the flow transitions between laminar and turbulent regimes. The default value is 0.999. This parameter is visible only if the **Laminar transition specification** parameter is set to **Pressure ratio**.

Critical Reynolds number

The maximum Reynolds number for laminar flow. The value of the parameter depends on the orifice geometrical profile. You can find recommendations on the parameter value in hydraulics textbooks. The default value is 12, which corresponds to a round orifice in thin material with

sharp edges. This parameter is visible only if the **Laminar transition specification** parameter is set to Reynolds number.

Leakage area

The total area of possible leaks in the completely closed valve. The main purpose of the parameter is to maintain numerical integrity of the circuit by preventing a portion of the system from getting isolated after the valve is completely closed. The parameter value must be greater than 0. The default value is $1e-12 \text{ m}^2$.

Valve Opening Offsets Tab

Between ports P and B1

Orifice opening of the **P-B1** flow path at zero spool displacement. Specify a positive offset to model an underlapped valve or a negative offset to model an overlapped valve. The default value of θ corresponds to a zero-lapped valve. The default value is $-2.5e-3 \text{ m}$.

Between ports P and B2

Orifice opening of the **P-B2** flow path at zero spool displacement. Specify a positive offset to model an underlapped valve or a negative offset to model an overlapped valve. The default value of θ corresponds to a zero-lapped valve. The default value is $-2.5e-3 \text{ m}$.

Between ports P and T1

Orifice opening of the **P-T1** flow path at zero spool displacement. Specify a positive offset to model an underlapped valve or a negative offset to model an overlapped valve. The default value of θ corresponds to a zero-lapped valve. The default value is $2.5e-3 \text{ m}$.

Between ports T1 and T

Orifice opening of the **T1-T** flow path at zero spool displacement. Specify a positive offset to model an underlapped valve or a negative offset to model an overlapped valve. The default value of θ corresponds to a zero-lapped valve. The default value is $2.5e-3 \text{ m}$.

Between ports P and A

Orifice opening of the **P-A** flow path at zero spool displacement. Specify a positive offset to model an underlapped valve or a negative offset to model an overlapped valve. The default value of θ corresponds to a zero-lapped valve. The default value is $-2.5e-3 \text{ m}$.

Between ports A and T

Orifice opening of the **A-T** flow path at zero spool displacement. Specify a positive offset to model an underlapped valve or a negative offset to model an overlapped valve. The default value of θ corresponds to a zero-lapped valve. The default value is $2.5e-3 \text{ m}$.

Ports

The block has the following ports:

P

Hydraulic conserving port associated with the pressure supply line inlet.

T

Hydraulic conserving port associated with the return line connection.

A

Hydraulic conserving port associated with the actuator connection port.

B

Hydraulic conserving port associated with the actuator connection port.

S

Physical signal port to control spool displacement.

Extended Capabilities

C/C++ Code Generation

Generate C and C++ code using Simulink® Coder™.

See Also

4-Way Directional Valve | 4-Way Directional Valve A | 4-Way Directional Valve B | 4-Way Directional Valve C | 4-Way Directional Valve D | 4-Way Directional Valve E | 4-Way Directional Valve F | 4-Way Directional Valve G | 4-Way Directional Valve K | 6-Way Directional Valve A

Topics

“Upgrading Simscape Fluids Models Containing Hydraulics (Isothermal) Blocks”

Introduced in R2009b

4-Way Directional Valve K

Configuration K of hydraulic continuous 4-way directional valve

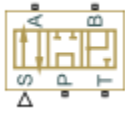

Library

Directional Valves

Description

The 4-Way Directional Valve K block simulates a configuration of hydraulic continuous 4-way directional valve. Ports A and B are connected to port P in the right valve position. In the left position, port P is connected to port B, while port A is connected to port T. In neutral position, port P is connected to port T to unload the pump. The fluid is pumped in the valve through the inlet line P and is distributed between two outside hydraulic lines A and B (usually connected to a double-acting actuator) and the return line T. The block has four hydraulic connections, corresponding to inlet port (P), actuator ports (A and B), and return port (T), and one physical signal port connection (S), which controls the spool position. The block is built of six Variable Orifice blocks, connected as shown in the following diagram.

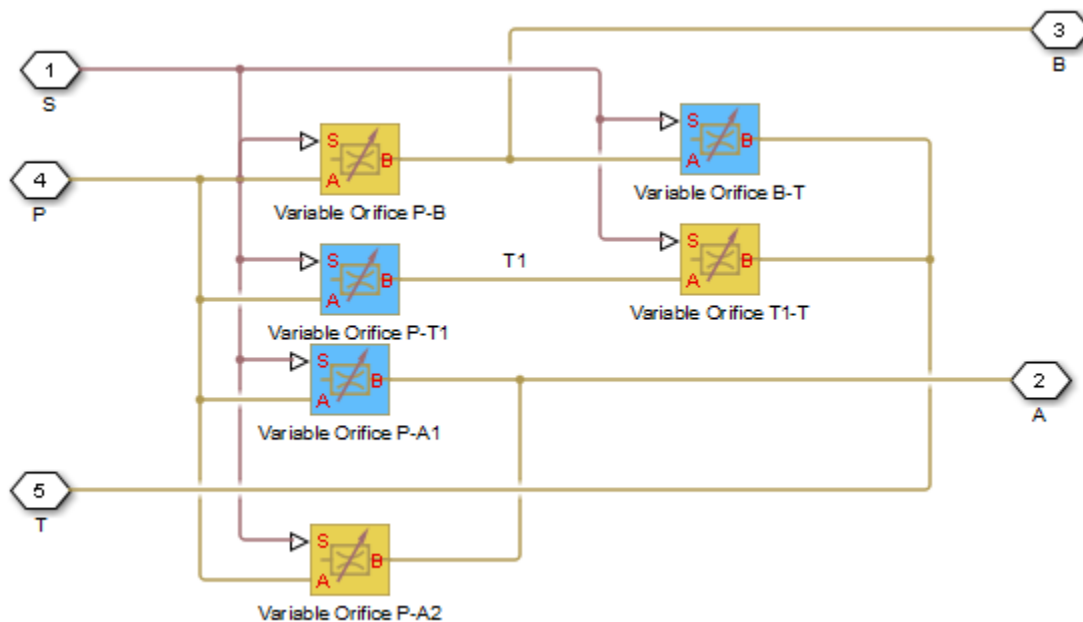

All Variable Orifice blocks are controlled by the same position signal, provided through the physical signal port S, but the **Orifice orientation** parameter in the block instances is set in such a way that

positive signal at port S opens the orifices colored blue in the block diagram (orifices P-A1, P-T1, and B-T) and closes the orifices colored yellow (orifices P-A2, P-B, and T1-T). As a result, the openings of the orifices are computed as follows:

$$h_{PA1} = h_{PA10} + x$$

$$h_{PA2} = h_{PA20} - x$$

$$h_{PT1} = h_{PT10} + x$$

$$h_{T1T} = h_{T1T0} - x$$

$$h_{PB} = h_{PB0} - x$$

$$h_{BT} = h_{BT0} + x$$

where

h_{PA1}	Orifice opening for the Variable Orifice P-A1 block
h_{PA2}	Orifice opening for the Variable Orifice P-A2 block
h_{PT1}	Orifice opening for the Variable Orifice P-T1 block
h_{T1T}	Orifice opening for the Variable Orifice T1-T block
h_{PB}	Orifice opening for the Variable Orifice P-B block
h_{BT}	Orifice opening for the Variable Orifice B-T block
h_{PA10}	Initial opening for the Variable Orifice P-A1 block
h_{PA20}	Initial opening for the Variable Orifice P-A2 block
h_{PT10}	Initial opening for the Variable Orifice P-T1 block
h_{T1T0}	Initial opening for the Variable Orifice T1-T block
h_{PB0}	Initial opening for the Variable Orifice P-B block
h_{BT0}	Initial opening for the Variable Orifice B-T block
x	Control member displacement from initial position

For information on the block parameterization options, basic parameter descriptions, assumptions and limitations, global and restricted parameters, see the 4-Way Directional Valve block reference page.

Parameters

- “Basic Parameters Tab” on page 1-179
- “Valve Opening Offsets Tab” on page 1-182

Basic Parameters Tab

Model parameterization

Select one of the following methods for specifying the valve:

- By maximum area and opening — Provide values for the maximum valve passage area and the maximum valve opening. The passage area is linearly dependent on the control member

displacement, that is, the valve is closed at the initial position of the control member (zero displacement), and the maximum opening takes place at the maximum displacement. This is the default method.

- **By area vs. opening table** — Provide tabulated data of valve openings and corresponding valve passage areas. The passage area is determined by one-dimensional table lookup. You have a choice of two interpolation methods and two extrapolation methods.
- **By pressure-flow characteristic** — Provide tabulated data of valve openings, pressure differentials, and corresponding flow rates. The flow rate is determined by two-dimensional table lookup. You have a choice of two interpolation methods and two extrapolation methods.

Valve passage maximum area

Specify the area of a fully opened valve. The parameter value must be greater than zero. The default value is $5e-5 \text{ m}^2$. This parameter is used if **Model parameterization** is set to **By maximum area and opening**.

Valve maximum opening

Specify the maximum displacement of the control member. The parameter value must be greater than zero. The default value is $5e-3 \text{ m}$. This parameter is used if **Model parameterization** is set to **By maximum area and opening**.

Valve opening vector, *s*

Specify the vector of input values for valve openings as a one-dimensional array. The input values vector must be strictly increasing. The values can be nonuniformly spaced. The minimum number of values depends on the interpolation method: you must provide at least two values for linear interpolation, at least three values for smooth interpolation. The default values, in meters, are $[-0.002 \ 0 \ 0.002 \ 0.005 \ 0.015]$. If **Model parameterization** is set to **By area vs. opening table**, the **Tabulated valve openings** values will be used together with **Tabulated valve passage area** values for one-dimensional table lookup. If **Model parameterization** is set to **By pressure-flow characteristic**, the **Tabulated valve openings** values will be used together with **Tabulated pressure differentials** and **Tabulated flow rates** for two-dimensional table lookup.

Valve passage area vector

Specify the vector of output values for valve passage area as a one-dimensional array. The valve passage area vector must be of the same size as the valve openings vector. All the values must be positive. The default values, in m^2 , are $[1e-09 \ 2.0352e-07 \ 4.0736e-05 \ 0.00011438 \ 0.00034356]$. This parameter is used if **Model parameterization** is set to **By area vs. opening table**.

Pressure differential vector, *dp*

Specify the vector of input values for pressure differentials as a one-dimensional array. The vector must be strictly increasing. The values can be nonuniformly spaced. The minimum number of values depends on the interpolation method: you must provide at least two values for linear interpolation, at least three values for smooth interpolation. The default values, in Pa, are $[-1e+07 \ -5e+06 \ -2e+06 \ 2e+06 \ 5e+06 \ 1e+07]$. This parameter is used if **Model parameterization** is set to **By pressure-flow characteristic**.

Volumetric flow rate table, *q(s,dp)*

Specify the flow rates as an *m*-by-*n* matrix, where *m* is the number of valve openings and *n* is the number of pressure differentials. Each value in the matrix specifies flow rate taking place at a specific combination of valve opening and pressure differential. The matrix size must match the dimensions defined by the input vectors. The default values, in m^3/s , are:

```
[-1e-07 -7.0711e-08 -4.4721e-08 4.4721e-08 7.0711e-08 1e-07;
-2.0352e-05 -1.4391e-05 -9.1017e-06 9.1017e-06 1.4391e-05 2.0352e-05;
```

```
-0.0040736 -0.0028805 -0.0018218 0.0018218 0.0028805 0.0040736;
-0.011438 -0.0080879 -0.0051152 0.0051152 0.0080879 0.011438;
-0.034356 -0.024293 -0.015364 0.015364 0.024293 0.034356;]
```

This parameter is used if **Model parameterization** is set to By pressure-flow characteristic.

Interpolation method

Select one of the following interpolation methods for approximating the output value when the input value is between two consecutive grid points:

- **Linear** — Select this option to get the best performance.
- **Smooth** — Select this option to produce a continuous curve (By area vs. opening table) or surface (By pressure-flow characteristic) with continuous first-order derivatives.

For more information on interpolation algorithms, see the PS Lookup Table (1D) and PS Lookup Table (2D) block reference pages.

Extrapolation method

Select one of the following extrapolation methods for determining the output value when the input value is outside the range specified in the argument list:

- **Linear** — Select this option to produce a curve or surface with continuous first-order derivatives in the extrapolation region and at the boundary with the interpolation region.
- **Nearest** — Select this option to produce an extrapolation that does not go above the highest point in the data or below the lowest point in the data.

For more information on extrapolation algorithms, see the PS Lookup Table (1D) and PS Lookup Table (2D) block reference pages.

Flow discharge coefficient

Semi-empirical parameter for valve capacity characterization. Its value depends on the geometrical properties of the valve, and usually is provided in textbooks or manufacturer data sheets. The default value is 0.7.

Laminar transition specification

Select how the block transitions between the laminar and turbulent regimes:

- **Pressure ratio** — The transition from laminar to turbulent regime is smooth and depends on the value of the **Laminar flow pressure ratio** parameter. This method provides better simulation robustness.
- **Reynolds number** — The transition from laminar to turbulent regime is assumed to take place when the Reynolds number reaches the value specified by the **Critical Reynolds number** parameter.

Laminar flow pressure ratio

Pressure ratio at which the flow transitions between laminar and turbulent regimes. The default value is 0.999. This parameter is visible only if the **Laminar transition specification** parameter is set to **Pressure ratio**.

Critical Reynolds number

The maximum Reynolds number for laminar flow. The value of the parameter depends on the orifice geometrical profile. You can find recommendations on the parameter value in hydraulics textbooks. The default value is 12, which corresponds to a round orifice in thin material with sharp edges. This parameter is visible only if the **Laminar transition specification** parameter is set to **Reynolds number**.

Leakage area

The total area of possible leaks in the completely closed valve. The main purpose of the parameter is to maintain numerical integrity of the circuit by preventing a portion of the system from getting isolated after the valve is completely closed. The parameter value must be greater than 0. The default value is $1e-12 \text{ m}^2$.

Valve Opening Offsets Tab**Between ports P and A1**

Orifice opening of the **P-A1** flow path at zero spool displacement. Specify a positive offset to model an underlapped valve or a negative offset to model an overlapped valve. The default value of θ corresponds to a zero-lapped valve. The default value is $-2.5e-3 \text{ m}$.

Between ports P and A2

Orifice opening of the **P-A2** flow path at zero spool displacement. Specify a positive offset to model an underlapped valve or a negative offset to model an overlapped valve. The default value of θ corresponds to a zero-lapped valve. The default value is $-2.5e-3 \text{ m}$.

Between ports P and T1

Orifice opening of the **P-T1** flow path at zero spool displacement. Specify a positive offset to model an underlapped valve or a negative offset to model an overlapped valve. The default value of θ corresponds to a zero-lapped valve. The default value is $2.5e-3 \text{ m}$.

Between ports T1 and T

Orifice opening of the **T1-T** flow path at zero spool displacement. Specify a positive offset to model an underlapped valve or a negative offset to model an overlapped valve. The default value of θ corresponds to a zero-lapped valve. The default value is $2.5e-3 \text{ m}$.

Between ports P and B

Orifice opening of the **P-B** flow path at zero spool displacement. Specify a positive offset to model an underlapped valve or a negative offset to model an overlapped valve. The default value of θ corresponds to a zero-lapped valve. The default value is $-2.5e-3 \text{ m}$.

Between ports B and T

Orifice opening of the **B-T** flow path at zero spool displacement. Specify a positive offset to model an underlapped valve or a negative offset to model an overlapped valve. The default value of θ corresponds to a zero-lapped valve. The default value is $2.5e-3 \text{ m}$.

Ports

The block has the following ports:

P

Hydraulic conserving port associated with the pressure supply line inlet.

T

Hydraulic conserving port associated with the return line connection.

A

Hydraulic conserving port associated with the actuator connection port.

B

Hydraulic conserving port associated with the actuator connection port.

S

Physical signal port to control spool displacement.

Extended Capabilities

C/C++ Code Generation

Generate C and C++ code using Simulink® Coder™.

See Also

4-Way Directional Valve | 4-Way Directional Valve A | 4-Way Directional Valve B | 4-Way Directional Valve C | 4-Way Directional Valve D | 4-Way Directional Valve E | 4-Way Directional Valve F | 4-Way Directional Valve G | 4-Way Directional Valve H | 6-Way Directional Valve A

Topics

“Upgrading Simscape Fluids Models Containing Hydraulics (Isothermal) Blocks”

Introduced in R2009b

4-Way Directional Valve (G)

Controlled valve with four ports and four flow paths

Library: Simscape / Fluids / Gas / Valves & Orifices / Directional Control Valves

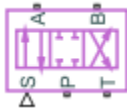

Description

The 4-Way Directional Valve (G) block models a valve with four gas ports (**P**, **A**, **B**, and **T**) and two sets of flow paths to switch between (**P-A** and **A-T**, **P-B** and **B-T**). The paths each run through an orifice of variable width, its opening being tied to the position of a control member. Think of the control member as a spool with two lands to cover (by degrees) the different orifices. The distance of a land to its appointed orifices determines if, and to what extent, those are open.

(The distances from the lands to the orifices are computed during simulation from the displacement signal specified at port **S**. They, and all distances related to spool position, are defined as unitless fractions, typically ranging from -1 to +1. The calculations are described in detail under “Orifice Opening Fractions” on page 1-186.)

The gas ports connect to what, in a representative system, are a pump (**P**), a tank (**T**), and a double-sided actuator (**A** and **B**). Opening the **P-A** and **B-T** flow paths allows the pump to pressurize one side of the actuator and the tank to relieve the other. The actuator shaft translates (to extend in some systems, to retract in others). Opening the alternate (**P-B** and **A-T**) flow paths flips the pressurized and relieved sides of the actuator so that its shaft can translate in reverse.

The port connections will vary with the system being modeled, but the purpose of the valve—to switch between flow paths and to regulate the flow passing through them—should not.

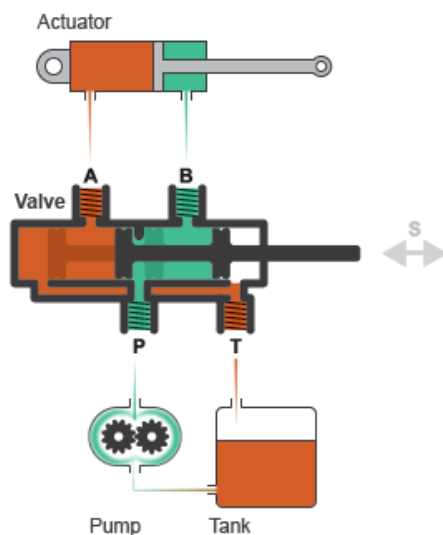

A Common Use of a 4-Way Directional Valve

The flow can be laminar or turbulent, and it can reach (up to) sonic speeds. This happens at the vena contracta, a point just past the throat of the valve where the flow is both its narrowest and fastest. The flow then chokes and its velocity saturates, with a drop in downstream pressure no longer sufficing to increase its velocity. Choking occurs when the back-pressure ratio hits a critical value characteristic of the valve. Supersonic flow is not captured by the block.

Valve Positions

The valve is continuously variable. It shifts smoothly between positions, of which it has three: one normal and two working.

The normal position is that to which the valve reverts when it is no longer being operated. The instantaneous displacement of the spool (given at port **S**) is then zero. Unless the lands of the spool are installed at an offset to their orifices, the valve will be fully closed.

The other two, the working positions, are those to which the valve moves when the spool is maximally displaced from its normal position. That displacement is positive in one case and negative in the other.

If it is positive, the **P-A** and **B-T** orifices are fully open and the **P-B** and **A-T** orifices are fully closed (position **I** in the figure). If it is negative, the **P-A** and **B-T** orifices are fully closed and the **P-B** and **A-T** orifices are fully open (position **II**).

I.

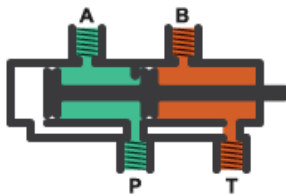

II.

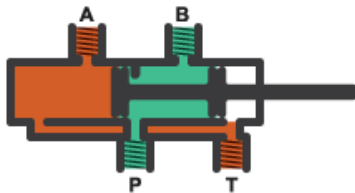

III.

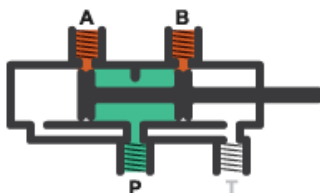

What spool displacement puts the valve in a working position depends on the offsets of the lands on the spool. These are generally applied before operation, in a real valve, and before simulation, in a valve model. They are specified in the block as constants (fixed from the start of simulation) in the **Valve Opening Fraction Offsets** tab.

Orifice Opening Fractions

Between valve positions, the opening of an orifice depends on where, relative to its rim, its land of the spool happens to be. This distance is the orifice opening, and it is normalized here so that its value is a fraction of its maximum (the distance at which the orifice is fully open). The normalized variable is referred to here as the *orifice opening fraction*.

The orifice opening fractions range from -1 in working position **I** to +1 in working position **II** (using the labels shown in the figure).

The opening fractions are calculated from the lengths already alluded to: the variable displacement of the control member (applied during operation) and the fixed offsets of its lands (applied during installation). These lengths are themselves defined as unitless fractions of the maximum land-orifice distance. (The offsets are referred to here as the *opening fraction offsets*.)

The opening fraction of the **P-A** orifice is:

$$h_{PA} = H_{PA} + x.$$

Likewise for the **B-T** orifice:

$$h_{BT} = H_{BT} + x.$$

That of the **A-T** orifice is:

$$h_{AT} = H_{AT} - x.$$

Lastly for the **P-B** orifice:

$$h_{PB} = H_{PB} - x.$$

In the equations:

- h is the opening fraction of the orifice denoted by the subscript. If the calculation should return a value outside of the range **0-1**, the nearest limit is used. (The orifice opening fractions are said to *saturate* at 0 and 1.)
- H is the opening fraction offset for the orifice denoted by the subscript. The offsets are each specified as a block parameter (in the **Valve Opening Fraction Offsets** tab). To allow for unusual valve configurations, no limit is imposed on their values, though generally these will fall between -1 and +1.
- x is the normalized instantaneous displacement of the spool, specified as a physical signal at port **S**. To compensate for equally extreme opening fraction offsets, no limit is imposed on its value (though generally it too will fall in the range of -1 to +1.)

Opening Fraction Offsets

The valve is by default configured so that it is fully closed when the spool displacement is zero. Such a valve is often described as being *zero-lapped*.

It is possible, by offsetting the lands of the spool, to model a valve that is underlapped (partially open in the normal valve position) or overlapped (fully closed not only *in* but also slightly *beyond* the normal position). The figure shows, for each case, how the orifice opening fractions vary with the instantaneous spool displacement:

- Case **I**: A zero-lapped valve. The opening fraction offsets are all zero. When the valve is in the normal position, the lands of the spool completely cover all four orifices.
- Case **II**: An underlapped valve. The **P-A** and **B-T** opening fraction offsets are positive and the **P-B** and the **A-T** opening fraction offsets are negative. When the valve is in the normal position, the lands of the spool cover all four orifices, but neither fully.
- Case **III**: An overlapped valve. The **P-A** and **B-T** opening fraction offsets are negative and the **P-B** and the **A-T** opening fraction offsets are positive. The control member completely covers all orifices not only in the normal position but over a small region (of spool displacements) around it.

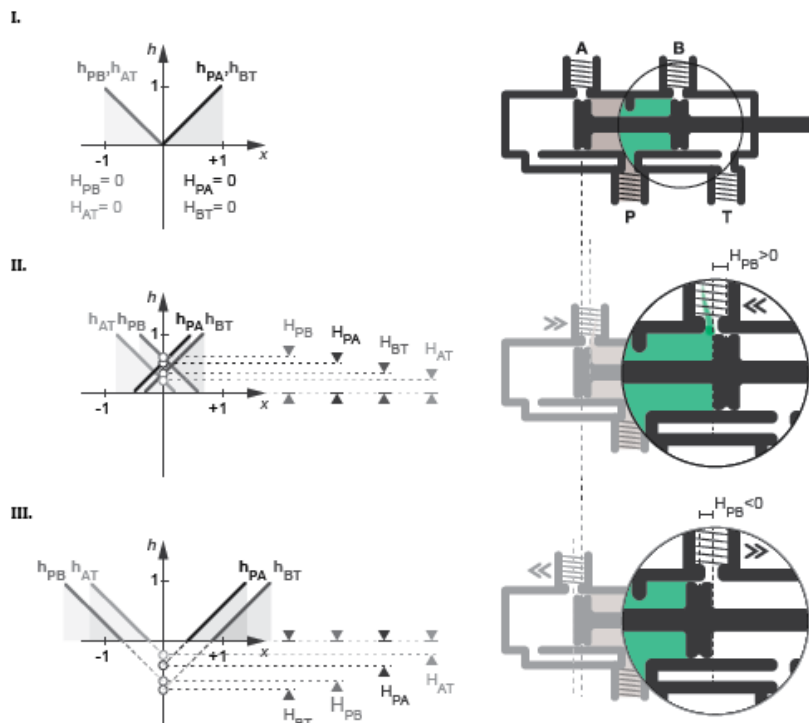

Opening Characteristics

It is common, when picking a valve for throttling or control applications, to match the flow characteristic of the valve to the system it is to regulate.

The flow characteristic relates the opening of the valve to the input that produces it, often spool travel. Here, the opening is expressed as a sonic conductance, flow coefficient, or restriction area (the choice between them being given by the **Valve parameterization** setting). The control input is the orifice opening fraction (a function of the spool displacement specified at port **S**).

The flow characteristic is normally given at steady state, with the inlet at a constant, carefully controlled pressure. This (inherent) flow characteristic depends only on the valve and it can be linear or nonlinear; the most common examples of the latter being the quick-opening and equal-percentage types. To capture such flow characteristics, the block provides a choice of opening parameterization (specified in the block parameter of the same name):

- **Linear** — The sonic conductance (C) is a linear function of the orifice opening fraction (h). In the default valve parameterization of Sonic conductance, the end points of the line are obtained at

opening fractions of 0 and 1 from the **Sonic conductance and leakage flow** and **Sonic conductance at maximum flow** block parameters.

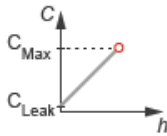

- **Tabulated data** — The sonic conductance is a general function (linear or nonlinear) of the orifice opening fraction. The function is specified in tabulated form, with the columns of the table deriving, in the default valve parameterization, from the **Opening fraction vector** and **Sonic conductance vector** block parameters.

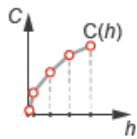

(If the **Valve parameterization** setting is other than **Sonic conductance**, the sonic conductance data is obtained by conversion from the chosen measure of valve opening (such as restriction area or flow coefficient). The opening data applies to all orifices equally.)

For controlled systems, it is important that the valve, once it is installed, be approximately linear in its flow characteristic. This (installed) characteristic depends on the remainder of the system—it is not generally the same as the inherent characteristic captured in the block. A pump, for example, may have a nonlinear characteristic that only a nonlinear valve, usually of the equal-percentage type, can adequately compensate for. It is cases of this sort that the **Tabulated data** option primarily targets.

Leakage Flow

The main purpose of leakage flow is to ensure that no section of a fluid network ever becomes isolated from the rest. Isolated fluid sections can reduce the numerical robustness of the model, slowing down the rate of simulation and, in some cases, causing it to fail altogether. While leakage flow is generally present in real valves, its exact value here is less important than its being a small number greater than zero. The leakage flow area is given in the block parameter of the same name.

Composite Structure

This block is a composite component comprising two instances of the Variable Orifice ISO 6358 (G) block connected to ports **P**, **A**, **T**, and **S** as shown below. Refer to that block for more detail on the valve parameterizations and block calculations (for example, those used to determine the mass flow rate through the ports).

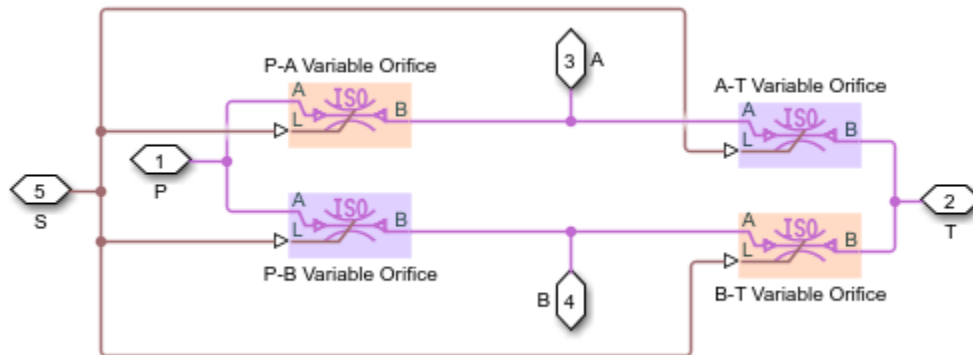

Ports

Input

S – Valve control signal, unitless

physical signal

Instantaneous displacement of the control member against its normal (unactuated) position, specified as a physical signal. The displacement is normalized against the maximum position of the control member (that required to open the orifice fully). See the block description for more information. The signal is unitless and its instantaneous value typically (though not always) in the range of -1 to $+1$.

Conserving

A – Valve opening

gas

Opening through which flow can enter or exit the valve.

B – Valve opening

gas

Opening through which flow can enter or exit the valve.

P – Valve opening

gas

Opening through which flow can enter or exit the valve.

T – Valve opening

gas

Opening through which flow can enter or exit the valve.

Parameters

Basic Parameters

Valve parameterization — Method by which to characterize the opening of the valve

Sonic conductance (default) | Cv coefficient (USCS) | Kv coefficient (SI) | Restriction area

Choice of ISO method to use in the calculation of mass flow rate. All calculations are based on the Sonic conductance parameterization; if a different option is selected, the data specified is converted into equivalent sonic conductance, critical pressure ratio, and subsonic index. See the calculations of the Variable Orifice ISO 6358 (G) block for detail on the conversions.

Opening parameterization — Method by which to calculate the opening characteristics of the valve

Linear (default) | Tabulated data

Method by which to calculate the opening area of the valve. The default setting treats the opening area as a linear function of the orifice opening fraction. The alternative setting allows for a general, nonlinear relationship to be specified (in tabulated form).

Cross-sectional area at ports A, B, P, and T — Area normal to the flow path at the valve ports

0.01 m² (default) | positive scalar in units of area

Area normal to the flow path at the valve ports. The ports are assumed to be of the same size. The flow area specified here should (ideally) match those of the inlets of adjoining components.

Laminar flow pressure ratio — Pressure ratio at which the flow transitions between laminar and turbulent regimes

0.999 (default) | positive unitless scalar

Pressure ratio at which the flow transitions between laminar and turbulent flow regimes. The pressure ratio is the fraction of the absolute pressure downstream of the valve over that just upstream of it. The flow is laminar when the actual pressure ratio is above the threshold specified here and turbulent when it is below. Typical values range from 0.995 to 0.999.

Reference temperature — ISO 8778 reference temperature

293.15 K (default) | scalar in units of temperature

Temperature at standard reference atmosphere, defined as 293.15 K in ISO 8778.

Reference density — ISO 8778 reference density

1.185 (default) | positive scalar in units of mass/volume

Density at standard reference atmosphere, defined as 1.185 kg/m³ in ISO 8778.

Model Parameterization

Sonic conductance at maximum flow — Measure of maximum flow rate at reference upstream conditions

1.6 l/s/bar (default) | positive scalar in units of volume/time/pressure

Equivalent measure of the maximum flow rate through the valve at some reference inlet conditions, generally those outlined in ISO 8778. The flow is at a maximum when the valve is fully open and the

flow velocity is choked (it being saturated at the local speed of sound). This is the value usually reported by manufacturers in technical data sheets.

Sonic conductance is defined as the ratio of the mass flow rate through the valve to the product of the pressure and density upstream of the valve inlet. This parameter is often referred to as the *C-value*.

Dependencies

This parameter is active and exposed in the block dialog box when the **Valve parameterization** setting is **Sonic conductance**.

Sonic conductance at leakage flow — Measure of minimum flow rate at reference upstream conditions

1e-5 l/s/bar (default) | positive scalar in units of volume/time/pressure

Equivalent measure of the minimum flow rate allowed through the valve at some reference inlet conditions, generally those outlined in ISO 8778. The flow is at a minimum when the valve is maximally closed and only a small leakage area—due to sealing imperfections, say, or natural valve tolerances—remains between its ports.

Sonic conductance is defined as the ratio of the mass flow rate through the valve to the product of the pressure and density upstream of the valve inlet. This parameter is often referred to in the literature as the *C-value*.

This parameter serves primarily to ensure that closure of the valve does not cause portions of the gas network to become isolated (a condition known to cause problems in simulation). The exact value specified here is less important than its being a (very small) number greater than zero.

Dependencies

This parameter is active and exposed in the block dialog box when the **Valve parameterization** setting is **Sonic conductance**.

Critical pressure ratio — Back-pressure ratio, at reference upstream conditions, at which the flow rate is a maximum

0.3 (default) | positive and unitless scalar

Ratio of downstream to upstream absolute pressures at which the flow becomes choked (and its velocity becomes saturated at the local speed of sound). This parameter is often referred to in the literature as the *b-value*. Enter a number greater than or equal to zero and smaller than the **Laminar flow pressure ratio** block parameter.

Dependencies

This parameter is active and exposed in the block dialog box when the **Valve parameterization** setting is **Sonic conductance**.

Subsonic index — Exponent used to more accurately characterize flow in the subsonic regime

0.5 (default) | positive unitless scalar

Empirical exponent used to more accurately calculate the mass flow rate through the valve when the flow is subsonic. This parameter is sometimes referred to as the *m-index*. Its value is approximately 0.5 for valves (and other components) whose flow paths are fixed.

Dependencies

This parameter is active and exposed in the block dialog box when the **Valve parameterization** setting is **Sonic conductance**.

Cv coefficient (USCS) at maximum flow — Flow coefficient of the fully open valve expressed in US customary units

0.4 (default) | positive scalar in units of ft^3/min

Flow coefficient of the fully open valve, expressed in the US customary units of ft^3/min (as described in NFPA T3.21.3). This parameter measures the relative ease with which the gas will traverse the valve when driven by a given pressure differential. This is the value generally reported by manufacturers in technical data sheets.

Dependencies

This parameter is active and exposed in the block dialog box when the **Valve parameterization** setting is **Cv coefficient (USCS)**.

Cv coefficient (USCS) at leakage flow — Flow coefficient of the maximally closed valve expressed in US customary units

1e-6 (default) | positive scalar in units of ft^3/min

Flow coefficient of the maximally closed valve, expressed in the US customary units of ft^3/min (as described in NFPA T3.21.3). This parameter measures the relative ease with which the gas will traverse the valve when driven by a given pressure differential.

The purpose of the leakage value is primarily to ensure that closure of the valve does not cause portions of the gas network to become isolated (a condition known to cause problems in simulation). The exact value specified here is less important than its being a (very small) number greater than zero.

Dependencies

This parameter is active and exposed in the block dialog box when the **Valve parameterization** setting is **Cv coefficient (USCS)**.

Kv coefficient (SI) at maximum flow — Flow coefficient of the fully open valve expressed in SI units

0.3 (default) | positive scalar in units of m^3/hr

Flow coefficient of the fully open valve, expressed in the SI units of m^3/hr . This parameter measures the relative ease with which the gas will traverse the valve when driven by a given pressure differential. This is the value generally reported by manufacturers in technical data sheets.

Dependencies

This parameter is active and exposed in the block dialog box when the **Valve parameterization** setting is **Kv coefficient (SI)**.

Kv coefficient (SI) at leakage flow — Flow coefficient of the maximally closed valve expressed in SI units

1e-6 (default) | positive scalar in units of m^3/hr

Flow coefficient of the maximally closed valve, expressed in the SI units of m^3/hr . This parameter measures the relative ease with which the gas will traverse the valve when driven by a given pressure differential.

The purpose of the leakage value is primarily to ensure that closure of the valve does not cause portions of the gas network to become isolated (a condition known to cause problems in simulation). The exact value specified here is less important than its being a (very small) number greater than zero.

Dependencies

This parameter is active and exposed in the block dialog box when the **Valve parameterization** setting is **Kv coefficient (SI)**.

Restriction area at maximum flow — Opening area in the fully open position due to sealing imperfections

$1\text{e-}4 \text{ m}^2$ (default) | positive scalar in units of area

Sum of the gauge pressures at the inlet and pilot port at which the valve is fully open. This value marks the end of the pressure range of the valve (over which the same progressively opens to allow for increased flow).

Dependencies

This parameter is active and exposed in the block dialog box when the **Valve parameterization** setting is **Restriction area**.

Restriction area at leakage flow — Opening area in the maximally closed position due to sealing imperfections

$1\text{e-}10$ (default)

Opening area of the valve in the maximally closed position, when only internal leakage between the ports remains. This parameter serves primarily to ensure that closure of the valve does not cause portions of the gas network to become isolated (a condition known to cause problems in simulation). The exact value specified here is less important than its being a (very small) number greater than zero.

Dependencies

This parameter is active and exposed in the block dialog box when the **Valve parameterization** setting is **Restriction area**.

Opening fraction vector — Orifice opening fractions at which to specify valve opening data

$0 : 0.2 : 1$ (default) | unitless vector with elements in the 0-1 range

Orifice opening fractions at which to specify the chosen measure of valve opening—sonic conductance, flow coefficient (in SI or USCS forms), or opening area.

This vector must be equal in size to that (or *those*, in the **Sonic conductance** parameterization) containing the valve opening data. The vector elements must be positive and increase monotonically in value from left to right.

Dependencies

This parameter is active and exposed in the block dialog box when the **Opening parameterization** setting is **Tabulated data**.

Sonic conductance vector — Vector of sonic conductances at given orifice opening fractions

[1e-05, .32, .64, .96, 1.28, 1.6] l/s/bar (default) | vector with units of volume/time/pressure

Sonic conductances at the breakpoints given in the **Opening fraction vector** parameter. This data forms the basis for a tabulated function relating the orifice opening fraction, sonic conductance, and critical pressure ratio. Linear interpolation is used within the tabulated data range; nearest-neighbor extrapolation is used outside of it. The two vectors—of sonic conductance and orifice opening fractions—must be of the same size.

Dependencies

This parameter is active and exposed in the block dialog box when the **Valve parameterization** setting is **Sonic conductance** and the **Opening parameterization** setting is **Tabulated data**.

Critical pressure ratio vector — Vector of critical pressure ratios at given orifice opening fractions

0.3 * ones(1, 6) (default) | unitless vector

Critical pressure ratios at the breakpoints given in the **Opening fraction vector** parameter. This data forms the basis for a tabulated function relating the orifice opening fraction, sonic conductance, and critical pressure ratio. Linear interpolation is used within the tabulated data range; nearest-neighbor extrapolation is used outside of it. The two vectors—of critical pressure ratios and orifice opening fractions—must be of the same size.

The values specified here must each be greater than or equal to zero and smaller than the **Laminar flow pressure ratio** block parameter.

Dependencies

This parameter is active and exposed in the block dialog box when the **Valve parameterization** setting is **Sonic conductance** and the **Opening parameterization** setting is **Tabulated data**.

Cv coefficient (USCS) vector — Vector of flow coefficients, in USCS units, at given orifice opening fractions

[1e-06, .08, .16, .24, .32, .4] (default) | vector in units of ft³/min

Flow coefficients, expressed in US customary units of ft³/min, at the breakpoints given in the **Opening fraction vector**. This data forms the basis for a tabulated function relating the two variables. Linear interpolation is used within the tabulated data range; nearest-neighbor extrapolation is used outside of it. The two vectors—of flow coefficients and orifice opening fractions—must be of the same size.

Dependencies

This parameter is active and exposed in the block dialog box when the **Valve parameterization** setting is **Cv coefficient (USCS)** and the **Opening parameterization** setting is **Tabulated data**.

Kv coefficient (SI) vector — Vector of flow coefficients, in SI units, at given orifice opening fractions

[1e-06, .06, .12, .18, .24, .3] (default) | vector in units of m³/hr

Flow coefficients, expressed in SI units of m³/hr, at the breakpoints given in the **Opening fraction vector** parameter. This data forms the basis for a tabulated function relating the two variables.

Linear interpolation is used within the tabulated data range; nearest-neighbor extrapolation is used outside of it. The two vectors—of flow coefficients and orifice opening fractions—must be of the same size.

Dependencies

This parameter is active and exposed in the block dialog box when the **Valve parameterization** setting is **Kv coefficient (SI)** and the **Opening parameterization** setting is **Tabulated data**.

Restriction area vector — Vector of opening areas at given orifice opening fractions

[1e-10, 2e-06, 4e-06, 6e-06, 8e-06, 1e-05] m² (default) | vector in units of area

Opening areas at the breakpoints given in the **Opening fraction vector** parameter. This data forms the basis for a tabulated function relating the two variables. Linear interpolation is used within the tabulated data range; nearest-neighbor extrapolation is used outside of it. The two vectors—of opening areas and orifice opening fractions—must be of the same size.

Dependencies

This parameter is active and exposed in the block dialog box when the **Valve parameterization** setting is **Restriction area** and the **Opening parameterization** setting is **Tabulated data**.

Smoothing factor — Amount of smoothing to apply to the valve opening function

0 (default) | positive unitless scalar

Amount of smoothing to apply to the opening function of the valve. This parameter determines the widths of the regions to be smoothed—one located at the fully open position, the other at the fully closed position.

The smoothing superposes on each region of the opening function a nonlinear segment (a third-order polynomial function, from which the smoothing arises). The greater the value specified here, the greater the smoothing is, and the broader the nonlinear segments become. See the Variable Orifice ISO 6358 (G) block for the impact of the smoothing on the block calculations.

At the default value of 0, no smoothing is applied. The transitions to the maximally closed and fully open positions then introduce discontinuities (associated with zero-crossings). These can slow down the rate of simulation.

Valve Opening Fraction Offsets

Between Ports P and A — Opening fraction offset for the P-A orifice

0 (default) | unitless scalar

Opening fraction of the **P-A** orifice when the spool displacement is zero. The valve is then in the normal position. The opening fraction measures the distance of a land of the spool to its appointed orifice (here **P-A**), normalized by the maximum such distance. It is unitless and (generally) between 0 and 1.

Between Ports B and T — Opening fraction offset for the B-T orifice

0 (default) | unitless scalar

Opening fraction of the **B-T** orifice when the spool displacement is zero. The valve is then in the normal position. The opening fraction measures the distance of a land of the spool to its appointed orifice (here **B-T**), normalized by the maximum such distance. It is unitless and (generally) between 0 and 1.

Between Ports P and B — Opening fraction offset for the P-B orifice \emptyset (default) | unitless scalar

Opening fraction of the **P-B** orifice when the spool displacement is zero. The valve is then in the normal position. The opening fraction measures the distance of a land of the spool to its appointed orifice (here **P-B**), normalized by the maximum such distance. It is unitless and (generally) between \emptyset and 1.

Between Ports A and T — Opening fraction offset for the A-T orifice \emptyset (default) | unitless scalar

Opening fraction of the **A-T** orifice when the spool displacement is zero. The valve is then in the normal position. The opening fraction measures the distance of a land of the spool to its appointed orifice (here **A-T**), normalized by the maximum such distance. It is unitless and (generally) between \emptyset and 1.

Extended Capabilities**C/C++ Code Generation**

Generate C and C++ code using Simulink® Coder™.

See Also

Variable Orifice ISO 6358 (G) | 2-Way Directional Valve (G) | 3-Way Directional Valve (G)

Introduced in R2018b

4-Way 3-Position Directional Valve (IL)

4-way, 3-position directional valve in an isothermal liquid system

Library: Simscape / Fluids / Isothermal Liquid / Valves & Orifices / Directional Control Valves

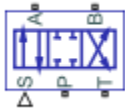

Description

The 4-Way 3-Position Directional Valve (IL) block models a valve with four openings in an isothermal liquid network, typically between an actuator, pump, and tank. The valve operation is controlled by a single spool displaced according to the signal at port **S**. You can set the baseline configuration of your valve by specifying the orifices that are open when the spool is in the neutral position (centered at 0 m) in the **Neutral spool position open connections** parameter, when the spool moves in the positive direction in the **Positive spool position open connections** parameter, and when the spool moves in the negative direction in the **Negative spool position open connections**.

You can set the model for valve opening in the **Orifice parameterization** parameter as a linear relationship or function of user-provided data, which can be applied to one or all flow paths in the valve.

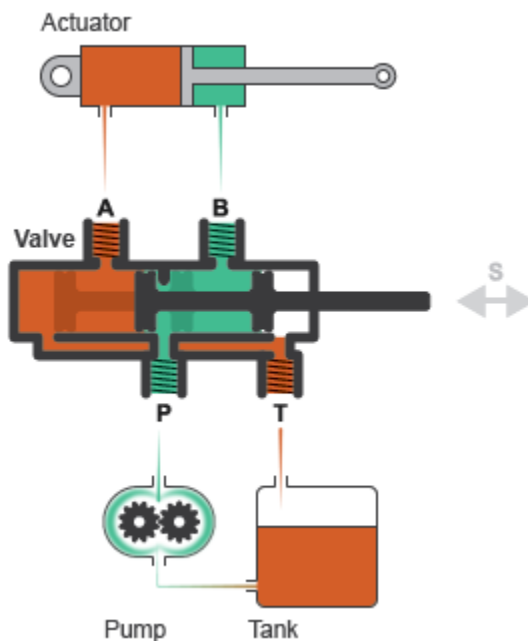

Example Valve Setup

In this example configuration, **Neutral spool position open connections** is set to All closed. When the spool is in the neutral position, all orifices are closed to flow:

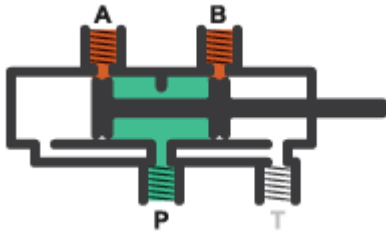

In this configuration, **Negative spool position open connections** is set to P-A and B-T. When the signal at port **S** moves the spool to a negative position, the paths between ports **P** and **A** and between ports **B** and **T** are open to flow. The paths between ports **P** and **B** and ports **A** and **T** are closed to flow:

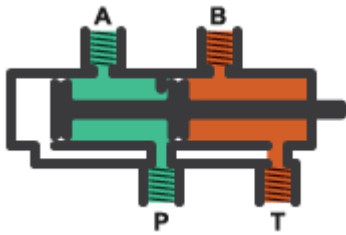

In this configuration, **Positive spool position open connections** is set to P-B and A-T. When the signal at port **S** moves the spool to a positive position, the paths between ports **P** and **B** and between ports **A** and **T** are open to flow and the paths between ports **P** and **A** and between ports **B** and **T** are closed:

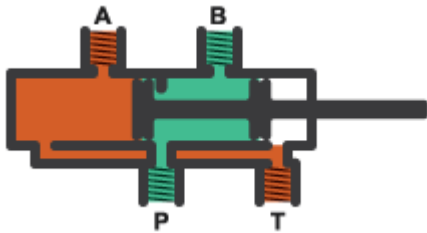

Schematically, this configuration is shown as:

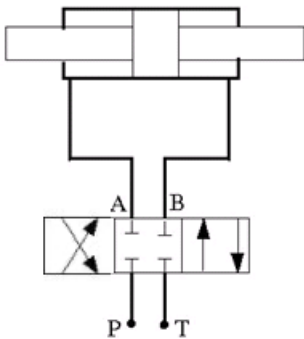

The left-hand side corresponds to the positive position and the right-hand side corresponds to the negative position.

Spool Displacement and Valve Configuration

The *spool stroke* is the amount of spool travel an orifice takes to fully open from a closed position and is defined for each orifice selected on the **Valve Configuration** tab. The table below shows how the stroke is calculated in accordance with the valve orifice parameterization and flow path characteristics.

Spool Stroke Based on Parameterization and Flow Path

Orifice Parameterization	Identical for All Flow Paths	Different for Each Flow Path
Linear - Area vs. spool travel	Defined by the Spool travel between closed and open orifice parameter	Defined by the Spool travel between closed and open orifice parameter, for each orifice
Tabulated data - Area vs. spool travel	The difference between the first and last element of the Spool travel vector parameter	The difference between the first and last element of the spool travel vector parameter for each orifice
Tabulated data - Volumetric flow rate vs. spool travel and pressure drop	The difference between the first and last element of the Spool travel vector, ds parameter	The difference between the first and last element of the spool travel vector, ds parameter for each orifice

The section “Visualize Orifice Openings” on page 1-209 details how to see the orientation of all valve orifices.

The direction of spool movement signaled at port **S** depends on the spool stroke and the orifice orientation:

Orifice Definition and Spool Travel Direction

Spool Position when Orifice is Open	Spool Travel, ΔS
Always closed (orifice is not selected in any spool position configuration)	N/A
Always open (orifice is selected in positive, neutral, and negative spool position configurations)	N/A
Negative	$S_{\text{orifice_max}} + \text{spool stroke} - \mathbf{S}$
Negative and Neutral	$S_{\text{orifice_max}} + \text{spool stroke} - \mathbf{S}$
Positive	$S_{\text{orifice_max}} + \text{spool stroke} + \mathbf{S}$
Positive and Neutral	$S_{\text{orifice_max}} + \text{spool stroke} + \mathbf{S}$
Neutral	$ S_{\text{orifice_max}} + \text{spool stroke} - \mathbf{S} $
Positive and Negative	$- S_{\text{orifice_max}} + \text{spool stroke} - \mathbf{S} $

Where $S_{\text{orifice_max}}$ is the spool position at the maximum orifice area defined for each orifice.

The **Consistency check for neutral spool position open connections** parameter verifies that

- Any orifice listed in **Neutral spool position open connections** is open when the signal at **S** is 0.
- Any orifice that is not listed in **Neutral spool position open connections** is closed when the signal at **S** is 0.

You can optionally choose to receive a warning or error when this check is violated.

The possible configurations of the 4-Way 3-Position Directional Valve (IL) block are shown below.

Note This block includes all configurations from the Hydraulic (Isothermal) library blocks 4-Way Directional Valve and the 4-Way Directional Valves A - K.

4-Way 3-Position Directional Valve Configuration

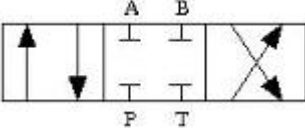
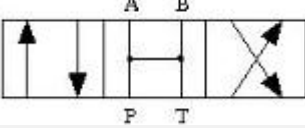
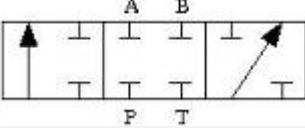
Configuration	Parameter Values
	<p>All four orifices are closed in the neutral position. (default)</p> <ul style="list-style-type: none"> • Positive spool position open connections: P-A and B-T • Neutral spool position open connections: All closed • Negative spool position open connections: P-B and A-T • Spool position at maximum P-A orifice area > P-A spool stroke • Spool position at maximum P-B orifice area < -P-B spool stroke • Spool position at maximum A-T orifice area < -A-T spool stroke • Spool position at maximum B-T orifice area > B-T spool stroke
	<p>All four orifices are open in the neutral position.</p> <ul style="list-style-type: none"> • Positive spool position open connections: P-A and B-T • Neutral spool position open connections: P-A, P-B, A-T, and B-T • Negative spool position open connections: P-B and A-T • Spool position at maximum P-A orifice area < P-A spool stroke • Spool position at maximum P-B orifice area > -P-B spool stroke • Spool position at maximum A-T orifice area > -A-T spool stroke • Spool position at maximum B-T orifice area < B-T spool stroke
	<p>Orifices A-T and B-T are closed. Orifices P-A and P-B are overlapped.</p> <ul style="list-style-type: none"> • Positive spool position open connections: P-A only • Neutral spool position open connections: All closed • Negative spool position open connections: P-B only • Spool position at maximum P-A orifice area > P-A spool stroke • Spool position at maximum P-B orifice area < -P-B spool stroke

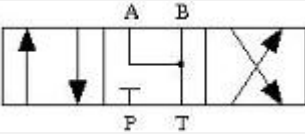
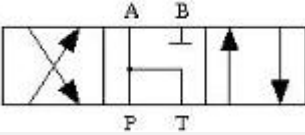
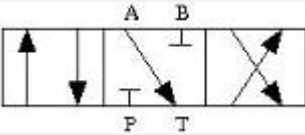
Configuration	Parameter Values
	<p>Orifices A-T and B-T are open. Orifices P-A and P-B are overlapped.</p> <ul style="list-style-type: none"> • Positive spool position open connections: P-A and B-T • Neutral spool position open connections: A-T and B-T • Negative spool position open connections: P-B and A-T • Spool position at maximum P-A orifice area > P-A spool stroke • Spool position at maximum P-B orifice area < P-B spool stroke • Spool position at maximum A-T orifice area > -A-T spool stroke • Spool position at maximum P-B orifice area < B-T spool stroke
	<p>Orifices P-A and A-T are open in the neutral position. Orifices P-B and B-T are overlapped.</p> <ul style="list-style-type: none"> • Positive spool position open connections: P-B and A-T • Neutral spool position open connections: P-A and A-T • Negative spool position open connections: P-A and B-T • Spool position at maximum P-A orifice area < P-A spool stroke • Spool position at maximum P-B orifice area > P-B spool stroke • Spool position at maximum A-T orifice area > A-T spool stroke • Spool position at maximum B-T orifice area < -B-T spool stroke
	<p>Orifice A-T is open in the neutral position. Orifices P-B, A-T, and B-T are overlapped.</p> <ul style="list-style-type: none"> • Positive spool position open connections: P-A and B-T • Neutral spool position open connections: A-T only • Negative spool position open connections: P-B and A-T • Spool position at maximum P-A orifice area > P-A spool stroke • Spool position at maximum P-B orifice area < -P-B spool stroke • Spool position at maximum A-T orifice area > -A-T spool stroke • Spool position at maximum B-T orifice area > B-T spool stroke

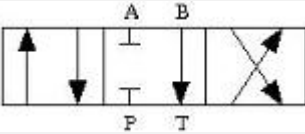
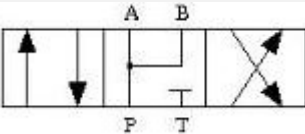
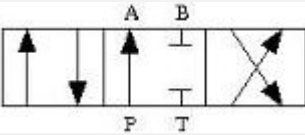
Configuration	Parameter Values
	<p>Orifice B-T is open in the neutral position. Orifices P-A, P-B, and A-T are overlapped.</p> <ul style="list-style-type: none"> • Positive spool position open connections: P-A and B-T • Neutral spool position open connections: B-T only • Negative spool position open connections: P-B and A-T • Spool position at maximum P-A orifice area > P-A spool stroke • Spool position at maximum P-B orifice area < -P-B spool stroke • Spool position at maximum A-T orifice area < -A-T spool stroke • Spool position at maximum B-T orifice area < B-T spool stroke
	<p>Orifices P-A and P-B are open. Orifices A-T and B-T are overlapped.</p> <ul style="list-style-type: none"> • Positive spool position open connections: P-A and B-T • Neutral spool position open connections: P-A and P-B • Negative spool position open connections: P-B and A-T • Spool position at maximum P-A orifice area < P-A spool stroke • Spool position at maximum P-B orifice area > -P-B spool stroke • Spool position at maximum A-T orifice area < -A-T spool stroke • Spool position at maximum B-T orifice area > B-T spool stroke
	<p>Orifice P-A is open in the neutral position. Orifices P-B, A-T, and B-T are overlapped.</p> <ul style="list-style-type: none"> • Positive spool position open connections: P-A and B-T • Neutral spool position open connections: P-A only • Negative spool position open connections: P-B and A-T • Spool position at maximum P-A orifice area < P-A spool stroke • Spool position at maximum P-B orifice area < -P-B spool stroke • Spool position at maximum A-T orifice area < -A-T spool stroke • Spool position at maximum B-T orifice area > B-T spool stroke

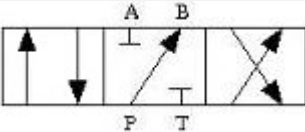
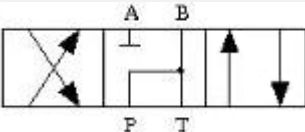
Configuration	Parameter Values
	<p>Orifice P-B is open in the neutral position. Orifices P-A, A-T, and B-T are overlapped.</p> <ul style="list-style-type: none"> • Positive spool position open connections: P-A and B-T • Neutral spool position open connections: P-B only • Negative spool position open connections: P-B and A-T • Spool position at maximum P-A orifice area > P-A spool stroke • Spool position at maximum P-B orifice area > -P-B spool stroke • Spool position at maximum A-T orifice area < -A-T spool stroke • Spool position at maximum B-T orifice area > B-T spool stroke
	<p>Orifices P-B and B-T are open in the neutral position. Orifices P-A and A-T are overlapped.</p> <ul style="list-style-type: none"> • Positive spool position open connections: P-B and A-T • Neutral spool position open connections: P-B and B-T • Negative spool position open connections: P-A and B-T • Spool position at maximum P-A orifice area < -P-A spool stroke • Spool position at maximum P-B orifice area < P-B spool stroke • Spool position at maximum A-T orifice area > A-T spool stroke • Spool position at maximum B-T orifice area > -B-T spool stroke

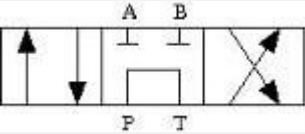
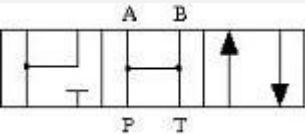
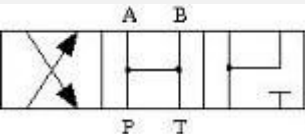
Configuration	Parameter Values
	<p>Orifices P-A, P-B, A-T, and B-T are closed in the neutral position. P-T is open in the neutral position and closes when the spool displaces.</p> <ul style="list-style-type: none"> • Positive spool position open connections: P-A and B-T • Neutral spool position open connections: P-T only • Negative spool position open connections: P-B and A-T • Spool position at maximum P-A orifice area > P-A spool stroke • Spool position at maximum P-B orifice area < -P-B spool stroke • Spool position at maximum A-T orifice area < -A-T spool stroke • Spool position at maximum B-T orifice area > B-T spool stroke • Spool position at maximum P-T orifice area = any value
	<p>Orifice P-A is a constant orifice. Orifices P-B, A-T, and B-T are open in the neutral position.</p> <ul style="list-style-type: none"> • Positive spool position open connections: P-A and P-B • Neutral spool position open connections: P-A, P-B, A-T, and B-T • Negative spool position open connections: P-A and B-T • Spool position at maximum P-A orifice area < P-A spool stroke • Spool position at maximum P-B orifice area < P-B spool stroke • Spool position at maximum A-T orifice area = any value • Spool position at maximum B-T orifice area > -B-T spool stroke
	<p>Orifice P-B is a constant orifice. Orifices P-A, A-T and B-T are open in the neutral position.</p> <ul style="list-style-type: none"> • Positive spool position open connections: P-B and A-T • Neutral spool position open connections: P-A, P-B, A-T, and B-T • Negative spool position open connections: P-A and P-B • Spool position at maximum P-A orifice area > -P-A spool stroke • Spool position at maximum A-T orifice area < A-T spool stroke • Spool position at maximum B-T orifice area = any value

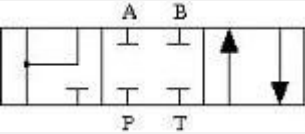
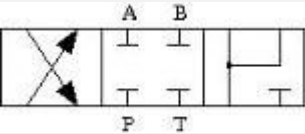
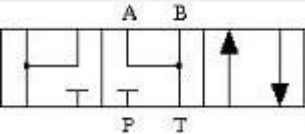
Configuration	Parameter Values
	<p>Orifice P-A is closed in the neutral position. Ports A and T do not form a flow path.</p> <ul style="list-style-type: none"> • Positive spool position open connections: P-A and P-B • Neutral spool position open connections: All closed • Negative spool position open connections: P-A and B-T • Spool position at maximum P-A orifice area > P-A spool stroke • Spool position at maximum P-B orifice area > P-B spool stroke • Spool position at maximum B-T orifice area < -B-T spool stroke
	<p>Orifice P-B is closed in the neutral position. Ports B and T do not form a flow path.</p> <ul style="list-style-type: none"> • Positive spool position open connections: P-B and A-T • Neutral spool position open connections: All closed • Negative spool position open connections: P-A and P-B • Spool position at maximum P-A orifice area < -P-A spool stroke • Spool position at maximum P-B orifice area > P-B spool stroke • Spool position at maximum A-T orifice area > A-T spool stroke
	<p>Orifice P-A is closed in the neutral position. Orifice A-T is open in the neutral position.</p> <ul style="list-style-type: none"> • Positive spool position open connections: P-A and P-B • Neutral spool position open connections: A-T and B-T • Negative spool position open connections: P-A and B-T • Spool position at maximum P-A orifice area > P-A spool stroke • Spool position at maximum P-B orifice area > P-B spool stroke • Spool position at maximum A-T orifice area = any value • Spool position at maximum B-T orifice area > -B-T spool stroke

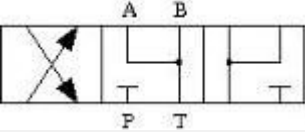
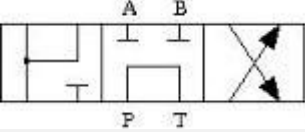
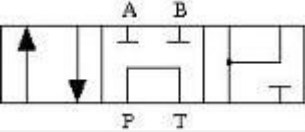
Configuration	Parameter Values
	<p>Orifice P-B is closed in the neutral position. Orifice B-T is open in the neutral position.</p> <ul style="list-style-type: none"> • Positive spool position open connections: P-B and A-T • Neutral spool position open connections: A-T and B-T • Negative spool position open connections: P-A and P-B • Spool position at maximum P-A orifice area < -P-A spool stroke • Spool position at maximum P-B orifice area > P-B spool stroke • Spool position at maximum A-T orifice area < A-T spool stroke • Spool position at maximum B-T orifice area = any value
	<p>Orifice P-B is closed in the neutral position. Orifice P-T is open in the neutral position. Ports A and T do not form a flow path.</p> <ul style="list-style-type: none"> • Positive spool position open connections: P-A and P-B • Neutral spool position open connections: P-T only • Negative spool position open connections: P-B and A-T • Spool position at maximum P-A orifice area > P-A spool stroke • Spool position at maximum P-B orifice area > P-B spool stroke • Spool position at maximum B-T orifice area < -B-T spool stroke • Spool position at maximum P-T orifice area = any value
	<p>Orifice P-A is closed in the neutral position. Orifice P-T is open in the neutral position. Ports A and T do not form a flow path.</p> <ul style="list-style-type: none"> • Positive spool position open connections: P-A and B-T • Neutral spool position open connections: P-T only • Negative spool position open connections: P-A and P-B • Spool position at maximum P-A orifice area > P-A spool stroke • Spool position at maximum P-B orifice area < -P-B spool stroke • Spool position at maximum B-T orifice area > B-T spool stroke • Spool position at maximum P-T orifice area = any value

Valve Orifice Parameterizations

The **Orifice parameterization** parameter sets the model for the open area or volumetric flow rate through one or all of the valve orifices. The block applies the same data for all flow paths if **Area characteristics** is set to **Identical** for all flow paths; otherwise, individual parameterizations are applied for the **Different** for all flow paths setting. You can model valve opening in three ways:

- Linear - area vs. spool travel

The opening area is a linear function of the spool position received as a signal at port **S**:

$$A_{orifice} = \frac{(A_{max} - A_{leak})}{\Delta S_{max}} \Delta S + A_{leak},$$

where:

- ΔS is the spool travel defined in Orifice Definition and Spool Travel Direction.
- ΔS_{max} is the **Spool travel between closed and open orifice**.
- A_{max} is the **Maximum orifice area**.
- A_{leak} is the **Leakage area**.

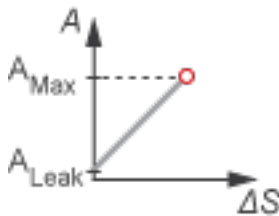

- Tabulated data - Area vs. spool travel

Provide spool travel vectors for your system or for individual flow paths between ports **P**, **A**, **B**, and **T**. This data will be used to calculate the relationship between the orifice area and spool displacement. Interpolation is used to determine the opening area between given data points. A_{leak} and A_{max} are the first and last parameters of the opening area vector, respectively.

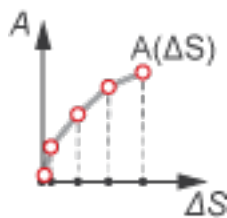

- Tabulated data - Volumetric flow rate vs. spool travel and pressure drop

Provide spool travel and pressure drop vectors and a dependent, 2-D volumetric flow rate array. Interpolation is used to determine flow rate between given data points. The mass flow rate is the product of the volumetric flow rate and the local density.

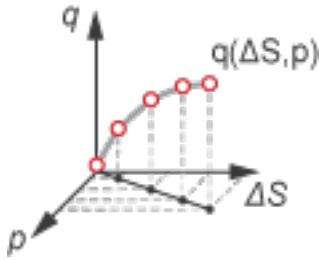

Numerically-Smoothed Valve Area in the Linear Parameterization

When the valve is in a near-open or near-closed position in the linear parameterization, you can maintain numerical robustness in your simulation by adjusting the block **Smoothing factor**. A smoothing function is applied to all calculated areas, but primarily influences the simulation at the extremes of the valve area.

The normalized valve area is calculated as:

$$\hat{A} = \frac{(A_{orifice} - A_{leak})}{(A_{max} - A_{leak})}.$$

The **Smoothing factor**, s , is applied to the normalized area:

$$\hat{A}_{smoothed} = \frac{1}{2} + \frac{1}{2} \sqrt{\hat{A}^2 + \left(\frac{s}{4}\right)^2} - \frac{1}{2} \sqrt{(\hat{A} - 1)^2 + \left(\frac{s}{4}\right)^2}.$$

The smoothed valve area is:

$$A_{smoothed} = \hat{A}_{smoothed}(A_{max} - A_{leak}) + A_{leak}.$$

Visualize Orifice Openings

To visualize spool offsets and maximum displacement, right-click on the block and select **Fluids > Plot Valve Characteristics**. The plot shows the orifices selected in the **Valve Configuration** tab settings. The axes are set by the orifice parameterization selection and are either:

- Orifice Area vs. Spool Position
- Volumetric Flow Rate vs. Spool Position, queried at a specific pressure differential

When the positive, neutral, and negative settings in the **Valve Configuration** tab feature the same orifice, the orifice opening is displayed as a constant.

Each time you modify the block settings, click **Apply** at the bottom of the dialog box, then click **Reload Data** on the figure window.

The image below shows an example valve configuration. On the **Valve Configuration** tab:

- **Positive spool position open connections** is set to P-A and B-T.
- **Neutral spool position open connections** is set to P-T only.
- **Negative spool position open connections** is set to P-B and A-T.

On the P-A Orifice tab:

- **Spool position at maximum P-A orifice area** is set to 2.5×10^{-3} m.

All other spool positions are at the default values.

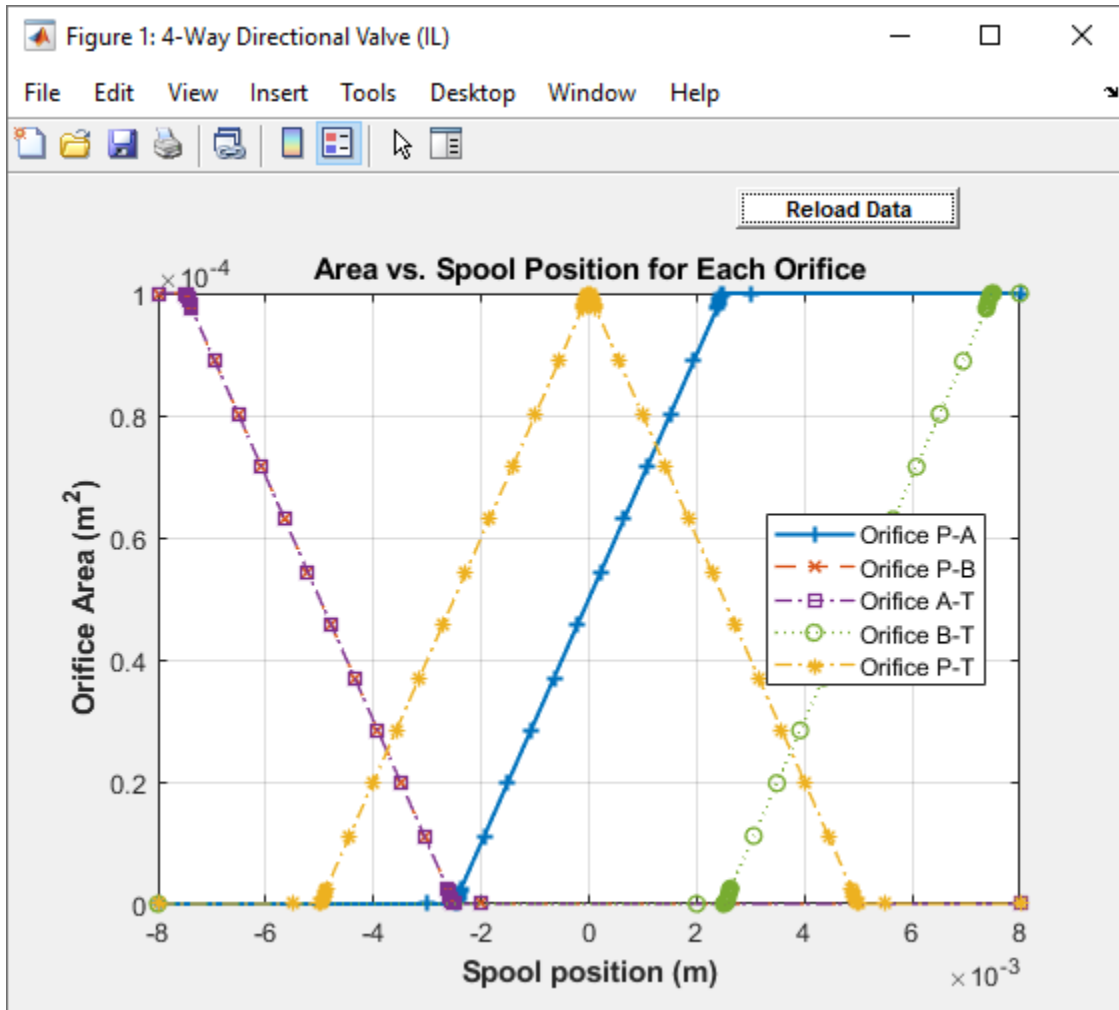

Example Spool Position Visualization

The visualization shows that the P-A orifice is open between the spool position at -2.53×10^{-3} and 2.53×10^{-3} m. Due to the specification that the P-A orifice is open only when the spool is displaced in the positive direction, the **Consistency check for neutral spool and position open connections** set to Warning returns:

Warning: P-A orifice must be closed when the spool is in the neutral position. Adjust Spool position at maximum P-A orifice area, Neutral spool position open connections, or Consistency check for neutral spool position open connections. Right-click on the block and select Fluids > Plot Valve Characteristics to view the area or flow of each connection versus spool position.

To resolve this warning, you can:

- Change the **Spool position at maximum P-A orifice area** to a value larger than 0.005 m.
- Change **Consistency check for neutral spool position open connections** to None.
- Change the valve configuration by setting **Neutral spool position open connections** to P-A only.

Faulty Behavior

When faults are enabled, the valve open area becomes stuck at a specified spool position in response to one of these triggers:

- Simulation time — Faulting occurs at a specified time.
- Simulation behavior — Faulting occurs in response to an external trigger. This exposes port **Tr**.

Four fault options are available in the **Spool position when faulted** parameter:

- **Positive** — The spool position freezes in the positive position, opening the **Positive spool position open connections** flow paths to their maximum value. The flow paths that are only open in the **Negative spool position open connections** and **Neutral spool position open connections** are closed.
- **Neutral** — The spool position freezes in the neutral position, opening all flow paths to their specified values at 0 m.
- **Negative** — The spool position freezes in the negative position, opening the **Negative spool position open connections** flow paths to their maximum value. The flow paths that are only open in the **Positive spool position open connections** and **Neutral spool position open connections** are closed.
- **Maintain last value** — The valve freezes at the spool position when the trigger occurs.

Due to numerical smoothing at the extremes of the valve area, in the linear parameterization, the minimum area applied is larger than the **Leakage area**, and the maximum is smaller than the **Maximum orifice area**, in proportion to the **Smoothing factor** value.

Once triggered, the valve remains at the faulted area for the rest of the simulation.

Predefined Parameterization

Pre-parameterization of the 4-Way 3-Position Directional Valve (IL) block with manufacturer data is available. This data allows you to model a specific supplier component.

To load a predefined parameterization,

- 1 Click the "Select a predefined parameterization" hyperlink in the 4-Way 3-Position Directional Valve (IL) block dialog description.
- 2 Select a part from the drop-down menu and click **Update block with selected part**.
- 3 If you change any parameter settings after loading a parameterization, you can check your changes by clicking **Compare block settings with selected part**. Any difference in settings between the block and pre-defined parameterization will display in the MATLAB command window.

Note that it is not possible to set different values for the same orifice for both positive and negative displacement of the control member. Additionally, the opening area is mirrored around the neutral position.

Note Predefined parameterizations of Simscape components use available data sources for supplying parameter values. Engineering judgement and simplifying assumptions are used to fill in for missing data. As a result, deviations between simulated and actual physical behavior should be expected. To ensure requisite accuracy, you should validate simulated behavior against experimental data and refine component models as necessary.

Ports

Conserving

A — Liquid port

isothermal liquid

Liquid entry or exit port to the valve.

B — Liquid port

isothermal liquid

Liquid entry or exit port to the valve.

P — Liquid port

isothermal liquid

Liquid entry or exit port to the valve.

T — Liquid port

isothermal liquid

Liquid entry or exit port to the valve.

Input

S — Spool displacement, m

physical signal

Spool displacement, in m, specified as a physical signal.

Tr — External fault trigger

physical signal

Physical signal port for an external fault trigger. Triggering occurs when the value is greater than 0.5. There is no unit associated with the trigger value.

Dependencies

This port is visible when **Enable faults** is set to On and **Fault trigger** is set to External.

Parameters

Valve Configuration

Positive spool position open connections — Flow paths open when the spool is in a positive position

P-A and B-T (default) | P-A and P-B | P-B and A-T | P-A only | P-B only

Flow paths open when the spool is in a positive position. This parameter sets the valve configuration and defines the direction of spool movement according to the signal received at port **S**. The settings for this parameter can be checked against the definitions for the other orifices for consistency when the **Consistency check for neutral spool position open connections** is set to Warning or Error.

Neutral spool position open connections – Flow paths open when the spool is in the neutral position

All closed (default) | P-A, P-B, A-T, and P-B | A-T and B-T | P-A and A-T | P-A and B-T | P-A and P-B | P-B and A-T | P-B and B-T | A-T only | B-T only | P-A only | P-B only | P-T only

Flow paths open when the spool is in the neutral position. This parameter sets the valve configuration and defines the direction of spool movement according to the signal received at port **S**. The settings for this parameter can be checked against the definitions for the other orifices for consistency when the **Consistency check for neutral spool position open connections** is set to Warning or Error.

Negative spool position open connections – Flow paths open when the spool moves in the negative direction

P-B and A-T (default) | P-A and B-T | P-A and P-B | P-A only | P-B only

Flow paths open when the spool moves in the negative direction. This parameter sets the valve configuration and defines the direction of spool movement according to the signal received at port **S**. The settings for this parameter can be checked against the definitions for the other orifices for consistency when the **Consistency check for neutral spool position open connections** is set to Warning or Error.

Consistency check for neutral spool position open connections – Whether to check if the orifice settings are consistent with the specified spool position for maximum orifice opening

Warning (default) | Error | None

Whether to check if the neutral spool position open settings on the **Valve Configuration** tab are consistent with the specified spool position at the maximum orifice area. For each enabled orifice, the actual offset at the spool neutral position should be commensurate with the specified spool offset for each individual orifice.

Model Parameterization

Area characteristics – Flow equations for orifices

Identical for all flow paths (default) | Different for each flow path

Applies uniform or individual flow equations for the valve orifice area. Identical for all flow paths uses the same orifice and spool geometries, flow rates, pressure, and area vectors for all valve orifices. When using Different for each flow path, these parameters are specified individually for each orifice. In both cases, orifices **A**, **B**, **P**, and **T** have the same cross-sectional areas, discharge coefficients, and Reynolds numbers in the Linear - Area vs. spool travel and Tabulated data - Area vs. spool travel parameterizations. The same **Orifice parameterization** is applied to all flow paths.

Orifice parameterization – Method of calculating opening area

Linear area vs. spool travel (default) | Tabulated data - Area vs. spool travel | Tabulated data - Volumetric flow rate vs. spool travel and pressure drop

Method of calculating the valve opening area. In the tabulated data parameterizations, you can provide your own valve area and spool travel data for nonlinear valve opening profiles, or you can provide data in terms of volumetric flow rate, spool travel, and pressure drop over the flow path.

Spool travel between closed and open orifice – Maximum spool stroke

0.005 m (default) | positive scalar

Maximum distance of spool travel.

Dependencies

To enable this parameter, set **Area characteristics** to Identical for all flow paths and **Orifice parameterization** to Linear - Area vs. spool travel.

Maximum orifice area – Maximum orifice opening area

1e-4 m² (default) | positive scalar

Largest open area of each orifice during the operation of the valve.

Dependencies

To enable this parameter, set **Area characteristics** to Identical for all flow paths and **Orifice parameterization** to Linear - Area vs. spool travel.

Leakage area – Open area when an orifice is fully closed

1e-9 m² (default) | positive scalar

Open area when an orifice is fully closed. Any area smaller than this value is maintained at the specified leakage area. This parameter contributes to numerical stability by maintaining continuity in the flow.

Dependencies

To enable this parameter, set **Orifice parameterization** to Linear - Area vs. spool travel.

Spool travel vector – Vector of spool opening distances relative to fully closed position

[0, .00125, .0025, .00375, .005] m (default) | 1-by-n vector

Vector of spool travel distances for the tabular parameterization of valve area. The vector elements must correspond one-to-one with the elements in the **Orifice area vector** parameter. The values are listed in ascending order and the first element must be 0. Linear interpolation is employed between table data points.

Dependencies

To enable this parameter, set **Area characteristics** to Identical for all flow paths and **Orifice parameterization** to Tabulated data - Area vs. spool travel.

Orifice area vector – Vector of valve opening areas

[1e-09, 1e-05, 4e-05, 6e-05, .0001] m² (default) | 1-by-n vector

Vector of opening areas for the tabular parameterization of valve opening area. The vector elements must correspond one-to-one with the elements in the **Spool travel vector** parameter. The elements are listed in ascending order and must be greater than 0.

Dependencies

To enable this parameter, set **Area characteristics** to Identical for all flow paths and **Orifice parameterization** to Tabulated data - Area vs. spool travel.

Spool travel vector, ds — Vector of spool opening distances relative to fully closed position

[0, .00125, .0025, .00375, .005] m (default) | 1-by-*n* vector

Vector of spool travel distances for the tabular parametrization of volumetric flow rate. The spool travel vector forms an independent axis with the **Pressure drop vector, dp** parameter for the 2-D dependent **Volumetric flow rate table, q(ds,dp)** parameter. The values are listed in ascending order and the first element must be 0. Linear interpolation is employed between table data points.

Dependencies

To enable this parameter, set **Area characteristics** to Identical for all flow paths and **Orifice parameterization** to Tabulated data - Volumetric flow rate vs. spool travel and pressure drop.

Pressure drop vector, dp — Vector of valve pressure drop values

[-.1, .3, .5, .7] MPa (default) | 1-by-*n* vector

Vector of pressure drop values for the tabular parametrization of volumetric flow rate. The pressure drop vector forms an independent axis with the **Spool travel vector, ds** parameter for the 2-D dependent **Volumetric flow rate table, q(ds,dp)** parameter. The values are listed in ascending order and must be greater than 0. Linear interpolation is employed between table data points.

Dependencies

To enable this parameter, set **Area characteristics** to Identical for all flow paths and **Orifice parameterization** to Tabulated data - Volumetric flow rate vs. spool travel and pressure drop.

Volumetric flow rate table, q(ds,dp) — Array of volumetric flow rates

[-1e-08, 2.2e-08, 2.8e-08, 3.4e-08; -9e-06, .00015, .0002, .00024;
-.00036, .00063, .00081, .00096; .00054, .00094, .0012, .0014;
-.00091, .0016, .002, .0024] m³/s (default) | *M*-by-*N* matrix

M-by-*N* matrix of volumetric flow rates based on independent values of pressure drop and spool travel distance. *M* and *N* are the sizes of the correlated vectors:

- *M* is the number of vector elements in the **Pressure drop vector, dp** parameter.
- *N* is the number of vector elements in the **Spool travel vector, ds** parameter.

Dependencies

To enable this parameter, set **Area characteristics** to Identical for all flow paths and **Orifice parameterization** to Tabulated data - Volumetric flow rate vs. spool travel and pressure drop.

Constant orifice area — Orifice area for identical flow paths

1e-4 m² (default) | positive scalar

Orifice area when the positive, neutral, and negative spool positions feature the same orifice.

Dependencies

To enable this parameter, set **Area characteristics** to Identical for all flow paths and **Orifice parameterization** to either:

- Linear - area vs. spool travel.
- Tabulated data - Area vs. spool travel

The same orifice must be selected in all three of the **Valve Configuration** parameters:

- **Positive spool position open connections**
- **Neutral spool position open connections**
- **Negative spool position open connections**

Constant orifice pressure drop vector – Vector of pressure differential values for identical flow paths

[-.1, .3, .5, .7] MPa (default) | 1-by-*n* vector

Vector of pressure differential values over the valve when the positive, neutral, and negative spool positions feature the same orifice. The vector elements correspond one-to-one with the elements in the **Constant orifice volumetric flow rate vector** parameter. The values are listed in ascending order. Linear interpolation is employed between table data points.

Dependencies

To enable this parameter, set **Area characteristics** to Identical for all flow paths and **Orifice parameterization** to Tabulated data - Volumetric flow rate vs. spool travel and pressure drop.

The same orifice must be selected in all three of the **Valve Configuration** parameters:

- **Positive spool position open connections**
- **Neutral spool position open connections**
- **Negative spool position open connections**

Constant orifice volumetric flow rate vector – Vector of volumetric flow rate values for identical flow paths

[-.0009, .0016, .002, .0024] m³/s (default) | 1-by-*n* vector

Vector of volumetric flow rate values for a constant orifice when the positive, neutral, and negative spool positions feature the same orifice. The vector elements correspond one-to-one with the elements in the **Constant orifice pressure drop vector** parameter. The values are listed in ascending order. Linear interpolation is employed between table data points.

Dependencies

To enable this parameter, set **Area characteristics** to Identical for all flow paths and **Orifice parameterization** to Tabulated data - Volumetric flow rate vs. spool travel and pressure drop.

The same orifice must be selected in all three of the **Valve Configuration** parameters:

- **Positive spool position open connections**
- **Neutral spool position open connections**

- **Negative spool position open connections**

Cross-sectional area at ports P, T, A and B – Area at conserving ports

inf m² (default) | positive scalar

Maximum cross-sectional areas at the entry and exit ports **P**, **T**, **A**, and **B**, which are used in the pressure-flow rate equation that determines the mass flow rate through the valve.

Dependencies

To enable this parameter, set **Area characteristics** to Identical for all flow paths and **Orifice parameterization** to either:

- Linear - area vs. spool travel
- Tabulated data - Area vs. spool travel

Discharge coefficient – Discharge coefficient

0.64 (default) | positive scalar

Correction factor that accounts for discharge losses in theoretical flows.

Dependencies

To enable this parameter, set **Orifice parameterization** to either:

- Linear - Area vs. spool travel
- Tabulated data - Area vs. spool travel

Critical Reynolds number – Upper Reynolds number limit for laminar flow

150 (default) | positive scalar

Upper Reynolds number limit for laminar flow through the orifice.

Dependencies

To enable this parameter, set **Orifice parameterization** to:

- Linear - area vs. spool travel
- Tabulated data - Area vs. spool travel

Smoothing factor – Numerical smoothing factor

0.01 (default) | positive scalar in the range of [0,1]

Continuous smoothing factor that introduces a layer of gradual change based to the flow response when the valve is in near-open and near-closed positions. To increase the stability of your simulation in these regimes, set this parameter to a nonzero value less than one.

Dependencies

To enable this parameter, set **Orifice parametrization** to Linear - area vs. spool travel.

Pressure recovery – Whether to account for pressure increase in area expansions

Off (default) | On

Whether to account for pressure increase when fluid flows from a region of smaller cross-sectional area to a region of larger cross-sectional area.

Dependencies

To enable this parameter, set **Orifice parameterization** to:

- Linear - area vs. spool travel
- Tabulated data - Area vs. spool travel

P-A Orifice**Spool position at maximum P-A orifice area — Spool offset for fully open P-A orifice**

7.5e-3 m (default) | positive scalar

Spool offset from the neutral position for a fully open P-A orifice. The **Consistency check for neutral spool position open connections** parameter will notify you if the values set for this spool position are inconsistent or unphysical according to other orifice spool positions. To visualize the defined offsets, see “Visualize Orifice Openings” on page 1-209.

Dependencies

To enable this parameter, set one of the following parameters:

Positive spool position open connections to:

- P-A and B-T
- P-A and P-B
- P-A only

Neutral spool position open connections to:

- P-A, P-B, A-T, and B-T
- P-A and A-T
- P-A and B-T
- P-A and P-B
- P-A only

Negative spool position open connections to:

- P-A, P-B, A-T, and B-T
- P-A and A-T
- P-A and B-T
- P-A and P-B
- P-A only

Note: This parameter is enabled only when the P-A orifice settings do not appear in all three spool position parameters: **Positive spool position open connections**, **Neutral spool position open connections**, and **Negative spool position open connections**.

P-A spool travel between closed and open orifice — Maximum spool stroke

0.005 m (default) | positive scalar

Maximum distance of spool travel. This value provides an upper limit to calculations so that simulations do not return unphysical values.

Dependencies

To enable this parameter, set:

- 1 **Area characteristics** to Different for each flow path.
- 2 **Orifice parameterization** to Linear - Area vs. spool travel.
- 3 One of the following parameters:

Positive spool position open connections to:

- P-A and B-T
- P-A and P-B
- P-A only

Neutral spool position open connections to:

- P-A, P-B, A-T, and B-T
- P-A and A-T
- P-A and B-T
- P-A and P-B
- P-A only

Negative spool position open connections to:

- P-A, P-B, A-T, and B-T
- P-A and A-T
- P-A and B-T
- P-A and P-B
- P-A only

P-A maximum orifice area — Maximum orifice opening area

$1e-4 \text{ m}^2$ (default) | positive scalar

Largest open area of the P-A orifice during the operation of the valve.

Dependencies

To enable this parameter, set:

- 1 **Area characteristics** to Different for each flow path.
- 2 **Orifice parameterization** to Linear - Area vs. spool travel.
- 3 One of the following parameters:

Positive spool position open connections to:

- P-A and B-T
- P-A and P-B

- P-A only

Neutral spool position open connections to:

- P-A, P-B, A-T, and B-T
- P-A and A-T
- P-A and B-T
- P-A and P-B
- P-A only

Negative spool position open connections to:

- P-A, P-B, A-T, and B-T
- P-A and A-T
- P-A and B-T
- P-A and P-B
- P-A only

P-A orifice spool travel vector – Vector of spool opening distances relative to fully closed position

[0, .00125, .0025, .00375, .005] m (default) | 1-by-*n* vector

Vector of spool travel distances for the tabular parameterization of valve area. The vector elements must correspond one-to-one with the elements in the **P-A orifice area vector** parameter. The values are listed in ascending order and the first element must be 0. Linear interpolation is employed between table data points.

Dependencies

To enable this parameter, set:

- 1 Area characteristics** to Different for each flow path.
- 2 Orifice parameterization** to Tabulated data - Area vs. spool travel.
- 3** One of the following parameters:

Positive spool position open connections to:

- P-A and B-T
- P-A and P-B
- P-A only

Neutral spool position open connections to:

- P-A, P-B, A-T, and B-T
- P-A and A-T
- P-A and B-T
- P-A and P-B
- P-A only

Negative spool position open connections to:

- P-A, P-B, A-T, and B-T
- P-A and A-T
- P-A and B-T
- P-A and P-B
- P-A only

P-A orifice area vector — Vector of valve opening areas

[1e-10, 1e-05, 4e-05, 6e-05, .0001] m² (default) | 1-by-*n* vector

Vector of opening areas for the tabular parameterization of valve opening area. The vector elements must correspond one-to-one with the elements in the **P-A spool travel vector** parameter. The elements are listed in ascending order and must be greater than 0.

Dependencies

To enable this parameter, set:

- 1 Area characteristics** to Different for each flow path.
- 2 Orifice parameterization** to Tabulated data - Area vs. spool travel.
- 3** One of the following parameters:

Positive spool position open connections to:

- P-A and B-T
- P-A and P-B
- P-A only

Neutral spool position open connections to:

- P-A, P-B, A-T, and B-T
- P-A and A-T
- P-A and B-T
- P-A and P-B
- P-A only

Negative spool position open connections to:

- P-A, P-B, A-T, and B-T
- P-A and A-T
- P-A and B-T
- P-A and P-B
- P-A only

P-A orifice spool travel vector, ds — Vector of spool opening distances relative to fully closed position

[0, .00125, .0025, .00375, .005] m (default) | 1-by-*n* vector

Vector of spool travel distances for the tabular parameterization of volumetric flow rates. The spool travel vector forms an independent axis with the **P-A orifice pressure drop vector, dp** parameter for the 2-D dependent **P-A orifice volumetric flow rate table, q(ds,dp)** parameter. The values are

listed in ascending order and the first element must be 0. Linear interpolation is employed between table data points.

Dependencies

To enable this parameter, set:

- 1 Area characteristics** to Different for each flow path.
- 2 Orifice parameterization** to Tabulated data - Volumetric flow rate vs. spool travel and pressure drop.
- 3** One of the following parameters:

Positive spool position open connections to:

- P-A and B-T
- P-A and P-B
- P-A only

Neutral spool position open connections to:

- P-A, P-B, A-T, and B-T
- P-A and A-T
- P-A and B-T
- P-A and P-B
- P-A only

Negative spool position open connections to:

- P-A, P-B, A-T, and B-T
- P-A and A-T
- P-A and B-T
- P-A and P-B
- P-A only

P-A orifice pressure drop vector, dp — Vector of pressure drop values

[-.1, .3, .5, .7] MPa (default) | 1-by- n vector

Vector of pressure drop values for the tabular parametrization of volumetric flow rate. The pressure drop vector forms an independent axis with the **P-A orifice spool travel vector, ds** parameter for the 2-D dependent **P-A orifice volumetric flow rate table, $q(ds,dp)$** parameter. The values are listed in ascending order and must be greater than 0. Linear interpolation is employed between table data points.

Dependencies

To enable this parameter, set:

- 1 Area characteristics** to Different for each flow path.
- 2 Orifice parameterization** to Tabulated data - Volumetric flow rate vs. spool travel and pressure drop.
- 3** One of the following parameters:

Positive spool position open connections to:

- P-A and B-T
- P-A and P-B
- P-A only

Neutral spool position open connections to:

- P-A, P-B, A-T, and B-T
- P-A and A-T
- P-A and B-T
- P-A and P-B
- P-A only

Negative spool position open connections to:

- P-A, P-B, A-T, and B-T
- P-A and A-T
- P-A and B-T
- P-A and P-B
- P-A only

P-A orifice volumetric flow rate table, $q(ds, dp)$ — Array of volumetric flow rate values

$[-1e-08, 2.2e-08, 2.8e-08, 3.4e-08; -9e-06, .00015, .0002, .00024; -.00036, .00063, .00081, .00096; -.00054, .00094, .0012, .0014; -.00091, .0016, .002, .0024]$ m³/s (default) | *M*-by-*N* matrix

M-by-*N* matrix of volumetric flow rates based on independent values of pressure drop and spool travel distance. *M* and *N* are the sizes of the correlated vectors:

- *M* is the number of vector elements in the **P-A orifice pressure drop vector, dp** parameter.
- *N* is the number of vector elements in the **P-A orifice spool travel vector, ds** parameter.

Dependencies

To enable this parameter, set:

- 1 Area characteristics** to Different for each flow path.
- 2 Orifice parameterization** to Tabulated data - Volumetric flow rate vs. spool travel and pressure drop.
- 3** One of the following parameters:

Positive spool position open connections to:

- P-A and B-T
- P-A and P-B
- P-A only

Neutral spool position open connections to:

- P-A, P-B, A-T, and B-T
- P-A and A-T
- P-A and B-T
- P-A and P-B
- P-A only

Negative spool position open connections to:

- P-A, P-B, A-T, and B-T
- P-A and A-T
- P-A and B-T
- P-A and P-B
- P-A only

P-A constant orifice area — Cross-sectional area for a constant orifice

1e-4 m² (default) | positive scalar

Orifice area when the positive, neutral, and negative spool positions feature the same orifice.

Dependencies

To enable this parameter, set:

- 1 Area characteristics** to Different for each flow path.
- 2 Orifice parameterization** to either:
 - Linear - area vs. spool travel
 - Tabulated data - Area vs. spool travel
- 3** One of the following settings in each parameter:

Positive spool position open connections to:

- P-A and B-T
- P-A and P-B
- P-A only

Neutral spool position open connections to:

- P-A, P-B, A-T, and B-T
- P-A and A-T
- P-A and B-T
- P-A and P-B
- P-A only

Negative spool position open connections to:

- P-A, P-B, A-T, and B-T
- P-A and A-T
- P-A and B-T

- P-A and P-B
- P-A only

P-A Constant orifice pressure drop vector — Vector of pressure differential values for a constant orifice

[-.1, .3, .5, .7] MPa (default) | 1-by-*n* vector

Vector of pressure differential values over the valve when the positive, neutral, and negative spool positions feature the same orifice. The vector elements correspond one-to-one with the elements in the **P-A Constant orifice volumetric flow rate vector** parameter. The values are listed in ascending order. Linear interpolation is employed between table data points.

Dependencies

To enable this parameter, set:

- 1 Area characteristics** to Different for each flow path.
- 2 Orifice parameterization** to Tabulated data - Volumetric flow rate vs. spool travel and pressure drop.
- 3** One of the following settings in each parameter:

Positive spool position open connections to:

- P-A and B-T
- P-A and P-B
- P-A only

Neutral spool position open connections to:

- P-A, P-B, A-T, and B-T
- P-A and A-T
- P-A and B-T
- P-A and P-B
- P-A only

Negative spool position open connections to:

- P-A, P-B, A-T, and B-T
- P-A and A-T
- P-A and B-T
- P-A and P-B
- P-A only

P-A Constant orifice volumetric flow rate vector — Vector of volumetric flow rates for a constant orifice

[-.0009, .0016, .002, .0024] m³/s (default) | 1-by-*n* vector

Vector of pressure differential values over the valve when the positive, neutral, and negative spool positions feature the same orifice. The vector elements correspond one-to-one with the elements in the **P-A Constant orifice pressure drop vector** parameter. The values are listed in ascending order. Linear interpolation is employed between table data points.

Dependencies

To enable this parameter, set:

- 1 Area characteristics** to Different for each flow path.
- 2 Orifice parameterization** to Tabulated data - Volumetric flow rate vs. spool travel and pressure drop.
- 3** One of the following settings in each parameter:

Positive spool position open connections to:

- P-A and B-T
- P-A and P-B
- P-A only

Neutral spool position open connections to:

- P-A, P-B, A-T, and B-T
- P-A and A-T
- P-A and B-T
- P-A and P-B
- P-A only

Negative spool position open connections to:

- P-A, P-B, A-T, and B-T
- P-A and A-T
- P-A and B-T
- P-A and P-B
- P-A only

P-B Orifice**Spool position at maximum P-B orifice area — Spool offset from the neutral position for a fully open P-B orifice**

7.5e-3 m (default) | positive scalar

Spool offset from the neutral position for a fully open P-B orifice. The **Consistency check for neutral spool position open connections** parameter will notify you if the values set for this spool position are inconsistent or unphysical according to other orifice spool positions. To visualize the defined offsets, see “Visualize Orifice Openings” on page 1-209.

Dependencies

To enable this parameter, set one of the following parameters:

Positive spool position open connections to:

- P-B and A-T
- P-A and P-B
- P-B only

Neutral spool position open connections to:

- P-A, P-B, A-T, and B-T
- P-B and A-T
- P-B and B-T
- P-A and P-B
- P-B only

Negative spool position open connections to:

- P-A, P-B, A-T, and B-T
- P-B and A-T
- P-B and B-T
- P-A and P-B
- P-B only

Note: This parameter is enabled only when the P-B orifice settings do not appear in all three spool position parameters: **Positive spool position open connections**, **Neutral spool position open connections**, and **Negative spool position open connections**.

P-B spool travel between closed and open orifice — Maximum spool stroke

0.005 m (default) | positive scalar

Maximum distance of spool travel. This value provides an upper limit to calculations so that simulations do not return unphysical values.

Dependencies

To enable this parameter, set:

- 1 **Area characteristics** to Different for each flow path.
- 2 **Orifice parameterization** to Linear - Area vs. spool travel.
- 3 One of the following parameters:

Positive spool position open connections to:

- P-B and A-T
- P-A and P-B
- P-B only

or set **Neutral spool position open connections to:**

- P-A, P-B, A-T, and B-T
- P-B and A-T
- P-B and B-T
- P-A and P-B
- P-B only

or set **Negative spool position open connections to:**

- P-A, P-B, A-T, and B-T
- P-B and A-T
- P-B and B-T
- P-A and P-B
- P-B only

P-B maximum orifice area — Maximum orifice opening area

1e-4 m² (default) | positive scalar

Largest open area of the P-B orifice during the operation of the valve.

Dependencies

To enable this parameter, set:

- 1 Area characteristics** to Different for each flow path.
- 2 Orifice parameterization** to Linear - Area vs. spool travel.
- 3** One of the following parameters:

Positive spool position open connections to:

- P-B and A-T
- P-A and P-B
- P-B only

Neutral spool position open connections to:

- P-A, P-B, A-T, and B-T
- P-B and A-T
- P-B and B-T
- P-A and P-B
- P-B only

Negative spool position open connections to:

- P-A, P-B, A-T, and B-T
- P-B and A-T
- P-B and B-T
- P-A and P-B
- P-B only

P-B orifice spool travel vector — Vector of spool opening distances relative to fully closed position

[0, .00125, .0025, .00375, .005] m (default) | 1-by-*n* vector

Vector of spool travel distances for the tabular parameterization of valve area. The vector elements must correspond one-to-one with the elements in the **P-B orifice area vector** parameter. The values are listed in ascending order and the first element must be 0. Linear interpolation is employed between table data points.

Dependencies

To enable this parameter, set:

- 1 **Area characteristics** to Different for each flow path.
- 2 **Orifice parameterization** to Tabulated data - Area vs. spool travel.
- 3 One of the following parameters:

Positive spool position open connections to:

- P-B and A-T
- P-A and P-B
- P-B only

Neutral spool position open connections to:

- P-A, P-B, A-T, and B-T
- P-B and A-T
- P-B and B-T
- P-A and P-B
- P-B only

Negative spool position open connections to:

- P-A, P-B, A-T, and B-T
- P-B and A-T
- P-B and B-T
- P-A and P-B
- P-B only

P-B orifice area vector — Vector of valve opening areas

[1e-10, 1e-05, 4e-05, 6e-05, .0001] m² (default) | 1-by-*n* vector

Vector of opening areas for the tabular parameterization of valve opening area. The vector elements must correspond one-to-one with the elements in the **P-B spool travel vector** parameter. The elements are listed in ascending order and must be greater than 0.

Dependencies

To enable this parameter, set:

- 1 **Area characteristics** to Different for each flow path.
- 2 **Orifice parameterization** to Tabulated data - Area vs. spool travel.
- 3 One of the following parameters:

Positive spool position open connections to:

- P-B and A-T
- P-A and P-B
- P-B only

Neutral spool position open connections to:

- P-A, P-B, A-T, and B-T
- P-B and A-T
- P-B and B-T
- P-A and P-B
- P-B only

Negative spool position open connections to:

- P-A, P-B, A-T, and B-T
- P-B and A-T
- P-B and B-T
- P-A and P-B
- P-B only

P-B orifice spool travel vector, ds — Vector of spool opening distances relative to fully closed position

[0, .00125, .0025, .00375, .005] m (default) | 1-by-n vector

Vector of spool travel distances for the tabular parameterization of volumetric flow rates. The spool travel vector forms an independent axis with the **P-T orifice pressure drop vector, dp** parameter for the 2-D dependent **P-T orifice volumetric flow rate table, q(ds,dp)** parameter. The values are listed in ascending order and the first element must be 0. Linear interpolation is employed between table data points.

Dependencies

To enable this parameter, set:

- 1 Area characteristics** to Different for each flow path.
- 2 Orifice parameterization** to Tabulated data - Volumetric flow rate vs. spool travel and pressure drop.
- 3** One of the following parameters:

Positive spool position open connections to:

- P-B and A-T
- P-A and P-B
- P-B only

Neutral spool position open connections to:

- P-A, P-B, A-T, and B-T
- P-B and A-T
- P-B and B-T
- P-A and P-B
- P-B only.

Negative spool position open connections to:

- P-A, P-B, A-T, and B-T
- P-B and A-T
- P-B and B-T
- P-A and P-B
- P-B only

P-B orifice pressure drop vector, dp — Vector of pressure differential values

[-.1, .3, .5, .7] MPa (default) | 1-by-n vector

Vector of pressure drop values for tabular parametrization of volumetric flow rate. The pressure drop vector forms an independent axis with the **P-B orifice spool travel vector, ds** parameter for the 2-D dependent **P-B orifice volumetric flow rate table, $q(ds,dp)$** parameter. The values are listed in ascending order and must be greater than 0. Linear interpolation is employed between table data points.

Dependencies

To enable this parameter, set:

- 1 Area characteristics** to Different for each flow path.
- 2 Orifice parameterization** to Tabulated data - Volumetric flow rate vs. spool travel and pressure drop.
- 3** One of the following parameters:

Positive spool position open connections to:

- P-B and A-T
- P-A and P-B
- P-B only

Neutral spool position open connections to:

- P-A, P-B, A-T, and B-T
- P-B and A-T
- P-B and B-T
- P-A and P-B
- P-B only

Negative spool position open connections to:

- P-A, P-B, A-T, and B-T
- P-B and A-T
- P-B and B-T
- P-A and P-B
- P-B only

P-B orifice volumetric flow rate table, $q(ds, dp)$ — Array of volumetric flow rate values

```
[-1e-08, 2.2e-08, 2.8e-08, 3.4e-08; -9e-06, .00015, .0002, .00024;
-.00036, .00063, .00081, .00096; -.00054, .00094, .0012, .0014;
-.00091, .0016, .002, .0024] m3/s (default) | M-by-N matrix
```

M-by-N matrix of volumetric flow rates based on independent values of pressure drop and spool travel distance. M and N are the sizes of the correlated vectors:

- M is the number of vector elements in the **P-B orifice pressure drop vector, dp** parameter.
- N is the number of vector elements in the **P-B orifice spool travel vector, ds** parameter.

Dependencies

To enable this parameter, set:

- 1 **Area characteristics** to Different for each flow path.
- 2 **Orifice parameterization** to Tabulated data - Volumetric flow rate vs. spool travel and pressure drop.
- 3 One of the following parameters:

Positive spool position open connections to:

- P-B and A-T
- P-A and P-B
- P-B only

Neutral spool position open connections to:

- P-A, P-B, A-T, and B-T
- P-B and A-T
- P-B and B-T
- P-A and P-B
- P-B only

Negative spool position open connections to:

- P-A, P-B, A-T, and B-T
- P-B and A-T
- P-B and B-T
- P-A and P-B
- P-B only

P-B constant orifice area — Cross-sectional area for a constant orifice

```
1e-4 m2 (default) | positive scalar
```

Orifice area when the positive, neutral, and negative spool positions feature the same orifice.

Dependencies

To enable this parameter, set:

- 1 **Area characteristics** to Different for each flow path.
- 2 **Orifice parameterization** to either:
 - Linear - area vs. spool travel
 - Tabulated data - Area vs. spool travel
- 3 One of the following settings in each parameter:

Positive spool position open connections to:

- P-B and A-T
- P-A and P-B
- P-B only

Neutral spool position open connections to:

- P-A, P-B, A-T, and B-T
- P-B and A-T
- P-B and B-T
- P-A and P-B
- P-B only

Negative spool position open connections to:

- P-A, P-B, A-T, and B-T
- P-B and A-T
- P-B and B-T
- P-A and P-B
- P-B only

P-B Constant orifice pressure drop vector — Vector of pressure differential values for a constant orifice

[-.1, .3, .5, .7] MPa (default) | 1-by-*n* vector

Vector of pressure differential values over the valve when the positive, neutral, and negative spool positions feature the same orifice. The vector elements correspond one-to-one with the elements in the **P-B Constant orifice volumetric flow rate vector** parameter. The values are listed in ascending order. Linear interpolation is employed between table data points.

Dependencies

To enable this parameter, set:

- 1 **Area characteristics** to Different for each flow path.
- 2 **Orifice parameterization** to Tabulated data - Volumetric flow rate vs. spool travel and pressure drop.
- 3 One of the following settings in each parameter:

Positive spool position open connections to:

- P-B and A-T

- P-A and P-B
- P-B only

Neutral spool position open connections to:

- P-A, P-B, A-T, and B-T
- P-B and A-T
- P-B and B-T
- P-A and P-B
- P-B only

Negative spool position open connections to:

- P-A, P-B, A-T, and B-T
- P-B and A-T
- P-B and B-T
- P-A and P-B
- P-B only

P-B Constant orifice volumetric flow rate vector — Vector of volumetric flow rate values for a constant orifice

`[-.0009, .0016, .002, .0024]` m³/s (default) | 1-by-*n* vector

Vector of volumetric flow rate values over the valve when the positive, neutral, and negative spool positions feature the same orifice. The vector elements correspond one-to-one with the elements in the **P-B Constant orifice pressure drop vector** parameter. The values are listed in ascending order. Linear interpolation is employed between table data points.

Dependencies

To enable this parameter, set:

- 1 Area characteristics** to Different for each flow path.
- 2 Orifice parameterization** to Tabulated data - Volumetric flow rate vs. spool travel and pressure drop.
- 3** One of the following settings in each parameter:

Positive spool position open connections to:

- P-B and A-T
- P-A and P-B
- P-B only

Neutral spool position open connections to:

- P-A, P-B, A-T, and B-T
- P-B and A-T
- P-B and B-T
- P-A and P-B

- P-B only

Negative spool position open connections to:

- P-A, P-B, A-T, and B-T
- P-B and A-T
- P-B and B-T
- P-A and P-B
- P-B only

A-T Orifice

Spool position at maximum A-T orifice area — Spool offset from the neutral position for a fully open A-T orifice

7.5e-3 m (default) | positive scalar

Spool offset from the neutral position for a fully open A-T orifice. The **Consistency check for neutral spool position open connections** parameter will notify you if the values set for this spool position are inconsistent or unphysical according to other orifice spool positions. To visualize the defined offsets, see “Visualize Orifice Openings” on page 1-209.

Dependencies

To enable this parameter, set one of the following parameters:

- **Positive spool position open connections** to P-B and A-T.
- **Neutral spool position open connections** to:
 - P-A, P-B, A-T, and B-T
 - P-B and A-T
 - A-T and B-T
 - P-A and A-T
 - A-T only
- **Negative spool position open connections** to P-B and A-T.

Note: This parameter is enabled only when the A-T orifice settings do not appear in all three spool position parameters: **Positive spool position open connections**, **Neutral spool position open connections**, and **Negative spool position open connections**.

A-T spool travel between closed and open orifice — Maximum spool stroke

0.005 m (default) | positive scalar

Maximum distance of spool travel. This value provides an upper limit to calculations so that simulations do not return unphysical values.

Dependencies

To enable this parameter, set:

- 1 **Area characteristics** to Different for each flow path.

2 Orifice parameterization to Linear - Area vs. spool travel.

3 One of the following parameters:

Positive spool position open connections to P-B and A-T

Neutral spool position open connections to:

- P-A, P-B, A-T, and B-T
- P-B and A-T
- A-T and B-T
- P-A and A-T
- A-T only

Negative spool position open connections to P-B and A-T.

A-T maximum orifice area — Maximum orifice opening area

$1e-4 \text{ m}^2$ (default) | positive scalar

Largest open area of the A-T orifice during the operation of the valve.

Dependencies

To enable this parameter, set:

1 Area characteristics to Different for each flow path.

2 Orifice parameterization to Linear - Area vs. spool travel.

3 One of the following parameters:

Positive spool position open connections to P-B and A-T

Neutral spool position open connections to:

- P-A, P-B, A-T, and B-T
- P-B and A-T
- A-T and B-T
- P-A and A-T
- A-T only

Negative spool position open connections to P-B and A-T.

A-T orifice spool travel vector — Vector of spool opening distances relative to fully closed position

$[0, .00125, .0025, .00375, .005]$ m (default) | 1-by- n vector

Vector of spool travel distances for the tabular parameterization of valve area. The vector elements must correspond one-to-one with the elements in the **A-T orifice area vector** parameter. The values are listed in ascending order and the first element must be 0. Linear interpolation is employed between table data points.

Dependencies

To enable this parameter, set:

- 1 **Area characteristics** to Different for each flow path.
- 2 **Orifice parameterization** to Tabulated data - Area vs. spool travel.
- 3 One of the following parameters:

Positive spool position open connections to P-B and A-T.

Neutral spool position open connections to:

- P-A, P-B, A-T, and B-T
- P-B and A-T
- A-T and B-T
- P-A and A-T
- A-T only

Negative spool position open connections to P-B and A-T.

A-T orifice area vector – Vector of valve opening areas

[1e-10, 1e-05, 4e-05, 6e-05, .0001] m² (default) | 1-by-n vector

Vector of opening areas for the tabular parameterization of valve opening area. The vector elements must correspond one-to-one with the elements in the **A-T spool travel vector** parameter. The elements are listed in ascending order and must be greater than 0.

Dependencies

To enable this parameter, set:

- 1 **Area characteristics** to Different for each flow path.
- 2 **Orifice parameterization** to Tabulated data - Area vs. spool travel.
- 3 One of the following parameters:

Positive spool position open connections to P-B and A-T.

Neutral spool position open connections to:

- P-A, P-B, A-T, and B-T
- P-B and A-T
- A-T and B-T
- P-A and A-T
- A-T only

Negative spool position open connections to P-B and A-T.

A-T orifice spool travel vector, ds – Vector of spool opening distances relative to fully closed position

[0, .00125, .0025, .00375, .005] m (default) | 1-by-n vector

Vector of spool travel distances for the tabular parameterization of volumetric flow rates. The spool travel vector forms an independent axis with the **A-T orifice pressure drop vector, dp** parameter for the 2-D dependent **A-T orifice volumetric flow rate table, q(ds,dp)** parameter. The values are listed in ascending order and the first element must be 0. Linear interpolation is employed between table data points.

Dependencies

To enable this parameter, set:

- 1 Area characteristics** to Different for each flow path.
- 2 Orifice parameterization** to Tabulated data - Volumetric flow rate vs. spool travel and pressure drop.
- 3** One of the following parameters:

Positive spool position open connections to P-B and A-T.

Neutral spool position open connections to:

- P-A, P-B, A-T, and B-T
- P-B and A-T
- A-T and B-T
- P-A and A-T
- A-T only

Negative spool position open connections to P-B and A-T.

A-T orifice pressure drop vector, dp — Vector of pressure differential values

[-.1, .3, .5, .7] MPa (default) | 1-by- n vector

Vector of pressure drop values for tabular parametrization of volumetric flow rate. The pressure drop vector forms an independent axis with the **A-T orifice spool travel vector, ds** parameter for the 2-D dependent **A-T orifice volumetric flow rate table, $q(ds,dp)$** parameter. The values are listed in ascending order and must be greater than 0. Linear interpolation is employed between table data points.

Dependencies

To enable this parameter, set:

- 1 Area characteristics** to Different for each flow path.
- 2 Orifice parameterization** to Tabulated data - Volumetric flow rate vs. spool travel and pressure drop.
- 3** One of the following parameters:

Positive spool position open connections to P-B and A-T.

Neutral spool position open connections to:

- P-A, P-B, A-T, and B-T
- P-B and A-T
- A-T and B-T
- P-A and A-T
- A-T only

Negative spool position open connections to P-B and A-T.

A-T orifice volumetric flow rate table, $q(ds, dp)$ — Array of volumetric flow rate values

$[-1e-08, 2.2e-08, 2.8e-08, 3.4e-08; -9e-06, .00015, .0002, .00024;$
 $-.00036, .00063, .00081, .00096; -.00054, .00094, .0012, .0014;$
 $-.00091, .0016, .002, .0024]$ m³/s (default) | *M*-by-*N* matrix

M-by-*N* matrix of volumetric flow rates based on independent values of pressure drop and spool travel distance. *M* and *N* are the sizes of the correlated vectors:

- *M* is the number of vector elements in the **A-T orifice pressure drop vector, dp** parameter.
- *N* is the number of vector elements in the **A-T orifice spool travel vector, ds** parameter.

Dependencies

To enable this parameter, set:

- 1 Area characteristics** to Different for each flow path.
- 2 Orifice parameterization** to Tabulated data - Volumetric flow rate vs. spool travel and pressure drop.
- 3** One of the following parameters:

Positive spool position open connections to P-B and A-T.

Neutral spool position open connections to:

- P-A, P-B, A-T, and B-T
- P-B and A-T
- A-T and B-T
- P-A and A-T
- A-T only

Negative spool position open connections to P-B and A-T.

A-T constant orifice area — Cross-sectional area for a constant orifice

$1e-4$ m² (default) | positive scalar

Orifice area when the positive, neutral, and negative spool positions feature the same orifice.

Dependencies

To enable this parameter, set:

- 1 Area characteristics** to Different for each flow path.
- 2 Orifice parameterization** to either:
 - Linear - area vs. spool travel
 - Tabulated data - Area vs. spool travel
- 3** One of the following settings in each parameter:

Positive spool position open connections to P-B and A-T.

Neutral spool position open connections to:

- P-A, P-B, A-T, and B-T
- P-B and A-T
- A-T and B-T
- P-A and A-T
- A-T only

Negative spool position open connections to P-B and A-T.

A-T Constant orifice pressure drop vector – Vector of pressure differential values for a constant orifice

[-.1, .3, .5, .7] MPa (default) | 1-by-*n* vector

Vector of pressure differential values over the valve when the positive, neutral, and negative spool positions feature the same orifice. The vector elements correspond one-to-one with the elements in the **A-T Constant orifice volumetric flow rate vector** parameter. The values are listed in ascending order. Linear interpolation is employed between table data points.

Dependencies

To enable this parameter, set:

- 1 Area characteristics** to Different for each flow path.
- 2 Orifice parameterization** to Tabulated data - Volumetric flow rate vs. spool travel and pressure drop.
- 3** One of the following settings in each parameter:

Positive spool position open connections to P-B and A-T.

Neutral spool position open connections to:

- P-A, P-B, A-T, and B-T
- P-B and A-T
- A-T and B-T
- P-A and A-T
- A-T only

Negative spool position open connections to P-B and A-T.

A-T Constant orifice volumetric flow rate vector – Vector of volumetric flow rate values for a constant orifice

[-.0009, .0016, .002, .0024] m³/s (default) | 1-by-*n* vector

Vector of volumetric flow rate values when the positive, neutral, and negative spool positions feature the same orifice. The vector elements correspond one-to-one with the elements in the **Constant orifice volumetric flow rate vector** parameter. The values are listed in ascending order. Linear interpolation is employed between table data points.

Dependencies

To enable this parameter, set:

- 1 Area characteristics** to Different for each flow path.

- 2 **Orifice parameterization** to Tabulated data - Volumetric flow rate vs. spool travel and pressure drop.
- 3 One of the following settings in each parameter:

Positive spool position open connections to P-B and A-T.

Neutral spool position open connections to:

- P-A, P-B, A-T, and B-T
- P-B and A-T
- A-T and B-T
- P-A and A-T
- A-T only

Negative spool position open connections to P-B and A-T.

B-T Orifice

Spool position at maximum B-T orifice area — Spool offset from the neutral position for a fully open B-T orifice

7.5e-3 m (default) | positive scalar

Spool offset from the neutral position for a fully open B-T orifice. The **Consistency check for neutral spool position open connections** parameter will notify you if the values set for this spool position are inconsistent or unphysical according to other orifice spool positions. To visualize the defined offsets, see “Visualize Orifice Openings” on page 1-209.

Dependencies

To enable this parameter, set one of the following parameters:

- **Positive spool position open connections** to P-A and B-T.
- **Neutral spool position open connections** to:
 - P-A, P-B, A-T, and B-T
 - A-T and B-T
 - P-A and B-T
 - P-B and B-T
 - B-T only
- **Negative spool position open connections** to P-A and B-T.

Note: This parameter is enabled only when the B-T orifice settings do not appear in all three spool position parameters: **Positive spool position open connections**, **Neutral spool position open connections**, and **Negative spool position open connections**.

B-T spool travel between closed and open orifice — Maximum spool stroke

0.005 m (default) | positive scalar

Maximum distance of spool travel. This value provides an upper limit to calculations so that simulations do not return unphysical values.

Dependencies

To enable this parameter, set:

- 1 Area characteristics** to `Different` for each flow path.
- 2 Orifice parameterization** to `Linear - Area vs. spool travel`.
- 3** One of the following parameters:

Positive spool position open connections to P-A and B-T.

Neutral spool position open connections to:

- P-A, P-B, A-T, and B-T
- A-T and B-T
- P-A and B-T
- P-B and B-T
- B-T only

Negative spool position open connections to P-A and B-T.

B-T maximum orifice area — Maximum orifice opening area

$1e-4 \text{ m}^2$ (default) | positive scalar

Largest open area of the B-T orifice during the operation of the valve.

Dependencies

To enable this parameter, set:

- 1 Area characteristics** to `Different` for each flow path.
- 2 Orifice parameterization** to `Linear - Area vs. spool travel`.
- 3** One of the following parameters:

Positive spool position open connections to P-A and B-T.

Neutral spool position open connections to:

- P-A, P-B, A-T, and B-T
- A-T and B-T
- P-A and B-T
- P-B and B-T
- B-T only

Negative spool position open connections to P-A and B-T.

B-T orifice spool travel vector — Vector of spool opening distances relative to fully closed position

$[0, .00125, .0025, .00375, .005]$ m (default) | 1-by- n vector

Vector of spool travel distances for the tabular parameterization of valve area. The vector elements must correspond one-to-one with the elements in the **B-T orifice area vector** parameter. The values

are listed in ascending order and the first element must be 0. Linear interpolation is employed between table data points.

Dependencies

To enable this parameter, set:

- 1 **Area characteristics** to Different for each flow path.
- 2 **Orifice parameterization** to Tabulated data - Area vs. spool travel.
- 3 One of the following parameters:

Positive spool position open connections to P-A and B-T.

Neutral spool position open connections to:

- P-A, P-B, A-T, and B-T
- A-T and B-T
- P-A and B-T
- P-B and B-T
- B-T only

Negative spool position open connections to P-A and B-T.

B-T orifice area vector — Vector of valve opening areas

[1e-10, 1e-05, 4e-05, 6e-05, .0001] m² (default) | 1-by-*n* vector

Vector of opening areas for the tabular parameterization of valve opening area. The vector elements must correspond one-to-one with the elements in the **B-T orifice spool travel vector** parameter. The elements are listed in ascending order and must be greater than 0.

Dependencies

To enable this parameter, set:

- 1 **Area characteristics** to Different for each flow path.
- 2 **Orifice parameterization** to Tabulated data - Area vs. spool travel.
- 3 One of the following parameters:

Positive spool position open connections to P-A and B-T.

Neutral spool position open connections to:

- P-A, P-B, A-T, and B-T
- A-T and B-T
- P-A and B-T
- P-B and B-T
- B-T only

Negative spool position open connections to P-A and B-T.

B-T orifice spool travel vector, ds — Vector of spool opening distances relative to fully closed position

[0, .00125, .0025, .00375, .005] m (default) | 1-by-*n* vector

Vector of control member travel distances for the tabular parameterization of volumetric flow rates. The spool travel vector forms an independent axis with the **B-T orifice pressure drop vector, dp** parameter for the 2-D dependent **B-T orifice volumetric flow rate table, q(ds,dp)** parameter. The values are listed in ascending order and the first element must be 0. Linear interpolation is employed between table data points.

Dependencies

To enable this parameter, set:

- 1 **Area characteristics** to Different for each flow path.
- 2 **Orifice parameterization** to Tabulated data - Volumetric flow rate vs. spool travel and pressure drop.
- 3 One of the following parameters:

Positive spool position open connections to P-A and B-T.

Neutral spool position open connections to:

- P-A, P-B, A-T, and B-T
- A-T and B-T
- P-A and B-T
- P-B and B-T
- B-T only

Negative spool position open connections to P-A and B-T.

B-T orifice pressure drop vector, dp – Vector of pressure differential values

[-.1, .3, .5, .7] MPa (default) | 1-by-n vector

Vector of pressure drop values for tabular parametrization of volumetric flow rate. The pressure drop vector forms an independent axis with the **B-T orifice spool travel vector, ds** parameter for the 2-D dependent **B-T orifice volumetric flow rate table, q(ds,dp)** parameter. The values are listed in ascending order and must be greater than 0. Linear interpolation is employed between table data points.

Dependencies

To enable this parameter, set:

- 1 **Area characteristics** to Different for each flow path.
- 2 **Orifice parameterization** to Tabulated data - Volumetric flow rate vs. spool travel and pressure drop.
- 3 One of the following parameters:

Positive spool position open connections to P-A and B-T.

Neutral spool position open connections to:

- P-A, P-B, A-T, and B-T
- A-T and B-T
- P-A and B-T

- P-B and B-T
- B-T only

Negative spool position open connections to P-A and B-T.

B-T orifice volumetric flow rate table, $q(ds, dp)$ — Array of volumetric flow rate values

$[-1e-08, 2.2e-08, 2.8e-08, 3.4e-08; -9e-06, .00015, .0002, .00024;$
 $-.00036, .00063, .00081, .00096; -.00054, .00094, .0012, .0014;$
 $-.00091, .0016, .002, .0024]$ m³/s (default) | *M*-by-*N* matrix

M-by-*N* matrix of volumetric flow rates based on independent values of pressure drop and spool travel distance. *M* and *N* are the sizes of the correlated vectors:

- *M* is the number of vector elements in the **B-T orifice pressure drop vector, dp** parameter.
- *N* is the number of vector elements in the **B-T orifice spool travel vector, ds** parameter.

Dependencies

To enable this parameter, set:

- 1 **Area characteristics** to Different for each flow path.
- 2 **Orifice parameterization** to Tabulated data - Volumetric flow rate vs. spool travel and pressure drop.
- 3 One of the following parameters:

Positive spool position open connections to P-A and B-T.

Neutral spool position open connections to:

- P-A, P-B, A-T, and B-T
- A-T and B-T
- P-A and B-T
- P-B and B-T
- B-T only

Negative spool position open connections to P-A and B-T.

B-T constant orifice area — Cross-sectional orifice area for constant orifices

$1e-4$ m² (default) | positive scalar

Orifice area when the positive, neutral, and negative spool positions feature the same orifice.

Dependencies

To enable this parameter, set:

- 1 **Area characteristics** to Different for each flow path.
- 2 **Orifice parameterization** to either:
 - Linear - area vs. spool travel
 - Tabulated data - Area vs. spool travel

- 3** One of the settings in each parameter:

Positive spool position open connections to P-A and B-T.

Neutral spool position open connections to:

- P-A, P-B, A-T, and B-T
- A-T and B-T
- P-A and B-T
- P-B and B-T
- B-T only

Negative spool position open connections to P-A and B-T.

B-T Constant orifice pressure drop vector — Vector of pressure differential values for a constant orifice

[-.1, .3, .5, .7] MPa (default) | 1-by-*n* vector

Vector of pressure differential values over the valve when the positive, neutral, and negative spool positions feature the same orifice. The vector elements correspond one-to-one with the elements in the **B-T Constant orifice volumetric flow rate vector** parameter. The values are listed in ascending order. Linear interpolation is employed between table data points.

Dependencies

To enable this parameter, set:

- 1 Area characteristics** to Different for each flow path.
- 2 Orifice parameterization** to Tabulated data - Volumetric flow rate vs. spool travel and pressure drop.
- 3** One of the settings in each parameter:

Positive spool position open connections to P-A and B-T.

Neutral spool position open connections to:

- P-A, P-B, A-T, and B-T
- A-T and B-T
- P-A and B-T
- P-B and B-T
- B-T only

Negative spool position open connections to P-A and B-T.

B-T Constant orifice volumetric flow rate vector — Vector of volumetric flow rates for a constant orifice

[-.0009, .0016, .002, .0024] m³/s (default) | 1-by-*n* vector

Vector of pressure differential values over the valve when the positive, neutral, and negative spool positions feature the same orifice. The vector elements correspond one-to-one with the elements in the **B-T Constant orifice pressure drop vector** parameter. The values are listed in ascending order. Linear interpolation is employed between table data points.

Dependencies

To enable this parameter, set:

- 1 **Area characteristics** to Different for each flow path.
- 2 **Orifice parameterization** to Tabulated data - Volumetric flow rate vs. spool travel and pressure drop.
- 3 One of the settings in each parameter:

Positive spool position open connections to P-A and B-T.

Neutral spool position open connections to:

- P-A, P-B, A-T, and B-T
- A-T and B-T
- P-A and B-T
- P-B and B-T
- B-T only

Negative spool position open connections to P-A and B-T.

P-T Orifice**Spool position at maximum P-T orifice area — Spool offset from the neutral position for a fully open P-T orifice**

0 m (default) | positive scalar

Spool offset from the neutral position for a fully open P-T orifice. The **Consistency check for neutral spool position open connections** parameter will notify you if the values set for this spool position are inconsistent or unphysical according to other orifice spool positions. To visualize the defined offsets, see “Visualize Orifice Openings” on page 1-209.

Dependencies

To enable this parameter, set **Neutral spool position open connections** to P-T only.

P-T spool travel between closed and open orifice — Maximum spool stroke

0.005 m (default) | positive scalar

Maximum distance of spool travel. This value provides an upper limit to calculations so that simulations do not return unphysical values.

Dependencies

To enable this parameter, set:

- 1 **Area characteristics** to Different for each flow path.
- 2 **Orifice parameterization** to Linear - Area vs. spool travel.
- 3 **Neutral spool position open connections** to P-T only.

P-T maximum orifice area — Maximum orifice opening area

1e-4 m² (default) | positive scalar

Largest open area of the P-T orifice during the operation of the valve.

Dependencies

To enable this parameter, set:

- 1 **Area characteristics** to Different for each flow path.
- 2 **Orifice parameterization** to Linear - Area vs. spool travel.
- 3 **Neutral spool position open connections** to P-T only.

P-T orifice spool travel vector – Vector of spool opening distances relative to fully closed position

[0, .00125, .0025, .00375, .005] m (default) | 1-by-*n* vector

Vector of control member travel distances for the tabular parameterization of valve area. The vector elements must correspond one-to-one with the elements in the **P-T orifice area vector** parameter. The values are listed in ascending order and the first element must be 0. Linear interpolation is employed between table data points.

Dependencies

To enable this parameter, set:

- 1 **Area characteristics** to Different for each flow path.
- 2 **Orifice parameterization** to Tabulated data - Area vs. spool travel.
- 3 **Neutral spool position open connections** to P-T only.

P-T orifice spool travel vector, ds – Vector of spool opening distances relative to fully-closed position

[0, .00125, .0025, .00375, .005] m (default) | 1-by-*n* vector

Vector of control member travel distances for the tabular parameterization of volumetric flow rate. The spool travel vector forms an independent axis with the **P-T orifice pressure drop vector, dp** parameter for the 2-D dependent **P-T orifice volumetric flow rate table, q(ds,dp)** parameter. The values are listed in ascending order and the first element must be 0. Linear interpolation is employed between table data points.

Dependencies

To enable this parameter, set:

- 1 **Area characteristics** to Different for each flow path.
- 2 **Orifice parameterization** to Tabulated data - Area vs. spool travel.
- 3 **Neutral spool position open connections** to P-T only.

P-T orifice pressure drop vector, dp – Vector of pressure differential values

[-.1, .3, .5, .7] MPa (default) | 1-by-*n* vector

Vector of pressure drop values for tabular parametrization of volumetric flow rate. The pressure drop vector forms an independent axis with the **P-T orifice spool travel vector, ds** parameter for the 2-D dependent **P-T orifice volumetric flow rate table, q(ds,dp)** parameter. The values are listed in ascending order and must be greater than 0. Linear interpolation is employed between table data points.

Dependencies

To enable this parameter, set:

- 1 **Area characteristics** to Different for each flow path.
- 2 **Orifice parameterization** to Tabulated data - Area vs. spool travel.
- 3 **Neutral spool position open connections** to P-T only.

P-T orifice volumetric flow rate table, $q(ds, dp)$ — Array of volumetric flow rates

`[-1e-08, 2.2e-08, 2.8e-08, 3.4e-08; -9e-06, .00015, .0002, .00024;
-.00036, .00063, .00081, .00096; -.00054, .00094, .0012, .0014;
-.00091, .0016, .002, .0024] m3/s (default) | M-by-N matrix`

M-by-N matrix of volumetric flow rates based on independent values of pressure drop and spool travel distance. M and N are the sizes of the correlated vectors:

- M is the number of vector elements in the **P-T orifice pressure drop vector, dp** parameter.
- N is the number of vector elements in the **P-T orifice spool travel vector, ds** parameter.

Dependencies

To enable this parameter, set:

- 1 **Area characteristics** to Different for each flow path.
- 2 **Orifice parameterization** to Tabulated data - Area vs. spool travel.
- 3 **Neutral spool position open connections** to P-T only.

Faults

Enable faults — Fault option

Off (default) | On

Enable externally or temporally triggered faults. When faulting occurs, the valve area normally set by the opening parameterization will be set to the value specified in the **Spool position area when faulted** parameter.

Spool position when faulted — Set faulted characteristics

Positive (default) | Neutral | Negative | Maintain last value

Sets the faulted valve spool position. You can choose for the valve to seize when the spool is in the positive position, negative position, or at the position when faulting is triggered.

Dependencies

To enable this parameter, set **Enable faults** to On.

Fault trigger — External or temporal trigger option

Temporal (default) | External

Whether a fault trigger occurs due to an external event or at a specified time.

When set to External, port **Tr** is enabled. A physical signal at port **Tr** that is greater than 0.5 triggers faulting.

When set to Temporal, when the **Simulation time for fault event** is reached, the valve area will be set to the value specified in the **Spool position when faulted** parameter.

Dependencies

To enable this parameter, set **Enable faults** to On.

Simulation time for fault event – Time at which faulting is triggered

5 s (default) | positive scalar

When the **Simulation time for fault event** is reached, the valve area is set to the value specified in the **Spool position when faulted** parameter.

Dependencies

To enable this parameter, set **Enable faults** to On and **Fault trigger** to Temporal.

See Also

3-Way Directional Valve (IL) | Cartridge Valve Actuator (IL) | Shuttle Valve (IL) | 4-Way Directional Valve (TL)

Topics

“Modeling Valves in Simscape Fluids”

Introduced in R2020a

4-Way 2-Position Directional Valve (IL)

4-way, 2-position directional valve in an isothermal liquid network

Library: Simscape / Fluids / Isothermal Liquid / Valves & Orifices / Directional Control Valves

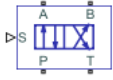

Description

The 4-Way 2-Position Directional Valve (IL) block models a valve with four openings in an isothermal liquid network, typically between an actuator, pump, and tank. The valve operation is controlled by a single spool displaced according to the signal at port **S**. You can set the baseline configuration of your valve by specifying the orifices that are open when the spool moves in the positive direction and negative directions in the **Positive spool position open connections** and **Negative spool position open connections** parameters, respectively.

You can set the model for valve opening in the **Orifice parameterization** parameter as a linear relationship or function of user-provided data, which can be applied to one or all flow paths in the valve.

In some configurations, this valve resembles a 3-way valve. To set additional flow paths when the spool is in the neutral position, see the 4-Way 3-Position Directional Valve (IL) block.

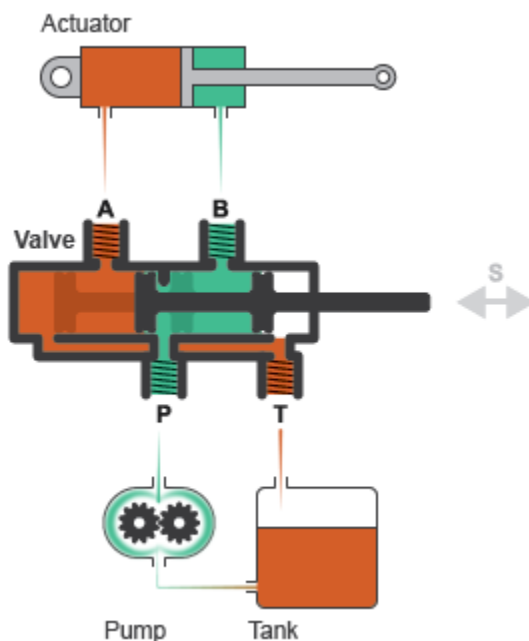

Example Valve Setup

In this configuration, **Negative spool position open connections** is set to P-A and B-T. When the signal at port **S** moves the spool to a negative position, the paths between ports **P** and **A** and between

ports **B** and **T** are open to flow. The paths between ports **P** and **B** and ports **A** and **T** are closed to flow:

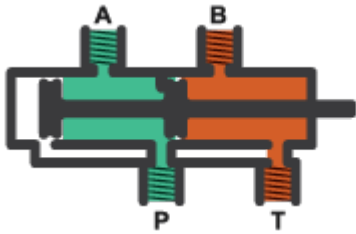

In this configuration, **Positive spool position open connections** is set to P-B and A-T. When the signal at port **S** moves the spool to a positive position, the paths between ports **P** and **B** and between ports **A** and **T** are open to flow and the paths between ports **P** and **A** and between ports **B** and **T** are closed:

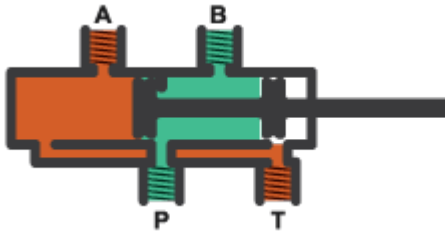

Schematically, this configuration is:

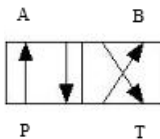

The left-hand side corresponds to the positive position and the right-hand side corresponds to the negative position. The valve transitions through positions in the neutral mid-section.

Spool Displacement and Valve Configuration

The *spool stroke* is the amount of spool travel an orifice takes to fully open from a closed position and is defined for each orifice selected on the **Valve Configuration** tab. The table below shows how the stroke is calculated in accordance with the valve orifice parameterization and flow path characteristics.

Spool Stroke Based on Parameterization and Flow Path

Orifice Parameterization	Identical for All Flow Paths	Different for Each Flow Path
Linear - Area vs. spool travel	Defined by the Spool travel between closed and open orifice parameter	Defined by the Spool travel between closed and open orifice parameter, for each orifice
Tabulated data - Area vs. spool travel	The difference between the first and last element of the Spool travel vector parameter	The difference between the first and last element of the spool travel vector parameter for each orifice
Tabulated data - Volumetric flow rate vs. spool travel and pressure drop	The difference between the first and last element of the Spool travel vector, ds parameter	The difference between the first and last element of the spool travel vector, ds parameter for each orifice

To see the orientation of all valve orifices, see the “Visualize Orifice Openings” on page 1-209 section.

The direction of spool movement signaled at port **S** depends on the spool stroke and the orifice orientation:

Orifice Definition and Spool Travel Direction

Spool Position when Orifice is Open	Spool Travel, ΔS
Always closed (orifice is not selected in any spool position configuration)	N/A
Always open (orifice is selected in positive, neutral, and negative spool position configurations)	N/A
Negative	$S_{\text{orifice_max}} + \text{spool stroke} - \mathbf{S}$
Positive	$S_{\text{orifice_max}} + \text{spool stroke} + \mathbf{S}$

Where $S_{\text{orifice_max}}$ is the spool position at the maximum orifice area defined for each orifice.

The possible configurations of the 4-Way 2-Position Directional Valve (IL) block are shown below.

4-Way 2-Position Directional Valve Configuration

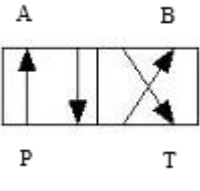
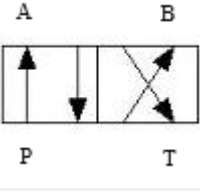
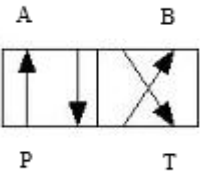
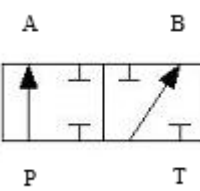
Configuration	Parameter Values
 <p>All four paths are closed during transition.</p>	<ul style="list-style-type: none"> • Positive spool position open connections: P-A and B-T • Negative spool position open connections: P-B and A-T • Spool position at maximum P-A orifice area > P-A spool stroke • Spool position at maximum P-B orifice area < -P-B spool stroke • Spool position at maximum A-T orifice area < -A-T spool stroke • Spool position at maximum B-T orifice area > B-T spool stroke
 <p>All four paths are open during transition.</p>	<ul style="list-style-type: none"> • Positive spool position open connections: P-A and B-T • Negative spool position open connections: P-B and A-T • Spool position at maximum P-A orifice area < P-A spool stroke • Spool position at maximum P-B orifice area > -P-B spool stroke • Spool position at maximum A-T orifice area > -A-T spool stroke • Spool position at maximum B-T orifice area < B-T spool stroke
 <p>A-T and B-T are closed during transition.</p>	<ul style="list-style-type: none"> • Positive spool position open connections: P-A and B-T • Negative spool position open connections: P-B and A-T • Spool position at maximum P-A orifice area < P-A spool stroke • Spool position at maximum P-B orifice area > -P-B spool stroke • Spool position at maximum A-T orifice area < -A-T spool stroke • Spool position at maximum B-T orifice area > B-T spool stroke
 <p>P-A and P-B are closed during transition.</p>	<ul style="list-style-type: none"> • Positive spool position open connections: P-A only • Negative spool position open connections: P-B only • Spool position at maximum P-A orifice area > P-A spool stroke • Spool position at maximum P-B orifice area < -P-B spool stroke

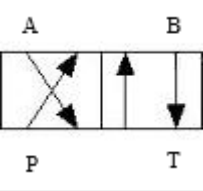
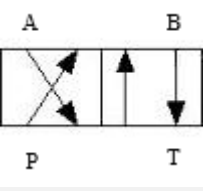
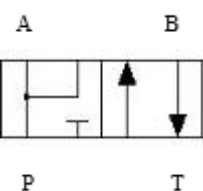
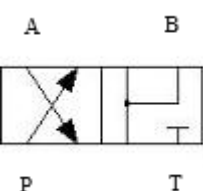
Configuration	Parameter Values
 <p>P-B and B-T are closed during transition.</p>	<ul style="list-style-type: none"> • Positive spool position open connections: P-B and A-T • Negative spool position open connections: P-A and B-T • Spool position at maximum P-A orifice area < P-A spool stroke • Spool position at maximum P-B orifice area > P-B spool stroke • Spool position at maximum A-T orifice area > A-T spool stroke • Spool position at maximum B-T orifice area < -B-T spool stroke
 <p>P-A and A-T are closed during transition.</p>	<ul style="list-style-type: none"> • Positive spool position open connections: P-B and A-T • Negative spool position open connections: P-A and B-T • Spool position at maximum P-A orifice area < -P-A spool stroke • Spool position at maximum P-B orifice area < P-B spool stroke • Spool position at maximum A-T orifice area > A-T spool stroke • Spool position at maximum B-T orifice area > -B-T spool stroke
 <p>P-A, P-B, and B-T are open during transition.</p>	<ul style="list-style-type: none"> • Positive spool position open connections: P-A and P-B • Negative spool position open connections: P-A and B-T • Spool position at maximum P-A orifice area < P-A spool stroke • Spool position at maximum P-B orifice area < P-B spool stroke • Spool position at maximum A-T orifice area = any value • Spool position at maximum B-T orifice area > -B-T spool stroke
 <p>P-A, A-T, and B-T are open during transition.</p>	<ul style="list-style-type: none"> • Positive spool position open connections: P-B and A-T • Negative spool position open connections: P-A and P-B • Spool position at maximum P-A orifice area > -P-A spool stroke • Spool position at maximum A-T orifice area < A-T spool stroke • Spool position at maximum B-T orifice area = any value

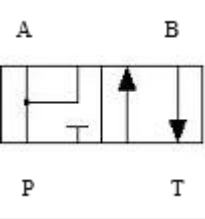
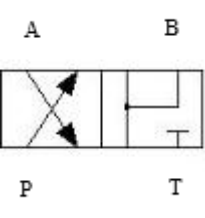
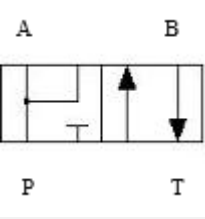
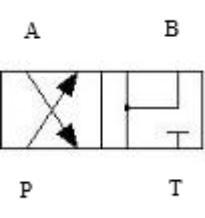
Configuration	Parameter Values
 <p>P-A and P-B are closed during transition. A-T is always closed.</p>	<ul style="list-style-type: none"> • Positive spool position open connections: P-A and P-B • Negative spool position open connections: P-A and B-T • Spool position at maximum P-B orifice area > P-B spool stroke • Spool position at maximum B-T orifice area < -B-T spool stroke
 <p>All paths are closed during transition.</p>	<ul style="list-style-type: none"> • Positive spool position open connections: P-B and A-T • Negative spool position open connections: P-A and P-B • Spool position at maximum P-A orifice area < -P-A spool stroke • Spool position at maximum P-B orifice area > P-B spool stroke • Spool position at maximum A-T orifice area > A-T spool stroke
 <p>A-T is open during transition. P-A is closed during transition.</p>	<ul style="list-style-type: none"> • Positive spool position open connections: P-A and P-B • Negative spool position open connections: P-A and B-T • Spool position at maximum P-A orifice area > P-A spool stroke • Spool position at maximum P-B orifice area > P-B spool stroke • Spool position at maximum A-T orifice area = any value • Spool position at maximum B-T orifice area > -B-T spool stroke
 <p>B-T is open during transition. P-B is closed during transition.</p>	<ul style="list-style-type: none"> • Positive spool position open connections: P-B and A-T • Negative spool position open connections: P-A and P-B • Spool position at maximum P-A orifice area < -P-A spool stroke • Spool position at maximum P-B orifice area > P-B spool stroke • Spool position at maximum A-T orifice area < A-T spool stroke • Spool position at maximum B-T orifice area = any value

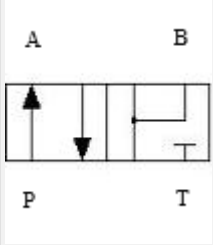
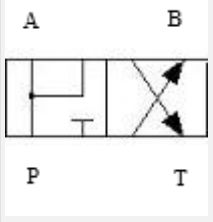
Configuration	Parameter Values
 <p>P-A is closed during transition.</p>	<ul style="list-style-type: none"> • Positive spool position open connections: P-A and B-T • Negative spool position open connections: P-A and P-B • Spool position at maximum P-A orifice area > P-A spool stroke • Spool position at maximum P-B orifice area < -P-B spool stroke • Spool position at maximum B-T orifice area > B-T spool stroke
 <p>P-B is closed during transition.</p>	<ul style="list-style-type: none"> • Positive spool position open connections: P-A and P-B • Negative spool position open connections: P-B and A-T • Spool position at maximum P-A orifice area > P-A spool stroke • Spool position at maximum P-B orifice area > P-B spool stroke • Spool position at maximum A-T orifice area > -A-T spool stroke

Valve Orifice Parameterizations

The **Orifice parameterization** parameter sets the model for the open area or volumetric flow rate through one or all of the valve orifices. If you set **Area characteristics** to `Identical` for all flow paths, the block applies the same data for all flow paths; otherwise, individual parameterizations are applied for the `Different` for all flow paths setting. You can model valve opening in three ways:

- Linear - area vs. spool travel

The opening area is a linear function of the spool position received as a signal at port **S**:

$$A_{orifice} = \frac{(A_{max} - A_{leak})}{\Delta S_{max}} \Delta S + A_{leak},$$

where:

- ΔS is the spool travel defined in Orifice Definition and Spool Travel Direction.
- ΔS_{max} is the **Spool travel between closed and open orifice**.
- A_{max} is the **Maximum orifice area**.
- A_{leak} is the **Leakage area**.

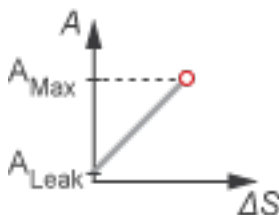

- Tabulated data - Area vs. spool travel

Provide spool travel vectors for your system or for individual flow paths between ports **P**, **A**, **B**, and **T**. This data will be used to calculate the relationship between the orifice area and spool displacement. Interpolation is used to determine the opening area between given data points. A_{leak} and A_{max} are the first and last parameters of the opening area vector, respectively.

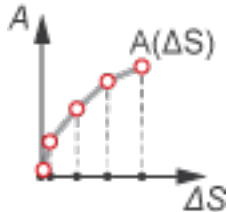

- Tabulated data - Volumetric flow rate vs. spool travel and pressure drop

Provide spool travel and pressure drop vectors and a dependent, 2-D volumetric flow rate array. Interpolation is used to determine flow rate between given data points. The mass flow rate is the product of the volumetric flow rate and the local density.

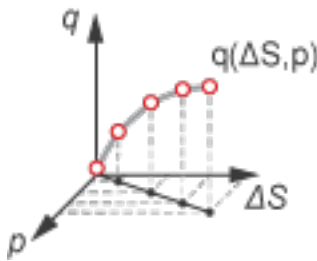

Numerically-Smoothed Valve Area in the Linear Parameterization

When the valve is in a near-open or near-closed position in the linear parameterization, you can maintain numerical robustness in your simulation by adjusting the block **Smoothing factor**. A smoothing function is applied to all calculated areas, but primarily influences the simulation at the extremes of the valve area.

The normalized valve area is calculated as:

$$\hat{A} = \frac{(A_{orifice} - A_{leak})}{(A_{max} - A_{leak})}$$

The **Smoothing factor**, s , is applied to the normalized area:

$$\hat{A}_{smoothed} = \frac{1}{2} + \frac{1}{2} \sqrt{\hat{A}^2 + \left(\frac{s}{4}\right)^2} - \frac{1}{2} \sqrt{(\hat{A} - 1)^2 + \left(\frac{s}{4}\right)^2}$$

The smoothed valve area is:

$$A_{smoothed} = \hat{A}_{smoothed}(A_{max} - A_{leak}) + A_{leak}$$

Visualize Orifice Openings

To visualize spool offsets and maximum displacement, right-click on the block and select **Fluids > Plot Valve Characteristics**. The plot shows the orifices selected in the **Valve Configuration** tab settings. The axes are set by the orifice parameterization selection and are either:

- Orifice Area vs. Spool Position
- Volumetric Flow Rate vs. Spool Position, queried at a specific pressure differential

When the positive and negative settings in the **Valve Configuration** tab feature the same orifice, the orifice opening is displayed as a constant.

Each time you modify the block settings, click **Apply** at the bottom of the dialog box, then click **Reload Data** on the figure window.

The image below shows the valve default configuration. On the **Valve Configuration** tab:

- **Positive spool position open connections** is set to P-A and B-T.
- **Negative spool position open connections** is set to P-B and A-T.

All other spool positions are at the default values.

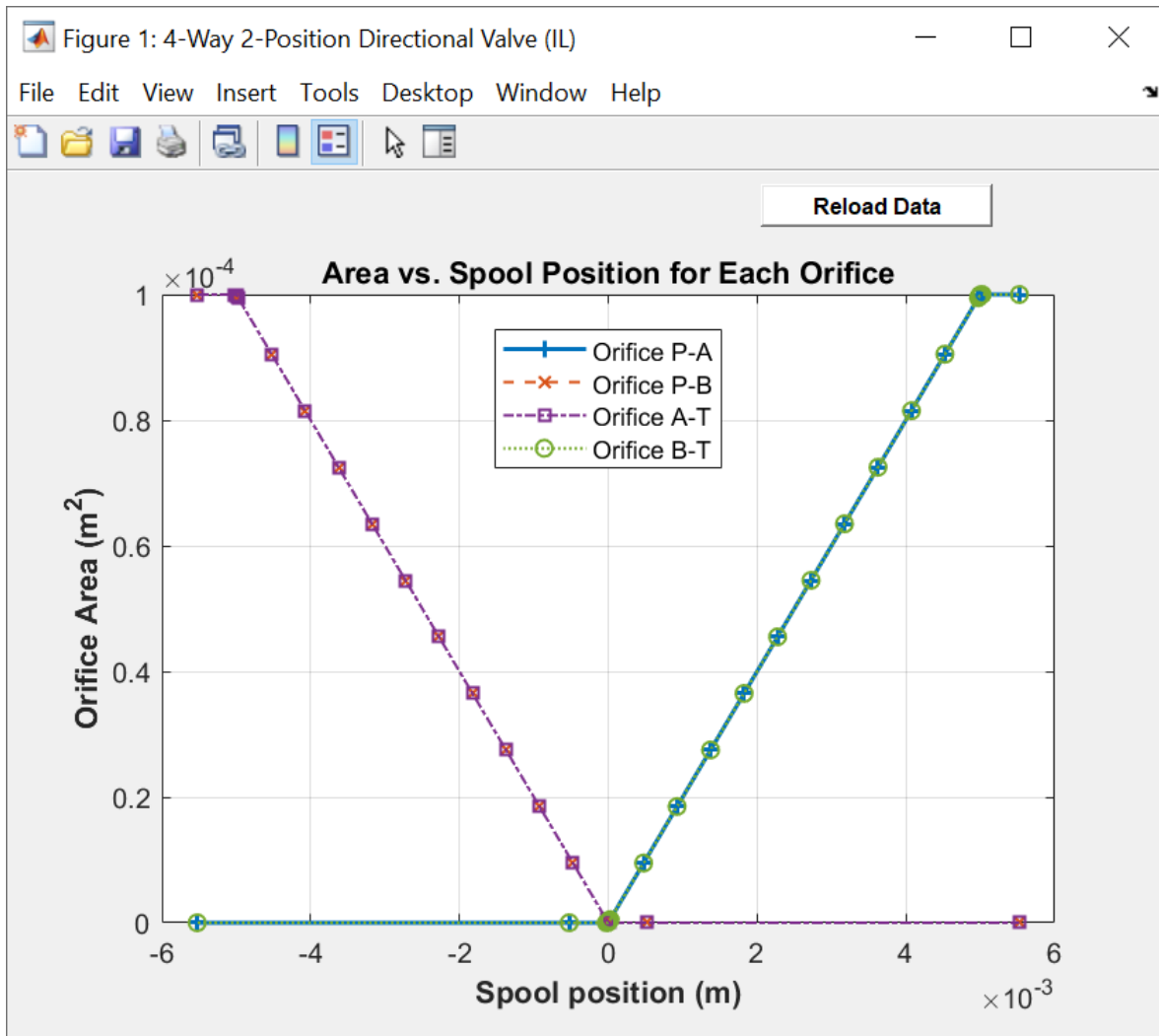

Example Spool Position Visualization

Faulty Behavior

When faults are enabled, the valve open area becomes stuck at a specified spool position in response to one of these triggers:

- Simulation time — Faulting occurs at a specified time.
- Simulation behavior — Faulting occurs in response to an external trigger. This exposes port **Tr**.

Four fault options are available in the **Spool position when faulted** parameter:

- **Positive** — The spool position freezes in the positive position, opening the **Positive spool position open connections** flow paths to their maximum value. The flow paths that are only open in the **Negative spool position open connections** and **Neutral spool position open connections** are closed.
- **Negative** — The spool position freezes in the negative position, opening the **Negative spool position open connections** flow paths to their maximum value. The flow paths that are only

open in the **Positive spool position open connections** and **Neutral spool position open connections** are closed.

- **Maintain last value** — The valve freezes at the spool position when the trigger occurs.

Due to numerical smoothing at the extremes of the valve area, in the linear parameterization, the minimum area applied is larger than the **Leakage area**, and the maximum is smaller than the **Maximum orifice area**, in proportion to the **Smoothing factor** value.

Once triggered, the valve remains at the faulted area for the rest of the simulation.

Predefined Parameterization

Pre-parameterization of the 4-Way 2-Position Directional Valve (IL) block with manufacturer data is available. This data allows you to model a specific supplier component.

To load a predefined parameterization,

- 1 Click the "Select a predefined parameterization" hyperlink in the 4-Way 2-Position Directional Valve (IL) block dialog description.
- 2 Select a part from the drop-down menu and click **Update block with selected part**.
- 3 If you change any parameter settings after loading a parameterization, you can check your changes by clicking **Compare block settings with selected part**. Any difference in settings between the block and pre-defined parameterization will display in the MATLAB command window.

Note that it is not possible to set different values for the same orifice for both positive and negative displacement of the control member. Additionally, the opening area is mirrored around the neutral position.

Note Predefined parameterizations of Simscape components use available data sources for supplying parameter values. Engineering judgement and simplifying assumptions are used to fill in for missing data. As a result, deviations between simulated and actual physical behavior should be expected. To ensure requisite accuracy, you should validate simulated behavior against experimental data and refine component models as necessary.

Ports

Conserving

A — Liquid port

isothermal liquid

Liquid entry or exit port to the valve.

B — Liquid port

isothermal liquid

Liquid entry or exit port to the valve.

P — Liquid port

isothermal liquid

Liquid entry or exit port to the valve.

T – Liquid port

isothermal liquid

Liquid entry or exit port to the valve.

Input**S – Spool displacement, m**

physical signal

Spool displacement, in m, specified as a physical signal.

Tr – External fault trigger

physical signal

Physical signal port for an external fault trigger. Triggering occurs when the value is greater than 0.5. There is no unit associated with the trigger value.

DependenciesThis port is visible when **Enable faults** is set to On and **Fault trigger** is set to External.**Parameters****Valve Configuration****Positive spool position open connections – Flow paths open when the spool is in a positive position**

P-A and B-T (default) | P-A and P-B | P-B and A-T | P-A only | P-B only

Flow paths open when the spool is in a positive position. This parameter sets the valve configuration and defines the direction of spool movement according to the signal received at port **S**.**Negative spool position open connections – Flow paths open when the spool moves in the negative direction**

P-B and A-T (default) | P-A and B-T | P-A and P-B | P-A only | P-B only

Flow paths open when the spool moves in the negative direction. This parameter sets the valve configuration and defines the direction of spool movement according to the signal received at port **S**.**Model Parameterization****Area characteristics – Flow equations for orifices**

Identical for all flow paths (default) | Different for each flow path

Applies uniform or individual flow equations for the valve orifice area. **Identical for all flow paths** uses the same orifice and spool geometries, flow rates, pressure, and area vectors for all valve orifices. When using **Different for each flow path**, these parameters are specified individually for each orifice. In both cases, orifices **A**, **B**, **P**, and **T** have the same cross-sectional areas, discharge coefficients, and Reynolds numbers in the **Linear - Area vs. spool travel** and **Tabulated data - Area vs. spool travel** parameterizations. The same **Orifice parameterization** is applied to all flow paths.

Orifice parameterization — Method of calculating opening area

Linear area vs. spool travel (default) | Tabulated data - Area vs. spool travel |
Tabulated data - Volumetric flow rate vs. spool travel and pressure drop

Method of calculating the valve opening area. In the tabulated data parameterizations, you can provide your own valve area and spool travel data for nonlinear valve opening profiles, or you can provide data in terms of volumetric flow rate, spool travel, and pressure drop over the flow path.

Spool travel between closed and open orifice — Maximum spool stroke

0.005 m (default) | positive scalar

Maximum distance of spool travel.

Dependencies

To enable this parameter, set **Area characteristics** to Identical for all flow paths and **Orifice parameterization** to Linear - Area vs. spool travel.

Maximum orifice area — Maximum orifice opening area

1e-4 m² (default) | positive scalar

Largest open area of each orifice during the operation of the valve.

Dependencies

To enable this parameter, set **Area characteristics** to Identical for all flow paths and **Orifice parameterization** to Linear - Area vs. spool travel.

Leakage area — Open area when an orifice is fully closed

1e-9 m² (default) | positive scalar

Open area when an orifice is fully closed. Any area smaller than this value is maintained at the specified leakage area. This parameter contributes to numerical stability by maintaining continuity in the flow.

Dependencies

To enable this parameter, set **Orifice parameterization** to Linear - Area vs. spool travel.

Spool travel vector — Vector of spool opening distances relative to fully closed position

[0, .00125, .0025, .00375, .005] m (default) | 1-by-*n* vector

Vector of spool travel distances for the tabular parameterization of valve area. The vector elements must correspond one-to-one with the elements in the **Orifice area vector** parameter. The values are listed in ascending order and the first element must be 0. Linear interpolation is employed between table data points.

Dependencies

To enable this parameter, set **Area characteristics** to Identical for all flow paths and **Orifice parameterization** to Tabulated data - Area vs. spool travel.

Orifice area vector — Vector of valve opening areas

[1e-09, 1e-05, 4e-05, 6e-05, .0001] m² (default) | 1-by-*n* vector

Vector of opening areas for the tabular parameterization of valve opening area. The vector elements must correspond one-to-one with the elements in the **Spool travel vector** parameter. The elements are listed in ascending order and must be greater than 0.

Dependencies

To enable this parameter, set **Area characteristics** to Identical for all flow paths and **Orifice parameterization** to Tabulated data - Area vs. spool travel.

Spool travel vector, **ds** – Vector of spool opening distances relative to fully closed position

[0, .00125, .0025, .00375, .005] m (default) | 1-by-*n* vector

Vector of spool travel distances for the tabular parametrization of volumetric flow rate. The spool travel vector forms an independent axis with the **Pressure drop vector, dp** parameter for the 2-D dependent **Volumetric flow rate table, q(ds,dp)** parameter. The values are listed in ascending order and the first element must be 0. Linear interpolation is employed between table data points.

Dependencies

To enable this parameter, set **Area characteristics** to Identical for all flow paths and **Orifice parameterization** to Tabulated data - Volumetric flow rate vs. spool travel and pressure drop.

Pressure drop vector, **dp** – Vector of valve pressure drop values

[-.1, .3, .5, .7] MPa (default) | 1-by-*n* vector

Vector of pressure drop values for the tabular parametrization of volumetric flow rate. The pressure drop vector forms an independent axis with the **Spool travel vector, ds** parameter for the 2-D dependent **Volumetric flow rate table, q(ds,dp)** parameter. The values are listed in ascending order and must be greater than 0. Linear interpolation is employed between table data points.

Dependencies

To enable this parameter, set **Area characteristics** to Identical for all flow paths and **Orifice parameterization** to Tabulated data - Volumetric flow rate vs. spool travel and pressure drop.

Volumetric flow rate table, **q(ds,dp)** – Array of volumetric flow rates

[-1e-08, 2.2e-08, 2.8e-08, 3.4e-08; -9e-06, .00015, .0002, .00024;
-.00036, .00063, .00081, .00096; .00054, .00094, .0012, .0014;
-.00091, .0016, .002, .0024] m³/s (default) | *M*-by-*N* matrix

M-by-*N* matrix of volumetric flow rates based on independent values of pressure drop and spool travel distance. *M* and *N* are the sizes of the correlated vectors:

- *M* is the number of vector elements in the **Pressure drop vector, dp** parameter.
- *N* is the number of vector elements in the **Spool travel vector, ds** parameter.

Dependencies

To enable this parameter, set **Area characteristics** to Identical for all flow paths and **Orifice parameterization** to Tabulated data - Volumetric flow rate vs. spool travel and pressure drop.

Constant orifice area — Orifice area for identical flow paths1e-4 m² (default) | positive scalar

Orifice area when the positive and negative spool positions feature the same orifice.

Dependencies

To enable this parameter, set **Area characteristics** to Identical for all flow paths and **Orifice parameterization** to either:

- Linear - area vs. spool travel.
- Tabulated data - Area vs. spool travel

The same orifice must be selected in both of the **Valve Configuration** parameters:

- **Positive spool position open connections**
- **Negative spool position open connections**

Constant orifice pressure drop vector — Vector of pressure differential values for identical flow paths[-.1, .3, .5, .7] MPa (default) | 1-by-*n* vector

Vector of pressure differential values over the valve when the positive and negative spool positions feature the same orifice. The vector elements correspond one-to-one with the elements in the **Constant orifice volumetric flow rate vector** parameter. The values are listed in ascending order. Linear interpolation is employed between table data points.

Dependencies

To enable this parameter, set **Area characteristics** to Identical for all flow paths and **Orifice parameterization** to Tabulated data - Volumetric flow rate vs. spool travel and pressure drop.

The same orifice must be selected in both of the **Valve Configuration** parameters:

- **Positive spool position open connections**
- **Negative spool position open connections**

Constant orifice volumetric flow rate vector — Vector of volumetric flow rate values for identical flow paths[-.0009, .0016, .002, .0024] m³/s (default) | 1-by-*n* vector

Vector of volumetric flow rate values for a constant orifice when the positive and negative spool positions feature the same orifice. The vector elements correspond one-to-one with the elements in the **Constant orifice pressure drop vector** parameter. The values are listed in ascending order. Linear interpolation is employed between table data points.

Dependencies

To enable this parameter, set **Area characteristics** to Identical for all flow paths and **Orifice parameterization** to Tabulated data - Volumetric flow rate vs. spool travel and pressure drop.

The same orifice must be selected in both of the **Valve Configuration** parameters:

- **Positive spool position open connections**
- **Negative spool position open connections**

Cross-sectional area at ports P, T, A and B – Area at conserving ports

inf m² (default) | positive scalar

Maximum cross-sectional areas at the entry and exit ports **P**, **T**, **A**, and **B**, which are used in the pressure-flow rate equation that determines the mass flow rate through the valve.

Dependencies

To enable this parameter, set **Area characteristics** to `Identical` for all flow paths and **Orifice parameterization** to either:

- Linear - area vs. spool travel
- Tabulated data - Area vs. spool travel

Discharge coefficient – Discharge coefficient

0.64 (default) | positive scalar

Correction factor that accounts for discharge losses in theoretical flows.

Dependencies

To enable this parameter, set **Orifice parameterization** to either:

- Linear - Area vs. spool travel
- Tabulated data - Area vs. spool travel

Critical Reynolds number – Upper Reynolds number limit for laminar flow

150 (default) | positive scalar

Upper Reynolds number limit for laminar flow through the orifice.

Dependencies

To enable this parameter, set **Orifice parameterization** to:

- Linear - area vs. spool travel
- Tabulated data - Area vs. spool travel

Smoothing factor – Numerical smoothing factor

0.01 (default) | positive scalar in the range of [0,1]

Continuous smoothing factor that introduces a layer of gradual change based to the flow response when the valve is in near-open and near-closed positions. To increase the stability of your simulation in these regimes, set this parameter to a nonzero value less than one.

Dependencies

To enable this parameter, set **Orifice parametrization** to `Linear - area vs. spool travel`.

Pressure recovery – Whether to account for pressure increase in area expansions

Off (default) | On

Whether to account for pressure increase when fluid flows from a region of smaller cross-sectional area to a region of larger cross-sectional area.

Dependencies

To enable this parameter, set **Orifice parameterization** to:

- Linear - area vs. spool travel
- Tabulated data - Area vs. spool travel

P-A Orifice

Spool position at maximum P-A orifice area — Spool offset for fully open P-A orifice
 $5e-3$ m (default) | positive scalar

Spool offset from the neutral position for a fully open P-A orifice. To visualize the defined offsets, see “Visualize Orifice Openings” on page 1-209.

Dependencies

To enable this parameter, set one of the following parameters:

Positive spool position open connections to:

- P-A and B-T
- P-A and P-B
- P-A only

Negative spool position open connections to:

- P-A and B-T
- P-A and P-B
- P-A only

Note: This parameter is enabled only when the P-A orifice settings do not appear in both spool position parameters: **Positive spool position open connections** and **Negative spool position open connections**.

P-A spool travel between closed and open orifice — Maximum spool stroke
 0.005 m (default) | positive scalar

Maximum distance of spool travel. This value provides an upper limit to calculations so that simulations do not return unphysical values.

Dependencies

To enable this parameter, set:

- 1 **Area characteristics** to Different for each flow path.
- 2 **Orifice parameterization** to Linear - Area vs. spool travel.
- 3 One of the following parameters:

Positive spool position open connections to:

- P-A and B-T
- P-A and P-B
- P-A only

Negative spool position open connections to:

- P-A and B-T
- P-A and P-B
- P-A only

P-A maximum orifice area — Maximum orifice opening area

1e-4 m² (default) | positive scalar

Largest open area of the P-A orifice during the operation of the valve.

Dependencies

To enable this parameter, set:

- 1 Area characteristics** to Different for each flow path.
- 2 Orifice parameterization** to Linear - Area vs. spool travel.
- 3** One of the following parameters:

Positive spool position open connections to:

- P-A and B-T
- P-A and P-B
- P-A only

Negative spool position open connections to:

- P-A and B-T
- P-A and P-B
- P-A only

P-A orifice spool travel vector — Vector of spool opening distances relative to fully closed position

[0, .00125, .0025, .00375, .005] m (default) | 1-by-*n* vector

Vector of spool travel distances for the tabular parameterization of valve area. The vector elements must correspond one-to-one with the elements in the **P-A orifice area vector** parameter. The values are listed in ascending order and the first element must be 0. Linear interpolation is employed between table data points.

Dependencies

To enable this parameter, set:

- 1 Area characteristics** to Different for each flow path.
- 2 Orifice parameterization** to Tabulated data - Area vs. spool travel.
- 3** One of the following parameters:

Positive spool position open connections to:

- P-A and B-T
- P-A and P-B
- P-A only

Negative spool position open connections to:

- P-A and B-T
- P-A and P-B
- P-A only

P-A orifice area vector – Vector of valve opening areas

[1e-10, 1e-05, 4e-05, 6e-05, .0001] m² (default) | 1-by-*n* vector

Vector of opening areas for the tabular parameterization of valve opening area. The vector elements must correspond one-to-one with the elements in the **P-A spool travel vector** parameter. The elements are listed in ascending order and must be greater than 0.

Dependencies

To enable this parameter, set:

- 1 Area characteristics** to Different for each flow path.
- 2 Orifice parameterization** to Tabulated data - Area vs. spool travel.
- 3** One of the following parameters:

Positive spool position open connections to:

- P-A and B-T
- P-A and P-B
- P-A only

Negative spool position open connections to:

- P-A and B-T
- P-A and P-B
- P-A only

P-A orifice spool travel vector, ds – Vector of spool opening distances relative to fully closed position

[0, .00125, .0025, .00375, .005] m (default) | 1-by-*n* vector

Vector of spool travel distances for the tabular parameterization of volumetric flow rates. The spool travel vector forms an independent axis with the **P-A orifice pressure drop vector, dp** parameter for the 2-D dependent **P-A orifice volumetric flow rate table, q(ds,dp)** parameter. The values are listed in ascending order and the first element must be 0. Linear interpolation is employed between table data points.

Dependencies

To enable this parameter, set:

- 1 Area characteristics** to Different for each flow path.

2 Orifice parameterization to Tabulated data - Volumetric flow rate vs. spool travel and pressure drop.

3 One of the following parameters:

Positive spool position open connections to:

- P-A and B-T
- P-A and P-B
- P-A only

Negative spool position open connections to:

- P-A and B-T
- P-A and P-B
- P-A only

P-A orifice pressure drop vector, dp — Vector of pressure drop values

`[-.1, .3, .5, .7]` MPa (default) | 1-by- n vector

Vector of pressure drop values for the tabular parametrization of volumetric flow rate. The pressure drop vector forms an independent axis with the **P-A orifice spool travel vector, ds** parameter for the 2-D dependent **P-A orifice volumetric flow rate table, $q(ds,dp)$** parameter. The values are listed in ascending order and must be greater than 0. Linear interpolation is employed between table data points.

Dependencies

To enable this parameter, set:

1 Area characteristics to Different for each flow path.

2 Orifice parameterization to Tabulated data - Volumetric flow rate vs. spool travel and pressure drop.

3 One of the following parameters:

Positive spool position open connections to:

- P-A and B-T
- P-A and P-B
- P-A only

Negative spool position open connections to:

- P-A and B-T
- P-A and P-B
- P-A only

P-A orifice volumetric flow rate table, $q(ds,dp)$ — Array of volumetric flow rate values

`[-1e-08, 2.2e-08, 2.8e-08, 3.4e-08; -9e-06, .00015, .0002, .00024; -.00036, .00063, .00081, .00096; -.00054, .00094, .0012, .0014; -.00091, .0016, .002, .0024]` m³/s (default) | M -by- N matrix

M -by- N matrix of volumetric flow rates based on independent values of pressure drop and spool travel distance. M and N are the sizes of the correlated vectors:

- M is the number of vector elements in the **P-A orifice pressure drop vector, dp** parameter.
- N is the number of vector elements in the **P-A orifice spool travel vector, ds** parameter.

Dependencies

To enable this parameter, set:

- 1 **Area characteristics** to Different for each flow path.
- 2 **Orifice parameterization** to Tabulated data - Volumetric flow rate vs. spool travel and pressure drop.
- 3 One of the following parameters:

Positive spool position open connections to:

- P-A and B-T
- P-A and P-B
- P-A only

Negative spool position open connections to:

- P-A and B-T
- P-A and P-B
- P-A only

P-A constant orifice area — Cross-sectional area for a constant orifice

1e-4 m² (default) | positive scalar

Orifice area when the positive and negative spool positions feature the same orifice.

Dependencies

To enable this parameter, set:

- 1 **Area characteristics** to Different for each flow path.
- 2 **Orifice parameterization** to either:
 - Linear - area vs. spool travel
 - Tabulated data - Area vs. spool travel
- 3 One of the following settings in each parameter:

Positive spool position open connections to:

- P-A and B-T
- P-A and P-B
- P-A only

Negative spool position open connections to:

- P-A and B-T

- P-A and P-B
- P-A only

P-A Constant orifice pressure drop vector — Vector of pressure differential values for a constant orifice

[-.1, .3, .5, .7] MPa (default) | 1-by-*n* vector

Vector of pressure differential values over the valve when the positive and negative spool positions feature the same orifice. The vector elements correspond one-to-one with the elements in the **P-A Constant orifice volumetric flow rate vector** parameter. The values are listed in ascending order. Linear interpolation is employed between table data points.

Dependencies

To enable this parameter, set:

- 1 **Area characteristics** to Different for each flow path.
- 2 **Orifice parameterization** to Tabulated data - Volumetric flow rate vs. spool travel and pressure drop.
- 3 One of the following settings in each parameter:

Positive spool position open connections to:

- P-A and B-T
- P-A and P-B
- P-A only

Negative spool position open connections to:

- P-A and B-T
- P-A and P-B
- P-A only

P-A Constant orifice volumetric flow rate vector — Vector of volumetric flow rates for a constant orifice

[-.0009, .0016, .002, .0024] m³/s (default) | 1-by-*n* vector

Vector of pressure differential values over the valve when the positive and negative spool positions feature the same orifice. The vector elements correspond one-to-one with the elements in the **P-A Constant orifice pressure drop vector** parameter. The values are listed in ascending order. Linear interpolation is employed between table data points.

Dependencies

To enable this parameter, set:

- 1 **Area characteristics** to Different for each flow path.
- 2 **Orifice parameterization** to Tabulated data - Volumetric flow rate vs. spool travel and pressure drop.
- 3 One of the following settings in each parameter:

Positive spool position open connections to:

- P-A and B-T
- P-A and P-B
- P-A only

Negative spool position open connections to:

- P-A and B-T
- P-A and P-B
- P-A only

P-B Orifice

Spool position at maximum P-B orifice area — Spool offset from the neutral position for a fully open P-B orifice

-5e-3 (default) | positive scalar

Spool offset from the neutral position for a fully open P-B orifice. To visualize the defined offsets, see “Visualize Orifice Openings” on page 1-209.

Dependencies

To enable this parameter, set one of the following parameters:

Positive spool position open connections to:

- P-B and A-T
- P-A and P-B
- P-B only

Negative spool position open connections to:

- P-B and A-T
- P-A and P-B
- P-B only

Note: This parameter is enabled only when the P-B orifice settings do not appear in both spool position parameters: **Positive spool position open connections** and **Negative spool position open connections**.

P-B spool travel between closed and open orifice — Maximum spool stroke

0.005 m (default) | positive scalar

Maximum distance of spool travel. This value provides an upper limit to calculations so that simulations do not return unphysical values.

Dependencies

To enable this parameter, set:

- 1 **Area characteristics** to Different for each flow path.
- 2 **Orifice parameterization** to Linear - Area vs. spool travel.

- 3** One of the following parameters:

Positive spool position open connections to:

- P-B and A-T
- P-A and P-B
- P-B only

or set **Negative spool position open connections to:**

- P-B and A-T
- P-A and P-B
- P-B only

P-B maximum orifice area — Maximum orifice opening area

1e-4 m² (default) | positive scalar

Largest open area of the P-B orifice during the operation of the valve.

Dependencies

To enable this parameter, set:

- 1 Area characteristics** to Different for each flow path.
- 2 Orifice parameterization** to Linear - Area vs. spool travel.
- 3** One of the following parameters:

Positive spool position open connections to:

- P-B and A-T
- P-A and P-B
- P-B only

Negative spool position open connections to:

- P-B and A-T
- P-A and P-B
- P-B only

P-B orifice spool travel vector — Vector of spool opening distances relative to fully closed position

[0, .00125, .0025, .00375, .005] m (default) | 1-by-*n* vector

Vector of spool travel distances for the tabular parameterization of valve area. The vector elements must correspond one-to-one with the elements in the **P-B orifice area vector** parameter. The values are listed in ascending order and the first element must be 0. Linear interpolation is employed between table data points.

Dependencies

To enable this parameter, set:

- 1 Area characteristics** to Different for each flow path.

- 2 **Orifice parameterization** to Tabulated data - Area vs. spool travel.
- 3 One of the following parameters:

Positive spool position open connections to:

- P-B and A-T
- P-A and P-B
- P-B only

Negative spool position open connections to:

- P-B and A-T
- P-A and P-B
- P-B only

P-B orifice area vector — Vector of valve opening areas

[1e-10, 1e-05, 4e-05, 6e-05, .0001] m² (default) | 1-by-*n* vector

Vector of opening areas for the tabular parameterization of valve opening area. The vector elements must correspond one-to-one with the elements in the **P-B spool travel vector** parameter. The elements are listed in ascending order and must be greater than 0.

Dependencies

To enable this parameter, set:

- 1 **Area characteristics** to Different for each flow path.
- 2 **Orifice parameterization** to Tabulated data - Area vs. spool travel.
- 3 One of the following parameters:

Positive spool position open connections to:

- P-B and A-T
- P-A and P-B
- P-B only

Negative spool position open connections to:

- P-B and A-T
- P-A and P-B
- P-B only

P-B orifice spool travel vector, ds — Vector of spool opening distances relative to fully closed position

[0, .00125, .0025, .00375, .005] m (default) | 1-by-*n* vector

Vector of spool travel distances for the tabular parameterization of volumetric flow rates. The spool travel vector forms an independent axis with the **P-T orifice pressure drop vector, dp** parameter for the 2-D dependent **P-T orifice volumetric flow rate table, q(ds,dp)** parameter. The values are listed in ascending order and the first element must be 0. Linear interpolation is employed between table data points.

Dependencies

To enable this parameter, set:

- 1 **Area characteristics** to Different for each flow path.
- 2 **Orifice parameterization** to Tabulated data - Volumetric flow rate vs. spool travel and pressure drop.
- 3 One of the following parameters:

Positive spool position open connections to:

- P-B and A-T
- P-A and P-B
- P-B only

Negative spool position open connections to:

- P-B and A-T
- P-A and P-B
- P-B only

P-B orifice pressure drop vector, dp — Vector of pressure differential values

[-.1, .3, .5, .7] MPa (default) | 1-by-n vector

Vector of pressure drop values for tabular parametrization of volumetric flow rate. The pressure drop vector forms an independent axis with the **P-B orifice spool travel vector, ds** parameter for the 2-D dependent **P-B orifice volumetric flow rate table, $q(ds,dp)$** parameter. The values are listed in ascending order and must be greater than 0. Linear interpolation is employed between table data points.

Dependencies

To enable this parameter, set:

- 1 **Area characteristics** to Different for each flow path.
- 2 **Orifice parameterization** to Tabulated data - Volumetric flow rate vs. spool travel and pressure drop.
- 3 One of the following parameters:

Positive spool position open connections to:

- P-B and A-T
- P-A and P-B
- P-B only

Negative spool position open connections to:

- P-B and A-T
- P-A and P-B
- P-B only

P-B orifice volumetric flow rate table, $q(ds, dp)$ — Array of volumetric flow rate values

[-1e-08, 2.2e-08, 2.8e-08, 3.4e-08; -9e-06, .00015, .0002, .00024;
 -.00036, .00063, .00081, .00096; -.00054, .00094, .0012, .0014;
 -.00091, .0016, .002, .0024] m³/s (default) | *M*-by-*N* matrix

M-by-*N* matrix of volumetric flow rates based on independent values of pressure drop and spool travel distance. *M* and *N* are the sizes of the correlated vectors:

- *M* is the number of vector elements in the **P-B orifice pressure drop vector, dp** parameter.
- *N* is the number of vector elements in the **P-B orifice spool travel vector, ds** parameter.

Dependencies

To enable this parameter, set:

- 1 **Area characteristics** to Different for each flow path.
- 2 **Orifice parameterization** to Tabulated data - Volumetric flow rate vs. spool travel and pressure drop.
- 3 One of the following parameters:

Positive spool position open connections to:

- P-B and A-T
- P-A and P-B
- P-B only

Negative spool position open connections to:

- P-B and A-T
- P-A and P-B
- P-B only

P-B constant orifice area — Cross-sectional area for a constant orifice

1e-4 m² (default) | positive scalar

Orifice area when the positive and negative spool positions feature the same orifice.

Dependencies

To enable this parameter, set:

- 1 **Area characteristics** to Different for each flow path.
- 2 **Orifice parameterization** to either:
 - Linear - area vs. spool travel
 - Tabulated data - Area vs. spool travel
- 3 One of the following settings in each parameter:

Positive spool position open connections to:

- P-B and A-T

- P-A and P-B
- P-B only

Negative spool position open connections to:

- P-B and A-T
- P-A and P-B
- P-B only

P-B Constant orifice pressure drop vector — Vector of pressure differential values for a constant orifice

[-.1, .3, .5, .7] MPa (default) | 1-by-*n* vector

Vector of pressure differential values over the valve when the positive and negative spool positions feature the same orifice. The vector elements correspond one-to-one with the elements in the **P-B Constant orifice volumetric flow rate vector** parameter. The values are listed in ascending order. Linear interpolation is employed between table data points.

Dependencies

To enable this parameter, set:

- 1 Area characteristics** to Different for each flow path.
- 2 Orifice parameterization** to Tabulated data - Volumetric flow rate vs. spool travel and pressure drop.
- 3** One of the following settings in each parameter:

Positive spool position open connections to:

- P-B and A-T
- P-A and P-B
- P-B only

Negative spool position open connections to:

- P-B and A-T
- P-A and P-B
- P-B only

P-B Constant orifice volumetric flow rate vector — Vector of volumetric flow rate values for a constant orifice

[-.0009, .0016, .002, .0024] m³/s (default) | 1-by-*n* vector

Vector of volumetric flow rate values over the valve when the positive, neutral, and negative spool positions feature the same orifice. The vector elements correspond one-to-one with the elements in the **P-B Constant orifice pressure drop vector** parameter. The values are listed in ascending order. Linear interpolation is employed between table data points.

Dependencies

To enable this parameter, set:

- 1 Area characteristics** to Different for each flow path.

2 Orifice parameterization to Tabulated data - Volumetric flow rate vs. spool travel and pressure drop.

3 One of the following settings in each parameter:

Positive spool position open connections to:

- P-B and A-T
- P-A and P-B
- P-B only

Negative spool position open connections to:

- P-B and A-T
- P-A and P-B
- P-B only

A-T Orifice

Spool position at maximum A-T orifice area — Spool offset from the neutral position for a fully open A-T orifice

-5e-3 m (default) | positive scalar

Spool offset from the neutral position for a fully open A-T orifice. To visualize the defined offsets, see “Visualize Orifice Openings” on page 1-209.

Dependencies

To enable this parameter, set one of the following parameters:

- **Positive spool position open connections** to P-B and A-T.
- **Negative spool position open connections** to P-B and A-T.

Note: This parameter is enabled only when the A-T orifice settings do not appear in both spool position parameters: **Positive spool position open connections** and **Negative spool position open connections**.

A-T spool travel between closed and open orifice — Maximum spool stroke

0.005 m (default) | positive scalar

Maximum distance of spool travel. This value provides an upper limit to calculations so that simulations do not return unphysical values.

Dependencies

To enable this parameter, set:

- 1 Area characteristics** to Different for each flow path.
- 2 Orifice parameterization** to Linear - Area vs. spool travel.
- 3** One of the following parameters:

Positive spool position open connections to P-B and A-T

Negative spool position open connections to P-B and A-T.

A-T maximum orifice area — Maximum orifice opening area

1e-4 m² (default) | positive scalar

Largest open area of the A-T orifice during the operation of the valve.

Dependencies

To enable this parameter, set:

- 1 **Area characteristics** to Different for each flow path.
- 2 **Orifice parameterization** to Linear - Area vs. spool travel.
- 3 One of the following parameters:

Positive spool position open connections to P-B and A-T

Negative spool position open connections to P-B and A-T.

A-T orifice spool travel vector — Vector of spool opening distances relative to fully closed position

[0, .00125, .0025, .00375, .005] m (default) | 1-by-*n* vector

Vector of spool travel distances for the tabular parameterization of valve area. The vector elements must correspond one-to-one with the elements in the **A-T orifice area vector** parameter. The values are listed in ascending order and the first element must be 0. Linear interpolation is employed between table data points.

Dependencies

To enable this parameter, set:

- 1 **Area characteristics** to Different for each flow path.
- 2 **Orifice parameterization** to Tabulated data - Area vs. spool travel.
- 3 One of the following parameters:

Positive spool position open connections to P-B and A-T.

Negative spool position open connections to P-B and A-T.

A-T orifice spool travel vector — Vector of spool opening distances relative to fully closed position

[0, .00125, .0025, .00375, .005] m (default) | 1-by-*n* vector

Vector of spool travel distances for the tabular parameterization of valve area. The vector elements must correspond one-to-one with the elements in the **A-T orifice area vector** parameter. The values are listed in ascending order and the first element must be 0. Linear interpolation is employed between table data points.

Dependencies

To enable this parameter, set:

- 1 **Area characteristics** to Different for each flow path.
- 2 **Orifice parameterization** to Tabulated data - Area vs. spool travel.

3 One of the following parameters:

Positive spool position open connections to P-B and A-T.

Negative spool position open connections to P-B and A-T.

A-T orifice spool travel vector, ds – Vector of spool opening distances relative to fully closed position

[0, .00125, .0025, .00375, .005] m (default) | 1-by- n vector

Vector of spool travel distances for the tabular parameterization of volumetric flow rates. The spool travel vector forms an independent axis with the **A-T orifice pressure drop vector, dp** parameter for the 2-D dependent **A-T orifice volumetric flow rate table, $q(ds,dp)$** parameter. The values are listed in ascending order and the first element must be 0. Linear interpolation is employed between table data points.

Dependencies

To enable this parameter, set:

- 1 **Area characteristics** to Different for each flow path.
- 2 **Orifice parameterization** to Tabulated data - Volumetric flow rate vs. spool travel and pressure drop.
- 3 One of the following parameters:

Positive spool position open connections to P-B and A-T.

Negative spool position open connections to P-B and A-T.

A-T orifice pressure drop vector, dp – Vector of pressure differential values

[-.1, .3, .5, .7] MPa (default) | 1-by- n vector

Vector of pressure drop values for tabular parametrization of volumetric flow rate. The pressure drop vector forms an independent axis with the **A-T orifice spool travel vector, ds** parameter for the 2-D dependent **A-T orifice volumetric flow rate table, $q(ds,dp)$** parameter. The values are listed in ascending order and must be greater than 0. Linear interpolation is employed between table data points.

Dependencies

To enable this parameter, set:

- 1 **Area characteristics** to Different for each flow path.
- 2 **Orifice parameterization** to Tabulated data - Volumetric flow rate vs. spool travel and pressure drop.
- 3 One of the following parameters:

Positive spool position open connections to P-B and A-T.

Negative spool position open connections to P-B and A-T.

A-T orifice volumetric flow rate table, $q(ds, dp)$ — Array of volumetric flow rate values

[-1e-08, 2.2e-08, 2.8e-08, 3.4e-08; -9e-06, .00015, .0002, .00024;
 -.00036, .00063, .00081, .00096; -.00054, .00094, .0012, .0014;
 -.00091, .0016, .002, .0024] m³/s (default) | *M*-by-*N* matrix

M-by-*N* matrix of volumetric flow rates based on independent values of pressure drop and spool travel distance. *M* and *N* are the sizes of the correlated vectors:

- *M* is the number of vector elements in the **A-T orifice pressure drop vector, dp** parameter.
- *N* is the number of vector elements in the **A-T orifice spool travel vector, ds** parameter.

Dependencies

To enable this parameter, set:

- 1 **Area characteristics** to Different for each flow path.
- 2 **Orifice parameterization** to Tabulated data - Volumetric flow rate vs. spool travel and pressure drop.
- 3 One of the following parameters:

Positive spool position open connections to P-B and A-T.

Negative spool position open connections to P-B and A-T.

A-T constant orifice area — Cross-sectional area for a constant orifice

1e-4 m² (default) | positive scalar

Orifice area when the positive and negative spool positions feature the same orifice.

Dependencies

To enable this parameter, set:

- 1 **Area characteristics** to Different for each flow path.
- 2 **Orifice parameterization** to either:
 - Linear - area vs. spool travel
 - Tabulated data - Area vs. spool travel
- 3 One of the following settings in each parameter:

Positive spool position open connections to P-B and A-T.

Negative spool position open connections to P-B and A-T.

A-T Constant orifice pressure drop vector — Vector of pressure differential values for a constant orifice

[-.1, .3, .5, .7] MPa (default) | 1-by-*n* vector

Vector of pressure differential values over the valve when the positive, neutral, and negative spool positions feature the same orifice. The vector elements correspond one-to-one with the elements in the **A-T Constant orifice volumetric flow rate vector** parameter. The values are listed in ascending order. Linear interpolation is employed between table data points.

Dependencies

To enable this parameter, set:

- 1 **Area characteristics** to Different for each flow path.
- 2 **Orifice parameterization** to Tabulated data - Volumetric flow rate vs. spool travel and pressure drop.
- 3 One of the following settings in each parameter:

Positive spool position open connections to P-B and A-T.

Negative spool position open connections to P-B and A-T.

A-T Constant orifice volumetric flow rate vector – Vector of volumetric flow rate values for a constant orifice

$[-.0009, .0016, .002, .0024]$ m³/s (default) | 1-by-*n* vector

Vector of volumetric flow rate values when the positive, neutral, and negative spool positions feature the same orifice. The vector elements correspond one-to-one with the elements in the **Constant orifice volumetric flow rate vector** parameter. The values are listed in ascending order. Linear interpolation is employed between table data points.

Dependencies

To enable this parameter, set:

- 1 **Area characteristics** to Different for each flow path.
- 2 **Orifice parameterization** to Tabulated data - Volumetric flow rate vs. spool travel and pressure drop.
- 3 One of the following settings in each parameter:

Positive spool position open connections to P-B and A-T.

Negative spool position open connections to P-B and A-T.

B-T Orifice**Spool position at maximum B-T orifice area – Spool offset from the neutral position for a fully open B-T orifice**

$5e-3$ m (default) | positive scalar

Spool offset from the neutral position for a fully open B-T orifice. To visualize the defined offsets, see “Visualize Orifice Openings” on page 1-209.

Dependencies

To enable this parameter, set one of the following parameters:

- **Positive spool position open connections** to P-A and B-T.
- **Negative spool position open connections** to P-A and B-T.

Note: This parameter is enabled only when the B-T orifice settings do not appear in both spool position parameters: **Positive spool position open connections** and **Negative spool position open connections**.

B-T spool travel between closed and open orifice — Maximum spool stroke

0.005 m (default) | positive scalar

Maximum distance of spool travel. This value provides an upper limit to calculations so that simulations do not return unphysical values.

Dependencies

To enable this parameter, set:

- 1 **Area characteristics** to Different for each flow path.
- 2 **Orifice parameterization** to Linear - Area vs. spool travel.
- 3 One of the following parameters:

Positive spool position open connections to P-A and B-T.

Negative spool position open connections to P-A and B-T.

B-T maximum orifice area — Maximum orifice opening area

1e-4 m² (default) | positive scalar

Largest open area of the B-T orifice during the operation of the valve.

Dependencies

To enable this parameter, set:

- 1 **Area characteristics** to Different for each flow path.
- 2 **Orifice parameterization** to Linear - Area vs. spool travel.
- 3 One of the following parameters:

Positive spool position open connections to P-A and B-T.

Negative spool position open connections to P-A and B-T.

B-T orifice spool travel vector — Vector of spool opening distances relative to fully closed position

[0, .00125, .0025, .00375, .005] m (default) | 1-by-n vector

Vector of spool travel distances for the tabular parameterization of valve area. The vector elements must correspond one-to-one with the elements in the **B-T orifice area vector** parameter. The values are listed in ascending order and the first element must be 0. Linear interpolation is employed between table data points.

Dependencies

To enable this parameter, set:

- 1 **Area characteristics** to Different for each flow path.
- 2 **Orifice parameterization** to Tabulated data - Area vs. spool travel.
- 3 One of the following parameters:

Positive spool position open connections to P-A and B-T.

Negative spool position open connections to P-A and B-T.

B-T orifice area vector – Vector of valve opening areas[1e-10, 1e-05, 4e-05, 6e-05, .0001] m² (default) | 1-by-n vector

Vector of opening areas for the tabular parameterization of valve opening area. The vector elements must correspond one-to-one with the elements in the **B-T orifice spool travel vector** parameter. The elements are listed in ascending order and must be greater than 0.

Dependencies

To enable this parameter, set:

- 1 **Area characteristics** to Different for each flow path.
- 2 **Orifice parameterization** to Tabulated data - Area vs. spool travel.
- 3 One of the following parameters:

Positive spool position open connections to P-A and B-T.

Negative spool position open connections to P-A and B-T.

B-T orifice spool travel vector, ds – Vector of spool opening distances relative to fully closed position

[0, .00125, .0025, .00375, .005] m (default) | 1-by-n vector

Vector of control member travel distances for the tabular parameterization of volumetric flow rates. The spool travel vector forms an independent axis with the **B-T orifice pressure drop vector, dp** parameter for the 2-D dependent **B-T orifice volumetric flow rate table, q(ds,dp)** parameter. The values are listed in ascending order and the first element must be 0. Linear interpolation is employed between table data points.

Dependencies

To enable this parameter, set:

- 1 **Area characteristics** to Different for each flow path.
- 2 **Orifice parameterization** to Tabulated data - Volumetric flow rate vs. spool travel and pressure drop.
- 3 One of the following parameters:

Positive spool position open connections to P-A and B-T.

Negative spool position open connections to P-A and B-T.

B-T orifice pressure drop vector, dp – Vector of pressure differential values

[-.1, .3, .5, .7] MPa (default) | 1-by-n vector

Vector of pressure drop values for tabular parametrization of volumetric flow rate. The pressure drop vector forms an independent axis with the **B-T orifice spool travel vector, ds** parameter for the 2-D dependent **B-T orifice volumetric flow rate table, q(ds,dp)** parameter. The values are listed in ascending order and must be greater than 0. Linear interpolation is employed between table data points.

Dependencies

To enable this parameter, set:

- 1 Area characteristics** to Different for each flow path.
- 2 Orifice parameterization** to Tabulated data - Volumetric flow rate vs. spool travel and pressure drop.
- 3** One of the following parameters:

Positive spool position open connections to P-A and B-T.

Negative spool position open connections to P-A and B-T.

B-T orifice volumetric flow rate table, $q(ds, dp)$ — Array of volumetric flow rate values

`[-1e-08, 2.2e-08, 2.8e-08, 3.4e-08; -9e-06, .00015, .0002, .00024; -.00036, .00063, .00081, .00096; -.00054, .00094, .0012, .0014; -.00091, .0016, .002, .0024] m3/s (default) | M-by-N matrix`

M-by-*N* matrix of volumetric flow rates based on independent values of pressure drop and spool travel distance. *M* and *N* are the sizes of the correlated vectors:

- *M* is the number of vector elements in the **B-T orifice pressure drop vector, dp** parameter.
- *N* is the number of vector elements in the **B-T orifice spool travel vector, ds** parameter.

Dependencies

To enable this parameter, set:

- 1 Area characteristics** to Different for each flow path.
- 2 Orifice parameterization** to Tabulated data - Volumetric flow rate vs. spool travel and pressure drop.
- 3** One of the following parameters:

Positive spool position open connections to P-A and B-T.

Negative spool position open connections to P-A and B-T.

B-T constant orifice area — Cross-sectional orifice area for constant orifices

`1e-4 m2 (default) | positive scalar`

Orifice area when the positive and negative spool positions feature the same orifice.

Dependencies

To enable this parameter, set:

- 1 Area characteristics** to Different for each flow path.
- 2 Orifice parameterization** to either:
 - Linear - area vs. spool travel
 - Tabulated data - Area vs. spool travel
- 3** One of the settings in each parameter:

Positive spool position open connections to P-A and B-T.

Negative spool position open connections to P-A and B-T.

B-T Constant orifice pressure drop vector – Vector of pressure differential values for a constant orifice[-.1, .3, .5, .7] MPa (default) | 1-by-*n* vector

Vector of pressure differential values over the valve when the positive and negative spool positions feature the same orifice. The vector elements correspond one-to-one with the elements in the **B-T Constant orifice volumetric flow rate vector** parameter. The values are listed in ascending order. Linear interpolation is employed between table data points.

Dependencies

To enable this parameter, set:

- 1 **Area characteristics** to Different for each flow path.
- 2 **Orifice parameterization** to Tabulated data - Volumetric flow rate vs. spool travel and pressure drop.
- 3 One of the settings in each parameter:

Positive spool position open connections to P-A and B-T.

Negative spool position open connections to P-A and B-T.

B-T Constant orifice volumetric flow rate vector – Vector of volumetric flow rates for a constant orifice[-.0009, .0016, .002, .0024] m³/s (default) | 1-by-*n* vector

Vector of pressure differential values over the valve when the positive and negative spool positions feature the same orifice. The vector elements correspond one-to-one with the elements in the **B-T Constant orifice pressure drop vector** parameter. The values are listed in ascending order. Linear interpolation is employed between table data points.

Dependencies

To enable this parameter, set:

- 1 **Area characteristics** to Different for each flow path.
- 2 **Orifice parameterization** to Tabulated data - Volumetric flow rate vs. spool travel and pressure drop.
- 3 One of the settings in each parameter:

Positive spool position open connections to P-A and B-T.

Negative spool position open connections to P-A and B-T.

Faults**Enable faults – Fault option**

Off (default) | On

Enable externally or temporally triggered faults. When faulting occurs, the valve area normally set by the opening parameterization will be set to the value specified in the **Spool position when faulted** parameter.

Spool position when faulted – Set faulted characteristics

Positive (default) | Negative | Maintain last value

Sets the faulted valve spool position. You can choose for the valve to seize when the spool is in the positive position, negative position, or at the position when faulting is triggered.

Dependencies

To enable this parameter, set **Enable faults** to On.

Fault trigger – External or temporal trigger option

Temporal (default) | External

Whether a fault trigger occurs due to an external event or at a specified time.

When set to External, port **Tr** is enabled. A physical signal at port **Tr** that is greater than 0.5 triggers faulting.

When set to Temporal, when the **Simulation time for fault event** is reached, the valve area will be set to the value specified in the **Spool position when faulted** parameter.

Dependencies

To enable this parameter, set **Enable faults** to On.

Simulation time for fault event – Time at which faulting is triggered

5 s (default) | positive scalar

When the **Simulation time for fault event** is reached, the valve area is set to the value specified in the **Spool position when faulted** parameter.

Dependencies

To enable this parameter, set **Enable faults** to On and **Fault trigger** to Temporal.

See Also

4-Way 3-Position Directional Valve (IL) | 3-Way Directional Valve (IL) | 2-Way Directional Valve (IL)

Introduced in R2021a

4-Way Directional Valve (TL)

Valve for routing flow at the junction of four lines

Library: Simscape / Fluids / Thermal Liquid / Valves & Orifices / Directional Control Valves

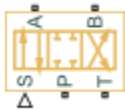

Description

The 4-Way Directional Valve block models the flow through a directional control valve with four ports (**P**, **T**, **A**, and **B**) and four flow paths (**P-A**, **P-B**, **A-T**, and **B-T**). The ports connect to what in a typical system are a pump (**P**), a tank (**T**), and a double-acting actuator (**A** and **B**). The paths each contain a variable orifice, which scales in proportion to the displacement of a control member—often a ball, spool, or diaphragm, associated with the signal at port **S**. This valve serves as a switch by which to partition the flow between the arms of a four-pronged junction.

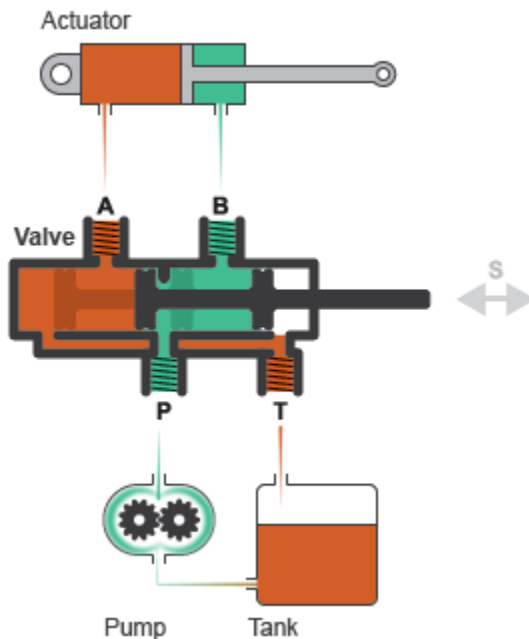

Typical Valve Setup

Valve Positions

The valve is continuously variable. It shifts smoothly between positions, of which it has three. One—the *normal* position—is that to which the valve reverts when its control signal falls to zero. Unless opening offsets have been specified, the valve orifices are always fully closed in this position. Two—the *working* positions—are those to which the valve moves when (the absolute value) of its control

signal rises to a maximum. Two orifices are generally fully closed and another two fully open when the valve is in a working position. Note that whether an orifice is in fact open and how open it is both depend on the opening offsets of the valve.

The working positions are shown in the figure in the default case of a valve without opening offsets. One, labeled **I**, corresponds to the **P-A** and **B-T** orifices being maximally open and the **P-B** and **A-T** orifices maximally closed. The other, labeled **II**, corresponds to the reverse arrangement, with the **P-B** and **A-T** orifices being maximally open and the **P-A** and **B-T** orifices maximally closed. At points between the normal and working positions, one orifice is partially open while the other is fully closed. Note that no connection exists between ports **A** and **B** nor between **P** and **T** and that no flow can develop across them.

I.

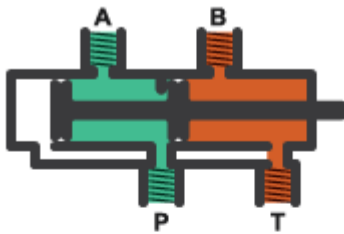

II.

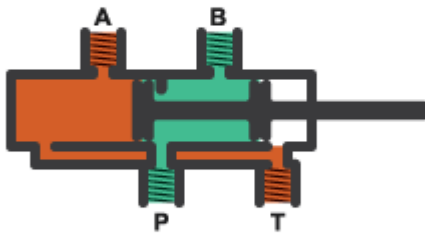

III.

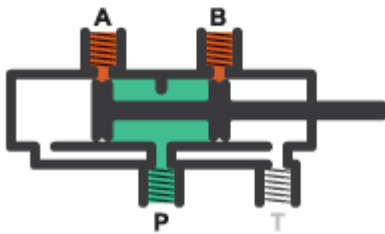

Valve Opening

Which position the valve is in depends on the control member coordinates relative to the **P-A**, **P-B**, **A-T**, and **B-T** orifices—lengths referred to here as the *orifice openings*. These are calculated during simulation from their opening offsets, each specified as a block parameter in the block dialog box, and from the control member displacement, given by the physical signal at port **S**. For the **P-A** and **B-T** orifices:

$$h_{PA} = h_{PA0} + x \text{ and } h_{BT} = h_{BT0} + x,$$

where:

- h_{PA} and h_{BT} are the **P-A** and **B-T** orifice openings.
- h_{PA0} and h_{BT0} are the **P-A** and **B-T** opening offsets.
- x is the control member displacement. Note that a control member displacement of zero corresponds to a valve in its normal state.

For the **P-B** and **A-T** orifices:

$$h_{PB} = h_{PB0} + x \text{ and } h_{AT} = h_{AT0} + x,$$

where:

- h_{PB} and h_{AT} are the **P-B** and **A-T** orifice openings.
- h_{PB0} and h_{AT0} are the **P-B** and **A-T** opening offsets.

An orifice cracks opens when its calculated opening (variable h) rises above zero. It then continues to widen with a rising opening value. In the cases of the **P-B** and **A-T** orifices, it occurs as the control member is displaced in the negative direction.

The orifices are each fully open when the opening value is at a specified maximum. In the linear valve parameterization, this maximum is obtained from the **Maximum valve opening** block parameter. You can set the **Area characteristics** parameter to **Different** for each flow path to specify the **Maximum valve opening** parameter separately for each orifice. In tabulated valve parameterizations, the maximum opening is obtained from the last breakpoint specified in the tabulated data.

Opening Offsets

The opening offsets are by default zero, a configuration that leaves the orifices each closed in the normal valve position. A valve so configured is said to be *zero-lapped*, a reference to the fact that the control member is exactly sized to prevent flow through any orifice when idle, or unactuated ($x = 0$). For the purposes of this block, the opening offsets can be conceived as the natural distances between the lands of the (unactuated) control member and the orifices that they are to cover.

Other valve configurations are possible. A valve can be *underlapped*, for example, or *overlapped*—terms indicative of the mismatch between the dimensions of the control member and those of the valve orifices. The valve is underlapped if its orifices are each partially open in the normal position. Such a valve allows a weak flow to develop across all paths simultaneously. The valve is overlapped if its orifices are each closed not only in the normal position but also over a small range of control member displacements around it.

The figure shows a representative valve in three configurations:

- **Case I:** A zero-lapped valve. The opening offsets are both zero. When the valve is in the normal position, the control member completely covers both orifices. The zero-lapped valve is completely closed when the control member displacement is exactly zero.
- **Case II:** An underlapped valve. The opening offsets are both positive. When the valve is in the normal position, the control member covers both orifices but neither fully. The underlapped valve is always at least partially open.
- **Case III:** An overlapped valve. The opening offsets are both negative. The control member completely covers both orifices not only in the normal position but also over a small region around

it. The overlapped valve is fully closed until the control member crosses the opening offset of either orifice.

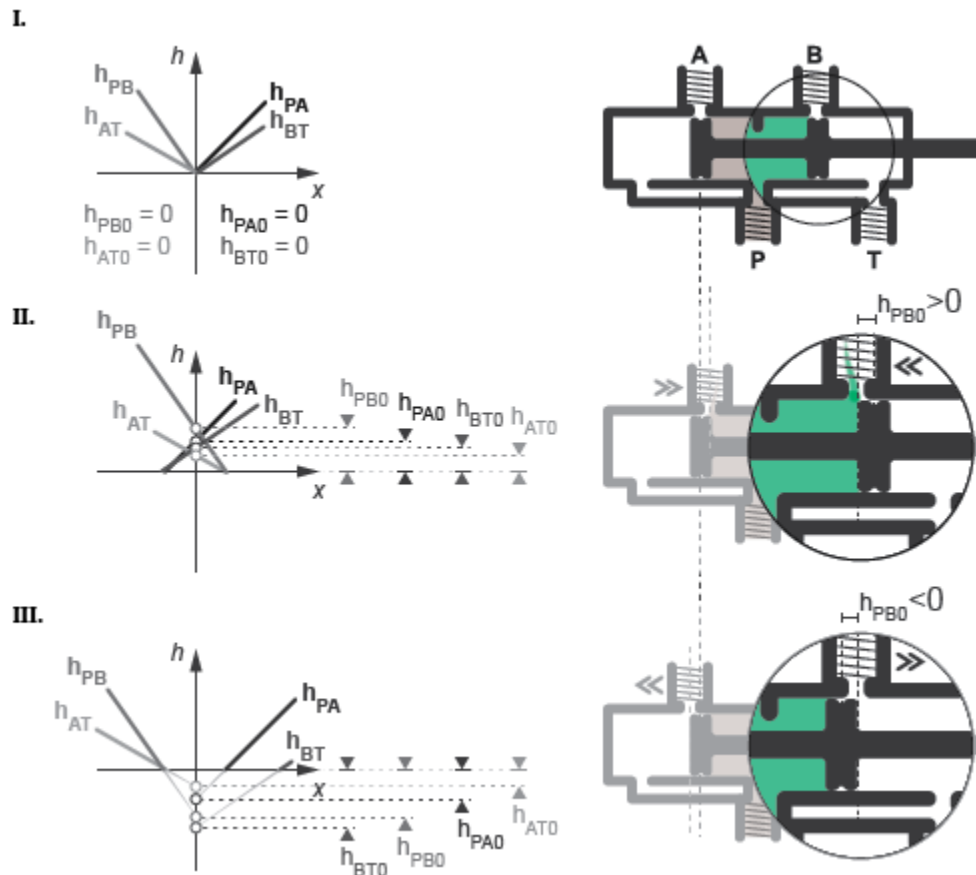

The table summarizes the configurations that the valve can take on and the opening offsets that characterize them. Use the block parameters in the **Valve opening offsets** tab to change the offsets if needed.

The 4-Way Directional Valve Configurations

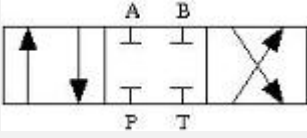
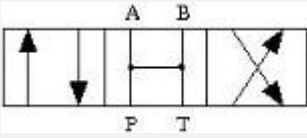
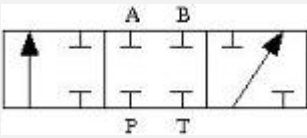
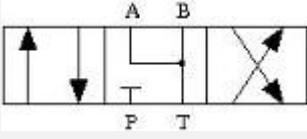
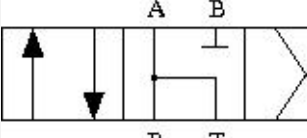
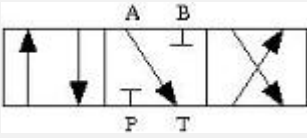
No	Configuration	Initial Openings
1		<p>All four orifices are overlapped in neutral position:</p> <ul style="list-style-type: none"> • Orifice P-A initial opening < 0 • Orifice P-B initial opening < 0 • Orifice A-T initial opening < 0 • Orifice B-T initial opening < 0
2		<p>All four orifices are open (underlapped) in neutral position:</p> <ul style="list-style-type: none"> • Orifice P-A initial opening > 0 • Orifice P-B initial opening > 0 • Orifice A-T initial opening > 0 • Orifice B-T initial opening > 0
3		<p>Orifices P-A and P-B are overlapped. Orifices A-T and B-T are overlapped for more than valve stroke:</p> <ul style="list-style-type: none"> • Orifice P-A initial opening < 0 • Orifice P-B initial opening < 0 • Orifice A-T initial opening < - <i>valve_stroke</i> • Orifice B-T initial opening < - <i>valve_stroke</i>
4		<p>Orifices P-A and P-B are overlapped, while orifices A-T and B-T are open:</p> <ul style="list-style-type: none"> • Orifice P-A initial opening < 0 • Orifice P-B initial opening < 0 • Orifice A-T initial opening > 0 • Orifice B-T initial opening > 0
5		<p>Orifices P-A and A-T are open in neutral position, while orifices P-B and B-T are overlapped:</p> <ul style="list-style-type: none"> • Orifice P-A initial opening > 0 • Orifice P-B initial opening < 0 • Orifice A-T initial opening > 0 • Orifice B-T initial opening < 0
6		<p>Orifice A-T is initially open, while all three remaining orifices are overlapped:</p> <ul style="list-style-type: none"> • Orifice P-A initial opening < 0 • Orifice P-B initial opening < 0 • Orifice A-T initial opening > 0 • Orifice B-T initial opening < 0

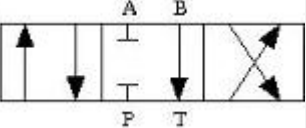
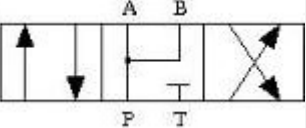
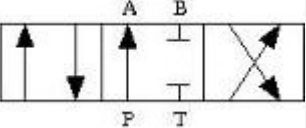
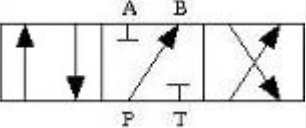
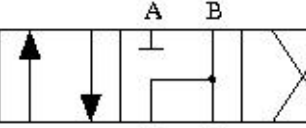
No	Configuration	Initial Openings
7		<p>Orifice B-T is initially open, while all three remaining orifices are overlapped:</p> <ul style="list-style-type: none"> • Orifice P-A initial opening < 0 • Orifice P-B initial opening < 0 • Orifice A-T initial opening < 0 • Orifice B-T initial opening > 0
8		<p>Orifices P-A and P-B are open, while orifices A-T and B-T are overlapped:</p> <ul style="list-style-type: none"> • Orifice P-A initial opening > 0 • Orifice P-B initial opening > 0 • Orifice A-T initial opening < 0 • Orifice B-T initial opening < 0
9		<p>Orifice P-A is initially open, while all three remaining orifices are overlapped:</p> <ul style="list-style-type: none"> • Orifice P-A initial opening > 0 • Orifice P-B initial opening < 0 • Orifice A-T initial opening < 0 • Orifice B-T initial opening < 0
10		<p>Orifice P-B is initially open, while all three remaining orifices are overlapped:</p> <ul style="list-style-type: none"> • Orifice P-A initial opening < 0 • Orifice P-B initial opening > 0 • Orifice A-T initial opening < 0 • Orifice B-T initial opening < 0
11		<p>Orifices P-B and B-T are open, while orifices P-A and A-T are overlapped:</p> <ul style="list-style-type: none"> • Orifice P-A initial opening < 0 • Orifice P-B initial opening > 0 • Orifice A-T initial opening < 0 • Orifice B-T initial opening > 0

Opening Characteristics

The orifice openings serve during simulation to calculate the mass flow rates through the orifices. The calculation can be a direct mapping from opening to flow rate or an indirect conversion, first from opening to orifice area and then from orifice area to mass flow rate. The calculation, and the data required for it, depend on the setting of the **Valve parameterization** block parameter:

- **Linear area-opening relationship** — Calculate the valve opening area from the control member position and from it obtain the mass flow rate through the valve. The opening area is

assumed to vary linearly with the control member position. The slope of the linear expression is determined from the **Maximum valve opening** and **Maximum opening area** block parameters.

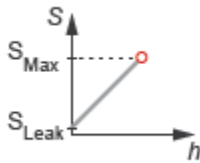

- **Tabulated data - Area vs. opening** — Calculate the valve opening area from the control member position and from it obtain the mass flow rate through the valve. The opening area can vary nonlinearly with the control member position. The relationship between the two is given by the tabulated data in the **Valve opening vector** and **Opening area vector** block parameters.

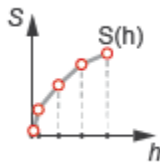

- **Tabulated data - Mass flow rate vs. opening and pressure drop** — Calculate the mass flow rate directly from the control member position and the pressure drop across the valve. The relationship between the three variables can be nonlinear and it is given by the tabulated data in the **Valve opening vector**, **Pressure drop vector**, and **Mass flow rate table** block parameters.

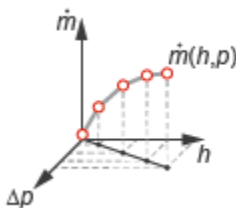

Leakage Flow

The primary purpose of the leakage flow rate of a closed valve is to ensure that at no time a portion of the thermal liquid network becomes isolated from the remainder of the model. Such isolated portions reduce the numerical robustness of the model and can slow down simulation or cause it to fail. Leakage flow is generally present in real valves but in a model its exact value is less important than its being a small number greater than zero. The leakage flow rate is determined from the **Leakage area** block parameter.

Pressure Loss and Recovery

The pressure drop in the valve is calculated from an empirical parameter known as the discharge coefficient (obtained from the **Discharge coefficient** block parameter). The calculation captures the effect of flow regime, with the pressure drop being proportional to the mass flow rate when the flow is laminar and to the square of the same when the flow is turbulent. Also captured is the pressure recovery than in real valves occurs between the vena contracta (the narrowest aperture of the valve) and the outlet, which generally lies a small distance away.

Composite Component Structure

This block is a composite component comprising four Variable Area Orifice (TL) blocks connected as shown in the figure. A single control signal actuates the four blocks simultaneously. The **Orifice orientation** block parameters are set so that a positive signal acts to open the **P-A** and **B-T** orifices while closing the **P-B** and **A-T** orifices. The specified opening offsets are each applied to the block representing the intended orifice. Refer to the Variable Area Orifice (TL) block for detail on the opening area calculations.

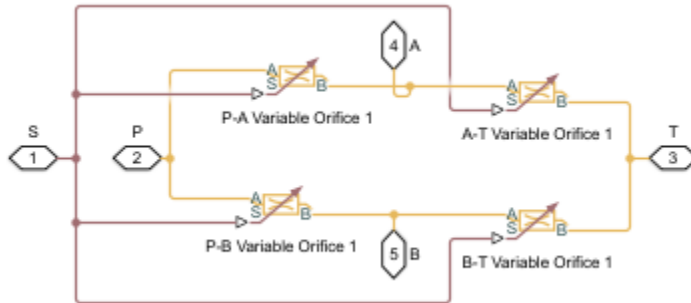

Ports

Input

S – Control member displacement, unitless

physical signal

Instantaneous displacement of the valve control member.

Conserving

P – Flow passage

thermal liquid

Opening through which the flow can enter or exit the valve. This port is typically connected to a fluid supply line.

T – Flow passage

thermal liquid

Opening through which the flow can enter or exit the valve. This port is typically connected to a fluid return line.

A – Flow passage

thermal liquid

Opening through which the flow can enter or exit the valve. This port is typically connected to an actuation line.

B – Flow passage

thermal liquid

Opening through which the flow can enter or exit the valve. This port is typically connected to an actuation line.

Parameters

Basic Parameters

Area characteristics — Choice of identical or different orifice opening characteristics

Identical for all flow paths (default) | Different for each flow path

Assumption to make in the opening characteristics of the valve orifices. The default setting attributes the same opening characteristics to each orifice. The maximum opening area and the orifice opening at which it occurs are then the same for all orifices. Use the alternate setting to specify these parameters separately for each orifice.

Valve parameterization — Method by which to model the opening characteristics of the valve

Linear area-opening relationship (default) | Tabulated data - Area vs. opening | Tabulated data - Mass flow rate vs. opening and pressure drop

Method by which to model the opening characteristics of the valve. The default setting prescribes a linear relationship between the valve opening area and the valve opening. The alternative settings allow for a general, nonlinear relationship to be specified in tabulated form, in one case between the opening area and the control member position (the valve opening), in the other case between the mass flow rate and both the valve opening and the pressure drop between the ports.

Leakage area — Opening area of the valve in the maximally closed position

$1e-10 \text{ m}^2$ (default) | positive scalar in units of area

Opening area of the valve in the fully closed position, when only internal leakage between its ports remains. This parameter serves primarily to ensure that closure of the valve does not cause portions of the thermal liquid network to become isolated. The exact value specified here is less important than its being a small number greater than zero.

Dependencies

This parameter is active when the **Valve parameterization** block parameter is set to Linear area-opening relationship.

Cross-sectional area at ports A, B, P, and T — Flow area at the thermal liquid ports

0.01 m (default) | positive scalar in units of area

Area normal to the flow path at each port. The ports are assumed to be equal in size. The flow area specified here should match those of the inlets of those components to which the valve connects.

Characteristic longitudinal length — Measure of the length of the flow path through the valve

0.1 (default) | positive scalar in units of length

Average distance traversed by the fluid as it travels from inlet to outlet. This distance is used in the calculation of the internal thermal conduction that occurs between the two ports (as part of the smoothed upwind energy scheme employed in the thermal liquid domain).

Discharge coefficient — Empirical factor defined as the ratio of actual to ideal mass flow rates

0.7 (default) | positive unitless scalar

Ratio of the actual flow rate through the valve to the theoretical value that it would have in an ideal valve. This semi-empirical parameter measures the flow allowed through the valve: the greater its value, the greater the flow rate. Refer to the valve data sheet, if available, for this parameter.

Critical Reynolds number — Reynolds number at the boundary between laminar and turbulent flow regimes

12 (default) | positive unitless scalar

Reynolds number at which the flow is assumed to transition between laminar and turbulent regimes.

Model Parameterization

Maximum valve opening — Control member position at which the opening area is at a maximum

5e-3 m (default) | positive scalar in units of length

Value of the orifice opening at which an orifice is considered to be fully open. The opening area of the orifice is then at a maximum. The maximum opening is used to calculate the slope of the linear expression relating the orifice opening area to the orifice opening.

Dependencies

This parameter is active when the **Valve parameterization** block parameter is set to Linear area-opening relationship.

Maximum opening area — Opening area of the valve in the fully open position

1e-4 m² (default) | positive scalar in units of area

Opening area of an orifice when its orifice opening has the value specified in the **Maximum valve opening** block parameter. The maximum opening area parameter is used to calculate the slope of the linear expression relating the orifice opening area to the orifice opening.

Dependencies

This parameter is active when the **Valve parameterization** block parameter is set to Linear area-opening relationship.

Smoothing factor — Measure of the amount of smoothing to apply to the opening area function

0.01 (default) | positive unitless scalar

Measure of the amount of smoothing to apply to the opening area function. This parameter determines the widths of the regions to be smoothed, one being at the fully open position, the other at the fully closed position. The smoothing superposes on the linear opening area function two nonlinear segments, one for each region of smoothing. The greater the value specified, the greater the smoothing and the broader the nonlinear segments.

Dependencies

This parameter is active when the **Valve parameterization** block parameter is set to Linear area-opening relationship.

Valve opening vector — Vector of control member positions at which to tabulate the valve opening areas

[-0.002, 0, 0.002, 0.005, 0.015] m (default) | vector of positive numbers in units of length

Vector of control member positions at which to specify—dependent on the valve parameterization—the opening area of the valve or its mass flow rate. The vector elements must increase monotonically from left to right. This vector must be equal in size to that specified in the **Opening area vector** block parameter or to the number of rows in the **Mass flow rate table** block parameter.

This data serves to construct a one-way lookup table by which to determine, from the control member position, the opening area of the valve or a two-way lookup table by which to determine, from the control member position and pressure drop, the mass flow rate of the valve. Data is handled with linear interpolation (within the tabulated data range) and nearest-neighbor extrapolation (outside of the data range).

Dependencies

This parameter is active when the **Valve parameterization** block parameter is set to Tabulated data - Area vs. opening.

Opening area vector — Vector of opening areas at the specified valve opening breakpoints

[1e-09, 2.0352e-07, 4.0736e-05, 0.00011438, 0.00034356] m² (default) | vector of positive numbers in units of area

Vector of opening areas corresponding to the breakpoints defined in the **Valve opening vector** block parameter. The vector elements must increase monotonically from left to right (with increasing control member position). This vector must be equal in size to the number of valve opening breakpoints.

This data serves to construct a one-way lookup table by which to determine from the control member position the opening area of the valve. Data is handled with linear interpolation (within the tabulated data range) and nearest-neighbor extrapolation (outside of the data range).

Dependencies

This parameter is active when the **Valve parameterization** block parameter is set to Tabulated data - Area vs. opening.

Pressure drop vector — Vector of pressure drops at which to tabulate the mass flow rates

[-0.1, 0.3, 0.5, 0.7] MPa (default) | vector in units of pressure

Vector of pressure differentials from port **A** to port **B** at which to specify the mass flow rate of the valve. The vector elements must increase monotonically from left to right. This vector must be equal in size to the number of columns in the **Mass flow rate table** block parameter.

This data serves to construct a two-way lookup table by which to determine, from the control member position and pressure drop, the opening area of the valve. Data is handled with linear interpolation (within the tabulated data range) and nearest-neighbor extrapolation (outside of the data range).

Dependencies

This parameter is active when the **Valve parameterization** block parameter is set to Tabulated data - Mass flow rate vs. opening and pressure drop.

Mass flow rate table — Matrix of mass flow rates at the specified valve opening and pressure drop breakpoints

[-1e-05, 1.7e-05, 2e-05, 2.6e-05; -.002, .0035, .0045, .0053; -.4, .7, .9, 1.06; -1.13, 1.96, 2.5, 3; -3.45, 6, 7.7, 9.13] kg/s (default) | matrix in units of mass/time

Matrix of mass flow rates corresponding to the breakpoints defined in the **Valve opening vector** and **Pressure drop vector** block parameters. The control member position increases from row to row from top to bottom. The pressure drop increases from column to column from left to right. The mass flow rate must increase monotonically in the same directions (with increasing control member position and increasing pressure drop).

This data serves to construct a two-way lookup table by which to determine, from the control member position and pressure drop, the opening area of the valve. Data is handled with linear interpolation (within the tabulated data range) and nearest-neighbor extrapolation (outside of the data range). Ensure that the number of rows is equal to the size of the **Opening area vector** block parameter and that the number of columns is equal to the size of the **Pressure drop vector** block parameter.

Dependencies

This parameter is active when the **Valve parameterization** block parameter is set to Tabulated data - Mass flow rate vs. opening and pressure drop.

Reference inflow temperature — Inlet temperature at which to specify the tabulated data

293.15 K (default) | positive scalar in units of temperature

Nominal inlet temperature, with reference to absolute zero, at which to specify the tabulated data. This parameter is used to adjust the mass flow rate according to the temperature measured during simulation.

Dependencies

This parameter is active when the **Valve parameterization** block parameter is set to Tabulated data - Mass flow rate vs. opening and pressure drop.

Reference inflow pressure — Inlet pressure at which to specify the tabulated data

0.101325 MPa (default) | positive scalar in units of pressure

Nominal inlet pressure, with reference to absolute zero, at which to specify the tabulated data. This parameter is used to adjust the mass flow rate according to the pressure measured during simulation.

Dependencies

This parameter is active when the **Valve parameterization** block parameter is set to Tabulated data - Mass flow rate vs. opening and pressure drop.

Valve Opening Offsets**Between P and A — Control member offset from the centered position relative to the P-A orifice**

0 m (default) | positive scalar in units of length

Distance by which to offset the valve control member from its centered (zero) position relative to the **P-A** orifice. This parameter determines the control member *displacement*, specified via port **S**, at which the **P-A** orifice is fully closed. Note that the control member *position* at which the valve is fully

closed is always at zero. Set all opening offsets to positive values to model an underlapped valve or to negative values to model an overlapped valve.

Between B and T – Control member offset from the centered position relative to the P-A orifice

0 m (default) | positive scalar in units of length

Distance by which to offset the valve control member from its centered (zero) position relative to the **B-T** orifice. This parameter determines the control member *displacement*, specified via port **S**, at which the **B-T** orifice is fully closed. Note that the control member *position* at which the valve is fully closed is always at zero. Set all opening offsets to positive values to model an underlapped valve or to negative values to model an overlapped valve.

Between P and B – Control member offset from the centered position relative to the P-A orifice

0 m (default) | positive scalar in units of length

Distance by which to offset the valve control member from its centered (zero) position relative to the **P-B** orifice. This parameter determines the control member *displacement*, specified via port **S**, at which the **P-B** orifice is fully closed. Note that the control member *position* at which the valve is fully closed is always at zero. Set all opening offsets to positive values to model an underlapped valve or to negative values to model an overlapped valve.

Between A and T – Control member offset from the centered position relative to the A-T orifice

0 m (default) | positive scalar in units of length

Distance by which to offset the valve control member from its centered (zero) position relative to the **A-T** orifice. This parameter determines the control member *displacement*, specified via port **S**, at which the **A-T** orifice is fully closed. Note that the control member *position* at which the valve is fully closed is always at zero. Set all opening offsets to positive values to model an underlapped valve or to negative values to model an overlapped valve.

Extended Capabilities

C/C++ Code Generation

Generate C and C++ code using Simulink® Coder™.

See Also

2-Way Directional Valve (TL) | Variable Area Orifice (TL) | 3-Way Directional Valve (TL) | Check Valve (TL)

Introduced in R2016a

4-Way Ideal Valve

Hydraulic 4-way critically-centered valve

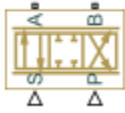

Library

Directional Valves

Description

The 4-Way Ideal Valve block represents a 4-way critically-centered valve, where initial openings of all four variable orifices are equal to zero. This significantly simplifies the model of a 4-way directional valve and makes it especially suitable for real-time and HIL (hardware-in-the-loop) simulation, where such assumption is applicable.

The flow rate is computed with the equation:

$$q = x C_D b \sqrt{\frac{1}{\rho} (p_S - \text{abs}(p_A - p_B)) \text{sign}(p_A - p_B)}$$

where

q	Flow rate
x	Valve displacement, $-x_{max} \leq x \leq x_{max}$
b	Orifice width, $b = A_{max} / x_{max}$
A_{max}	Maximum orifice area
x_{max}	Valve maximum opening
C_D	Flow discharge coefficient
ρ	Fluid density
p_S	Pressure supply
p_A, p_B	Pressures at the load ports A and B, respectively

Connections A and B are conserving hydraulic ports associated with the valve load ports. Connections P and S are the physical signal input ports that provide supply pressure and valve displacement values, respectively.

Basic Assumptions and Limitations

- The valve is of a critically-centered type, that is, all initial openings are equal to zero.
- The return pressure is assumed to be very low and can be treated as a zero pressure.

- All the orifices are assumed to have the same shape and size, that is, the valve is symmetrical.

Parameters

Valve passage maximum area

Specify the area of a fully opened valve. The parameter value must be greater than zero. The default value is $5e-5 \text{ m}^2$.

Valve maximum opening

Specify the maximum displacement of the control member. The parameter value must be greater than zero. The default value is 0.005 m .

Flow discharge coefficient

Semi-empirical parameter for valve capacity characterization. Its value depends on the geometrical properties of the valve, and usually is provided in textbooks or manufacturer data sheets. The default value is 0.7 .

Global Parameters

Parameter determined by the type of working fluid:

- **Fluid density**

Use the Hydraulic Fluid block or the Custom Hydraulic Fluid block to specify the fluid properties.

Ports

The block has the following ports:

A

Hydraulic conserving port associated with the actuator connection port.

B

Hydraulic conserving port associated with the actuator connection port.

P

Physical signal port that controls the supply pressure.

S

Physical signal port that controls spool displacement.

Examples

The “Closed-Loop Hydraulic Actuator Model for Real-Time Simulation” example is an example of using this valve, along with other blocks optimized for real-time and HIL simulation.

Extended Capabilities

C/C++ Code Generation

Generate C and C++ code using Simulink® Coder™.

See Also

4-Way Directional Valve

Topics

“Upgrading Simscape Fluids Models Containing Hydraulics (Isothermal) Blocks”

Introduced in R2010a

6-Way Directional Valve A

Configuration A of hydraulic continuous 6-way directional valve



Library

Directional Valves

Description

The 6-Way Directional Valve A block simulates a configuration of hydraulic continuous 6-way directional valve with pump port P, two return ports T and T1, and three actuator ports A, B, and C. Use the valve for applications with two actuators, each being controlled by a valve of this type. When both valves are in neutral position, the pump is unloaded. If any of the valves is shifted from neutral, the diverting line is cut off and the respective actuator is fed at fuel pump pressure. For more details, see the “Front-Loader Actuation System” example, which uses a similar system of two valves.

The 6-Way Directional Valve A block has six hydraulic connections, corresponding to the valve hydraulic ports (A, B, C, P, T, and T1), and one physical signal port connection (S), which controls the spool position. The block is built of six Variable Orifice blocks, connected as shown in the following diagram.

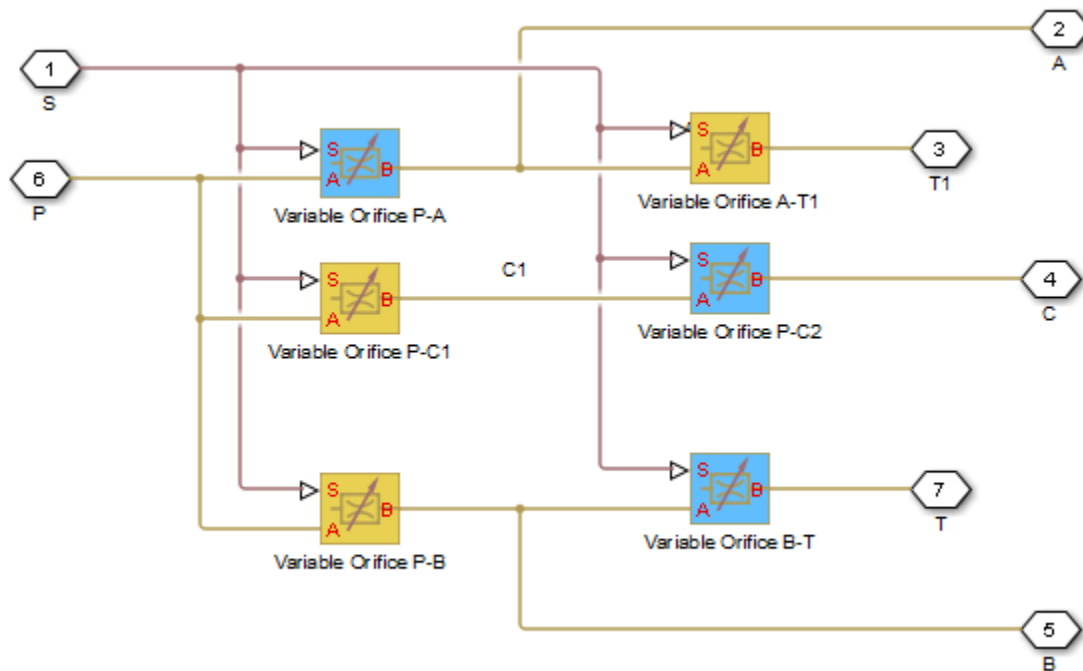

All blocks are controlled by the same position signal, provided through the physical signal port S, but the **Orifice orientation** parameter in the block instances is set in such a way that positive signal at port S opens the orifices colored blue in the block diagram (orifices P-A, B-T, and P-C2) and closes the orifices colored yellow (orifices A-T1, P-B, and P-C1). As a result, the openings of the orifices are computed as follows:

$$h_{PA} = h_{PA0} + x$$

$$h_{PB} = h_{PB0} - x$$

$$h_{AT1} = h_{AT10} - x$$

$$h_{BT} = h_{BT0} + x$$

$$h_{PC1} = h_{PC10} - x$$

$$h_{PC2} = h_{PC20} + x$$

where

h_{PA}	Orifice opening for the Variable Orifice P-A block
h_{PB}	Orifice opening for the Variable Orifice P-B block
h_{AT1}	Orifice opening for the Variable Orifice A-T1 block
h_{BT}	Orifice opening for the Variable Orifice B-T block
h_{PC1}	Orifice opening for the Variable Orifice P-C1 block
h_{PC2}	Orifice opening for the Variable Orifice P-C2 block
h_{PA0}	Initial opening for the Variable Orifice P-A block
h_{PB0}	Initial opening for the Variable Orifice P-B block
h_{AT10}	Initial opening for the Variable Orifice A-T1 block
h_{BT0}	Initial opening for the Variable Orifice B-T block
h_{PC10}	Initial opening for the Variable Orifice P-C1 block
h_{PC20}	Initial opening for the Variable Orifice P-C2 block
x	Control member displacement from initial position

For information on the block parameterization options, basic parameter descriptions, assumptions and limitations, global and restricted parameters, see the 4-Way Directional Valve block reference page.

Parameters

- “Basic Parameters Tab” on page 1-306
- “Valve Opening Offsets Tab” on page 1-309

Basic Parameters Tab

Model parameterization

Select one of the following methods for specifying the valve:

- **By maximum area and opening** — Provide values for the maximum valve passage area and the maximum valve opening. The passage area is linearly dependent on the control member displacement, that is, the valve is closed at the initial position of the control member (zero displacement), and the maximum opening takes place at the maximum displacement. This is the default method.
- **By area vs. opening table** — Provide tabulated data of valve openings and corresponding valve passage areas. The passage area is determined by one-dimensional table lookup. You have a choice of two interpolation methods and two extrapolation methods.
- **By pressure-flow characteristic** — Provide tabulated data of valve openings, pressure differentials, and corresponding flow rates. The flow rate is determined by two-dimensional table lookup. You have a choice of two interpolation methods and two extrapolation methods.

Valve passage maximum area

Specify the area of a fully opened valve. The parameter value must be greater than zero. The default value is $5e-5 \text{ m}^2$. This parameter is used if **Model parameterization** is set to **By maximum area and opening**.

Valve maximum opening

Specify the maximum displacement of the control member. The parameter value must be greater than zero. The default value is $5e-3 \text{ m}$. This parameter is used if **Model parameterization** is set to **By maximum area and opening**.

Valve opening vector, s

Specify the vector of input values for valve openings as a one-dimensional array. The input values vector must be strictly increasing. The values can be nonuniformly spaced. The minimum number of values depends on the interpolation method: you must provide at least two values for linear interpolation, at least three values for smooth interpolation. The default values, in meters, are $[-0.002 \ 0 \ 0.002 \ 0.005 \ 0.015]$. If **Model parameterization** is set to **By area vs. opening table**, the **Tabulated valve openings** values will be used together with **Tabulated valve passage area** values for one-dimensional table lookup. If **Model parameterization** is set to **By pressure-flow characteristic**, the **Tabulated valve openings** values will be used together with **Tabulated pressure differentials** and **Tabulated flow rates** for two-dimensional table lookup.

Valve passage area vector

Specify the vector of output values for valve passage area as a one-dimensional array. The valve passage area vector must be of the same size as the valve openings vector. All the values must be positive. The default values, in m^2 , are $[1e-09 \ 2.0352e-07 \ 4.0736e-05 \ 0.00011438 \ 0.00034356]$. This parameter is used if **Model parameterization** is set to **By area vs. opening table**.

Pressure differential vector, dp

Specify the vector of input values for pressure differentials as a one-dimensional array. The vector must be strictly increasing. The values can be nonuniformly spaced. The minimum number of values depends on the interpolation method: you must provide at least two values for linear interpolation, at least three values for smooth interpolation. The default values, in Pa, are $[-1e+07 \ -5e+06 \ -2e+06 \ 2e+06 \ 5e+06 \ 1e+07]$. This parameter is used if **Model parameterization** is set to **By pressure-flow characteristic**.

Volumetric flow rate table, q(s,dp)

Specify the flow rates as an m -by- n matrix, where m is the number of valve openings and n is the number of pressure differentials. Each value in the matrix specifies flow rate taking place at a specific combination of valve opening and pressure differential. The matrix size must match the dimensions defined by the input vectors. The default values, in m^3/s , are:

```
[-1e-07 -7.0711e-08 -4.4721e-08 4.4721e-08 7.0711e-08 1e-07;
-2.0352e-05 -1.4391e-05 -9.1017e-06 9.1017e-06 1.4391e-05 2.0352e-05;
-0.0040736 -0.0028805 -0.0018218 0.0018218 0.0028805 0.0040736;
-0.011438 -0.0080879 -0.0051152 0.0051152 0.0080879 0.011438;
-0.034356 -0.024293 -0.015364 0.015364 0.024293 0.034356;]
```

This parameter is used if **Model parameterization** is set to **By pressure-flow characteristic**.

Interpolation method

Select one of the following interpolation methods for approximating the output value when the input value is between two consecutive grid points:

- **Linear** — Select this option to get the best performance.
- **Smooth** — Select this option to produce a continuous curve (**By area vs. opening table**) or surface (**By pressure-flow characteristic**) with continuous first-order derivatives.

For more information on interpolation algorithms, see the PS Lookup Table (1D) and PS Lookup Table (2D) block reference pages.

Extrapolation method

Select one of the following extrapolation methods for determining the output value when the input value is outside the range specified in the argument list:

- **Linear** — Select this option to produce a curve or surface with continuous first-order derivatives in the extrapolation region and at the boundary with the interpolation region.
- **Nearest** — Select this option to produce an extrapolation that does not go above the highest point in the data or below the lowest point in the data.

For more information on extrapolation algorithms, see the PS Lookup Table (1D) and PS Lookup Table (2D) block reference pages.

Flow discharge coefficient

Semi-empirical parameter for valve capacity characterization. Its value depends on the geometrical properties of the valve, and usually is provided in textbooks or manufacturer data sheets. The default value is 0.7.

Laminar transition specification

Select how the block transitions between the laminar and turbulent regimes:

- **Pressure ratio** — The transition from laminar to turbulent regime is smooth and depends on the value of the **Laminar flow pressure ratio** parameter. This method provides better simulation robustness.
- **Reynolds number** — The transition from laminar to turbulent regime is assumed to take place when the Reynolds number reaches the value specified by the **Critical Reynolds number** parameter.

Laminar flow pressure ratio

Pressure ratio at which the flow transitions between laminar and turbulent regimes. The default value is 0.999. This parameter is visible only if the **Laminar transition specification** parameter is set to **Pressure ratio**.

Critical Reynolds number

The maximum Reynolds number for laminar flow. The value of the parameter depends on the orifice geometrical profile. You can find recommendations on the parameter value in hydraulics textbooks. The default value is 12, which corresponds to a round orifice in thin material with

sharp edges. This parameter is visible only if the **Laminar transition specification** parameter is set to Reynolds number.

Leakage area

The total area of possible leaks in the completely closed valve. The main purpose of the parameter is to maintain numerical integrity of the circuit by preventing a portion of the system from getting isolated after the valve is completely closed. The parameter value must be greater than 0. The default value is $1e-12 \text{ m}^2$.

Valve Opening Offsets Tab

Between ports P and A

Orifice opening of the **P-A** flow path at zero spool displacement. Specify a positive offset to model an underlapped valve or a negative offset to model an overlapped valve. The default value of θ corresponds to a zero-lapped valve. The default value is $-2.5e-3 \text{ m}$.

Between ports P and B

Orifice opening of the **P-B** flow path at zero spool displacement. Specify a positive offset to model an underlapped valve or a negative offset to model an overlapped valve. The default value of θ corresponds to a zero-lapped valve. The default value is $-2.5e-3 \text{ m}$.

Between ports A and T1

Orifice opening of the **A-T1** flow path at zero spool displacement. Specify a positive offset to model an underlapped valve or a negative offset to model an overlapped valve. The default value of θ corresponds to a zero-lapped valve. The default value is $-2.5e-3 \text{ m}$.

Between ports B and T

Orifice opening of the **B-T** flow path at zero spool displacement. Specify a positive offset to model an underlapped valve or a negative offset to model an overlapped valve. The default value of θ corresponds to a zero-lapped valve. The default value is $-2.5e-3 \text{ m}$.

Between ports P and C1

Orifice opening of the **P-C1** flow path at zero spool displacement. Specify a positive offset to model an underlapped valve or a negative offset to model an overlapped valve. The default value of θ corresponds to a zero-lapped valve. The default value is $2.5e-3 \text{ m}$.

Between ports P and C2

Orifice opening of the **P-C2** flow path at zero spool displacement. Specify a positive offset to model an underlapped valve or a negative offset to model an overlapped valve. The default value of θ corresponds to a zero-lapped valve. The default value is $2.5e-3 \text{ m}$.

Ports

The block has the following ports:

P

Hydraulic conserving port associated with the pressure supply line inlet.

T

Hydraulic conserving port associated with the first return line connection.

T1

Hydraulic conserving port associated with the second return line connection.

- A Hydraulic conserving port associated with the actuator connection port.
- B Hydraulic conserving port associated with the actuator connection port.
- C Hydraulic conserving port associated with the actuator connection port.
- S Physical signal port to control spool displacement.

Extended Capabilities

C/C++ Code Generation

Generate C and C++ code using Simulink® Coder™.

See Also

4-Way Directional Valve | 4-Way Directional Valve A | 4-Way Directional Valve B | 4-Way Directional Valve C | 4-Way Directional Valve D | 4-Way Directional Valve E | 4-Way Directional Valve F | 4-Way Directional Valve G | 4-Way Directional Valve H | 4-Way Directional Valve K

Topics

“Upgrading Simscape Fluids Models Containing Hydraulics (Isothermal) Blocks”

Introduced in R2009b

Air Muscle Actuator (G)

Linear actuator with force characteristics of biological muscle

Library: Simscape / Fluids / Gas / Actuators



Description

The Air Muscle Actuator (G) block models a linear actuator popular in robotics for its characteristics reminiscent of biological muscle. The actuator comprises an expandable bladder in a braided shell. When the bladder is pressurized, the pair widens and simultaneously shortens, producing at their end caps a contractile force. The bladder is pressurized at Gas port **A**; the force is exerted at Mechanical Translational ports **R** and **C**.



Air Muscle in Relaxed State

Air muscles are often installed in pairs—one muscle serving as agonist, the other as antagonist. Pairs of this sort are common in the human body, where the biceps (in the arm) accompanies the triceps, and the quadriceps (in the leg) accompanies the hamstrings. The muscles attach at one end to a joint, but at an offset so as to produce a torque. When the net torque is other than zero, and if loading conditions allow, the joint rotates.

Actuator Force

The mass and energy balances of the actuator are as described for the Translational Mechanical Converter (G) block. The actuator force, however, is based on the standard Chou-Hannaford equation (with two corrections made for the simplifying assumptions of the original model). In its original form, the Chou-Hannaford equation gives:

$$F_{C-H} = \frac{\pi D_M^2 P}{4} \left[3 \left(\frac{L}{l} \right)^2 - 1 \right],$$

where:

- F is the contractile force exerted by the actuator on its ends. The subscript C-H denotes the theoretical value of the original Chou-Hannaford model.
- D is the diameter of the bladder and shell assembly. The subscript M denotes its maximum theoretical value—that in which the braids of the shell are at right angles to its longitudinal axis.
- P is the gauge pressure in the bladder (measured against the environment external to the actuator).
- L is the length of the actuator (the distance between the mechanical ports **R** and **C**).

- l is the natural length of a braid (before it is stretched in a pressurized bladder). The braids, as they are wound about the longitudinal axis of the actuator, are always longer than the actuator itself).

The maximum theoretical diameter of the actuator is defined as:

$$D_M = \frac{l}{n\pi},$$

where n is the number of turns that a braid makes about the longitudinal axis of the actuator.

Implicit in the Chou-Hannaford equation are the assumptions of infinitely thin bladder and shell and of inelastic braids incapable of stretching. Both assumptions can lower the accuracy of the model and are corrected for in this block. The correction for the stretching in a braid replaces the constant length l with the variable length l^* :

$$l^* = \frac{Cl + \sqrt{(Cl)^2 + 12L^2(C + 1)}}{2(C + 1)} + \frac{2nPD^2}{Ed},$$

where l is the natural length of a braid used in the original Chou-Hannaford equation and:

- C is a correction term for braid stretching.
- E is Young's modulus of elasticity for the material of the braids.
- d is the diameter of a strand in a braid (each braid being a bundle of tightly intertwined strands).

The correction term for braid stretching is defined as:

$$C = \frac{n^2\pi^2Ed^2N}{PlL},$$

where N is the total number strands in the braided shell. The correction for the thickness of the bladder and shell adds to the total actuator force the factor:

$$F_T = \pi P \left[t \left(2D - \frac{D_M^2}{D} \right) - t^2 \right]$$

where t is the aggregate thickness of the bladder and shell and the subscript T denotes the correction for thickness. The total actuator force is:

$$F = F_{H-F} + F_T,$$

where the strand length used in the calculation of the Chou-Hannaford term is the variable l^* . This force is counteracted at the limits of extension and contraction by translational hard stops. These are modeled as described for the Translational Hard Stop block.

Modeling Assumptions

- There is no flow resistance between the gas entrance (port **A**) and the interior of the actuator.
- There is no thermal resistance between the actuator wall (port **H**) and the gas that it encloses.
- The actuator is hermetic and does not leak.
- The effects of friction and inertia are ignored.
- The bladder and shell are perfectly cylindrical no matter their inflation level.

- The longitudinal elasticity of the bladder is ignored.

Ports

Conserving

A — Actuator inlet

gas

Gas opening for pressurizing the actuator. Connect this port to the pressure source for the actuator. The pressure at this port controls the force generated by the actuator.

R — Actuator end cap

mechanical translational

One of two end caps at which the actuator force is applied. Connect this port to the fixture on which the actuator is to be mounted or to the load that the actuator is to move.

C — Actuator end cap

mechanical translational

One of two end caps at which the actuator force is applied. Connect this port to the fixture on which the actuator is to be mounted or to the load that the actuator is to move.

H — Actuator wall

thermal

Thermal boundary condition between the gas volume of the actuator and its surroundings. Connect this port to blocks in the Thermal domain to capture heat transfer by conduction, convection, or radiation, for example, or to insulate the actuator from the environment.

Parameters

Initial actuator length — Distance between end caps when unloaded and unpressurized

0.575 m (default) | positive scalar in units of length

Distance between the end caps of the actuator in the relaxed state, when it is both unloaded and unpressurized. Inflating the actuator during simulation causes it to widen and simultaneously to shorten. The actuator is shorter than its braids, which is to say that its initial length should be less than the **Unstretched braid length** parameter.

Unstretched braid length — Length of straightened braid when unloaded

0.65 m (default) | positive scalar in units of length

Length of a braid as measured with its turns straightened and any loads removed. If the braids are elastic, their (common) length will vary with during simulation pressure and load. As the braids are wound about the longitudinal axis of the actuator, their length is always greater than the **Initial actuator length** parameter.

Number of turns per braid — Number of turns in a braid about the actuator length axis

4.7 (default) | positive unitless scalar

Number of turns that a braid makes about the longitudinal axis of the actuator from one end cap to the second.

Braid stretching — Choice of whether to model the stretching of a braid

Inelastic braids (default) | Elastic braids

Choice of whether to model the stretching of a braid. The default option, `Inelastic braids`, treats the braids as flexible but inextensible. This is the assumption implicit in the original Chou-Hannaford equation. The length of a braid is then constant during simulation.

The alternative option, `Elastic braids`, allows the braids to extend with actuator load and pressure. The length of the braid is then treated as variable during simulation. This change adds a correction to the Chou-Hannaford equation for force.

Thickness of braided shell and bladder — Combined thickness of shell and bladder

0.075 m (default) | positive scalar in units of length

Sum of the thicknesses of the braided shell and of the bladder inside it. A finite thickness adds to the Chou-Hannaford equation for force a correction term. (In the original Chou-Hannaford equation, the shell and bladder are assumed to be infinitely thin.)

Cross-sectional area at port A — Area normal to flow at the gas port

0.01 m (default) | positive scalar in units of length

Area normal to flow at the gas port of the actuator.

Total number of braids — Number of braids in the braided shell

80 (default) | positive unitless scalar

Number of braids in the shell surrounding the bladder. As the braids are each a bundle of intertwined strands, the number of braids is not generally the same as the number of strands.

Dependencies

This parameter is active when the **Braid stretching** option is set to `Elastic Braids`.

Number of strands per braid — Number of individual strands in a braid

3 (default) | positive unitless scalar

Number of strands in a braid. The product of this number and the **Total number of braids** parameter gives the total number of strands in the shell.

Dependencies

This parameter is active when the **Braid stretching** option is set to `Elastic Braids`.

Strand diameter — Diameter of a strand

0.25 m (default) | positive scalar in units of length

Average diameter of a strand throughout its length.

Dependencies

This parameter is active when the **Braid stretching** option is set to `Elastic Braids`.

Young's modulus of strands — Degree to which the strands extend under pressure

3e9 GPA (default)

Young's modulus of elasticity for the material of the strands. This parameter determines the degree to which the strands extend under pressure.

Dependencies

This parameter is active when the **Braid stretching** option is set to `Elastic Braids`.

Environment pressure specification – Pressure condition outside of the actuator

`Atmospheric pressure` (default) | `Specified pressure`

Pressure condition in the immediate surroundings of the actuator. The gauge pressure in the actuator is obtained relative to this pressure. Select `Atmospheric pressure` to use the atmospheric value specified in the Two-Phase Fluid Properties (2P) block or `Specified pressure` to use a different pressure.

Environment pressure – Absolute pressure outside of the actuator

`0.101325` (default) | scalar in units of pressure

Absolute pressure in the immediate surroundings of the actuator. The actuator contracts when the gauge pressure at port **A** (measured against this value) is greater than zero.

Dependencies

This parameter is active when the **Environment pressure specification** option is set to `Specified pressure`.

Contact stiffness of braids at full muscle contraction or extension – Stiffness coefficient for contact force at actuator motion limits

`1e6` N/m (default)

Stiffness coefficient for the contact force at the limits of the actuator's range of motion. The contact force keeps the actuator from extending or contracting beyond its physical limits. The contact force is modeled using a spring-damper system. The spring element adds a restorative force that pulls the end caps back once they reach either limit of motion.

For more information on the force model, see the Translational Hard Stop block.

Contact damping of braids at full muscle contraction or extension – Damping coefficient for contact force at actuator motion limits

`1e4` N/(m/s) (default)

Damping coefficient for the contact force at the limits of the actuator's range of motion. The contact force keeps the actuator from extending or contracting beyond its physical limits. This force is modeled using a spring-damper system. The damper adds a viscous force to the end caps once they reach a limit of motion, causing them to slow to a stop.

For more information on the force model, see the Translational Hard Stop.

Extended Capabilities

C/C++ Code Generation

Generate C and C++ code using Simulink® Coder™.

See Also

Fan (G) | Translational Mechanical Converter (G) | Translational Hard Stop

Introduced in R2018b

Angle Sensor

Ideal angle sensor with measuring range from 0 to 360 degrees



Library

Pumps and Motors

Description

The Angle Sensor block represents an ideal angle sensor with measuring range from 0 to 360 degrees. To measure an angular displacement, the sensor must be connected to a mechanical rotational port. No load is imposed on the measured object. The sensor output is kept within the range from 0 to 2π radians (360 degrees) regardless of the number of revolutions performed by the object and the direction of rotation. The sensor is ideal because it does not account for inertia, friction, and so on.

The difference between the Angle Sensor block and the Ideal Rotational Motion Sensor block, available in the Simscape Foundation library, is demonstrated in the following figure.

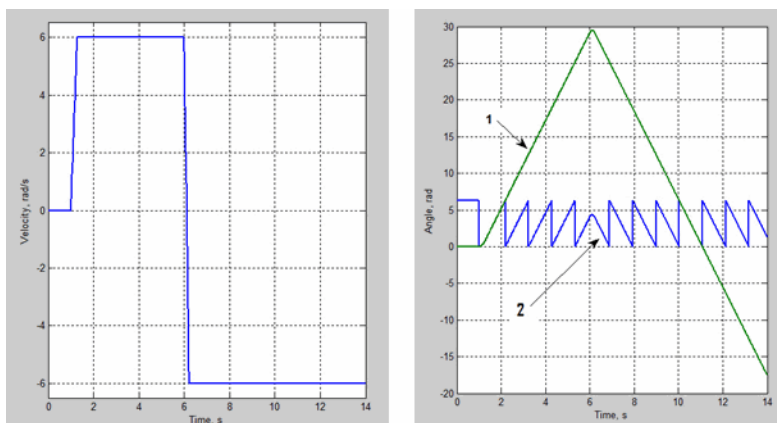

In this example, the object is moving at 6 rad/s in the positive direction for the first 5 seconds, and then switches to the negative direction at the same speed. The Ideal Rotational Motion Sensor block output (line 1) shows that the object turned forward by 30 rad and then turned back in the negative direction, continuing until -20 rad. The reading of the Angle Sensor block (line 2) stays in the range from 0 to 2π rad.

Availability of the Angle Sensor block considerably simplifies development of models with complex relationship between model parameters and rotation angle, such as pumps and motors.

Basic Assumptions and Limitations

- The sensor is assumed to be ideal. No load is imposed on the object.
- No inertial effects are considered.

Parameters

Phase angle

This parameter lets you account for angular shift between the object and the sensor input. The default value is 0.

Ports

The block has the following ports:

W

Mechanical rotational conserving port associated with the probe of the sensor.

A

Physical signal port that outputs the angular displacement of the object.

Examples

The “Hydraulic Axial-Piston Pump with Load-Sensing and Pressure-Limiting Control” example models a test rig designed to investigate interaction between an axial-piston pump and a typical control unit, simultaneously performing the load-sensing and pressure-limiting functions. To assure required accuracy, the model of the pump must account for such features as interaction between pistons, swash plate, and porting plate, which makes it necessary to build a detailed pump model.

The Angle Sensor block is used in each of the piston model subsystems (`Piston_1`, ..., `Piston_5`), where it provides the angular position of the respective piston as input to the Porting Plate Variable Orifice blocks.

Extended Capabilities

C/C++ Code Generation

Generate C and C++ code using Simulink® Coder™.

See Also

Ideal Rotational Motion Sensor

Topics

“Upgrading Simscape Fluids Models Containing Hydraulics (Isothermal) Blocks”

Introduced in R2011a

Annular Leakage (IL)

Models annular leakage between a circular tube and a round insert in an isothermal flow

Library: Simscape / Fluids / Isothermal Liquid / Valves & Orifices / Orifices

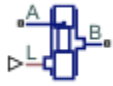

Description

The Annular Leakage (IL) block models annular leakage between a circular tube and a round insert in an isothermal liquid network. The insert can be located off-center from the tube and can have varying lengthwise overlap with the tube.

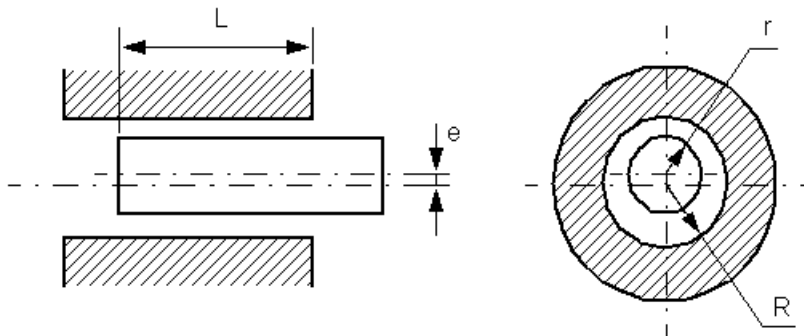

Ports **A** and **B** correspond with the orifice inlet and outlet. The input ports **L** and **E** are optional physical signal ports that model variable overlap length (L) and variable eccentricity (E).

The Mass Flow Rate Equation

The leakage mass flow rate is calculated from the pressure-flow rate equation

$$\dot{m} = \frac{\pi(R-r)^3(R+r)}{12\nu} \frac{(p_A - p_B)}{l} \left[1 + 3\varepsilon_{sat}^2 \frac{R}{(R+r)} + \frac{3}{8} \varepsilon^4 \frac{(R-r)}{(R+r)} \right],$$

where:

- R is the annulus outer radius.
- r is the annulus inner radius.
- p_A is the pressure at port **A**.
- p_B is the pressure at port **B**.
- ν is the fluid kinematic viscosity.
- l is the overlap length.

- ε is the eccentricity ratio, $\varepsilon = \frac{e}{R-r}$, where e is the eccentricity, which can be defined as a physical signal or constant value.
- ε_{sat} is the saturated eccentricity ratio, which is ε for constant orifices, or the physical signal connected to port **L** for variable orifices. The eccentricity ratio is always between 0 and 1.

When modeling a variable overlap length, the user-defined minimum overlap length is used if the physical signal falls below the value of the **Minimum overlap length** parameter.

Assumptions and Limitations

The pressure-flow equation is valid only for fully-developed, laminar flows. The flow Reynolds number can be determined using $Re = \frac{\dot{m}D_h}{\mu\pi(R^2 - r^2)}$ or by checking the simulation log in the Results Explorer or the Simulation Data Inspector. For more information, see “Data Logging”.

Ports

Conserving

A – Liquid port

isothermal liquid

Entry or exit port of the liquid to or from the orifice.

B – Liquid port

isothermal liquid

Entry or exit port of the liquid to or from the orifice.

Input

L – Variable overlap length

physical signal

Optional physical signal port that provides the variable overlap length between the sleeve and annular insert.

Dependencies

To expose this port, set **Overlap length specification** to Variable.

E – Variable eccentricity

physical signal

Optional physical signal port that provides variable eccentricity of the annular insert to the sleeve.

Dependencies

To expose this port, set **Eccentricity specification** to Variable.

Parameters

Overlap length specification — Type of insert-sleeve overlap

Constant (default) | Variable

Whether the length-wise sleeve-insert overlap is constant or variable.

Overlap length — Overlap between tube and insert

$1e-3$ m (default) | positive scalar

Length-wise overlap between the insert and tube.

Dependencies

To enable this parameter, set **Overlap length specification** to Constant.

Minimum overlap length — Minimum overlap between tube and insert

$1e-6$ m (default) | positive scalar

Lower limit to the length-wise overlap between the insert and tube. Any length shorter than this value will be set to the specified minimum.

Dependencies

To enable this parameter, set **Overlap length specification** to Variable.

Eccentricity specification — Eccentricity variability

Constant (default) | Variable

Whether the orifice eccentricity changes or remains at a set value.

Eccentricity — Center of insert offset with respect to sleeve center

0 m (default) | positive scalar

The distance between the center of the orifice and the center of the insert.

Dependencies

To enable this parameter, set **Eccentricity specification** to Constant.

Inner radius — Radius of insert

$9.8e-3$ m (default) | positive scalar

Insert radius r .

Outer radius — Radius of tube

$1e-2$ m (default) | positive scalar

Tube radius R , measured from the tube center to the inner wall.

See Also

Orifice (IL) | Spool Orifice (IL) | Variable Overlapping Orifice (IL)

Introduced in R2020a

Annular Orifice

Hydraulic variable orifice created by circular tube and round insert

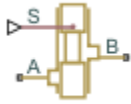

Library

Orifices

Description

The Annular Orifice block annular leakage in a fully-developed laminar flow created by a circular tube and a round insert in an isothermal liquid network. The insert can be located off-center from the tube by an eccentricity value.

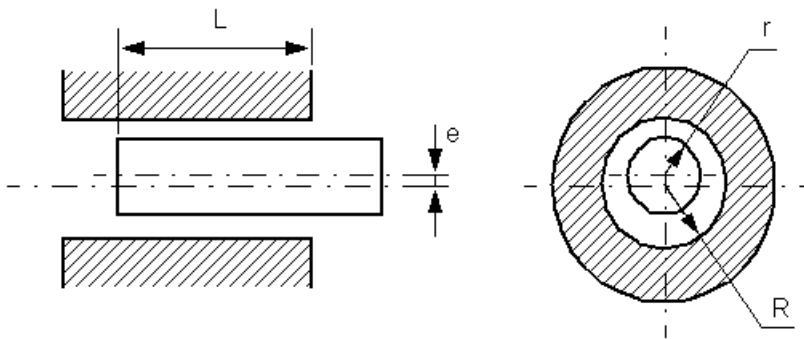

The flow rate is computed using the Hagen-Poiseuille equation (see [1] on page 1-324):

$$q = \frac{\pi R(R-r)^3}{6\nu\rho L} \cdot \left(1 + \frac{3}{2}\varepsilon^2\right) \cdot p$$

$$\varepsilon = \frac{e}{R-r}$$

where

q	Flow rate
p	Pressure differential
R	Orifice radius
r	Insert radius

L	Overlap length
ε	Eccentricity ratio
e	Eccentricity
ρ	Fluid density
ν	Fluid kinematic viscosity

Use this block to simulate leakage path in plungers, valves, and cylinders.

The block positive direction is from port A to port B. This means that the flow rate is positive if it flows from A to B and the pressure differential is determined as $\Delta p = p_A - p_B$. Positive signal at the physical signal port S increases or decreases the overlap, depending on the value of the parameter **Orifice orientation**.

Basic Assumptions and Limitations

Fluid inertia is not taken into account.

Parameters

Orifice radius

The radius of the tube. The default value is 0.01 m.

Insert radius

The radius of the insert. The default value is 0.0098 m.

Eccentricity

The distance between the central axes of the insert and the tube. The parameter can be a positive value, smaller than the difference between the radius of the tube and the radius of the insert, or equal to zero for coaxial configuration. The default value is 0.

Initial length

Initial overlap between the tube and the insert. The parameter must be positive. The value of initial length does not depend on the orifice orientation. The default value is 0.003 m.

Orifice orientation

The parameter is introduced to specify the effect of the control signal on the orifice overlap. The parameter can be set to one of two options: **Positive signal increases overlap** or **Negative signal increases overlap**. The default value is **Positive signal increases overlap**.

Restricted Parameters

When your model is in Restricted editing mode, you cannot modify the following parameter:

- **Orifice orientation**

All other block parameters are available for modification.

Global Parameters

Parameters determined by the type of working fluid:

- **Fluid density**
- **Fluid kinematic viscosity**

Use the Hydraulic Fluid block or the Custom Hydraulic Fluid block to specify the fluid properties.

Ports

The block has the following ports:

A

Hydraulic conserving port associated with the orifice inlet.

B

Hydraulic conserving port associated with the orifice outlet.

S

Physical signal port that controls the insert displacement.

References

[1] Noah D. Manring, *Hydraulic Control Systems*, John Wiley & Sons, 2005

See Also

Constant Area Hydraulic Orifice | Fixed Orifice | Orifice with Variable Area Round Holes | Orifice with Variable Area Slot | Variable Area Hydraulic Orifice | Variable Orifice

Topics

“Upgrading Simscape Fluids Models Containing Hydraulics (Isothermal) Blocks”

Introduced in R2006b

Area Change (IL)

Area expansion or contraction along a pipe in an isothermal liquid network

Library: Simscape / Fluids / Isothermal Liquid / Pipes & Fittings



Description

The Area Change (IL) block models a sudden or a gradual area change along a pipe with fixed areas and variable flow direction. When the fluid moves from port **A** to port **B**, it experiences an area contraction. When the fluid flows from port **B** to port **A**, it experiences an area expansion. The inlet and outlet areas can be equal.

Both semi-empirical and tabular formulations are available for correlating flows to losses.

Semi-Empirical Formulation

In the semi-empirical, analytical formulation, losses in pressure and velocity are characterized by a *Hydraulic loss coefficient*, K , in terms of a user-defined **Contraction correction factor**, $C_{\text{contraction}}$, and **Expansion correction factor**, $C_{\text{expansion}}$, from Crane [1]. The coefficient that characterizes area change is calculated from both expansion and contraction loss factors and based on the flow rate through the block.

For gradual conical area contractions between 0 and 45 degrees, the contraction loss factor is:

$$K_{\text{contraction}} = 0.8C_{\text{contraction}}\sin\left(\frac{\theta}{2}\right)(1 - R),$$

where R is the port area ratio $\frac{A_{\text{smaller}}}{A_{\text{bigger}}}$. For gradual area contraction between 45 and 180 degrees:

$$K_{\text{contraction}} = \frac{C_{\text{contraction}}}{2}\sqrt{\sin\left(\frac{\theta}{2}\right)}(1 - R),$$

where θ is the **Cone angle**. A sudden area change has an angle of 180 degrees. In this case, the loss factor is calculated as $K_{\text{contraction}} = \frac{C}{2}(1 - R)$.

For gradual conical area expansions between 0 and 45 degrees, the expansion loss factor is:

$$K_{\text{expansion}} = 2.6C_{\text{expansion}}\sin\left(\frac{\theta}{2}\right)(1 - R)^2,$$

and for gradual area expansion between 45 and 180 degrees:

$$K_{\text{expansion}} = C_{\text{expansion}}(1 - R)^2.$$

The hydraulic loss coefficient for the pipe change segment is calculated from these values as:

$$K = K_{\text{expansion}} + \frac{K_{\text{contraction}} - K_{\text{expansion}}}{2}\left(\tanh\left(\frac{3\dot{m}_A}{\dot{m}_{th}}\right) + 1\right),$$

where:

- \dot{m}_A is the mass flow rate through port **A**. Mass is conserved through the segment: $\dot{m}_A + \dot{m}_B = 0$.
- \dot{m}_{th} is the threshold mass flow rate for flow reversal, which is based on the **Critical Reynolds number**, Re_c :

$$\dot{m}_{th} = \frac{Re_c A_R \nu \bar{\rho}}{D_h},$$

where:

- A_R is the smallest segment area (either the **Cross-sectional area at port A** or the **Cross-sectional area at port B**.)
- ν is the fluid kinematic viscosity.
- $\bar{\rho}$ is the average fluid density.
- D_h is the hydraulic diameter at A_R : $D_h = \sqrt{\frac{4A_R}{\pi}}$.

Tabulated Data Parameterization

The loss factor can also be parameterized with user-provided data interpolated from the Reynolds number at the smallest area, which in turn is a function of the **Critical Reynolds number**:

$$K = TLU(Re_c).$$

Linear interpolation is employed between data points, and nearest-neighbor extrapolation is employed beyond the table boundaries.

Pressure Differential

The pressure differential over the area change is

$$p_A - p_B = \frac{\dot{m}^2}{2\bar{\rho}A_R^2}(1 - R^2) + \Delta p_{loss},$$

where the pressure loss is:

$$\Delta p_{loss} = \frac{K}{2\bar{\rho}A_R^2} \dot{m}_A \sqrt{\dot{m}_A^2 + \dot{m}_{th}^2}.$$

Ports

Conserving

A — Liquid port

isothermal liquid

Liquid entry port.

B — Liquid port

isothermal liquid

Liquid exit port.

Parameters

Cone angle — Gradual area change angle

30 (default) | positive scalar

Angle of expansion for a gradual area change parameterized as a cone.

Dependencies

To enable this parameter, set **Local loss parameterization** to Semi-empirical correlation - gradual area change.

Local loss parameterization — Model of hydraulic losses

Semi-empirical correlation - sudden area change (default) | Semi-empirical correlation - gradual area change | Tabulated data - loss coefficient vs. Reynolds number

Model of hydraulic losses due to area change. You can choose from two analytical, semi-empirical formulations or you can provide your own data by selecting Tabulated data - loss coefficient vs. Reynolds number.

Cross-sectional area at port A — Area at port A

0.02 m² (default) | positive scalar

Area at the section entrance, port **A**.

Cross-sectional area at port B — area at port B

0.01 m² (default) | positive scalar

Area at the section exit, port **B**.

Reynolds number vector — Vector of Reynolds number values for tabular parameterization

[10, 20, 30, 40, 50, 100, 200, 500, 1000, 2000] (default) | 1-by-*n* vector

Vector of Reynolds number values for the tabular parameterization of the area change. The elements must correspond one-to-one with the elements of the **Contraction loss coefficient vector** and the **Expansion loss coefficient vector** parameters. The vector values are listed in ascending order.

Dependencies

To enable this parameter, set **Local loss parameterization** to Tabulated data - loss coefficient vs. Reynolds number.

Contraction loss coefficient vector — Vector of loss coefficients for an area contraction

[5, 2.7, 1.8, 1.46, 1.3, .9, .65, .42, .3, .2] (default) | 1-by-*n* vector

Vector of loss coefficients for an area contraction corresponding to the **Reynolds number vector** parameter, where *n* is the length of the **Reynolds number vector**. The elements are listed in descending order and must be greater than 0.

Dependencies

To enable this parameter, set **Local loss parameterization** to Tabulated data - loss coefficient vs. Reynolds number.

Expansion loss coefficient vector – Vector of loss coefficients for an area expansion
[3.1, 2.3, 1.65, 1.35, 1.15, .9, .75, .65, .9, .65] (default) | 1-by- n vector

Vector of loss coefficients for an area expansion corresponding to the **Reynolds number vector** parameter, where n is the length of the **Reynolds number vector**. The elements are listed in descending order and must be greater than 0.

Dependencies

To enable this parameter, set **Local loss parameterization** to Tabulated data - loss coefficient vs. Reynolds number.

Expansion correction factor – Coefficient in semi-empirical loss factor equation
1 (default) | positive scalar

Coefficient used in the semi-empirical calculation of the area expansion loss factor.

Dependencies

To enable this parameter, set **Local loss parameterization** to either:

- Semi-empirical correlation - sudden area change
- Semi-empirical correlation - gradual area change

Contraction correction factor – Coefficient in semi-empirical loss factor equation
1 (default) | positive scalar

Coefficient used in the semi-empirical calculation of the area contraction loss factor.

Dependencies

To enable this parameter, set **Local loss parameterization** to either:

- Semi-empirical correlation - sudden area change
- Semi-empirical correlation - gradual area change

Critical Reynolds number – Upper Reynolds number limit for laminar flow
150 (default) | positive scalar

Upper Reynolds number limit for laminar flow through the orifice.

References

[1] *Flow of Fluids Through Valves, Fittings, and Pipe*, Crane Valves North America, Technical Paper No. 410M

[2] Idelchik, I.E., *Handbook of Hydraulic Resistance*, CRC Begell House, 1994

See Also

Pipe Bend (IL) | Elbow (IL) | Local Resistance (IL) | T-Junction (IL)

Introduced in R2020a

Ball Valve

Valve with a sliding ball control mechanism

Library: Simscape / Fluids / Hydraulics (Isothermal) / Valves / Flow Control Valves



Description

The Ball Valve block models an orifice with a variable opening area controlled by a sliding ball mechanism. The opening area changes with the relative position of the ball—the *valve lift*. A displacement toward the orifice decreases flow while a displacement away increases flow. The interface between the orifice and the ball—the *valve seat*—can be **Sharp-edged**, shown left in the figure, or **Conical**, shown right.

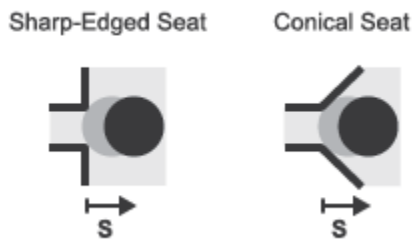

Ball Valve Seat Types

Opening Area

The valve lift is a function of the displacement signal specified through port **S**. The two can, but generally do not, have the same value. The valve lift differs from the displacement whenever the **Ball displacement offset** parameter is nonzero:

$$h(x) = x_0 + s,$$

where:

- h is the valve lift.
- x_0 is the ball displacement offset.
- s is the ball displacement (relative to the specified offset).

The valve is fully closed when the valve lift is equal to zero or less. It is fully open when the valve lift reaches or exceeds a (geometry-dependent) value sufficient to completely clear the orifice. A fully closed valve has an opening area equal to the specified **Leakage area** parameter while a fully open valve has the maximum possible opening area. Adjusting for internal leakage:

$$A_{Max} = \pi r_0^2 + A_{Leak},$$

where:

- A_{Max} is the maximum opening area.
- r_o is the orifice radius.
- A_{Leak} is the internal leakage area between the ports.

At intermediate values of the valve lift, the opening area depends on the valve seat geometry. If the **Valve seat specification** parameter is set to Sharp-Edged, the opening area as a function of valve lift is:

$$A(h) = \pi r_o \left(1 - \left[\frac{r_B}{d_{OB}} \right]^2 \right) d_{OB}(h),$$

where:

- A is the opening area at a given valve lift value.
- r_B is the ball radius.
- $d_{OB}(h)$ is the distance from the center of the ball (point **O** in the figure) to the edge of the orifice (point **B**). This distance is a function of the valve lift (h).

If the **Valve seat specification** parameter is set to Conical, the opening area becomes:

$$A(h) = \pi h \cos(\theta) \sin(\theta) \cdot (2r_B + h \sin(\theta)),$$

where θ is the angle between the conical surface and the orifice centerline. The geometrical parameters and variables used in the equations are shown in the figure.

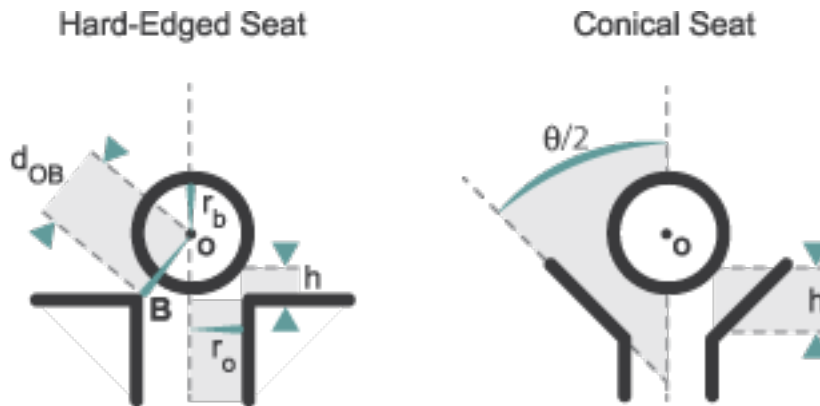

Valve Geometries

Flow Rate

The volumetric flow rate through the valve is a function of the opening area, $A(h)$, and of the pressure differential between the valve ports:

$$q = C_D A(h) \sqrt{\frac{2}{\rho} \frac{\Delta p}{(\Delta p)^2 + p_{Cr}^2}}^{1/4},$$

where:

- C_D is the flow discharge coefficient.

- ρ is the hydraulic fluid density.
- Δp is the pressure differential between the valve ports, defined as:

$$\Delta p = p_A - p_B,$$

where p_A is the pressure at port **A** and p_B is the pressure at port **B**.

- p_{Cr} is the minimum pressure required for turbulent flow.

The critical pressure p_{Cr} is computed from the critical Reynolds number as:

$$p_{Cr} = \frac{\rho}{2} \left(\frac{Re_{Cr} \nu}{C_D D_H} \right)^2,$$

where:

- Re_{Cr} is the critical Reynolds number.
- ν (nu) is the hydraulic fluid dynamic viscosity.
- D_H is the orifice hydraulic diameter:

$$D_H = \begin{cases} D_H^{Min}, & \text{if } h \leq 0 \\ D_H^{Max} + D_H^{Min}, & \text{if } h \geq h_{Max}, \\ \frac{4A}{l} + D_H^{Min}, & \text{otherwise} \end{cases}$$

in which:

- D_H^{Min} is the minimum hydraulic diameter, corresponding to the smallest attainable flow area, the leakage flow area.
- D_H^{Max} is the maximum hydraulic diameter, corresponding to the largest attainable flow area, that of the valve in the fully open position.
- l is the wetted length of the valve perimeter—which can, but need not, be that of a circle.

Assumptions

Fluid inertia is assumed to be negligible.

Ports

Input

S — Ball displacement, m

physical signal

Physical signal input port for the ball displacement.

Conserving

A — Valve inlet

hydraulic (isothermal liquid)

Hydraulic (isothermal liquid) conserving port associated with the valve inlet.

B – Valve outlet

hydraulic (isothermal liquid)

Hydraulic (isothermal liquid) conserving port associated with the valve outlet.

Parameters**Parameters Tab****Valve seat specification – Valve seat geometry type**

Sharp-edged (default) | Conical

Geometry of the valve seat. The choice of geometry impacts the opening characteristics of the valve. See the block description for the valve opening calculations.

Cone angle – Angle between sloping edges of transverse seat cross section

120 deg (default) | scalar in units of rotation

Angle between the sloping edges of the seat in a transverse cross-sectional view.

Ball diameter – Diameter of the ball control element

0.01 m (default) | scalar in units of length

Diameter of the ball control element. This diameter must be greater than that specified for the orifice.

Orifice diameter – Diameter of the valve orifice

0.005 m (default) | scalar in units of length

Diameter of the valve orifice. This diameter must be smaller than that specified for the ball control element.

Ball displacement offset – Neutral position of ball control element

0 m (default) | scalar in units of length

Neutral position of the ball control element. The neutral position is that to which the ball returns when the displacement signal is zero. This parameter must be greater than or equal to zero.

Discharge coefficient – Semi-empirical parameter for valve capacity characterization

0.7 (default) | unitless scalar between 0 and 1

Ratio of the actual and theoretical flow rates through the valve. This parameter depends on the geometrical properties of the valve. Values are usually provided in textbooks and manufacturer data sheets.

Leakage area – Internal leakage area between valve inlets1e-12 m² (default) | positive scalar in units of area

Total area of internal leaks in the completely closed state. The purpose of this parameter is to maintain the numerical integrity of the fluid network by preventing a portion of that network from becoming isolated when the valve is completely closed.

Laminar transition specification – Choice of parameter used to define the laminar-turbulent transition

Pressure ratio (default) | Reynolds number

Select the parameter to base the laminar-turbulent transition on. Options include:

- **Pressure ratio** — Flow transitions between laminar and turbulent at the pressure ratio specified in the **Laminar flow pressure ratio** parameter. Use this option for the smoothest and most numerically robust flow transitions.
- **Reynolds number** — The transition occurs at the Reynolds number specified in the **Critical Reynolds number** parameter. Flow transitions are more abrupt and can cause simulation issues at near-zero flow rates.

Laminar flow pressure ratio — Pressure ratio at the laminar-turbulent flow transition

0.999 (default) | unitless scalar between 0 and 1

Pressure ratio at which the flow transitions between the laminar and turbulent regimes. The pressure ratio is the fraction of the outlet pressure over the inlet pressure.

Dependencies

This parameter is active when the **Laminar transition specification** parameter is set to **Pressure ratio**.

Critical Reynolds number — Reynolds number at the laminar-turbulent flow transition

12 (default) | unitless positive scalar

Maximum Reynolds number for laminar flow. This parameter depends on the orifice geometrical profile. You can find recommendations on the parameter value in hydraulics textbooks. The default value, 12, corresponds to a round orifice in thin material with sharp edges.

Dependencies

This parameter is active when the **Laminar transition specification** parameter is set to **Reynolds number**.

Variables Tab

Flow Rate — Volumetric flow rate through the valve at time zero

0.001 m³/s (default) | scalar number in units of volume per unit time

Volumetric flow rate through the valve at time zero. Simscape software uses this parameter to guide the initial configuration of the component and model. Initial variables that conflict with each other or are incompatible with the model may be ignored. Set the **Priority** column to **High** to prioritize this variable over other, low-priority, variables.

Pressure drop — Pressure drop from port A to port B at time zero

0 Pa (default) | scalar number in units of pressure

Pressure drop from port A to port B at time zero. The pressure drop is positive if pressure is greater at port A than at port B. Simscape software uses this parameter to guide the initial configuration of the component and model. Initial variables that conflict with each other or are incompatible with the model may be ignored. Set the **Priority** column to **High** to prioritize this variable over other, low-priority, variables.

Extended Capabilities

C/C++ Code Generation

Generate C and C++ code using Simulink® Coder™.

See Also

Gate Valve | Needle Valve | Poppet Valve | Pressure-Compensated Flow Control Valve

Topics

“Upgrading Simscape Fluids Models Containing Hydraulics (Isothermal) Blocks”

Introduced in R2006a

Ball Valve (G)

Valve with longitudinally translating ball as control element

Library: Simscape / Fluids / Gas / Valves & Orifices / Flow Control Valves



Description

The Ball Valve (G) block models an orifice with a translating ball that moderates flow through the valve. In the fully closed position, the ball rests at the perforated *seat*, fully blocking fluid from passing between ports **A** and **B**. The area between the ball and seat is the opening area of the valve.

The block supports subsonic flows up to the valve critical pressure, when choking occurs and the velocity downstream of the orifice remains constant. The block does not support supersonic flow.

Ball Mechanics

The block models the displacement of the ball but not valve opening or closing dynamics. The signal at port **L** provides the normalized valve position. The overall ball position is the sum of the variable displacement received at port **L**, L , and its initial **Valve lift control offset**, L_0 : $h(L) = L + h_0$. Note that h and L_0 are normalized distances between 0 and 1, indicating a fully closed valve and a fully open valve, respectively.

Numerical Smoothing

Numerical smoothing can be applied to soften discontinuities in the simulation when the valve is in the near-open or near-closed position. A 3rd-order polynomial approximates the ball position in these regions, as shown in the two figures below:

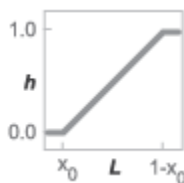

Simulated valve position without smoothing

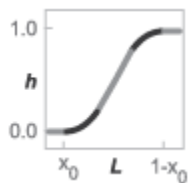

Simulated valve position with smoothing

Opening Area

The opening area of the valve depends on the **Valve seat geometry**, which can be either **Sharp-edged** or **Conical**. A **Leakage area** is defined for small contact gaps between the ball and seat in the fully closed position. This parameter also maintains continuity in the flow for solver performance.

Sharp-Edged Seat

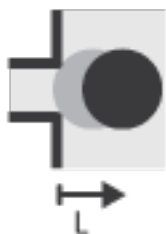

Conical Seat



Ball Valve Seat Types

The opening area for a sharp-edged seat is:

$$S = 2\pi R_0 OC \left[1 - \left(\frac{R_B}{OC} \right)^2 \right] + S_{\text{Leak}}$$

where:

- R_0 is the orifice radius.
- d is the distance between the orifice center and orifice edge.
- R_B is the ball radius.
- A_{Leak} is the **Leakage area**.

The opening area of a conical seat is:

$$S = 2\pi R_B h \rho \sin(\theta) + \pi h^2 \rho^2 \sin(\theta) \sin\left(\frac{\theta}{2}\right) + S_{\text{Leak}}$$

where:

- h_{max} is the maximum ball distance from the valve seat.
- h is the position of the ball.
- θ is the **Cone angle**.

Valve Parameterizations

There are four valve parameterization options for calculating the valve mass flow rate:

- Sonic conductance
- Flow coefficient C_v
- Flow factor K_v
- Compute from geometry

Sonic Conductance

The mass flow rate depends on opening area and the sonic conductance of the valve. Sonic conductance is a property of an orifice that characterizes flow transition between subsonic and supersonic regimes. When **Valve parameterization** is set to **Sonic conductance**, sonic conductance is treated as linearly proportional to opening area:

$$C(S) = \frac{S}{S_{\text{Max}}} C_{\text{Max}},$$

where

- C is the sonic conductance.
- C_{Max} is the **Sonic conductance at maximum flow**. For ball valves in a physical system, this value is usually stated in the manufacturer's specifications.
- S_{Max} is the maximum valve opening area, calculated from the **Orifice diameter** and **Leakage area**.

Flow Coefficients

If sonic conductance is not known, the mass flow rate can be calculated from:

- The flow coefficient, C_v . This coefficient is defined for Imperial System units.

The sonic conductance is computed from the **Cv coefficient (USCS) at maximum flow** parameter as:

$$C = (4 \times 10^{-8} C_v) m^3 / (sPa),$$

- The flow factor, K_v . This coefficient is defined for SI units.

The sonic conductance is computed from the **Kv coefficient (SI) at maximum flow** parameter as:

$$C = (4.758 \times 10^{-8} K_v) m^3 / (sPa),$$

Compute From Geometry

In this parameterization, the sonic conductance is calculated from the geometry of valve opening, based on the formulations for area, A , in Opening Area above. The sonic conductance is calculated from the geometry as:

$$C = 0.512 \frac{A}{\pi}.$$

Mass Flow Rate

Continuity

The fluid mass flowing through the valve is conserved:

$$\dot{m}_A + \dot{m}_B = 0.$$

Choked Flow

When the flow is choked, the mass flow rate is a function of the sonic conductance, C , and of the valve inlet pressure and temperature:

$$\dot{m}_{\text{ch}} = C\rho_0 p_{\text{in}} \sqrt{\frac{T_0}{T_{\text{in}}}},$$

where:

- ρ_0 is the gas **Reference density**.
- p_{in} is the inlet pressure.
- T_0 is the gas **Reference temperature**.
- T_{in} is the inlet temperature.

Subsonic Turbulent Flow

When the flow is in the turbulent, subsonic regime, the mass flow rate is:

$$\dot{m}_{\text{tur}} = C\rho_0 p_{\text{in}} \sqrt{\frac{T_0}{T_{\text{in}}}} \left[1 - \left(\frac{p_r - b_{\text{cr}}}{1 - b_{\text{cr}}} \right)^2 \right]^m,$$

where:

- p_r is the ratio between the inlet and outlet pressures: $p_r = \frac{p_{\text{out}}}{p_{\text{in}}}$.
- b_{cr} is the **Critical pressure ratio** for choked flow. When **Valve parameterization** is set to Cv coefficient (USCS) or Kv coefficient (SI), b_{cr} is 0.3.
- m is the **Subsonic index**, an empirical constant that characterizes subsonic flows. When **Valve parameterization** is set to Cv coefficient (USCS) or Kv coefficient (SI), m is 0.5.

Subsonic Laminar Flow

When the flow is in the laminar subsonic regime, the mass flow rate is:

$$\dot{m}_{\text{lam}} = C\rho_0 p_{\text{in}} \left[\frac{1 - p_r}{1 - b_{\text{lam}}} \right] \sqrt{\frac{T_0}{T_{\text{in}}}} \left[1 - \left(\frac{b_{\text{lam}} - b_{\text{cr}}}{1 - b_{\text{cr}}} \right)^2 \right]^m$$

where b_{lam} , the **Laminar flow pressure ratio**, is the pressure ratio associated with the flow transition from laminar to turbulent regime.

Energy Balance

The valve is adiabatic:

$$\phi_A + \phi_B = 0,$$

where ϕ is the energy flow rate. The sign convention is positive for energy flows into the valve.

Ports

Conserving

A — Liquid port

gas

Entry or exit point to the valve.

B — Liquid port

gas

Entry or exit point to the valve.

Input

L — Normalized ball displacement, in the range of [0,1]

physical signal

Normalized ball displacement. The ball position, which does not include any initial valve offset is normalized by the maximum opening distance. A value of 0 indicates a fully closed valve and a value of 1 indicates a fully open valve.

Parameters

Valve seat specification — Definition of valve seat geometry

Sharp-edged (default) | Conical

Geometry of the seat of the ball. This parameter determines the opening area of the valve.

Cone angle — Angle between the conical seat of the valve and its center lines

120 deg (default) | positive scalar

Angle formed by the slope of the conical seat against its center line.

Dependencies

To enable this parameter, set **Valve seat specification** to Conical.

Ball diameter — Diameter of the ball used to regulate valve opening

0.01 m (default) | scalar

Diameter of the ball control element.

Orifice diameter — Diameter of the valve orifice

7e-3 m (default) | scalar

Diameter of the valve constant orifice. For a conical geometry, the diameter the root of the seat.

Valve lift control offset — Initial distance between the ball and seat

0 (default) | scalar

Initial distance between the ball and seat. The instantaneous ball position is calculated during simulation as the sum of this offset and the control signal specified at port **L**. The valve is partially open in its normal position when the offset is a fraction between 0 and 1.

Valve parameterization — Valve opening characterization

Compute from geometry (default) | Sonic conductance | Cv coefficient (USCS) | Kv coefficient (SI)

Valve opening parameterization. The mass flow rate through the valve is calculated using the sonic conductance provided in Sonic conductance, or is calculated from valve geometry in Compute from geometry or flow coefficients C_v in Cv coefficient (USCS), K_v in Kv coefficient (SI).

Sonic conductance at maximum flow — Sonic conductance at maximum flow rate through valve

1.6 l/s/bar (default) | positive scalar

Valve characteristic, influenced by opening area and inlet-outlet pressure ratio, at the maximum flow rate through the valve. Sonic conductance is defined as the ratio of the mass flow rate through the valve to the product of the pressure and density upstream of the valve inlet. This parameter is often referred to in the literature as the *C-value*. This is the value generally reported by manufacturers in technical data sheets.

Dependencies

To enable this parameter, set **Valve parameterization** to Sonic conductance.

Critical pressure ratio — Pressure ratio at maximum flow rate

0.3 (default) | positive scalar in the range of [0,1]

Ratio of downstream to upstream pressures that leads to choked flow in the valve. This parameter is often referred to in the literature as the *b-value*.

Dependencies

To enable this parameter, set **Valve parameterization** to Sonic conductance.

Subsonic index — Subsonic index

0.5 (default) | positive scalar

Empirical value that characterizes subsonic flows. This parameter is sometimes referred to as the *m-index*. Components with fixed paths, such as a valve, have a subsonic index of approximately 0.5.

Dependencies

To enable this parameter, set **Valve parameterization** to Sonic conductance.

Cv coefficient (USCS) at maximum flow — Flow coefficient for equations in Imperial units

0.4 (default) | positive scalar

Flow coefficient of the fully open valve, formulated for US customary units. This value is generally reported by manufacturers on technical data sheets.

Dependencies

To enable this parameter, set **Valve parameterization** to Cv coefficient (USCS).

Kv coefficient (SI) at maximum flow — Flow factor for equations in SI units

0.3 (default) | positive scalar

Flow coefficient of the fully open valve, formulated for SI units. This value is generally reported by manufacturers on technical data sheets.

Dependencies

To enable this parameter, set **Valve parameterization** to `Kv coefficient (SI)`.

Leakage area — Open area of the valve in fully closed position

`1e-12 m^2 (default) | positive scalar`

Sum of all gaps when the valve is in fully closed position. Any area smaller than this value is saturated to the specified leakage area. This contributes to numerical stability by maintaining continuity in the flow.

Dependencies

To enable this parameter, set **Valve parameterization** to `Opening area`.

Cross-sectional area at ports A and B — Area normal to the flow path at the valve ports

`0.01 m^2 (default) | positive scalar`

Area normal to the flow path at the valve ports. The ports are assumed to be the same in size.

Laminar flow pressure ratio — Pressure ratio at the laminar-turbulent flow regime transition

`0.999 (default) | positive scalar`

Downstream-to-upstream pressure ratio when the flow regime transitions from laminar to turbulent. Typical values range from `0.995` to `0.999`.

Reference temperature — ISO 8778 reference temperature

`293.15 K (default) | scalar in units of temperature`

Temperature at standard reference atmosphere, defined as 293.15 K in ISO 8778.

Reference density — ISO 8778 reference density

`1.185 (default) | positive scalar in units of mass/volume`

Density at standard reference atmosphere, defined as 1.185 kg/m³ in ISO 8778.

Smoothing factor — Numerical smoothing factor

`0 (default)`

Introduces a layer of gradual change to the flow response when the valve is in near-open or near-closed positions. Set this value to a nonzero value less than one to increase the stability of your simulation in these regimes.

Extended Capabilities**C/C++ Code Generation**

Generate C and C++ code using Simulink® Coder™.

See Also

Variable Orifice ISO 6358 (G) | Gate Valve (G)

Introduced in R2018b

Ball Valve (TL)

Flow control valve actuated by longitudinal motion of ball element

Library: Simscape / Fluids / Thermal Liquid / Valves & Orifices / Flow Control Valves



Description

The Ball Valve (TL) block models the flow control with a ball valve in a thermal liquid network. You can specify the seat geometry as either sharp-edged or conical. The ball displacement is set by a physical signal at port S.

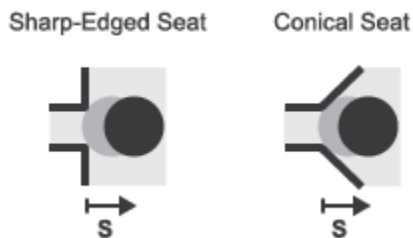

Ball Valve Seat Types

Opening Area With a Sharp-Edged Seat

When **Valve seat specification** is set to Sharp-edged, the valve opening area is based on the geometrical expression:

$$A = \pi r_o \left(1 - \left(\frac{r_b}{d_{OB}} \right)^2 \right) d_{OB}(h),$$

where:

- r_o is the valve orifice radius.
- r_b is the valve ball radius.
- $d_{OB}(h)$ is the distance between the center of the ball and the edge of the orifice. This distance is a function of the valve lift (h).

The maximum displacement, h_{\max} is:

$$h_{\max} = \sqrt{\frac{2r_b^2 - r_o^2 + r_o\sqrt{r_o^2 + 4r_b^2}}{2}} - \sqrt{r_b^2 - r_o^2}.$$

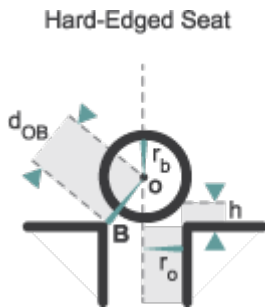

Seat Schematic

Opening Area With a Sharp-Edged Seat

When **Valve seat specification** is set to **Conical**, the valve opening area is based on the geometrical expression:

$$A = \pi r_b \sin(\theta) h + \frac{\pi}{2} \sin\left(\frac{\theta}{2}\right) \sin(\theta) h^2,$$

The maximum displacement, h_{\max} , is:

$$h_{\max} = \frac{\sqrt{r_b^2 + \frac{r_o^2}{\cos\left(\frac{\theta}{2}\right)} - r_b}}{\sin\left(\frac{\theta}{2}\right)},$$

where θ is the **Cone angle**.

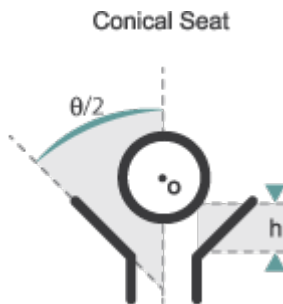

Seat Schematic

Ball Position Smoothing

A smoothing function allows the valve opening area to change smoothly between the fully closed and fully open positions. The smoothing function does this by removing the curve discontinuities at the zero and maximum ball positions.

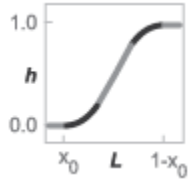

Opening-Area Curve Smoothing

The valve smoothing function is:

$$\lambda = 3\bar{h}^2 - 2\bar{h}^3$$

When the valve is nearly closed, \bar{h} is:

$$\bar{h}_C = \frac{h}{\Delta h_{smooth}}$$

When the valve is nearly open, \bar{h} is:

$$\bar{h}_O = \frac{h - (h_{max} - \Delta h_{smooth})}{h_{max} - (h_{max} - \Delta h_{smooth})}$$

Δh_{smooth} is the valve lift smoothing region:

$$\Delta h_{smooth} = f_{smooth} \frac{h_{Max}}{2}$$

where f_{smooth} is the **Smoothing factor**, which can vary from 0 to 1.

The smoothed valve opening area is given by the piecewise conditional expression:

$$S_R = \begin{cases} S_{Leak}, & h \leq 0 \\ S_{Leak}(1 - \lambda_L) + (A + S_{Leak})\lambda_L, & h < \Delta h_{smooth} \\ A + S_{Leak}, & h \leq h_{Max} - \Delta h_{smooth} \\ (A + S_{Leak})(1 - \lambda_R) + (S_{Leak} + S_{Max})\lambda_R, & h < h_{Max} \\ S_{Leak} + S_{Max}, & h \geq h_{Max} \end{cases}$$

where:

- S_R is the smoothed valve opening area.
- S_{Leak} is the valve **Leakage area**.
- S_{Max} is the maximum valve opening area:

$$S_{Max} = \pi r_o^2$$

Momentum Balance

The pressure differential over the valve is:

$$p_A - p_B = \frac{\dot{m} \sqrt{\dot{m}^2 + \dot{m}_{cr}^2}}{2\rho_{Avg} C_d^2 S^2} \left[1 - \left(\frac{S_R}{S} \right)^2 \right] PR_{Loss}$$

where:

- p_A is the pressure at port **A**.
- p_B is the pressure at port **B**.
- \dot{m} is the mass flow rate.
- ρ_{Avg} is the average liquid density.
- C_d is the **Discharge coefficient**.
- \dot{m}_{cr} is the critical mass flow rate:

$$\dot{m}_{cr} = Re_{cr} \mu_{Avg} \sqrt{\frac{\pi}{4}} S_R.$$

where:

- Re_{cr} is the **Critical Reynolds number**.
- μ_{Avg} is the average fluid dynamic viscosity.
- S is the **Cross-sectional area at port A and B**.
- PR_{Loss} is the pressure ratio:

$$PR_{Loss} = \frac{\sqrt{1 - (S_R/S)^2(1 - C_d^2)} - C_d(S_R/S)}{\sqrt{1 - (S_R/S)^2(1 - C_d^2)} + C_d(S_R/S)}.$$

Mass Balance

The mass conservation equation in the valve is

$$\dot{m}_A + \dot{m}_B = 0,$$

where:

- \dot{m}_A is the mass flow rate into the valve through port **A**.
- \dot{m}_B is the mass flow rate into the valve through port **B**.

Energy Balance

The energy conservation equation in the valve is

$$\phi_A + \phi_B = 0,$$

where:

- ϕ_A is the energy flow rate into the valve through port **A**.
- ϕ_B is the energy flow rate into the valve through port **B**.

Ports

- A — Thermal liquid conserving port representing valve inlet A
- B — Thermal liquid conserving port representing valve inlet B

- S — Physical signal input port for the control member displacement

Parameters

Parameters Tab

Valve seat specification

Choice of valve seat geometry. Options include Sharp-edged and Conical. The default setting is Sharp-edged.

Cone angle

Angle formed by the sides of the conical seat. This parameter is active only when the **Valve seat specification** parameter is active. The default value is 120 deg.

Ball diameter

Diameter of the spherical control member. The default value is 0.01 m.

Orifice diameter

Diameter of the valve opening. The default value is 7e-3 m.

Ball displacement offset

Control member offset from the zero position. The control member displacement is the sum of the input signal S and the displacement offset specified. The default value is 0 m.

Leakage area

Area through which fluid can flow in the fully closed valve position. This area accounts for leakage between the valve inlets. The default value is 1e-12 m².

Smoothing factor

Portion of the opening-area curve to smooth expressed as a fraction. Smoothing eliminates discontinuities at the minimum and maximum flow valve positions. The smoothing factor must be between 0 and 1. Enter a value of 0 for zero smoothing. Enter a value of 1 for full-curve smoothing. The default value is 0.01.

Cross-sectional area at ports A and B

Area normal to the direction of flow at the valve inlets. This area is assumed the same for all the inlets. The default value is 0.01 m².

Characteristic longitudinal length

Distance traversed by the fluid between the valve inlets. The default value is 0.1 m².

Discharge coefficient

Ratio of the actual mass flow rate through the valve to its ideal, or theoretical, value. The discharge coefficient accounts for the effects of valve geometry. The value must be between 0 and 1.

Critical Reynolds number

Reynolds number at which flow transitions between laminar and turbulent regimes. Flow is laminar below this number and turbulent above it. The default value is 12.

Variables Tab

Mass flow rate into port A

Mass flow rate into the component through port A at the start of simulation. The default value is 1 kg/s.

Extended Capabilities

C/C++ Code Generation

Generate C and C++ code using Simulink® Coder™.

See Also

Gate Valve (TL)

Introduced in R2016a

Cartridge Valve Insert

Hydraulic cartridge valve insert



Library

Directional Valves

Description

The Cartridge Valve Insert block represents an insert of a hydraulic cartridge valve consisting of a poppet interacting with the seat. The poppet position is determined by pressures at ports A, B, and X and force of the spring. A schematic diagram of the cartridge valve insert is shown in the following illustration.

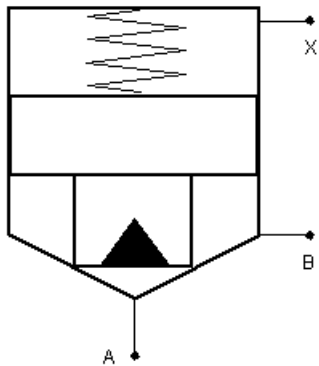

The Cartridge Valve Insert block is a structural model consisting of a Hydraulic Cartridge Valve Actuator block and a Variable Orifice block, as shown in the next illustration.

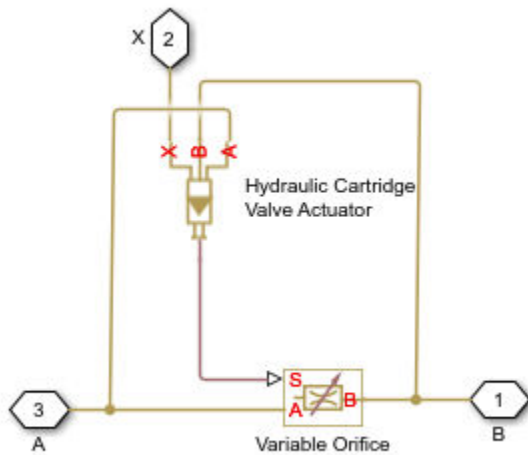

Pressures at port A and port B tend to open the valve, while pressure at the control port X, together with the spring, acts to close it. The model does not account for flow rates caused by poppet displacement and any loading on the poppet, such as inertia and friction. The valve remains closed as long as the aggregate pressure force is lower than the spring preload force. The poppet is forced off its seat as the preload force is reached and moves up proportionally to pressure increase until it passes the full stroke. Hydraulic properties of the gap between the poppet and the seat are simulated with the Variable Orifice block.

Connections A, B, and X are hydraulic conserving ports associated with the valve inlet, valve outlet, and valve control terminal, respectively. The block positive direction is from port A to port B. Pressure at port X acts to close the valve, while pressures at port A and port B act to open the orifice.

Basic Assumptions and Limitations

- Valve opening is linearly proportional to the pressure differential.
- No loading on the poppet, such as inertia or friction, is considered.
- The model does not account for flow rates caused by poppet displacement.
- For orifices specified by the passage area (the first two parameterization options), the transition between laminar and turbulent regimes is assumed to be sharp and taking place exactly at $Re=Re_{cr}$.
- For orifices specified by pressure-flow characteristics (the third parameterization option), the model does not explicitly account for the flow regime or leakage flow rate because the tabulated data is assumed to account for these characteristics.

Parameters

Port A poppet area

Effective poppet area at port A. The parameter value must be greater than zero. The default value is $2e-4 \text{ m}^2$.

Port A to port X area ratio

Ratio between poppet areas at port A and port X. The parameter value must be greater than zero. The default value is 0.66.

Preload force

Spring preload force. The default value is 26 N.

Spring rate

Spring rate. The default value is 1.4e4 N/m.

Poppet stroke

Maximum poppet stroke. The parameter value must be greater than or equal to zero. The default value is 5e-3 m. This parameter is used if **Orifice specification** is set to **By maximum area and opening**.

Initial opening

The initial opening of the valve. Its value must be greater than or equal to zero. The default value is 0.

Orifice specification

Select one of the following methods for specifying the hydraulic properties of the gap between the poppet and the seat:

- **By maximum area and opening** — Provide values for the maximum orifice area and the maximum orifice opening. The passage area is linearly dependent on the control member displacement, that is, the orifice is closed at the initial position of the control member (zero displacement), and the maximum opening takes place at the maximum displacement. This is the default method.
- **By area vs. opening table** — Provide tabulated data of orifice openings and corresponding orifice areas. The passage area is determined by one-dimensional table lookup. You have a choice of two interpolation methods and two extrapolation methods.
- **By pressure-flow characteristic** — Provide tabulated data of orifice openings, pressure differentials, and corresponding flow rates. The flow rate is determined by two-dimensional table lookup. You have a choice of two interpolation methods and two extrapolation methods.

For more information on these options, see the Variable Orifice block reference page.

Orifice maximum area

Specify the area of a fully opened orifice. The parameter value must be greater than zero. The default value is 5e-5 m². This parameter is used if **Orifice specification** is set to **By maximum area and opening**.

Tabulated orifice openings

Specify the vector of input values for orifice openings as a one-dimensional array. The input values vector must be strictly increasing. The values can be nonuniformly spaced. The minimum number of values depends on the interpolation method: you must provide at least two values for linear interpolation, at least three values for smooth interpolation. The default values, in meters, are [-0.002 0 0.002 0.005 0.015]. If **Orifice specification** is set to **By area vs. opening table**, the **Tabulated orifice openings** values will be used together with **Tabulated orifice area** values for one-dimensional table lookup. If **Orifice specification** is set to **By pressure-flow characteristic**, the **Tabulated orifice openings** values will be used together with **Tabulated pressure differentials** and **Tabulated flow rates** for two-dimensional table lookup.

Tabulated orifice area

Specify the vector of orifice areas as a one-dimensional array. The vector must be of the same size as the orifice openings vector. All the values must be positive. The default values, in m², are

[1e-09 2.0352e-07 4.0736e-05 0.00011438 0.00034356]. This parameter is used if **Orifice specification** is set to By area vs. opening table.

Tabulated pressure differentials

Specify the pressure differential vector as a one-dimensional array. The vector must be strictly increasing. The values can be nonuniformly spaced. The minimum number of values depends on the interpolation method: you must provide at least two values for linear interpolation, at least three values for smooth interpolation. The default values, in Pa, are [-1e+07 -5e+06 -2e+06 2e+06 5e+06 1e+07]. This parameter is used if **Orifice specification** is set to By pressure-flow characteristic.

Tabulated flow rates

Specify the flow rates as an m-by-n matrix, where m is the number of orifice openings and n is the number of pressure differentials. Each value in the matrix specifies flow rate taking place at a specific combination of orifice opening and pressure differential. The matrix size must match the dimensions defined by the input vectors. The default values, in m³/s, are:

```
[-1e-07 -7.0711e-08 -4.4721e-08 4.4721e-08 7.0711e-08 1e-07;
-2.0352e-05 -1.4391e-05 -9.1017e-06 9.1017e-06 1.4391e-05 2.0352e-05;
-0.0040736 -0.0028805 -0.0018218 0.0018218 0.0028805 0.0040736;
-0.011438 -0.0080879 -0.0051152 0.0051152 0.0080879 0.011438;
-0.034356 -0.024293 -0.015364 0.015364 0.024293 0.034356;]
```

This parameter is used if **Orifice specification** is set to By pressure-flow characteristic.

Interpolation method

Select one of the following interpolation methods for approximating the output value when the input value is between two consecutive grid points:

- **Linear** — Select this option to get the best performance.
- **Smooth** — Select this option to produce a continuous curve (By area vs. opening table) or surface (By pressure-flow characteristic) with continuous first-order derivatives.

For more information on interpolation algorithms, see the PS Lookup Table (1D) and PS Lookup Table (2D) block reference pages.

Extrapolation method

Select one of the following extrapolation methods for determining the output value when the input value is outside the range specified in the argument list:

- **Linear** — Select this option to produce a curve or surface with continuous first-order derivatives in the extrapolation region and at the boundary with the interpolation region.
- **Nearest** — Select this option to produce an extrapolation that does not go above the highest point in the data or below the lowest point in the data.

For more information on extrapolation algorithms, see the PS Lookup Table (1D) and PS Lookup Table (2D) block reference pages.

Flow discharge coefficient

Semi-empirical parameter for valve capacity characterization. Its value depends on the geometrical properties of the orifice, and usually is provided in textbooks or manufacturer data sheets. The default value is 0.7.

Laminar transition specification

Select how the block transitions between the laminar and turbulent regimes:

- **Pressure ratio** — The transition from laminar to turbulent regime is smooth and depends on the value of the **Laminar flow pressure ratio** parameter. This method provides better simulation robustness.
- **Reynolds number** — The transition from laminar to turbulent regime is assumed to take place when the Reynolds number reaches the value specified by the **Critical Reynolds number** parameter.

Laminar flow pressure ratio

Pressure ratio at which the flow transitions between laminar and turbulent regimes. The default value is 0.999. This parameter is visible only if the **Laminar transition specification** parameter is set to **Pressure ratio**.

Critical Reynolds number

The maximum Reynolds number for laminar flow. The value of the parameter depends on the orifice geometrical profile. You can find recommendations on the parameter value in hydraulics textbooks. The default value is 12, which corresponds to a round orifice in thin material with sharp edges. This parameter is visible only if the **Laminar transition specification** parameter is set to **Reynolds number**.

Leakage area

The total area of possible leaks in the completely closed valve. The main purpose of the parameter is to maintain numerical integrity of the circuit by preventing a portion of the system from getting isolated after the valve is completely closed. The parameter value must be greater than 0. The default value is $1e-12 \text{ m}^2$.

Time constant

Sets the time constant of the first-order lag, which is introduced between the required and the actual poppet positions to account for actuator dynamics. The parameter value must be greater than zero. The default value is 0.01 s.

Restricted Parameters

When your model is in Restricted editing mode, you cannot modify the following parameters:

- **Orifice specification**
- **Interpolation method**
- **Extrapolation method**

All other block parameters are available for modification. The actual set of modifiable block parameters depends on the value of the **Orifice specification** parameter at the time the model entered Restricted mode.

Global Parameters

Parameters determined by the type of working fluid:

- **Fluid density**
- **Fluid kinematic viscosity**

Use the Hydraulic Fluid block or the Custom Hydraulic Fluid block to specify the fluid properties.

Ports

The block has the following ports:

A

Hydraulic conserving port associated with the valve inlet.

B

Hydraulic conserving port associated with the valve outlet.

X

Hydraulic conserving port associated with the valve control terminal.

Extended Capabilities

C/C++ Code Generation

Generate C and C++ code using Simulink® Coder™.

See Also

Cartridge Valve Insert with Conical Seat | Check Valve | Hydraulic Cartridge Valve Actuator | Pilot-Operated Check Valve

Topics

“Upgrading Simscape Fluids Models Containing Hydraulics (Isothermal) Blocks”

Introduced in R2008a

Cartridge Valve Actuator (IL)

Actuator that maintains equilibrium between valve and pilot pressures in an isothermal liquid system

Library: Simscape / Fluids / Valve Actuators & Forces

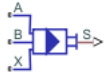

Description

The Cartridge Valve Actuator (IL) block models an actuator that maintains equilibrium between the valve and pilot-line pressures. The valve between ports **A** and **B** remains closed until the pilot spring **Spring preload force** is surpassed, at which point the piston begins to move. The piston position is output as a physical signal at port **S**. A schematic of a 4-port cartridge valve actuator is shown below.

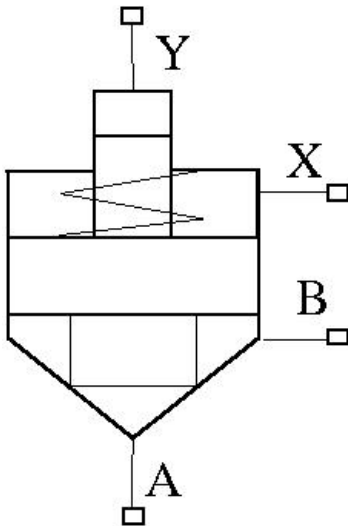

Actuator Force Balance

The actuator piston moves to adjust the pressure in the actuator chamber, which maintains equilibrium between the actuator port pressures and pilot line pressures:

$$p_A A_A + p_B A_B = F_{preload} + F_{pilot},$$

where:

- p_A and p_B are the pressures at ports **A** and **B**.
- A_X is calculated from the **Port A to port X area ratio**.
- A_B is the port **B** area, $A_X - A_A$, when the **Number of pressure ports** is set to 3. When the **Number of pressure ports** is set to 4, A_B is $A_X - A_A + A_Y$.
- $F_{preload}$ is the initial spring force in the system.
- F_{pilot} is $p_X A_X$ if **Number of pressure ports** is set to 3 and $p_X A_X + p_Y A_Y$ if **Number of pressure ports** is set to 4.

Piston Position

The steady piston displacement is calculated as:

$$x_{steady} = \frac{F\varepsilon}{k} = \frac{F_A + F_B - F_{pilot} - F_{preload}}{k}\varepsilon,$$

where ε is the **Opening orientation**, which assigns movement in a positive direction (extension) or negative direction (retraction). The dynamic change in piston displacement is:

$$\dot{x}_{dyn} = \frac{x_{steady} - x_{dyn}}{\tau},$$

where τ is the **Actuator time constant**. When $\dot{x}_{dyn} = \frac{x_{dyn}}{\tau}$ is less than the **Spring preload force**, $x_{steady} = 0$.

If $\dot{x}_{dyn} = \frac{x_{dyn}}{\tau}$ is greater than the sum of the preload force and kx_{stroke} , $x_{steady} = x_{stroke}$.

Opening Dynamics

If opening dynamics are modeled, a lag is introduced to the flow response to the modeled control pressure. $p_{control}$ becomes the dynamic control pressure, p_{dyn} ; otherwise, $p_{control}$ is the steady-state pressure. The instantaneous change in dynamic control pressure is calculated based on the **Opening time constant**, τ :

$$\dot{p}_{dyn} = \frac{p_{control} - p_{dyn}}{\tau}.$$

By default, **Opening dynamics** is set to **Off**.

Numerically-Smoothed Force

When the actuator is close to full extension or full retraction, you can maintain numerical robustness in your simulation by adjusting the block **Smoothing factor**. A smoothing function is applied to all calculated forces, but primarily influences the simulation at the extremes of the piston motion.

The normalized force is calculated as:

$$\widehat{F} = \frac{F_A + F_B - F_{Preload} - F_{Pilot}}{kx_{stroke}}.$$

The **Smoothing factor**, s , is applied to the normalized force:

$$\widehat{F}_{X, smoothed} = \frac{1}{2} + \frac{1}{2}\sqrt{\widehat{F}_X^2 + \left(\frac{s}{4}\right)^2} - \frac{1}{2}\sqrt{(\widehat{F}_X - 1)^2 + \left(\frac{s}{4}\right)^2},$$

Assumptions and Limitations

Internal fluid volumes are not modeled in this block. There is no mass flow rate through ports **A**, **B**, **X**, and **Y**.

Ports

Conserving

A – Pressure port

isothermal liquid

Pressure port associated with the valve inlet.

B – Pressure port

isothermal liquid

Pressure port associated with the valve outlet.

X – Pressure port

isothermal liquid

Pressure port at poppet end.

Y – Pressure port

isothermal liquid

Pilot pressure port. To enable this port, set **Number of pressure ports** to 4.

Output

S – Poppet position, m

physical signal

Poppet position in m, specified as a physical signal.

Parameters

Number of pressure ports – Number of pilot pressure ports

3 (default) | 4

Number of pilot pressure ports. Port **X** measures the pressure at the end of the poppet. Setting this parameter to 4 enables the additional pilot-side port **Y**.

Port A poppet area – Cross-sectional area of port A

$1e-4 \text{ m}^2$ (default) | positive scalar

Cross-sectional area of port **A**.

Port A poppet to port X pilot area ratio – Ratio of inlet to pilot port area

0.5 (default) | positive scalar

Ratio of the inlet port, **A**, to the pilot pressure port, **X**. This value is used to calculate the force at port **X**.

Port Y pilot area – Cross-sectional area of port Y

$1.5e-4 \text{ m}^2$ (default) | positive scalar

Cross-sectional area of port **Y**.

Dependencies

To enable this parameter, set **Number of pressure ports** to 4.

Spring preload force — Initial spring force

25 N (default) | positive scalar

Spring force in the valve due to spring preloading. This parameter is a threshold value which, when added to the pilot pressures at ports **X** and **Y**, counterbalances the valve opening due to the pressures at ports **A** and **B**.

Spring stiffness — Stiffness constant

15e3 N/m (default) | positive scalar

Spring stiffness constant.

Poppet stroke — Maximum poppet extension

5e-3 m (default) | positive scalar

Maximum poppet extension.

Smoothing factor — Numerical smoothing factor

0.01 (default) | positive scalar in the range [0,1]

Continuous smoothing factor that introduces a layer of gradual change to the piston position when it is near full extension or full retraction. Set this value to a nonzero value less than one to increase the stability of your simulation in these regimes.

Connected valve opening orientation — Direction of poppet displacement

Positive displacement opens valve (default) | Negative displacement opens valve

Direction of the poppet displacement that opens a connected valve. Setting this parameter to **Positive displacement opens valve** indicates poppet extension. Setting the parameter to **Negative displacement opens valve** indicates poppet retraction.

Actuator dynamics — Whether to account for transients during actuation

Off (default) | On

Whether to account for transient effects in the spool position due to actuation. Setting **Actuator dynamics** to **On** approximates actuator motion by introducing a first-order lag in the spool position. The **Actuator time constant** also impacts the modeled dynamics.

Actuator time constant — Piston displacement time constant

0.1 s (default) | positive scalar

Constant that captures the time required for the piston to reach steady-state when moving from one position to another. This parameter impacts the modeled actuator dynamics.

Dependencies

To enable this parameter, set **Actuator dynamics** to **On**.

See Also

Cartridge Valve Insert (IL) | Pilot Valve Actuator (IL) | Pilot-Operated Check Valve (IL) | Shuttle Valve (IL) | 3-Way Directional Valve (IL)

Introduced in R2020a

Cartridge Valve Insert (IL)

Cartridge flow-control valve in an isothermal liquid network

Library: Simscape / Fluids / Isothermal Liquid / Valves & Orifices / Flow Control Valves



Description

The Cartridge Valve Insert (IL) block models a cartridge flow-control valve in an isothermal liquid network. The valve seat can be specified as conical or as a custom opening parameterized by analytical or tabular formulations. The valve opens when the combined pressures at ports **A** and **B** exceed the **Spring preload force** and pressure at port **X**.

You can specify the block seat geometry as either conical or a custom. This seat setting determines the sub-components that make up the block. In both configurations, the **Port A poppet to port X pilot area ratio** parameter sets the force ratio in the underlying Cartridge Valve Actuator block.

Use the Cartridge Valve Insert (IL) block when you would like flow control set by a pilot pressure line. Use the Pressure-Compensated 3-Way Flow Control Valve (IL) or Pressure-Compensated Flow Control Valve (IL) block for flow control due to a pressure differential or the Poppet Valve (IL) block for valve opening controlled by an external physical signal.

Conical Valve Seat

The conical cartridge valve insert is a composite of two Isothermal Liquid library blocks:

- Poppet Valve (IL)
- Cartridge Valve Actuator (IL)

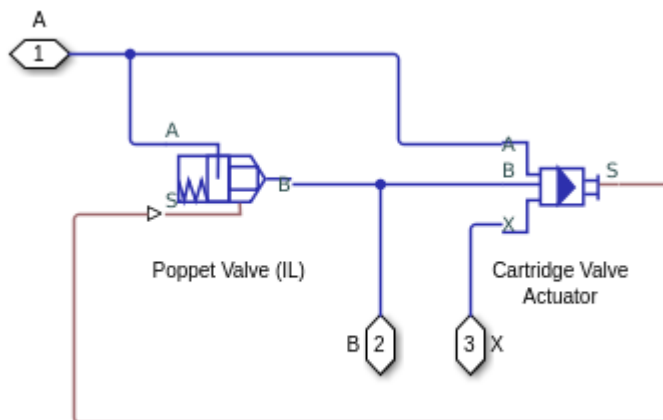

Conical Cartridge Valve Insert Schematic

Custom Valve Seat

The custom cartridge valve insert is a composite of two Isothermal Liquid library blocks:

- Orifice (IL)
- Cartridge Valve Actuator (IL)

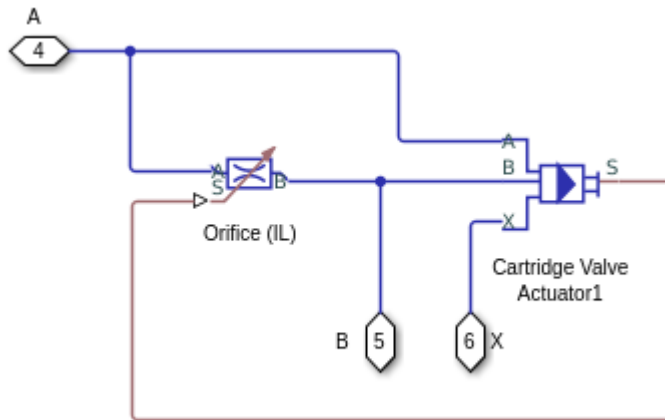

In the custom configuration, you can parameterize the valve opening analytically or with a data set.

Custom Cartridge Valve Insert Schematic

Analytical Parameterization

By setting **Orifice parameterization** to Linear - area vs. control member position, the valve opening area is linearly proportional to the poppet position. Once the pressure at port **A** or **B** exceeds the **Spring preload force**, the valve opens until the **Maximum orifice area** is reached. When the valve is fully closed, a small **Leakage area** remains open to flow so that numerical continuity is maintained in the network.

Tabulated Parameterization

By setting **Orifice parameterization** to Tabulated data - Area vs. control member position, you can supply the opening profile based on opening area and poppet position. The block queries between data points with linear interpolation and uses nearest extrapolation for points beyond the table boundaries.

By setting **Orifice parameterization** to Tabulated data - Volumetric flow rate vs. control member position and pressure drop, you can supply the volumetric flow rate through the valve as a parameterized table of poppet position and valve pressure drop. The block queries between data points with linear interpolation and uses linear extrapolation for points beyond the table boundaries. The volumetric flow rate is converted to a mass flow rate by multiplying by the fluid density.

Opening Dynamics

If opening dynamics are modeled, a lag is introduced to the flow response to the modeled control pressure. p_{control} becomes the dynamic control pressure, p_{dyn} ; otherwise, p_{control} is the steady-state pressure. The instantaneous change in dynamic control pressure is calculated based on the **Opening time constant**, τ :

$$\dot{p}_{dyn} = \frac{p_{control} - p_{dyn}}{\tau}.$$

By default, **Opening dynamics** is set to Off.

Numerically-Smoothed Force and Opening

When the actuator is close to full extension or full retraction, you can maintain numerical robustness in your simulation by adjusting the block **Smoothing factor**. A smoothing function is applied to the actuator force and orifice opening or area, but primarily influences the simulation at the extremes of these ranges.

The normalized force is calculated as:

$$\widehat{F} = \frac{F_A + F_B - F_{Preload} - F_{Pilot}}{kX_{stroke}}.$$

where:

- F_A is the force at port **A**.
- F_B is the force at port **B**.
- $F_{Preload}$ is the **Spring preload force**.
- F_{Pilot} is the force at port **X**.

The **Smoothing factor**, s , is applied to the normalized force:

$$\widehat{F}_{X, smoothed} = \frac{1}{2} + \frac{1}{2} \sqrt{\widehat{F}_X^2 + \left(\frac{s}{4}\right)^2} - \frac{1}{2} \sqrt{(\widehat{F}_X - 1)^2 + \left(\frac{s}{4}\right)^2},$$

Similarly, when **Valve seat specification** is set to Conical, the normalized orifice opening distance is:

$$\widehat{h} = \frac{h}{h_{max}},$$

where:

- h is the poppet opening distance.
- h_{max} is the maximum poppet opening distance.

The smoothed, normalized opening is:

$$\widehat{h}_{smoothed} = \frac{1}{2} + \frac{1}{2} \sqrt{\widehat{h}^2 + \left(\frac{s}{4}\right)^2} - \frac{1}{2} \sqrt{(\widehat{h} - 1)^2 + \left(\frac{s}{4}\right)^2}.$$

The smoothed opening distance is:

$$h_{smoothed} = \widehat{h}_{smoothed} h_{max}.$$

When **Valve seat specification** is set to Custom, the normalized valve area is calculated as:

$$\widehat{A} = \frac{(A_{orifice} - A_{leak})}{(A_{max} - A_{leak})}.$$

where:

- $A_{orifice}$ is the valve open area.
- A_{leak} is the **Leakage area**.
- A_{max} is the **Maximum orifice area**.

The smoothed, normalized area is:

$$\hat{A}_{smoothed} = \frac{1}{2} + \frac{1}{2}\sqrt{\hat{A}^2 + \left(\frac{S}{4}\right)^2} - \frac{1}{2}\sqrt{(\hat{A} - 1)^2 + \left(\frac{S}{4}\right)^2}.$$

The smoothed area is:

$$A_{smoothed} = \hat{A}_{smoothed}(A_{max} - A_{leak}) + A_{leak}.$$

Ports

Conserving

A – Liquid port

isothermal liquid

Liquid entry or exit port.

B – Liquid port

isothermal liquid

Liquid entry or exit port.

X – Pressure port

isothermal liquid

Pilot pressure port. There is no mass flow rate through port X.

Parameters

Valve seat specification – Geometry of valve seat

Conical (default) | Custom

Geometry of valve seat. This parameter is used for calculating the open area between the poppet and seat.

Poppet diameter – Diameter of the valve control member

0.01 m (default) | positive scalar

Diameter of the valve control member.

Dependencies

To enable this parameter, set **Valve seat specification** to Conical.

Seat cone angle – Angle of the seat opening

120 deg (default) | positive scalar

Angle of the seat opening.

Dependencies

To enable this parameter, set **Valve seat specification** to Conical.

Orifice parameterization — Method of calculating orifice area

Linear - area vs. control member position (default) | Tabulated data - Area vs. control member position | Tabulated data - Volumetric flow rate vs. control member position and pressure drop

The valve opening is calculated in one of three ways, linearly or by tabulated data:

- **Linear - area vs. control member position:** The orifice area is determined by a linear relationship to the poppet opening or closing distance.
- **Tabulated data - Area vs. control member position:** The opening area is interpolated from the **Poppet position vector** and the **Orifice area vector** based on the current poppet position.
- **Tabulated data - Volumetric flow rate vs. control member position and pressure drop.** The volumetric flow rate is directly interpolated from the provided **Poppet position vector, s**; **Pressure drop vector, dp**; and **Volumetric flow rate table, q(s,dp)** parameters, based on the current poppet position.

Dependencies

To enable this parameter, set **Valve seat specification** to Custom.

Poppet stroke — Maximum poppet extension

5e-3 m (default) | positive scalar

Maximum poppet extension.

Dependencies

To enable this parameter, set **Valve seat specification** to Custom and **Orifice parameterization** to Linear - area vs. control member position.

Maximum orifice area — Maximum orifice cross-sectional area

1e-4 m² (default) | positive scalar

Cross-sectional area of the orifice in its fully open position. This parameter is used as an upper limit for area-pressure calculations during the simulation.

Dependencies

To enable this parameter, set **Valve seat specification** to Custom and **Orifice parameterization** to Linear - area vs. control member position.

Poppet position vector — Vector of opening positions

[0, .002, .004, .007, .017] m (default) | 1-by-n vector

Vector of orifice opening positions for the tabular parameterization of the orifice opening area. The vector elements must correspond one-to-one with the elements in the **Orifice area vector** parameter. The elements are listed in ascending order and must be greater than 0.

Dependencies

To enable this parameter, set **Valve seat specification** to Custom and **Orifice parameterization** to Tabulated data - Area vs. control member position.

Orifice area vector — Vector of opening areas

[1e-09, 2.0352e-07, 4.0736e-05, .00011438, .00034356] m² (default) | 1-by-*n* vector

Vector of valve opening areas for the tabular parameterization of the valve opening area. The vector elements must correspond one-to-one with the elements in the **Poppet position vector** parameter. The elements are listed in ascending order and must be greater than 0.

Dependencies

To enable this parameter, set **Valve seat specification** to Custom and **Orifice parameterization** to Tabulated data - Area vs. control member position.

Poppet position vector, *s* — Vector of control member positions

[0, .002, .004, .007, .017] m (default) | 1-by-*n* vector

Vector of control member positions for the tabular parameterization of the volumetric flow rate. The spool travel vector forms an independent axis with the **Pressure drop vector, *dp*** parameter for the 3-D dependent **Volumetric flow rate table, *q(s,dp)*** parameter. A positive displacement corresponds to valve opening. The values are listed in ascending order and the first element must be 0. Linear interpolation is employed between table data points.

Dependencies

To enable this parameter, set **Valve seat specification** to Custom and **Orifice parameterization** to Volumetric flow rate vs. control member position and pressure drop.

Pressure drop vector, *dp* — Vector of pressure differential values

[.3, .5, .7] MPa (default) | 1-by-*n* vector

Vector of pressure drop values for tabular parametrization of volumetric flow rate. The pressure drop vector forms an independent axis with the **Poppet position vector, *s*** parameter for the 3-D dependent **Volumetric flow rate table, *q(s,dp)*** parameter. The values are listed in ascending order and must be greater than 0. Linear interpolation is employed between table data points.

Dependencies

To enable this parameter, set **Valve seat specification** to Custom and **Orifice parameterization** to Volumetric flow rate vs. control member position and pressure drop.

Volumetric flow rate table, *q(s,dp)* — Array of volumetric flow rate values

[1.7e-05, 2e-05, 2.6e-05; .0035, .0045, .0053; .7, .9, 1.06; 1.96, 2.5, 3; 6, 7.7, 9.13] .* 1e-3 m³/s (default) | *M*-by-*N* array

Matrix of volumetric flow rates based on independent values of pressure drop and spool travel distance. *M* and *N* are the sizes of the corresponding vectors:

- *M* is the number of elements in the **Poppet position vector, *s*** parameter.
- *N* is the number of elements in the **Pressure drop vector, *dp*** parameter.

Dependencies

To enable this parameter, set **Valve seat specification** to Custom and **Orifice parameterization** to Volumetric flow rate vs. control member position and pressure drop.

Port A poppet area — Cross-sectional area of port A

1e-4 m² (default) | positive scalar

Cross-sectional area of port A.

Port A poppet to port X pilot area ratio — Ratio of inlet to pilot port area

0.5 (default) | positive scalar

Ratio of the inlet port, **A**, to the pilot pressure port, **X**. This value is used to calculate the force at port **X**. The ratio must be less than or equal to 1.

Spring preload force — Spring force in neutral poppet position

25 N (default) | positive scalar

Spring force on the poppet when the poppet is in the neutral position. This parameter is a threshold value which, when added to the pilot pressure at port **X**, counterbalances the valve opening due to the pressures at ports **A** and **B**.

Spring stiffness — Stiffness constant

15e3 N/m (default) | positive scalar

Spring stiffness constant.

Leakage area — Gap area when in fully closed position

1e-10 m² (default) | positive scalar

Sum of all gaps when the valve is in the fully closed position. Any area smaller than this value is saturated to the specified leakage area. This contributes to numerical stability by maintaining continuity in the flow.

Dependencies

To enable this parameter, set either:

- **Valve seat specification** to Conical.
- **Valve seat specification** to Custom and **Orifice parameterization** to Linear - Area vs. control member position.

Discharge coefficient — Discharge coefficient

0.64 (default) | positive scalar

Correction factor that accounts for discharge losses in theoretical flows.

Dependencies

To enable this parameter, set either:

- **Valve seat specification** to Conical.
- **Valve seat specification** to Custom and **Orifice parameterization** to Linear - Area vs. control member position or Tabulated data - Area vs. control member position.

Critical Reynolds number — Upper Reynolds number limit for laminar flow

150 (default) | positive scalar

Upper Reynolds number limit for laminar flow through the valve.

Dependencies

To enable this parameter, set either:

- **Valve seat specification** to Conical.
- **Valve seat specification** to Custom and **Orifice parameterization** to Linear - Area vs. control member position or Tabulated data - Area vs. control member position.

Smoothing factor — Numerical smoothing factor

0.01 (default) | positive scalar in the range [0,1]

Continuous smoothing factor that introduces a layer of gradual change to the flow response when the valve is in near-open or near-closed positions. Set this value to a nonzero value less than one to increase the stability of your simulation in these regimes.

Dependencies

To enable this parameter, set either:

- **Valve seat specification** to Conical.
- **Valve seat specification** to Custom and **Orifice parameterization** to Linear - Area vs. control member position.

Valve opening time constant — Valve time constant

0.1 s (default) | positive scalar

Constant that captures the time required for the fluid to reach steady-state conditions when opening or closing the valve from one position to another. This parameter impacts the modeled opening dynamics.

See Also

Cartridge Valve Actuator (IL) | Poppet Valve (IL) | Orifice (IL) | Pressure-Compensated 3-Way Flow Control Valve (IL) | Pressure-Compensated Flow Control Valve (IL)

Introduced in R2020a

Cartridge Valve Insert with Conical Seat

Hydraulic cartridge valve insert with conical seat



Library

Directional Valves

Description

The Cartridge Valve Insert with Conical Seat block represents an insert of a hydraulic cartridge valve consisting of a poppet interacting with the conical seat. The poppet position is determined by pressures at ports A, B, and X and force of the spring. A schematic diagram of the cartridge valve insert with conical seat is shown in the following illustration.

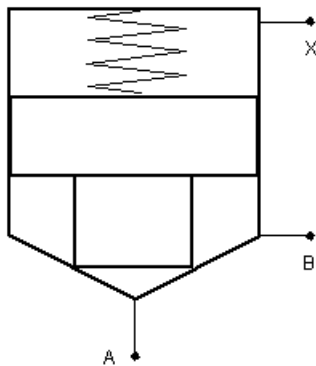

The Cartridge Valve Insert with Conical Seat block is a structural model consisting of a Hydraulic Cartridge Valve Actuator block and a Poppet Valve block, as shown in the next illustration.

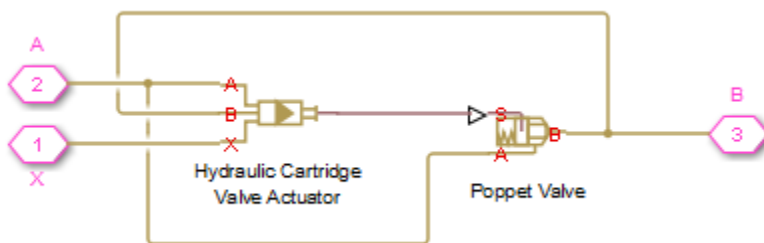

Pressures at port A and port B tend to open the valve, while pressure at the control port X, together with the spring, acts to close it. The model does not account for flow rates caused by poppet

displacement and any loading on the poppet, such as inertia and friction. The valve remains closed as long as the aggregate pressure force is lower than the spring preload force. The poppet is forced off its seat as the preload force is reached and moves up proportionally to pressure increase until it passes the full stroke. Hydraulic properties of the gap between the poppet and the seat are simulated with the Poppet Valve block.

Connections A, B, and X are hydraulic conserving ports associated with the valve inlet, valve outlet, and valve control terminal, respectively. The block positive direction is from port A to port B. Pressure at port X acts to close the valve, while pressures at port A and port B act to open the orifice.

Basic Assumptions and Limitations

- Valve opening is linearly proportional to the pressure differential.
- No loading on the poppet, such as inertia or friction, is considered.
- The model does not account for flow consumption caused by poppet displacement.

Parameters

Port A poppet area

Effective poppet area at port A. The parameter value must be greater than zero. The default value is $2e-4 \text{ m}^2$.

Port A to port X area ratio

Ratio between poppet areas at port A and port X. The parameter value must be greater than zero. The default value is 0.66.

Preload force

Spring preload force. The default value is 26 N.

Spring rate

Spring rate. The default value is $1.4e4 \text{ N/m}$.

Poppet stroke

Maximum poppet stroke. The parameter value must be greater than zero. The default value is 0.005 m.

Poppet diameter

Maximum poppet diameter. The parameter value must be greater than or equal to zero. The default value is 0.01 m.

Seat cone angle

The cone angle of the valve seat. The default value is 120 degrees.

Initial opening

The initial opening of the valve. Its value must be greater than or equal to zero. The default value is 0.

Flow discharge coefficient

Semi-empirical parameter for valve capacity characterization. Its value depends on the geometrical properties of the orifice, and usually is provided in textbooks or manufacturer data sheets. The default value is 0.7.

Laminar transition specification

Select how the block transitions between the laminar and turbulent regimes:

- **Pressure ratio** — The transition from laminar to turbulent regime is smooth and depends on the value of the **Laminar flow pressure ratio** parameter. This method provides better simulation robustness.
- **Reynolds number** — The transition from laminar to turbulent regime is assumed to take place when the Reynolds number reaches the value specified by the **Critical Reynolds number** parameter.

Laminar flow pressure ratio

Pressure ratio at which the flow transitions between laminar and turbulent regimes. The default value is 0.999. This parameter is visible only if the **Laminar transition specification** parameter is set to **Pressure ratio**.

Critical Reynolds number

The maximum Reynolds number for laminar flow. The value of the parameter depends on the orifice geometrical profile. You can find recommendations on the parameter value in hydraulics textbooks. The default value is 12, which corresponds to a round orifice in thin material with sharp edges. This parameter is visible only if the **Laminar transition specification** parameter is set to **Reynolds number**.

Leakage area

The total area of possible leaks in the completely closed valve. The main purpose of the parameter is to maintain numerical integrity of the circuit by preventing a portion of the system from getting isolated after the valve is completely closed. The parameter value must be greater than 0. The default value is $1e-12 \text{ m}^2$.

Time constant

Sets the time constant of the first-order lag, which is introduced between the required and the actual poppet positions to account for actuator dynamics. The parameter value must be greater than zero. The default value is 0.01 s.

Global Parameters

Parameters determined by the type of working fluid:

- **Fluid density**
- **Fluid kinematic viscosity**

Use the Hydraulic Fluid block or the Custom Hydraulic Fluid block to specify the fluid properties.

Ports

The block has the following ports:

A

Hydraulic conserving port associated with the valve inlet.

B

Hydraulic conserving port associated with the valve outlet.

X

Hydraulic conserving port associated with the valve control terminal.

Examples

For an example of using this block, see the “Injection Molding Actuation System” example.

Extended Capabilities

C/C++ Code Generation

Generate C and C++ code using Simulink® Coder™.

See Also

Cartridge Valve Insert | Hydraulic Cartridge Valve Actuator | Poppet Valve

Topics

“Upgrading Simscape Fluids Models Containing Hydraulics (Isothermal) Blocks”

Introduced in R2010a

Hydraulic 4-Port Cartridge Valve Actuator

Double-acting hydraulic valve actuator driven by four pressures

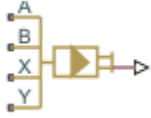

Library

Valve Actuators

Description

The Hydraulic 4-Port Cartridge Valve Actuator block represents a double-acting hydraulic valve actuator driven by four pressures. Use it as a pilot actuator for cartridge valves, pilot-operated pressure and control valves, and similar devices. A schematic diagram of the 4-port cartridge valve actuator is shown in the following illustration.

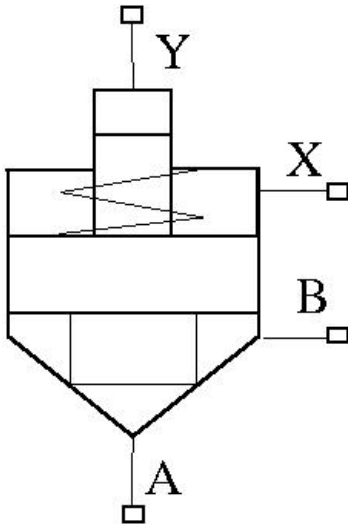

The actuator drives a valve (spool, poppet, and so on) whose position depends on pressures at ports A, B, X, and Y and the spring force. Pressures at ports A and B tend to open the valve, while pressures at control ports X and Y, together with the spring force, act to close it. The model does not account for flow consumption and loading forces, except spring and pressure forces.

Inertial properties of the actuator are accounted for by adding a first order lag between the steady-state and actual valve displacements. The lag is simulated with the combination of the PS Gain and PS Integrator blocks, enveloped by the unity feedback.

The valve remains closed as long as the aggregate pressure force is lower than the spring preload force. The poppet is forced off its seat as the preload force is reached and moves up proportionally to pressure increase until it passes the full stroke.

The force acting on the poppet and the poppet displacement are computed with the following equations:

$$F_P = p_A \cdot A_A + p_B \cdot A_B - p_X \cdot A_X - p_Y \cdot A_Y$$

$$x_S = \begin{cases} 0 & \text{for } F_P \leq F_{PR} \\ (F_P - F_{PR})/k_{spr} & \text{for } F_{PR} < F_P < F_{PR} + k_{spr} \cdot x_{max} \\ x_{max} & \text{for } F_P \geq F_{PR} + k_{spr} \cdot x_{max} \end{cases}$$

$$x = x_S \frac{1}{T_S + 1}$$

where

F_P	Pressure force acting on the poppet
p_A, p_B, p_X, p_Y	Pressures at ports A, B, X, and Y, respectively
A_A, A_B, A_X, A_Y	Areas at ports A, B, X, and Y, respectively. Areas at ports A and Y are block parameters. Area at port X is specified by its ratio to that at port A, A_A / A_X . Area at port B is determined as $A_B = A_X - A_A$.
x	Actual poppet displacement
x_S	Steady-state poppet displacement
x_{max}	Full stroke
F_{PR}	Spring preload force
k_{spr}	Spring rate

Connections A, B, X, and Y are hydraulic conserving ports associated with the actuator ports. Connection P is a physical signal port whose output corresponds to poppet displacement. Pressures applied at ports A and B move the poppet in the positive or negative direction, depending on the value of the **Actuator orientation** parameter. Pressures at ports X and Y act in the opposite direction to pressures at ports A and B.

Basic Assumptions and Limitations

- The flow consumption associated with the valve motion is assumed to be negligible.
- The inertia, friction, and hydraulic axial forces are assumed to be small and are not taken into account.

Parameters

Port A poppet area

Effective poppet area at port A. The parameter value must be greater than zero. The default value is $3.3e-4 \text{ m}^2$.

Port A to port X area ratio

Ratio between poppet areas at port A and port X. The parameter value must be greater than zero. The default value is 0.66 .

Port Y piston area

Effective piston area at port Y. The parameter value must be greater than zero. The default value is $1.65e-4 \text{ m}^2$.

Preload force

Spring preload force. The default value is 26 N.

Spring rate

Spring rate. The default value is $1.4e4 \text{ N/m}$.

Poppet stroke

Maximum poppet stroke. The parameter value must be greater than zero. The default value is $5e-3 \text{ m}$.

Poppet-seat initial gap

Initial gap between the poppet and the seat. The parameter value must be greater than or equal to zero. The default value is 0.

Time constant

Time constant of the first-order lag. The default value is 0.01 s.

Actuator orientation

Specifies actuator orientation with respect to the globally assigned positive direction. The actuator can be installed in two different ways, depending upon whether it moves the poppet in the positive or in the negative direction when pressure is applied at its inlet. If pressures applied at ports A and B move the poppet in the negative direction, set the parameter to `Acts in negative direction`. The default value is `Acts in positive direction`.

Restricted Parameters

When your model is in Restricted editing mode, you cannot modify the following parameter:

- **Actuator orientation**

All other block parameters are available for modification.

Ports

The block has the following ports:

A

Hydraulic conserving port associated with the valve inlet.

B

Hydraulic conserving port associated with the valve outlet.

X

Hydraulic conserving port associated with the valve control terminal.

Y

Hydraulic conserving port associated with the valve control terminal.

P

Physical signal port that outputs poppet displacement.

Examples

For an example of using this block, see the “Injection Molding Actuation System” example.

Extended Capabilities

C/C++ Code Generation

Generate C and C++ code using Simulink® Coder™.

See Also

Hydraulic Cartridge Valve Actuator

Introduced in R2010a

Hydraulic Cartridge Valve Actuator

Double-acting hydraulic actuator for cartridge valves



Library

Valve Actuators

Description

Use the Hydraulic Cartridge Valve Actuator block as a pilot actuator for cartridge valves, as well as pilot-operated pressure and control valves in applications where all the forces, except spring and pressure forces, and flow consumption can be neglected. This block represents a double-acting hydraulic valve actuator driven by three pressures. The actuator drives a valve (spool, poppet, etc.) whose position depends on pressures at ports A, B, and X and the force of the spring. Pressures at ports A and B tend to open the valve, while pressure at control port X together with the spring force act to close it.

Inertial properties of the actuator are accounted for by adding a first order lag between the steady-state and actual valve displacements. The lag is simulated with the combination of the PS Gain and PS Integrator blocks, enveloped by the unity feedback.

The valve remains closed as long as the aggregate pressure force is lower than the spring preload force. The poppet is forced off its seat as the preload force is reached and moves up proportionally to pressure increase until it passes the full stroke.

Connections A, B, and X are hydraulic conserving ports associated with the actuator ports. Connection P is a physical signal port whose output corresponds to poppet displacement. Pressures applied at ports A and B move the poppet in the positive or negative direction, depending on the value of the **Actuator orientation** parameter, with pressure at port X acting in the opposite direction.

Basic Assumptions and Limitations

- The flow consumption associated with the valve motion is assumed to be negligible.
- The inertia, friction, and hydraulic axial forces are assumed to be small and are not taken into account.
- The clearances between the valve and the washers are not taken into account.

Parameters

Port A poppet area

Effective poppet area at port A. The parameter value must be greater than zero. The default value is $3.3e-4 \text{ m}^2$.

Port A to port X area ratio

Ratio between poppet areas at port A and port X. The parameter value must be greater than zero. The default value is 0.66.

Preload force

Spring preload force. The default value is 26 N.

Spring rate

Spring rate. The default value is 1.4e4 N/m.

Poppet stroke

Maximum poppet stroke. The parameter value must be greater than or equal to zero. The default value is 5e-3 m.

Poppet-seat initial gap

Initial gap between the poppet and the seat. The parameter value must be greater than or equal to zero. The default value is 0.

Time constant

Time constant of the first-order lag. The default value is 0.01 s.

Actuator orientation

Specifies actuator orientation with respect to the globally assigned positive direction. The actuator can be installed in two different ways, depending upon whether it moves the poppet in the positive or in the negative direction when pressure is applied at its inlet. If pressures applied at ports A and B move the poppet in the negative direction, set the parameter to `Acts in negative direction`. The default value is `Acts in positive direction`.

Restricted Parameters

When your model is in Restricted editing mode, you cannot modify the following parameter:

- **Actuator orientation**

All other block parameters are available for modification.

Ports

The block has the following ports:

A

Hydraulic conserving port associated with the valve inlet.

B

Hydraulic conserving port associated with the valve outlet.

X

Hydraulic conserving port associated with the valve control terminal.

P

Physical signal port that outputs poppet displacement.

Extended Capabilities

C/C++ Code Generation

Generate C and C++ code using Simulink® Coder™.

See Also

2-Position Valve Actuator | 3-Position Valve Actuator | Cartridge Valve Insert | Hydraulic Double-Acting Valve Actuator | Hydraulic Single-Acting Valve Actuator | Proportional and Servo-Valve Actuator

Introduced in R2008a

Centrifugal Force in Rotating Cylinder

Centrifugal force in rotating hydraulic cylinders



Library

Hydraulic Cylinders

Description

The Centrifugal Force in Rotating Cylinder block is a building block to be used in hydraulic cylinder models, to account for centrifugal forces exerted by fluid on a piston, if the cylinder rotates about its symmetry axis. Such cylinders are used in control mechanisms of various friction clutches, brakes, square-jaw positive clutches, dog clutches, and so on. No inertial effects are considered in the model. In other words, the angular velocity is assumed to be constant or changing at very low speed.

The centrifugal force is computed with the following equation:

$$F = \frac{\pi\rho\omega^2}{4}(r_o^4 - r_i^4 - 2r_p^2(r_o^2 - r_i^2))$$

where

F	Centrifugal force
r_o	Piston outer radius
r_i	Piston inner radius
r_p	Fluid entry radius. For design purposes, $r_p < \sqrt{(r_o^2 + r_i^2)}/2$
ρ	Fluid density
ω	Shaft angular velocity

Connections R and C are mechanical translational conserving ports corresponding to the cylinder rod and case, respectively. Connection W is a physical signal port through which shaft angular velocity is imported. The block directionality is adjustable and can be controlled with the **Cylinder orientation** parameter.

Basic Assumptions and Limitations

- No inertial effects are considered in the model; that is, the angular velocity of the cylinder is assumed to be constant or changing at very low speed.
- Fluid inertia is not taken into account.
- Fluid compressibility is not taken into account.

Parameters

Piston outer radius

The default value is 0.1 m.

Piston inner radius

The default value is 0.05 m.

Fluid entry radius

The default value is 0.06 m.

Fluid density

The default value is 880 kg/m³.

Cylinder orientation

Specifies block orientation with respect to the globally assigned positive direction. The block can be installed in two different ways, depending upon whether it exerts force in the positive or in the negative direction. If positive velocity applied at port W exerts force in negative direction, set the parameter to Acts in negative direction. The default value is Acts in positive direction.

Restricted Parameters

When your model is in Restricted editing mode, you cannot modify the following parameter:

- **Cylinder orientation**

All other block parameters are available for modification.

Examples

The following schematic diagram shows a model of a custom single-acting hydraulic cylinder built of the Single-Acting Hydraulic Cylinder, Rotating Pipe, and Centrifugal Force in Rotating Cylinder blocks.

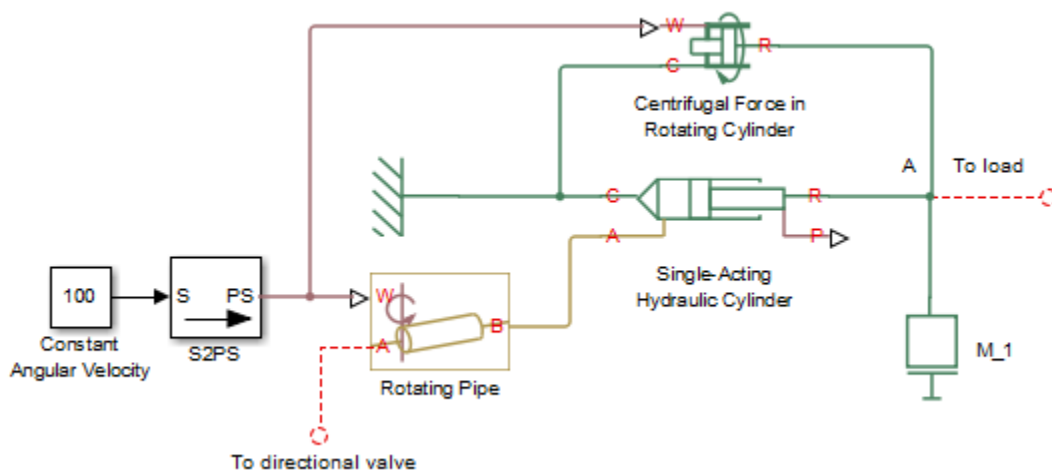

The centrifugal force generated by the Centrifugal Force in Rotating Cylinder block sums up with that of the cylinder at node A. The Rotating Pipe block simulates the pipeline between the cylinder chamber and the channel in the center of a rotating shaft where the cylinder is installed.

Ports

The block has the following ports:

R

Mechanical translational conserving port associated with the cylinder rod.

C

Mechanical translational conserving port associated with the cylinder clamping structure.

W

Physical signal port providing the angular velocity value.

Extended Capabilities

C/C++ Code Generation

Generate C and C++ code using Simulink® Coder™.

See Also

Rotating Pipe

Topics

“Upgrading Simscape Fluids Models Containing Hydraulics (Isothermal) Blocks”

Introduced in R2010a

Centrifugal Pump

Centrifugal pump with choice of parameterization options

Library: Simscape / Fluids / Hydraulics (Isothermal) / Pumps and Motors



Description

The Centrifugal Pump block represents a centrifugal pump of any type as a data-sheet-based model. Depending on data listed in the manufacturer's catalog or data sheet for your particular pump, you can choose one of the following model parameterization options:

- **By approximating polynomial** — Provide values for the polynomial coefficients. These values can be determined analytically or experimentally, depending on the data available. This is the default method.
- **By two 1D characteristics: P-Q and N-Q** — Provide tabulated data of pressure differential P and brake power N versus pump delivery Q characteristics. The pressure differential and brake power are determined by one-dimensional table lookup. You have a choice of two interpolation methods and two extrapolation methods.
- **By two 2D characteristics: P-Q-W and N-Q-W** — Provide tabulated data of pressure differential P and brake power N versus pump delivery Q characteristics at different angular velocities W. The pressure differential and brake power are determined by two-dimensional table lookup. You have a choice of two interpolation methods and two extrapolation methods.

These parameterization options are further described in greater detail:

Connections P and T are hydraulic conserving ports associated with the pump outlet and inlet, respectively. Connection S is a mechanical rotational conserving port associated with the pump driving shaft. The block positive direction is from port T to port P. This means that the pump transfers fluid from T to P as its driving shaft S rotates in the globally assigned positive direction.

Parameterizing the Pump by Approximating Polynomial

If you set the **Model parameterization** parameter to **By approximating polynomial**, the pump is parameterized with the polynomial whose coefficients are determined, analytically or experimentally, for a specific angular velocity depending on the data available. The pump characteristics at other angular velocities are determined using the affinity laws.

The approximating polynomial is derived from the Euler pulse moment equation, Equations 1 and 2, which for a given pump, angular velocity, and fluid can be represented as the following:

$$p_{ref} = k \cdot p_E - p_{HL} - p_D \quad (1-1)$$

where

p_{ref}	Pressure differential across the pump for the reference regime, characterized by the reference angular velocity and density
k	Correction factor. The factor is introduced to account for dimensional fluctuations, blade incongruity, blade volumes, fluid internal friction, and so on. The factor should be set to 1 if the approximating coefficients are determined experimentally.
p_E	Euler pressure
p_{HL}	Pressure loss due to hydraulic losses in the pump passages
p_D	Pressure loss caused by deviations of the pump delivery from its nominal (rated) value

The Euler pressure, p_E , is determined with the Euler equation for centrifugal machines in Equations 1 and 2 based on known pump dimensions. For an existing pump, operating at constant angular velocity and specific fluid, the Euler pressure can be approximated with the equation

$$p_E = \rho_{ref}(c_0 - c_1 \cdot q_{ref})$$

where

ρ_{ref}	Fluid density
c_0, c_1	Approximating coefficients. They can be determined either analytically from the Euler equation (Equations 1 and 2) or experimentally.
q_{ref}	Pump volumetric delivery at reference regime

The pressure loss due to hydraulic losses in the pump passages, p_{HL} , is approximated with the equation

$$p_{HL} = \rho_{ref} \cdot c_2 \cdot q_{ref}^2$$

where

ρ_{ref}	Fluid density
c_2	Approximating coefficient
q_{ref}	Pump volumetric delivery at reference regime

The blade profile is determined for a specific fluid velocity, and deviation from this velocity results in pressure loss due to inconsistency between the fluid velocity and blade profile velocity. This pressure loss, p_D , is estimated with the equation

$$p_D = \rho_{ref} \cdot c_3(q_D - q_{ref})^2$$

where

ρ_{ref}	Fluid density
c_3	Approximating coefficient
q_{ref}	Pump volumetric delivery at reference regime
q_D	Pump design delivery (nominal delivery)

The resulting approximating polynomial takes the form:

$$p_{ref} = \rho_{ref} \left(k(c_0 - c_1 q_{ref}) - c_2 q_{ref}^2 - c_3 (q_D - q_{ref})^2 \right) \quad (1-2)$$

The pump characteristics, approximated with four coefficients c_0 , c_1 , c_2 , and c_3 , are determined for a specific fluid and a specific angular velocity of the pump's driving shaft. These two parameters correspond, respectively, to the **Reference density** and **Reference angular velocity** parameters in the block dialog box. To apply the characteristics for another velocity ω or density ρ , the affinity laws are used. With these laws, the delivery at reference regime, which corresponds to given pump delivery and angular velocity, is computed with the expression

$$q_{ref} = q \frac{\omega_{ref}}{\omega} \quad (1-3)$$

where q and ω are the instantaneous values of the pump delivery and angular velocity. Then the pressure differential p_{ref} at reference regime computed with Equation 2 and converted into pressure differential p at current angular velocity and density

$$p = p_{ref} \cdot \left(\frac{\omega}{\omega_{ref}} \right)^2 \cdot \frac{\rho}{\rho_{ref}}$$

Equation 2 describes pump characteristic for $\omega > 0$ and $q \geq 0$. Outside this range, the characteristic is approximated with the following relationships:

$$p = \begin{cases} -k_{leak} \cdot q & \text{for } \omega \leq 0 \\ p_{max} - k_{leak} \cdot q & \text{for } \omega > 0, q < 0 \\ -k_{leak} \cdot (q - q_{max}) & \text{for } \omega > 0, q > q_{max} \end{cases} \quad (1-4)$$

$$q_{max} = \frac{-b + \sqrt{b^2 + 4ac}}{2a}$$

$$a = (c_2 + c_3) \cdot \alpha^2$$

$$b = (k \cdot c_1 - 2c_3 \cdot q_D) \cdot \alpha$$

$$c = k \cdot c_0 - c_3 \cdot q_D^2$$

$$\alpha = \frac{\omega}{\omega_{ref}}$$

$$q_{max} = \rho \frac{1}{\alpha^2} (k \cdot c_0 - c_3 \cdot q_D^2)$$

where

k_{leak}	Leakage resistance coefficient
q_{max}	Maximum pump delivery at given angular velocity. The delivery is determined from Equation 2 at $p = 0$.
p_{max}	Maximum pump pressure at given angular velocity. The pressure is determined from Equation 2 at $q = 0$.
k	Correction factor, as described in Equation 1.

The hydraulic power at the pump outlet at reference conditions is

$$N_{hyd} = p_{ref} \cdot q_{ref}$$

The output hydraulic power at arbitrary angular velocity and density is determined with the affinity laws

$$N = N_{ref} \left(\frac{\omega}{\omega_{ref}} \right) \cdot \frac{\rho}{\rho_{ref}}$$

The power at the pump driving shaft consists of the theoretical hydraulic power (power before losses associated with hydraulic loss and deviation from the design delivery) and friction loss at the driving shaft. The theoretical hydraulic power is approximated using the Euler pressure

$$N_{hyd0} = p_{Eref} \cdot q_{ref} \cdot \left(\frac{\omega}{\omega_{ref}} \right)^3$$

where

N_{hyd0}	Pump theoretical hydraulic power
p_{Eref}	Euler pressure. The theoretical pressure developed by the pump before losses associated with hydraulic loss and deviation from the design delivery.

The friction losses are approximated with the relationship:

$$N_{fr} = (T_0 + k_p \cdot p) \cdot \omega$$

where

N_{fr}	Friction loss power
T_0	Constant torque at driving shaft associated with shaft bearings, seal friction, and so on
k_p	Torque-pressure relationship, which characterizes the influence of pressure on the driving shaft torque

The power and torque at the pump driving shaft (brake power N_{mech} and brake torque T) are

$$N_{mech} = N_{hyd0} + N_{fr}$$

$$T = \frac{N_{mech}}{\omega}$$

The pump total efficiency η is computed as

$$\eta = \frac{N_{hyd}}{N_{mech}}$$

Parameterizing the Pump by Pressure Differential and Brake Power Versus Pump Delivery

If you set the **Model parameterization** parameter to By two 1D characteristics: P-Q and N-Q, the pump characteristics are computed by using two one-dimensional table lookups: for the pressure differential based on the pump delivery and for the pump brake power based on the pump delivery. Both characteristics are specified at the same angular velocity ω_{ref} (**Reference angular velocity**) and the same fluid density ρ_{ref} (**Reference density**).

To compute pressure differential at another angular velocity, affinity laws are used, similar to the first parameterization option. First, the new reference delivery q_{ref} is computed with the expression

$$q_{ref} = q \frac{\omega_{ref}}{\omega}$$

where q is the current pump delivery. Then the pressure differential across the pump at current angular velocity ω and density ρ is computed as

$$p = p_{ref} \cdot \left(\frac{\omega}{\omega_{ref}} \right)^2 \cdot \frac{\rho}{\rho_{ref}}$$

where p_{ref} is the pressure differential determined from the P-Q characteristic at pump delivery q_{ref} .

Brake power is determined with the equation

$$N = N_{ref} \cdot \left(\frac{\omega}{\omega_{ref}} \right)^3 \cdot \frac{\rho}{\rho_{ref}}$$

where N_{ref} is the reference brake power obtained from the N-Q characteristic at pump delivery q_{ref} .

The torque at the pump driving shaft is computed with the equation $T = N / \omega$.

Parameterizing the Pump by Pressure Differential and Brake Power Versus Pump Delivery at Different Angular Velocities

If you set the **Model parameterization** parameter to By two 2D characteristics: P-Q-W and N-Q-W, the pump characteristics are read out from two two-dimensional table lookups: for the pressure differential based on the pump delivery and angular velocity and for the pump brake power based on the pump delivery and angular velocity.

Both the pressure differential and brake power are scaled if fluid density ρ is different from the reference density ρ_{ref} , at which characteristics have been obtained

$$p = p_{ref} \cdot \frac{\rho}{\rho_{ref}}$$

$$N = N_{ref} \cdot \frac{\rho}{\rho_{ref}}$$

where p_{ref} and N_{ref} are the pressure differential and brake power obtained from the plots.

Basic Assumptions and Limitations

- Fluid compressibility is neglected.
- The pump rotates in positive direction, with speed that is greater or equal to zero.
- The reverse flow through the pump is allowed only at still shaft.

Ports

Conserving

T – Suction port

isothermal liquid

Hydraulic conserving port associated with the pump suction, or inlet.

P – Outlet port

isothermal liquid

Hydraulic conserving port associated with the pump outlet.

S – Shaft port

isothermal liquid

Mechanical rotational conserving port associated with the pump driving shaft.

Parameters**Model parameterization – Model configurations by pressure differential, brake power, and pump capacity**

By approximating polynomial (default) | By two 1D characteristics: P-Q and N-Q | By two 2D characteristics: P-Q-W and N-Q-W

Select one of the following methods for specifying the pump parameters:

- **By approximating polynomial** – Provide values for the polynomial coefficients. These values can be determined analytically or experimentally, depending on the data available. The relationship between pump characteristics and angular velocity is determined from the affinity laws.
- **By two 1D characteristics: P-Q and N-Q** – Provide tabulated data of pressure differential and brake power versus pump delivery characteristics. The pressure differential and brake power are determined by one-dimensional table lookup. You have a choice of two interpolation methods and two extrapolation methods. The relationship between pump characteristics and angular velocity is determined from the affinity laws.
- **By two 2D characteristics: P-Q-W and N-Q-W** – Provide tabulated data of pressure differential and brake power versus pump delivery characteristics at different angular velocities. The pressure differential and brake power are determined by two-dimensional table lookup. You have a choice of two interpolation methods and two extrapolation methods.

First approximating coefficient – Coefficient c_0 of the Euler pulse moment equation for pressure

326.8 Pa/(kg/m³) (default)

Approximating coefficient c_0 in the block description preceding. This parameter is used if **Model parameterization** is set to By approximating polynomial.

Second approximating coefficient – Coefficient c_1 of the Euler pulse moment equation for pressure

3.104e4 Pa*s/kg (default)

Approximating coefficient c_1 in the block description preceding. This parameter is used if **Model parameterization** is set to By approximating polynomial.

Third approximating coefficient – Coefficient c_2 of the hydraulic losses calculation

1.097e7 Pa*s²/(kg*m³) (default)

Approximating coefficient c_2 in the block description preceding. This coefficient accounts for hydraulic losses in the pump. This parameter is used if **Model parameterization** is set to By approximating polynomial.

Fourth approximating coefficient – Coefficient c_3 that accounts for the difference in losses between nominal flow and flow through pump geometry2.136e5 Pa*s²/(kg*m³) (default)

Approximating coefficient c_3 in the block description preceding. This coefficient accounts for additional hydraulic losses caused by deviation from the nominal delivery. This parameter is used if **Model parameterization** is set to By approximating polynomial.

Correction factor – Correction of Euler pressure calculation for reference pressure calculation

0.8 (default)

The factor, denoted as k in the block description preceding, accounts for dimensional fluctuations, blade incongruity, blade volumes, fluid internal friction, and other factors that decrease Euler theoretical pressure. This parameter is used if **Model parameterization** is set to By approximating polynomial.

Pump design delivery – Nominal pump capacity

130 lpm (default)

The pump nominal delivery. The blades profile, pump inlet, and pump outlet are shaped for this particular delivery. Deviation from this delivery causes an increase in hydraulic losses. This parameter is used if **Model parameterization** is set to By approximating polynomial.

Reference angular velocity – Shaft speed

1770 rpm (default)

Angular velocity of the driving shaft, at which the pump characteristics are determined. This parameter is used if **Model parameterization** is set to By approximating polynomial or By two 1D characteristics: P-Q and N-Q.

Reference density – Reference density920 kg/m³ (default)

Fluid density at which the pump characteristics are determined.

Leak resistance – Coefficient for pressure outside of pump normal operating range1e8 Pa/(m³/s) (default)

Leakage resistance coefficient (see Equation 4). This parameter is used if **Model parameterization** is set to By approximating polynomial.

Drive shaft torque – Shaft friction torque

0.1 N*m (default)

The friction torque on the shaft at zero velocity. This parameter is used if **Model parameterization** is set to By approximating polynomial.

Torque-pressure coefficient – Relationship between pump pressure and shaft torque

0.1e-5 N*m/Pa (default)

The coefficient that provides relationship between torque and pump pressure. The default value is 1e-6 N*m/Pa. This parameter is used if **Model parameterization** is set to By approximating polynomial.

Pump delivery vector for Pressure differential – Capacity vector for tabular parameterization of pump pressure

[0, 28, 90, 130, 154, 182] lpm (default)

Specify the vector of pump deliveries, as a one-dimensional array, to be used together with the vector of pressure differentials to specify the P-Q pump characteristic. The vector values must be strictly increasing. The values can be nonuniformly spaced. The minimum number of values depends on the interpolation method: you must provide at least two values for linear interpolation, at least three values for smooth interpolation. This parameter is used if **Model parameterization** is set to By two 1D characteristics: P-Q and N-Q.

Pressure differential across pump vector – Pressure vector for tabular parameterization of pump pressure

[2.6, 2.4, 2, 1.6, 1.2, .8] bar (default)

Specify the vector of pressure differentials across the pump as a one-dimensional array. The vector will be used together with the pump delivery vector to specify the P-Q pump characteristic. The vector must be of the same size as the pump delivery vector for the P-Q table. This parameter is used if **Model parameterization** is set to By two 1D characteristics: P-Q and N-Q.

Pump delivery vector for Brake power – Capacity vector for tabular parameterization of brake power

[0, 20, 40, 60, 80, 100, 120, 140, 160] lpm (default)

Specify the vector of pump deliveries, as a one-dimensional array, to be used together with the vector of the pump brake power to specify the N-Q pump characteristic. The vector values must be strictly increasing. The values can be nonuniformly spaced. The minimum number of values depends on the interpolation method: you must provide at least two values for linear interpolation, at least three values for smooth interpolation. This parameter is used if **Model parameterization** is set to By two 1D characteristics: P-Q and N-Q.

Brake power vector – Brake power vector for tabular parameterization of brake power

[220, 280, 310, 360, 390, 420, 480, 500, 550] W (default)

Specify the vector of pump brake power as a one-dimensional array. The vector will be used together with the pump delivery vector to specify the N-Q pump characteristic. The vector must be of the same size as the pump delivery vector for the N-Q table. This parameter is used if **Model parameterization** is set to By two 1D characteristics: P-Q and N-Q.

Angular velocity vector, w – Shaft speed vector for tabular parameterization of pump pressure

[3200, 3300, 3400, 3500] rpm (default)

Specify the vector of angular velocities, as a one-dimensional array, to be used for calculating both the pump P-Q-W and N-Q-W characteristics. The vector values must be strictly increasing. The values can be nonuniformly spaced. The minimum number of values depends on the interpolation method: you must provide at least two values for linear interpolation, at least three values for smooth interpolation. This parameter is used if **Model parameterization** is set to By two 2D characteristics: P-Q-W and N-Q-W.

Pump delivery vector for Pressure differential, Q_p – Capacity vector for tabular parameterization of pump pressure

[0, 50, 100, 150, 200, 250, 300, 350] lpm (default)

Specify the vector of pump deliveries, as a one-dimensional array, to be used together with the vector of angular velocities and the pressure differential matrix to specify the pump P-Q-W characteristic. The vector values must be strictly increasing. The values can be nonuniformly spaced. The minimum number of values depends on the interpolation method: you must provide at least two values for linear interpolation, at least three values for smooth interpolation. This parameter is used if **Model parameterization** is set to By two 2D characteristics: P-Q-W and N-Q-W.

Pressure differential table, $p(Q_p, \omega)$ – Pressure matrix for tabular parameterization of pump pressure

[8.3, 8.8, 9.3, 9.9; 7.8, 8.3, 8.8, 9.4; 7.2, 7.6, 8.2, 8.7; 6.5, 7, 7.5, 8; 5.6, 6.1, 6.6, 7.1; 4.7, 5.2, 5.7, 6.2; 3.4, 4, 4.4, 4.9; 2.3, 2.7, 3.4, 3.6] bar (default)

Specify the pressure differentials across pump as an m -by- n matrix, where m is the number of the P-Q-W pump delivery values and n is the number of angular velocities. This matrix will define the pump P-Q-W characteristic together with the pump delivery and angular velocity vectors. Each value in the matrix specifies pressure differential for a specific combination of pump delivery and angular velocity. The matrix size must match the dimensions defined by the pump delivery and angular velocity vectors. This parameter is used if **Model parameterization** is set to By two 2D characteristics: P-Q-W and N-Q-W.

Pump delivery vector for Brake power, Q_b – Capacity vector for tabular parameterization of brake power

[0, 50, 100, 150, 200, 250, 300, 350] lpm (default)

Specify the vector of pump deliveries, as a one-dimensional array, to be used together with the vector of angular velocities and the brake power matrix to specify the pump N-Q-W characteristic. The vector values must be strictly increasing. The values can be nonuniformly spaced. The minimum number of values depends on the interpolation method: you must provide at least two values for linear interpolation, at least three values for smooth interpolation. This parameter is used if **Model parameterization** is set to By two 2D characteristics: P-Q-W and N-Q-W.

Brake power table, $W_b(Q_b, \omega)$ – Brake power matrix for tabular parameterization of brake power

[1223, 1341, 1467, 1600; 1414, 1551, 1696, 1850; 1636, 1794, 1962, 2140; 1941, 2129, 2326, 2540; 2224, 2439, 2660, 2910; 2453, 2691, 2947, 3210; 2757, 3024, 3307, 3608; 2945, 3230, 3533, 3854] W (default)

Specify the pump brake power as an m -by- n matrix, where m is the number of the N-Q-W pump delivery values and n is the number of angular velocities. This matrix will define the pump N-Q-W characteristic together with the pump delivery and angular velocity vectors. Each value in the matrix specifies brake power for a specific combination of pump delivery and angular velocity. The matrix size must match the dimensions defined by the pump delivery and angular velocity vectors. This parameter is used if **Model parameterization** is set to By two 2D characteristics: P-Q-W and N-Q-W.

Angular speed threshold for flow reversal – Shaft speed threshold region for flow reversal

1e-9 (default)

Shaft angular velocity that indicates the transition threshold between forward and reverse flow. A transition region is defined around 0 rad/s between the positive and negative values of the angular velocity threshold. Within this transition region, the computed leakage flow rate and friction torque

are adjusted according to the transition term α to ensure smooth transition from one mode to the other.

Interpolation method — Tabular interpolation

Linear (default) | Smooth

Select one of the following interpolation methods for approximating the output value when the input value is between two consecutive grid points:

- **Linear** — Select this option to get the best performance.
- **Smooth** — Select this option to produce a continuous curve or surface with continuous first-order derivatives.

This parameter is used if **Model parameterization** is set to **By two 1D characteristics: P-Q and N-Q** or **By two 2D characteristics: P-Q-W and N-Q-W**. For more information on interpolation algorithms, see the PS Lookup Table (1D) and PS Lookup Table (2D) block reference pages.

Extrapolation method — Tabular extrapolation

Linear (default) | Nearest

Select one of the following extrapolation methods for determining the output value when the input value is outside the range specified in the argument list:

- **Linear** — Select this option to produce a curve or surface with continuous first-order derivatives in the extrapolation region and at the boundary with the interpolation region.
- **Nearest** — Select this option to produce an extrapolation that does not go above the highest point in the data or below the lowest point in the data.

This parameter is used if **Model parameterization** is set to **By two 1D characteristics: P-Q and N-Q** or **By two 2D characteristics: P-Q-W and N-Q-W**. For more information on extrapolation algorithms, see the PS Lookup Table (1D) and PS Lookup Table (2D) block reference pages.

References

[1] T.G. Hicks, T.W. Edwards, *Pump Application Engineering*, McGraw-Hill, NY, 1971

[2] I.J. Karassic, J.P. Messina, P. Cooper, C.C. Heald, *Pump Handbook*, Third edition, McGraw-Hill, NY, 2001

Extended Capabilities

C/C++ Code Generation

Generate C and C++ code using Simulink® Coder™.

See Also

Fixed-Displacement Pump | Variable-Displacement Pressure-Compensated Pump | Variable-Displacement Pump

Topics

“Upgrading Simscape Fluids Models Containing Hydraulics (Isothermal) Blocks”

Introduced in R2007a

Centrifugal Pump (IL)

Centrifugal pump in isothermal liquid network

Library: Simscape / Fluids / Isothermal Liquid / Pumps & Motors

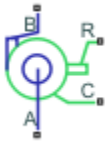

Description

The Centrifugal Pump (IL) block represents a centrifugal pump that transfers energy from the shaft to a fluid in an isothermal liquid network. The pressure differential and mechanical torque are functions of the pump head and brake power, which depend on pump capacity. You can parameterize the pump analytically or by linear interpolation of tabulated data. The pump affinity laws define the core physics of the block, which scale the pump performance to the ratio of the current to the reference values of the pump angular velocity and impeller diameter.

By default, the flow and pressure gain are from port **A** to port **B**. Port **C** represents the pump casing, and port **R** represents the pump shaft. You can specify the normal operating shaft direction in the **Mechanical orientation** parameter. If the shaft begins to spin in the opposite direction, the pressure difference across the block drops to zero.

The figure shows the location of the block ports on a typical centrifugal pump.

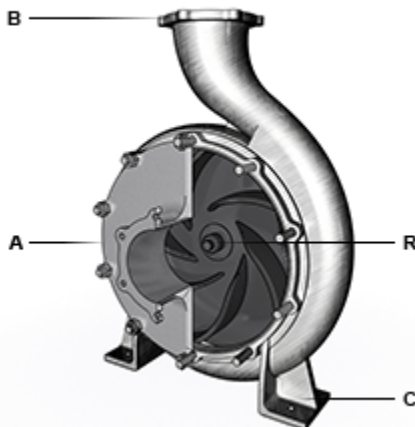

Port Configuration

Analytical Parameterization: Capacity, Head, and Brake Power

When you set, **Pump parameterization** to Capacity, head, and brake power at reference shaft speed, the block calculates the pressure gain over the pump as a function of the pump affinity laws and the reference pressure differential:

$$p_B - p_A = \Delta H_{ref} \rho g \left(\frac{\omega}{\omega_{ref}} \right)^2 \left(\frac{D}{D_{ref}} \right)^2,$$

where:

- g is the gravitational acceleration.
- ΔH is the reference pump head, which the block derives from a quadratic fit of the pump pressure differential between the values of the **Maximum head at zero capacity**, **Nominal head**, and **Maximum capacity at zero head** parameters.
- ω is the shaft angular velocity, $\omega_R - \omega_C$.
- ω_{ref} is the value of the **Reference shaft speed** parameter.
- $\frac{D}{D_{ref}}$ is the value of the **Impeller diameter scale factor** parameter. This block does not reflect changes in pump efficiency due to pump size.
- ρ is the network fluid density.

The shaft torque is:

$$\tau = W_{brake,ref} \frac{\omega^2}{\omega_{ref}^3} \left(\frac{D}{D_{ref}} \right)^5.$$

The reference brake power, $W_{brake,ref}$, is calculated as capacity·head/efficiency. The pump efficiency curve is quadratic with its peak corresponding to the **Nominal brake power** parameter, and it falls to zero when capacity is zero or maximum as the pump curve figure demonstrates.

The block calculates the reference capacity as:

$$q_{ref} = \frac{\dot{m}}{\rho} \frac{\omega_{ref}}{\omega} \left(\frac{D_{ref}}{D} \right)^3.$$

You can choose to be warned when the block flow rate becomes negative or exceeds the maximum pump capacity by setting **Check if operating beyond normal pump operation** to 0n.

1-D Tabulated Data Parameterization: Head and Brake Power as a Function of Capacity

When you set **Pump parameterization** to 1D tabulated data - head and brake power vs. capacity at reference shaft speed, the pressure gain over the pump functions with the **Reference head vector** parameter, ΔH_{ref} , which is a function of the reference capacity, q_{ref} :

$$\Delta p = \rho g \Delta H_{ref}(q_{ref}) \left(\frac{\omega}{\omega_{ref}} \right)^2 \left(\frac{D}{D_{ref}} \right)^2,$$

where g is the gravitational acceleration.

The block bases the shaft torque on the **Reference brake power vector** parameter, W_{ref} , which is a function of the reference capacity:

$$\tau = W_{ref}(q_{ref}) \frac{\omega^2}{\omega_{ref}^3} \left(\frac{\rho}{\rho_{ref}} \right) \left(\frac{D}{D_{ref}} \right)^5,$$

where ρ_{ref} is the **Reference density** parameter. The reference capacity is:

$$q_{ref} = \frac{\dot{m}}{\rho} \left(\frac{\omega_{ref}}{\omega} \right) \left(\frac{D_{ref}}{D} \right)^3,$$

which the block uses to interpolate the values of the **Reference capacity vector**, **Reference head vector**, and **Reference brake power vector** parameters as a function of q_{ref} .

When the simulation is outside of the normal pump operating conditions, the block extrapolates the pump head linearly and brake power to the nearest point.

2-D Tabulated Data Parameterization: Head and Brake Power as a Function of Capacity and Shaft Speed

When you set **Pump parameterization** to 2D tabulated data - head and brake power vs. capacity and shaft speed, the pressure gain over the pump is a function of the **Head table**, **H(q,w)** parameter, ΔH_{ref} , which is a function of the reference capacity, q_{ref} , and the shaft speed, ω :

$$\Delta p = \rho g \Delta H_{ref}(q_{ref}, \omega) \left(\frac{D}{D_{ref}} \right)^2.$$

The shaft torque is a function of the **Brake power table**, **Wb(q,w)** parameter, W_{ref} , which is a function of the reference capacity, q_{ref} , and the shaft speed, ω :

$$\tau = \frac{W_{ref}(q_{ref}, \omega)}{\omega} \left(\frac{\rho}{\rho_{ref}} \right) \left(\frac{D}{D_{ref}} \right)^5.$$

The reference capacity is:

$$q_{ref} = \frac{\dot{m}}{\rho} \left(\frac{D_{ref}}{D} \right)^3.$$

When the simulation is outside of the normal pump operating conditions, the block extrapolates the pump head linearly and brake power to the nearest point.

Visualizing the Pump Curve

You can check the parameterized pump performance by plotting the head, power, efficiency, and torque as a function of the flow. To generate a plot of the current pump settings, right-click on the block and select **Fluids > Plot Pump Characteristics**. If you change settings or data, click **Apply** on the block parameters and click **Reload Data** on the pump curve figure.

The default block parameterization results in these plots:

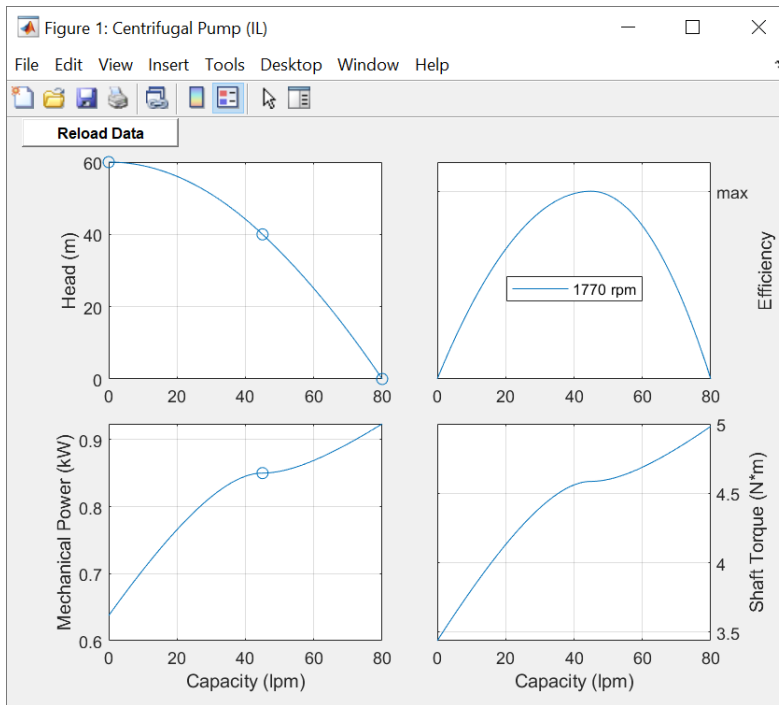

Predefined Parameterization

You can model a specific supplier component by pre-parameterizing the Centrifugal Pump (IL) block with manufacturer data.

To load a predefined parameterization:

- 1 Double-click the block. Click the **Select a predefined parameterization** hyperlink in the Centrifugal Pump (IL) block dialog description.
- 2 Select a part from the **Select manufacturer** and **Select part** drop-down menus, then click **Update block with selected part**.
- 3 You can compare your current settings with a specific component by clicking **Compare block settings with selected part**. The differences between the current settings and the pre-defined parameterization display in the MATLAB Command Window.

Assumptions and Limitations

- Reverse flow or a pressure drop over the pump is not normal operation, and the simulation results in these situations may not be accurate.
- The block does not account for dynamic pressure in the pump. The block only considers pump head due to static pressure.
- Pre-defined parameterizations use available data and the block fills in missing data where necessary. Validate your model against expected results.

Ports

Conserving

A – Pump inlet

isothermal liquid

Isothermal liquid conserving port associated with the fluid inlet.

B – Pump outlet

isothermal liquid

Thermal liquid conserving port associated with the fluid outlet.

R – Impeller shaft

mechanical rotational

Mechanical rotational conserving port associated with the shaft.

C – Pump casing

mechanical rotational

Mechanical rotational conserving port associated with the case.

Parameters

Pump parameterization – Head and brake power parameterization

Capacity, head, and brake power at reference shaft speed (default) | 1D tabulated data - head and brake power vs. capacity at reference shaft speed | 2D tabulated data - head and brake power vs. capacity and shaft speed

Parameterization of the pump head and brake power.

- Capacity, head, and brake power at reference shaft speed: Parameterize pump pressure gain and shaft torque with an analytical formula.
- 1D tabulated data - head and brake power vs. capacity at reference shaft speed: Parameterize head and brake power from tabulated data of the head and brake power at a given capacity.
- 2D tabulated data - head and brake power vs. capacity and shaft speed: Parameterize head and brake power from tabulated data of the head and brake power at a given capacity and shaft speed.

Nominal capacity – Pump volumetric flow rate

45 lpm (default) | positive scalar

Nominal pump volumetric flow rate at a reference shaft angular velocity.

Dependencies

To enable this parameter, set **Pump parameterization** to Capacity, head, and brake power at reference shaft speed.

Nominal head – Pump head

40 m (default) | positive scalar

Nominal pump pressure differential, normalized by gravity and the fluid density, at a reference shaft angular velocity.

Dependencies

To enable this parameter, set **Pump parameterization** to Capacity, head, and brake power at reference shaft speed.

Nominal brake power — Pump power

0.85 kW (default) | positive scalar

Nominal mechanical shaft power at a reference angular velocity.

Dependencies

To enable this parameter, set **Pump parameterization** to Capacity, head, and brake power at reference shaft speed.

Maximum head at zero capacity — Maximum pump head with no flow

60 m (default) | positive scalar

Maximum pump head with no flow at a reference angular velocity. This parameter determines the reference pressure differential over the pump, which it uses to fit a quadratic equation for pressure in addition to the **Nominal capacity**, **Nominal head**, and **Maximum capacity at zero head** parameters.

Dependencies

To enable this parameter, set **Pump parameterization** to Capacity, head, and brake power at reference shaft speed.

Maximum capacity at zero head — Maximum flow rate with zero head

80 lpm (default) | positive scalar

Maximum fluid load with zero head at a reference angular velocity. This parameter determines the reference pressure differential over the pump, which it uses to fit a quadratic equation for pressure in addition to the **Nominal capacity**, **Nominal head**, and **Maximum head at zero capacity** parameters.

Dependencies

To enable this parameter, set **Pump parameterization** to Capacity, head, and brake power at reference shaft speed.

Reference shaft speed — Reference shaft angular velocity for affinity law calculations

1770 rpm | 3500 rpm | positive scalar

Reference angular velocity for affinity law calculations. The default value depends on the **Pump parameterization** setting.

Dependencies

To enable this parameter, set **Pump parameterization** to either:

- Capacity, head, and brake power at reference shaft speed.
- 1D tabulated data - head and brake power vs. capacity at reference shaft speed.

Reference capacity vector – Volumetric flow rate

[16.67, 30, 40, 53.33, 66.67, 83.33] lpm (default) | vector

Nonnegative vector of volumetric flow rates for the tabular parameterization of pump head or brake power. The elements in this vector correspond one-to-one with the elements in the **Reference head vector** and **Reference brake power vector** parameters.

Dependencies

To enable this parameter, set **Pump parameterization** to 1D tabulated data - head and brake power vs. capacity at reference shaft speed.

Reference head vector – Pump head vector

[50, 47.5, 45, 40, 35, 25] m (default) | vector

Nonnegative vector of pump head values for the 1-D tabular parameterization of pump head and brake power. This parameter corresponds one-to-one with the **Reference capacity vector** parameter

Dependencies

To enable this parameter, set **Pump parameterization** to 1D tabulated data - head and brake power vs. capacity at reference shaft speed.

Reference brake power vector – Pump brake power vector

[.6, .75, .85, .93, .98, .99] kW (default) | vector

Nonnegative vector of pump brake power values for the 1-D tabular parameterization of pump head and brake power. This parameter corresponds one-to-one with the **Reference capacity vector** parameter

Dependencies

To enable this parameter, set **Pump parameterization** to 1D tabulated data - head and brake power vs. capacity at reference shaft speed.

Capacity vector, q – Volumetric displacement vector

[16.67, 23.33, 30, 40, 53.33, 60] lpm (default) | vector

Vector of volumetric flow rates for the tabular parameterization of pump head. This vector forms an independent axis with the **Shaft speed vector, w** parameter for the 2-D **Head table, H(q,w)** and **Brake power table, Wb(q,w)** parameters. The vector elements must be listed in ascending order and must be greater than or equal to 0.

Dependencies

To enable this parameter, set **Pump parameterization** to 2D tabulated data - head and brake power vs. capacity and shaft speed.

Shaft speed vector, w – Angular velocity vector

[2450, 2800, 3150, 3500] rpm (default) | vector

Vector of shaft angular velocity values for the tabular parameterization of pump head. This vector forms an independent axis with the **Capacity vector, q** parameter for the 2-D **Head table, H(q,w)** and **Brake power table, Wb(q,w)** parameters. The vector elements must be listed in ascending order and must be greater than 0.

Dependencies

To enable this parameter, set **Pump parameterization** to 2D tabulated data - head and brake power vs. capacity and shaft speed.

Head table, $H(q,w)$ – Pump head matrix

[25, 32.7, 42.5, 50; 24, 31.7, 41, 49; 22.7, 30.5, 39, 47.5; 20, 28, 36, 45; 15.7, 24, 32, 40; 12.5, 21, 29.5, 37.5] m (default) | M -by- N matrix

M -by- N matrix of pump head values at the specified volumetric flow rate and angular velocity. All table elements must be greater than or equal to 0. The block employs linear interpolation between table elements. M and N are the sizes of the corresponding vectors:

- M is the number of elements in the **Capacity vector, q** parameter.
- N is the number of elements in the **Shaft speed vector, w** parameter. All rows must be in strictly ascending order.

Dependencies

To enable this parameter, set **Pump parameterization** to 2D tabulated data - head and brake power vs. capacity and shaft speed.

Brake power table, $W_b(q,w)$ – Pump brake power matrix

[.28, .38, .5, .6; .31, .41, .55, .68; .33, .44, .6, .75; .36, .48, .65, .83; .38, .53, .72, .93; .39, .55, .75, .97] kW (default) | M -by- N matrix

M -by- N matrix of pump brake power values at the specified volumetric flow rate and angular velocity. All values must be greater than 0. Linear interpolation is employed between table elements. M and N are the sizes of the corresponding vectors:

- M is the number of vector elements in the **Capacity vector, q** parameter.
- N is the number of vector elements in the **Shaft speed vector, w** parameter. All rows must be in strictly ascending order.

Dependencies

To enable this parameter, set **Pump parameterization** to 2D tabulated data - head and brake power vs. capacity and shaft speed.

Reference density – Fluid density for given pump performance data

998 kg/m³ (default) | positive scalar

Fluid density specified by the reference or data sheet performance. This parameter scales the pump performance between different fluids.

Impeller diameter scale factor – Ratio of model diameter to reference diameter for affinity law calculations

1 (default) | positive scalar

Ratio of the model diameter to reference diameter for affinity law calculations. Modify this value if there is a difference between your reference and the system impeller diameters, such as when testing pump scaling. For system pumps smaller than the reference pump, use a value less than one. For system pumps larger than the reference pump, use a value greater than one. The block does not reflect changes in pump efficiency due to pump size.

Mechanical orientation — Shaft normal rotational direction

Positive angular velocity of port R relative to port C corresponds to normal pump operation (default) | Negative angular velocity of port R relative to port C corresponds to normal pump operation

Shaft rotational direction for flow from port **A** to **B**.

Check if operating beyond normal pump operation — Option to notify when block is beyond operating bounds

Warning (default) | None | Error

Option to notify if the block operates outside of the normal pump boundary. This occurs when the flow rate through the pump is negative or beyond the maximum capacity of the pump.

Dependencies

To enable this parameter, set **Pump parameterization** to Capacity, head, and brake power at reference shaft speed.

See Also

Centrifugal Pump (TL) | Variable-Displacement Pump (IL) | Pressure-Compensated Pump (IL) | Fixed-Displacement Pump (IL)

Topics

Introduced in R2020a

Centrifugal Pump (TL)

Centrifugal pump in thermal liquid network

Library: Simscape / Fluids / Thermal Liquid / Pumps & Motors



Description

The Centrifugal Pump (TL) block represents a centrifugal pump that transfers energy from the shaft to a fluid in a thermal liquid network. The pressure differential and mechanical torque are functions of the pump head and brake power, which depend on pump capacity. You can parameterize the pump analytically or by linear interpolation of tabulated data. The pump affinity laws define the core physics of the block, which scale the pump performance to the ratio of the current to the reference values of the pump angular velocity and impeller diameter.

By default, the flow and pressure gain are from port **A** to port **B**. Port **C** represents the pump casing, and port **R** represents the pump shaft. You can specify the normal operating shaft direction in the **Mechanical orientation** parameter. If the shaft begins to spin in the opposite direction, the pressure difference across the pump drops to zero.

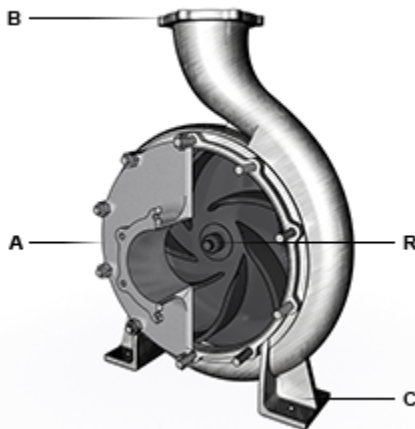

Port Configuration

Analytical Parameterization: Capacity, Head, and Brake Power

The block calculates the pressure gain over the pump as a function of the pump affinity laws and the reference pressure differential:

$$p_B - p_A = \Delta H_{ref} \rho g \left(\frac{\omega}{\omega_{ref}} \right)^2 \left(\frac{D}{D_{ref}} \right)^2,$$

where:

- Δp_{ref} is the reference pressure gain, which is determined from a quadratic fit of the pump pressure differential between the **Maximum head at zero capacity**, **Nominal head**, and **Maximum capacity at zero head**.
- ω is the shaft angular velocity, $\omega_R - \omega_C$.
- ω_{ref} is the value of the **Reference shaft speed** parameter.
- $\frac{D}{D_{ref}}$ is the value of the **Impeller diameter scale factor** parameter. This block does not reflect changes in pump efficiency due to pump size.
- ρ is the network fluid density.

The shaft torque is:

$$\tau = W_{brake,ref} \frac{\omega^2}{\omega_{ref}^3} \left(\frac{D}{D_{ref}} \right)^5.$$

The reference brake power, $W_{brake,ref}$, is calculated as capacity·head/efficiency. The pump efficiency curve is quadratic with its peak corresponding to the **Nominal brake power** parameter, and it falls to zero when capacity is zero or maximum as the pump curve demonstrates.

The block calculates the reference capacity as:

$$q_{ref} = \frac{\dot{m}}{\rho} \frac{\omega_{ref}}{\omega} \left(\frac{D_{ref}}{D} \right)^3.$$

1-D Tabulated Data Parameterization: Head and Brake Power as a Function of Capacity

You can parameterize the pump performance as a 1-D function of capacity. The pressure gain over the pump functions with the **Reference head vector** parameter, ΔH_{ref} , which is a function of the reference capacity, Q_{ref} :

$$\Delta p = \rho g \Delta H_{ref}(Q_{ref}) \frac{\omega^2}{\omega_{ref}^2} \left(\frac{D}{D_{ref}} \right)^2,$$

where:

- ω is the shaft angular velocity.
- ρ is the fluid density.
- g is the gravitational acceleration.

This is derived from the affinity law that relates head and angular velocity:

$$\frac{\Delta H_{ref}}{\Delta H} = \frac{\omega_{ref}^2}{\omega^2} \left(\frac{D}{D_{ref}} \right)^2,$$

where ΔH is the pump head.

The block bases the shaft torque on the **Reference brake power vector** parameter, P_{ref} , which is a function of the reference capacity, Q_{ref} .

$$T = P_{ref}(Q_{ref}) \frac{\omega^2}{\omega_{ref}^3} \frac{\rho}{\rho_{ref}} \left(\frac{D}{D_{ref}} \right)^5,$$

where ρ_{ref} is the **Reference density** parameter.

This equation is a formulation of the affinity law that relates brake power and angular velocity:

$$\frac{P_{ref}}{P} = \frac{\omega_{ref}^3}{\omega^3} \frac{\rho_{ref}}{\rho} \left(\frac{D}{D_{ref}} \right)^5.$$

The reference capacity is:

$$Q_{ref} = \frac{\dot{m}}{\rho} \frac{\omega_{ref}}{\omega} \left(\frac{D}{D_{ref}} \right)^3,$$

where \dot{m} is the mass flow rate at the pump inlet.

When the simulation is outside of the normal pump operating conditions, the block extrapolates the pump head linearly and brake power to the nearest point.

2-D Tabulated Data Parameterization: Head and Brake Power as a Function of Capacity and Shaft Speed

You can parameterize the pump performance as a 2-D function of capacity and shaft angular velocity. The pressure gain over the pump is a function of the **Head table, $\mathbf{H}(\mathbf{Q}, \mathbf{w})$** parameter, ΔH_{ref} , which is a function of the reference capacity, Q_{ref} , and the shaft speed, ω :

$$\Delta p = \rho g \Delta H_{ref}(Q_{ref}, \omega) \left(\frac{D}{D_{ref}} \right)^2.$$

The shaft torque is a function of the **Brake power table, $\mathbf{Wb}(\mathbf{q}, \mathbf{w})$** parameter, P_{ref} , which is a function of the reference capacity, Q_{ref} , and the shaft speed, ω :

$$T = \frac{P_{ref}(Q_{ref}, \omega)}{\omega} \frac{\rho}{\rho_{ref}} \left(\frac{D}{D_{ref}} \right)^5.$$

The reference capacity is:

$$Q_{ref} = \frac{\dot{m}}{\rho} \left(\frac{D_{ref}}{D} \right)^3.$$

When the simulation is outside of the normal pump operating conditions, the block extrapolates the pump head linearly and brake power to the nearest point.

Visualizing the Pump Curve

You can check the parameterized pump performance by plotting the head, power, efficiency, and torque as a function of the flow. To generate a plot of the current pump settings, right-click on the block and select **Fluids > Plot Pump Characteristics**. If you change settings or data, click **Apply** on the block parameters and click **Reload Data** on the pump curve figure.

The default block parameterization results in these plots:

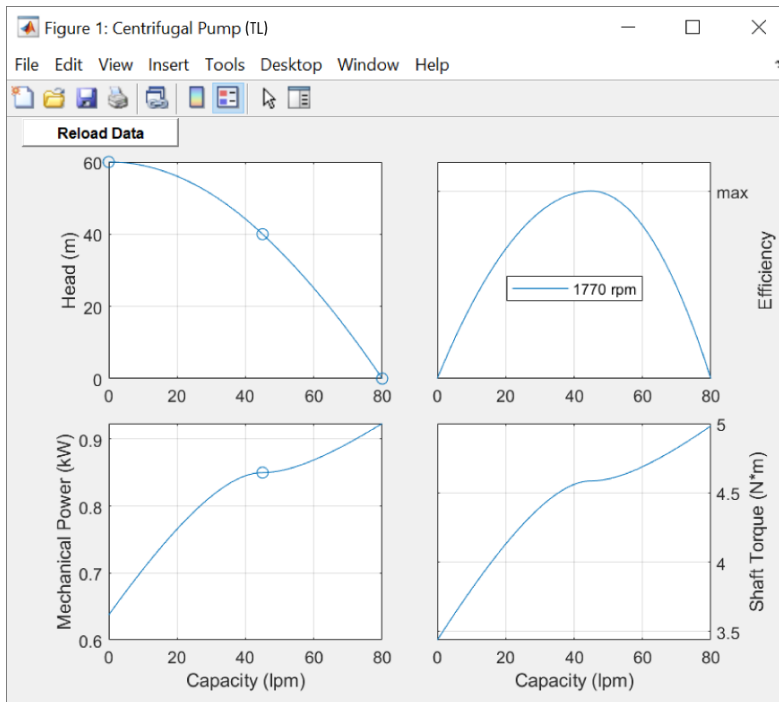

Energy Balance

Mechanical work is a result of the energy exchange from the shaft to the fluid. The governing energy balance equation is:

$$\phi_A + \phi_B + P_{hydro} = 0,$$

where:

- Φ_A is the energy flow rate at port **A**.
- Φ_B is the energy flow rate at port **B**.

The pump hydraulic power is a function of the pressure difference between pump ports:

$$P_{hydro} = \Delta p \frac{\dot{m}}{\rho}.$$

Assumptions and Limitations

- Reverse flow or a pressure drop over the pump is not normal operation, and the simulation results in these situations may not be accurate.
- The block does not account for dynamic pressure in the pump. The block only considers pump head due to static pressure.

Ports

Conserving

A — Pump inlet

thermal liquid

Thermal liquid conserving port associated with the fluid.

B – Pump outlet

thermal liquid

Thermal liquid conserving port associated with the fluid.

R – Impeller shaft

mechanical rotational

Mechanical rotational conserving port associated with the shaft.

C – Pump casing

mechanical rotational

Mechanical rotational conserving port associated with the case.

Parameters

Pump parameterization – Head and brake power parameterization

Capacity, head, and brake power at reference shaft speed (default) | 1D tabulated data - head and brake power vs. capacity at reference shaft speed | 2D tabulated data - head and brake power vs. capacity and shaft speed

Parameterization of the pump head and brake power.

- Capacity, head, and brake power at reference shaft speed: Parameterize pump pressure gain and shaft torque with an analytical formula.
- 1D tabulated data - head and brake power vs. capacity at reference shaft speed: Parameterize head and brake power from tabulated data of the head and brake power at a given capacity.
- 2D tabulated data - head and brake power vs. capacity and shaft speed: Parameterize head and brake power from tabulated data of the head and brake power at a given capacity and shaft speed.

Nominal capacity – Pump volumetric flow rate

45 lpm (default) | positive scalar

Nominal pump volumetric flow rate at a reference shaft angular velocity.

Dependencies

To enable this parameter, set **Pump parameterization** to Capacity, head, and brake power at reference shaft speed.

Nominal head – Pump head

40 m (default) | positive scalar

Nominal pump pressure differential, normalized by gravity and the fluid density, at a reference shaft angular velocity.

Dependencies

To enable this parameter, set **Pump parameterization** to Capacity, head, and brake power at reference shaft speed.

Nominal brake power — Pump power

0.85 kW (default) | positive scalar

Nominal mechanical shaft power at a reference angular velocity.

Dependencies

To enable this parameter, set **Pump parameterization** to Capacity, head, and brake power at reference shaft speed.

Maximum head at zero capacity — Maximum pump head with no flow

60 m (default) | positive scalar

Maximum pump head with no flow at a reference angular velocity. This parameter determines the reference pressure differential over the pump, which it uses to fit a quadratic equation for pressure in addition to the **Nominal capacity**, **Nominal head**, and **Maximum capacity at zero head** parameters.

Dependencies

To enable this parameter, set **Pump parameterization** to Capacity, head, and brake power at reference shaft speed.

Maximum capacity at zero head — Maximum flow rate with zero head

80 lpm (default) | positive scalar

Maximum fluid load with zero head at a reference angular velocity. This parameter determines the reference pressure differential over the pump, which it uses to fit a quadratic equation for pressure in addition to the **Nominal capacity**, **Nominal head**, and **Maximum head at zero capacity** parameters.

Dependencies

To enable this parameter, set **Pump parameterization** to Capacity, head, and brake power at reference shaft speed.

Reference shaft speed — Reference shaft angular velocity for affinity law calculations

1770 rpm | 3500 rpm | positive scalar

Reference angular velocity for affinity law calculations. The default value depends on the **Pump parameterization** setting.

Dependencies

To enable this parameter, set **Pump parameterization** to either:

- Capacity, head, and brake power at reference shaft speed.
- 1D tabulated data - head and brake power vs. capacity at reference shaft speed.

Reference capacity vector — Volumetric flow rate

[16.67, 30, 40, 53.33, 66.67, 83.33] lpm (default) | vector

Nonnegative vector of volumetric flow rates for the tabular parameterization of pump head or brake power. The elements in this vector correspond one-to-one with the elements in the **Reference head vector** and **Reference brake power vector** parameters.

Dependencies

To enable this parameter, set **Pump parameterization** to 1D tabulated data - head and brake power vs. capacity at reference shaft speed.

Reference head vector – Pump head vector

[50, 47.5, 45, 40, 35, 25] m (default) | vector

Nonnegative vector of pump head values for the 1-D tabular parameterization of pump head and brake power. This parameter corresponds one-to-one with the **Reference capacity vector** parameter

Dependencies

To enable this parameter, set **Pump parameterization** to 1D tabulated data - head and brake power vs. capacity at reference shaft speed.

Reference brake power vector – Pump brake power vector

[.6, .75, .85, .93, .98, .99] kW (default) | vector

Nonnegative vector of pump brake power values for the 1-D tabular parameterization of pump head and brake power. This parameter corresponds one-to-one with the **Reference capacity vector** parameter

Dependencies

To enable this parameter, set **Pump parameterization** to 1D tabulated data - head and brake power vs. capacity at reference shaft speed.

Capacity vector, q – Volumetric displacement vector

[16.67, 23.33, 30, 40, 53.33, 60] lpm (default) | vector

Vector of volumetric flow rates for the tabular parameterization of pump head. This vector forms an independent axis with the **Shaft speed vector, w** parameter for the 2-D **Head table, $H(q,w)$** and **Brake power table, $Wb(q,w)$** parameters. The vector elements must be listed in ascending order and must be greater than or equal to 0.

Dependencies

To enable this parameter, set **Pump parameterization** to 2D tabulated data - head and brake power vs. capacity and shaft speed.

Shaft speed vector, w – Angular velocity vector

[2450, 2800, 3150, 3500] rpm (default) | vector

Vector of shaft angular velocity values for the tabular parameterization of pump head. This vector forms an independent axis with the **Capacity vector, q** parameter for the 2-D **Head table, $H(q,w)$** and **Brake power table, $Wb(q,w)$** parameters. The vector elements must be listed in ascending order and must be greater than 0.

Dependencies

To enable this parameter, set **Pump parameterization** to 2D tabulated data - head and brake power vs. capacity and shaft speed.

Head table, $H(q,w)$ – Pump head matrix

[25, 32.7, 42.5, 50; 24, 31.7, 41, 49; 22.7, 30.5, 39, 47.5; 20, 28, 36, 45; 15.7, 24, 32, 40; 12.5, 21, 29.5, 37.5] m (default) | M -by- N matrix

M -by- N matrix of pump head values at the specified volumetric flow rate and angular velocity. All table elements must be greater than or equal to 0. The block employs linear interpolation between table elements. M and N are the sizes of the corresponding vectors:

- M is the number of elements in the **Capacity vector, q** parameter.
- N is the number of elements in the **Shaft speed vector, w** parameter. All rows must be in strictly ascending order.

Dependencies

To enable this parameter, set **Pump parameterization** to 2D tabulated data - head and brake power vs. capacity and shaft speed.

Brake power table, $W_b(q,w)$ — Pump brake power matrix

[.28, .38, .5, .6; .31, .41, .55, .68; .33, .44, .6, .75; .36, .48, .65, .83; .38, .53, .72, .93; .39, .55, .75, .97] kW (default) | M -by- N matrix

M -by- N matrix of pump brake power values at the specified volumetric flow rate and angular velocity. All values must be greater than 0. Linear interpolation is employed between table elements. M and N are the sizes of the corresponding vectors:

- M is the number of vector elements in the **Capacity vector, q** parameter.
- N is the number of vector elements in the **Shaft speed vector, w** parameter. All rows must be in strictly ascending order.

Dependencies

To enable this parameter, set **Pump parameterization** to 2D tabulated data - head and brake power vs. capacity and shaft speed.

Reference density — Fluid density for given pump performance data

998 kg/m³ (default) | positive scalar

Fluid density specified by the reference or data sheet performance. This parameter scales the pump performance between different fluids.

Impeller diameter scale factor — Ratio of model diameter to reference diameter for affinity law calculations

1 (default) | positive scalar

Ratio of the model diameter to reference diameter for affinity law calculations. Modify this value if there is a difference between your reference and the system impeller diameters, such as when testing pump scaling. For system pumps smaller than the reference pump, use a value less than one. For system pumps larger than the reference pump, use a value greater than one. The block does not reflect changes in pump efficiency due to pump size.

Mechanical orientation — Shaft normal rotational direction

Positive angular velocity of port R relative to port C corresponds to normal pump operation (default) | Negative angular velocity of port R relative to port C corresponds to normal pump operation

Shaft rotational direction for flow from port **A** to **B**.

Check if operating beyond normal pump operation – Option to notify when block is beyond operating bounds

Warning (default) | None | Error

Option to notify if the block operates outside of the normal pump boundary. This occurs when the flow rate through the pump is negative or beyond the maximum capacity of the pump.

Dependencies

To enable this parameter, set **Pump parameterization** to Capacity, head, and brake power at reference shaft speed.

Extended Capabilities**C/C++ Code Generation**

Generate C and C++ code using Simulink® Coder™.

See Also

Centrifugal Pump (IL) | Fixed-Displacement Pump (TL) | Variable-Displacement Pump (TL)

Topics**Introduced in R2018a**

Check Valve

Hydraulic valve that allows flow in one direction only



Library

Directional Valves

Description

The Check Valve block represents a hydraulic check valve as a data-sheet-based model. The purpose of the check valve is to permit flow in one direction and block it in the opposite direction. The following figure shows the typical dependency between the valve passage area A and the pressure differential across the valve $\Delta p = p_A - p_B$.

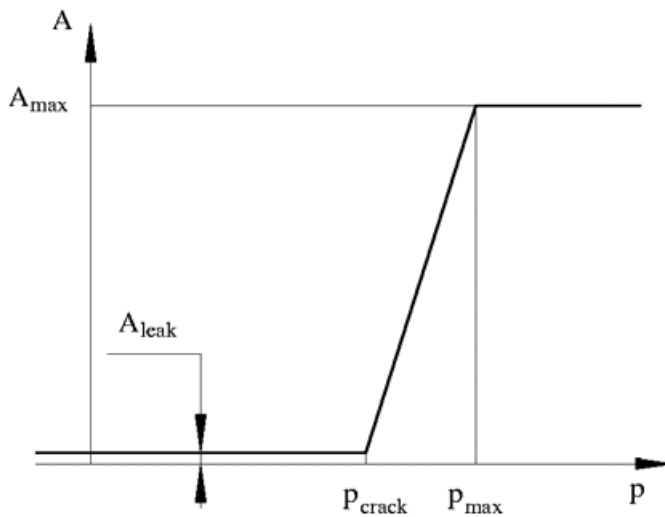

The valve remains closed while pressure differential across the valve is lower than the valve cracking pressure. When cracking pressure is reached, the valve control member (spool, ball, poppet, etc.) is forced off its seat, thus creating a passage between the inlet and outlet. If the flow rate is high enough and pressure continues to rise, the area is further increased until the control member reaches its maximum. At this moment, the valve passage area is at its maximum. The valve maximum area and the cracking and maximum pressures are generally provided in the catalogs and are the three key parameters of the block.

In addition to the maximum area, the leakage area is also required to characterize the valve. The main purpose of the parameter is not to account for possible leakage, even though this is also important, but to maintain numerical integrity of the circuit by preventing a portion of the system from getting isolated after the valve is completely closed. An isolated or “hanging” part of the system

could affect computational efficiency and even cause failure of computation. Therefore, the parameter value must be greater than zero.

By default, the block does not include valve opening dynamics, and the valve sets its opening area directly as a function of pressure:

$$A = A(p)$$

Adding valve opening dynamics provides continuous behavior that is more physically realistic, and is particularly helpful in situations with rapid valve opening and closing. The pressure-dependent orifice passage area $A(p)$ in the block equations then becomes the steady-state area, and the instantaneous orifice passage area in the flow equation is determined as follows:

$$A(t = 0) = A_{init}$$

$$\frac{dA}{dt} = \frac{A(p) - A}{\tau}$$

In either case, the flow rate through the valve is determined according to the following equations:

$$q = C_D \cdot A \sqrt{\frac{2}{\rho}} \cdot \frac{p}{(p^2 + p_{cr}^2)^{1/4}}$$

$$A(p) = \begin{cases} A_{leak} & \text{for } p \leq p_{crack} \\ A_{leak} + k \cdot (p - p_{crack}) & \text{for } p_{crack} < p < p_{max} \\ A_{max} & \text{for } p \geq p_{max} \end{cases}$$

$$k = \frac{A_{max} - A_{leak}}{p_{max} - p_{crack}}$$

$$\Delta p = p_A - p_B,$$

$$p_{cr} = \frac{\rho}{2} \left(\frac{Re_{cr} \cdot \nu}{C_D \cdot D_H} \right)^2$$

$$D_H = \sqrt{\frac{4A}{\pi}}$$

where

q	Flow rate
p	Pressure differential
p_A, p_B	Gauge pressures at the block terminals
C_D	Flow discharge coefficient
A	Instantaneous orifice passage area
$A(p)$	Pressure-dependent orifice passage area
A_{init}	Initial open area of the valve
A_{max}	Fully open valve passage area
A_{leak}	Closed valve leakage area

p_{crack}	Valve cracking pressure
p_{max}	Pressure needed to fully open the valve
p_{cr}	Minimum pressure for turbulent flow
Re_{cr}	Critical Reynolds number
D_{H}	Instantaneous orifice hydraulic diameter
ρ	Fluid density
ν	Fluid kinematic viscosity
τ	Time constant for the first order response of the valve opening
t	Time

The block positive direction is from port A to port B. This means that the flow rate is positive if it flows from A to B, and the pressure differential is determined as $\Delta p = p_A - p_B$.

Basic Assumptions and Limitations

- Valve opening is linearly proportional to the pressure differential.
- No loading on the valve, such as inertia, friction, spring, and so on, is considered.

Parameters

Maximum passage area

Valve passage maximum cross-sectional area. The default value is $1\text{e-}4\text{ m}^2$.

Cracking pressure

Pressure level at which the orifice of the valve starts to open. The default value is $3\text{e}4\text{ Pa}$.

Maximum opening pressure

Pressure differential across the valve needed to fully open the valve. Its value must be higher than the cracking pressure. The default value is $1.2\text{e}5\text{ Pa}$.

Flow discharge coefficient

Semi-empirical parameter for valve capacity characterization. Its value depends on the geometrical properties of the orifice, and usually is provided in textbooks or manufacturer data sheets. The default value is 0.7 .

Laminar transition specification

Select how the block transitions between the laminar and turbulent regimes:

- **Pressure ratio** — The transition from laminar to turbulent regime is smooth and depends on the value of the **Laminar flow pressure ratio** parameter. This method provides better simulation robustness.
- **Reynolds number** — The transition from laminar to turbulent regime is assumed to take place when the Reynolds number reaches the value specified by the **Critical Reynolds number** parameter.

Laminar flow pressure ratio

Pressure ratio at which the flow transitions between laminar and turbulent regimes. The default value is 0.999 . This parameter is visible only if the **Laminar transition specification** parameter is set to **Pressure ratio**.

Critical Reynolds number

The maximum Reynolds number for laminar flow. The value of the parameter depends on the orifice geometrical profile. You can find recommendations on the parameter value in hydraulics textbooks. The default value is 12, which corresponds to a round orifice in thin material with sharp edges. This parameter is visible only if the **Laminar transition specification** parameter is set to Reynolds number.

Leakage area

The total area of possible leaks in the completely closed valve. The main purpose of the parameter is to maintain numerical integrity of the circuit by preventing a portion of the system from getting isolated after the valve is completely closed. The parameter value must be greater than 0. The default value is $1e-12 \text{ m}^2$.

Opening dynamics

Select one of the following options:

- **Do not include valve opening dynamics** — The valve sets its orifice passage area directly as a function of pressure. If the area changes instantaneously, so does the flow equation. This is the default.
- **Include valve opening dynamics** — Provide continuous behavior that is more physically realistic, by adding a first-order lag during valve opening and closing. Use this option in hydraulic simulations with the local solver for real-time simulation. This option is also helpful if you are interested in valve opening dynamics in variable step simulations.

Opening time constant

The time constant for the first order response of the valve opening. This parameter is available only if **Opening dynamics** is set to **Include valve opening dynamics**. The default value is 0.1 s.

Initial area

The initial opening area of the valve. This parameter is available only if **Opening dynamics** is set to **Include valve opening dynamics**. The default value is $1e-12 \text{ m}^2$.

Restricted Parameters

When your model is in Restricted editing mode, you cannot modify the following parameter:

- **Opening dynamics**

All other block parameters are available for modification. The actual set of modifiable block parameters depends on the value of the **Opening dynamics** parameter at the time the model entered Restricted mode.

Global Parameters

Parameters determined by the type of working fluid:

- **Fluid density**
- **Fluid kinematic viscosity**

Use the Hydraulic Fluid block or the Custom Hydraulic Fluid block to specify the fluid properties.

Ports

The block has the following ports:

A

Hydraulic conserving port associated with the valve inlet.

B

Hydraulic conserving port associated with the valve outlet.

Examples

The “Hydraulic Flow Rectifier Circuit” example illustrates the use of check valves to build a rectifier that keeps the flow passing through a flow control valve always in the same direction, and to select an appropriate orifice depending on the flow direction.

Extended Capabilities

C/C++ Code Generation

Generate C and C++ code using Simulink® Coder™.

See Also

Pilot-Operated Check Valve

Topics

“Upgrading Simscape Fluids Models Containing Hydraulics (Isothermal) Blocks”

Introduced in R2006a

Check Valve (IL)

Check valve in an isothermal system

Library: Simscape / Fluids / Isothermal Liquid / Valves & Orifices / Directional Control Valves



Description

The Check Valve (IL) block models the flow through a valve from port **A** to port **B**, and restricts flow from traveling from port **B** to port **A**. When the pressure at port **B** meets or exceeds the set pressure threshold, the valve begins to open.

You can model valve opening either linearly or by tabulated data, and you can enable faulty behavior by setting **Enable faults** to On.

Linear Parameterization

When **Opening parameterization** is set to Linear, the valve open area is linearly related to the opening pressure differential.

Opening Pressure

There are two options for valve control:

- When **Opening pressure differential** is set to **Pressure differential**, the control pressure is the pressure differential between ports **A** and **B**. The valve begins to open when P_{control} meets or exceeds the **Cracking pressure differential**.
- When **Opening pressure differential** is set to **Pressure at port A**, the control pressure is the pressure difference between port **A** and atmospheric pressure. When P_{control} meets or exceeds the **Cracking pressure (gauge)**, the valve begins to open.

Opening Area and Pressure

The linear parameterization of the valve area is

$$A_{\text{valve}} = \hat{p}(A_{\text{max}} - A_{\text{leak}}) + A_{\text{leak}},$$

where the normalized pressure, \hat{p} , is

$$\hat{p} = \frac{P_{\text{control}} - P_{\text{cracking}}}{P_{\text{max}} - P_{\text{cracking}}}.$$

Mass Flow Rate Equation

Mass is conserved through the valve:

$$\dot{m}_A + \dot{m}_B = 0.$$

The mass flow rate through the valve is calculated as:

$$\dot{m} = \frac{C_d A_{valve} \sqrt{2\bar{\rho}}}{\sqrt{PR_{loss} \left(1 - \left(\frac{A_{valve}}{A_{port}}\right)^2\right) [\Delta p^2 + \Delta p_{crit}^2]^{1/4}} \Delta p,$$

where:

- C_d is the **Discharge coefficient**.
- A_{valve} is the instantaneous valve open area.
- A_{port} is the **Cross-sectional area at ports A and B**.
- $\bar{\rho}$ is the average fluid density.
- Δp is the valve pressure difference $p_A - p_B$.

The critical pressure difference, Δp_{crit} , is the pressure differential associated with the **Critical Reynolds number**, Re_{crit} , the flow regime transition point between laminar and turbulent flow:

$$\Delta p_{crit} = \frac{\pi \bar{\rho}}{8 A_{valve}} \left(\frac{\nu Re_{crit}}{C_d} \right)^2.$$

Pressure loss describes the reduction of pressure in the valve due to a decrease in area. PR_{loss} is calculated as:

$$PR_{loss} = \frac{\sqrt{1 - \left(\frac{A_{valve}}{A_{port}}\right)^2 (1 - C_d^2)} - C_d \frac{A_{valve}}{A_{port}}}{\sqrt{1 - \left(\frac{A_{valve}}{A_{port}}\right)^2 (1 - C_d^2)} + C_d \frac{A_{valve}}{A_{port}}}.$$

Pressure recovery describes the positive pressure change in the valve due to an increase in area. If you do not wish to capture this increase in pressure, set the **Pressure recovery** to Off. In this case, PR_{loss} is 1.

Tabulated Data Parameterization

When **Opening parameterization** is set to **Tabulated data**, the valve opens according to the user-provided tabulated data of volumetric flow rate and pressure differential between ports **A** and **B**.

Within the limits of the tabulated data, the mass flow rate is calculated as:

$$\dot{m} = \bar{\rho} \dot{V},$$

where:

- \dot{V} is the volumetric flow rate.
- $\bar{\rho}$ is the average fluid density.

When the simulation pressure falls below the first element of the **Pressure drop vector**, $\Delta p_{TLU}(1)$, the mass flow rate is calculated as:

$$\dot{m} = K_{Leak} \bar{\rho} \sqrt{\Delta p}.$$

$$K_{Leak} = \frac{V_{TLU}(1)}{\sqrt{|\Delta p_{TLU}(1)|}},$$

where $V_{TLU}(1)$ is the first element of the **Volumetric flow rate vector**.

When the simulation pressure rises above the last element of the **Pressure drop vector**, $\Delta p_{TLU}(end)$, the mass flow rate is calculated as:

$$\dot{m} = K_{Max} \bar{\rho} \sqrt{\Delta p}$$

$$K_{Max} = \frac{V_{TLU}(end)}{\sqrt{|\Delta p_{TLU}(end)|}}$$

where $V_{TLU}(end)$ is the last element of the **Volumetric flow rate vector**.

Opening Dynamics

The linear parameterization supports valve opening and closing dynamics. If opening dynamics are modeled, a lag is introduced to the flow response to the modeled control pressure. $p_{control}$ becomes the dynamic control pressure, p_{dyn} ; otherwise, $p_{control}$ is the steady-state pressure. The instantaneous change in dynamic control pressure is calculated based on the **Opening time constant**, τ :

$$\dot{p}_{dyn} = \frac{p_{control} - p_{dyn}}{\tau}$$

By default, **Opening dynamics** is set to Off.

Numerically-Smoothed Pressure

At the extremes of the control pressure range, you can maintain numerical robustness in your simulation by adjusting the block **Smoothing factor**. A smoothing function is applied to every calculated control pressure, but primarily influences the simulation at the extremes of this range.

The **Smoothing factor**, s , is applied to the normalized pressure, \hat{p} :

$$\hat{p}_{smoothed} = \frac{1}{2} + \frac{1}{2} \sqrt{\hat{p}^2 + \left(\frac{s}{4}\right)^2} - \frac{1}{2} \sqrt{(\hat{p} - 1)^2 + \left(\frac{s}{4}\right)^2},$$

and the smoothed pressure is:

$$p_{smoothed} = \hat{p}_{smoothed}(p_{max} - p_{set}) + p_{set}$$

Faulty Behavior

When faults are enabled, the valve open area becomes stuck at a specified value in response to one or both of these triggers:

- Simulation time — Faulting occurs at a specified time.
- Simulation behavior — Faulting occurs in response to an external trigger. This exposes port **T**.

Three fault options are available in the **Opening area when faulted** parameter:

- Closed
- Open
- Maintain at last value

Once triggered, the valve remains at the faulted area for the rest of the simulation. You can set the block to issue a fault report as a warning or error message in the Simulink Diagnostic Viewer with the **Reporting when fault occurs** parameter.

Faulting in the Linear Parameterization

In the linear parameterization, the fault options are defined by the valve area:

- Closed — The valve area freezes at the **Leakage area**.
- Open — The valve area freezes at the **Maximum opening area**.
- Maintain at last value — The valve freezes at the open area when the trigger occurs.

Faulting in the Tabulated Data Parameterization

In the tabulated parameterization, the fault options are defined by the mass flow rate through the valve:

- Closed — The valve freezes at the mass flow rate associated with the first elements of the **Volumetric flow rate vector** and the **Pressure drop vector**:

$$\dot{m} = K_{Leak} \bar{\rho} \sqrt{\Delta p}.$$

- Open — The valve freezes at the mass flow rate associated with the last elements of the **Volumetric flow rate vector** and the **Pressure drop vector**:

$$\dot{m} = K_{Max} \bar{\rho} \sqrt{\Delta p}.$$

- Maintain at last value — The valve freezes at the mass flow rate and pressure differential when the trigger occurs:

$$\dot{m} = K_{Last} \bar{\rho} \sqrt{\Delta p},$$

where

$$K_{Last} = \frac{|\dot{m}|}{\bar{\rho} \sqrt{|\Delta p|}}.$$

Predefined Parameterization

Pre-parameterization of the Check Valve (IL) block with manufacturer data is available. This data allows you to model a specific supplier component.

To load a predefined parameterization,

- 1 Click the "Select a predefined parameterization" hyperlink in the Check Valve (IL) block dialog description.
- 2 Select a part from the drop-down menu and click **Update block with selected part**.
- 3 If you change any parameter settings after loading a parameterization, you can check your changes by clicking **Compare block settings with selected part**. Any difference in settings between the block and pre-defined parameterization will display in the MATLAB command window.

Note Predefined parameterizations of Simscape components use available data sources for supplying parameter values. Engineering judgement and simplifying assumptions are used to fill in for missing

data. As a result, deviations between simulated and actual physical behavior should be expected. To ensure requisite accuracy, you should validate simulated behavior against experimental data and refine component models as necessary.

Ports

Conserving

A – Liquid port

isothermal liquid

Entry point to the valve.

B – Liquid port

isothermal liquid

Exit point to the valve.

Input

T – External fault trigger

physical signal

Physical signal port for an external fault trigger. Triggering occurs when the value is greater than 0.5. There is no unit associated with the trigger value.

Dependencies

This port is visible when **Enable faults** is set to On and **Enable external fault trigger** is set to Fault when $T \geq 0.5$.

Parameters

Parameters

Opening parameterization – Method of calculating valve opening

Linear (default) | Tabulated data

Method of calculating valve opening.

- **Linear**: The valve opening area corresponds linearly to the valve pressure.
- **Tabulated data**: The valve mass flow rate is determined from a tabulated valves of volumetric flow rate and pressure differential.

Opening pressure specification – Pressure differential used for valve control

Pressure differential (default) | Pressure at port A

Specifies the control pressure differential. The **Pressure differential** option refers to the pressure difference between ports **A** and **B**. The **Pressure at port A** option refers to the pressure difference between port **A** and atmospheric pressure.

Dependencies

To enable this parameter, set **Opening parameterization** to Linear.

Cracking pressure differential – Threshold pressure

0.01 MPa (default) | positive scalar

Pressure beyond which the valve operation is triggered. This is the *set pressure* when the *control pressure* is the pressure differential between ports **A** and **B**.

Dependencies

To enable this parameter, set **Opening pressure specification** to Pressure differential and **Opening parameterization** to Linear.

Cracking pressure (gauge) – Threshold pressure

0.1 MPa (default) | positive scalar

Gauge pressure beyond which valve operation is triggered when the *control pressure* is the pressure differential between port **A** and atmospheric pressure.

Dependencies

To enable this parameter, set **Opening parameterization** to Linear and **Opening pressure specification** to Pressure at port A.

Maximum opening pressure differential – Valve differential pressure maximum

0.1 MPa (default) | positive scalar

Maximum valve differential pressure. This parameter provides an upper limit to the pressure so that system pressures remain realistic.

Dependencies

To enable this parameter, set **Opening parameterization** to Linear and **Opening pressure specification** to Pressure differential.

Maximum opening pressure (gauge) – Valve pressure maximum

0.2 MPa (default) | positive scalar

Maximum valve gauge pressure. This parameter provides an upper limit to the pressure so that system pressures remain realistic.

Dependencies

To enable this parameter, set **Opening parameterization** to Linear and **Opening pressure specification** to Pressure at port A.

Maximum opening area – Area of fully opened valve

1e-4 m² (default) | positive scalar

Cross-sectional area of the valve in its fully open position.

Dependencies

To enable this parameter, set **Opening parameterization** to Linear.

Leakage area – Valve gap area when in fully closed position

1e-12 m² (default) | positive scalar

Sum of all gaps when the valve is in its fully closed position. Any area smaller than this value is saturated to the specified leakage area. This contributes to numerical stability by maintaining continuity in the flow.

Dependencies

To enable this parameter, set **Opening parameterization** to Linear.

Cross-sectional area at ports A and B – Area at valve entry or exit

inf m² (default) | positive scalar

Cross-sectional area at the entry and exit ports **A** and **B**. These areas are used in the pressure-flow rate equation that determines the mass flow rate through the valve.

Dependencies

To enable this parameter, set **Opening parameterization** to Linear.

Discharge coefficient – Discharge coefficient

0.64 (default) | positive scalar

Correction factor that accounts for discharge losses in theoretical flows.

Dependencies

To enable this parameter, set **Opening parameterization** to Linear.

Critical Reynolds number – Upper Reynolds number limit for laminar flow

150 (default) | positive scalar

Upper Reynolds number limit for laminar flow through the valve.

Dependencies

To enable this parameter, set **Opening parameterization** to Linear.

Smoothing factor – Numerical smoothing factor

0.01 (default) | positive scalar

Continuous smoothing factor that introduces a layer of gradual change to the flow response when the valve is in near-open or near-closed positions. Set this value to a nonzero value less than one to increase the stability of your simulation in these regimes.

Dependencies

To enable this parameter, set **Opening parameterization** to Linear.

Pressure recovery – Whether to account for pressure increase in area expansions

Off (default) | On

Whether to account for pressure increase when fluid flows from a region of smaller cross-sectional area to a region of larger cross-sectional area.

Dependencies

To enable this parameter, set **Opening parameterization** to Linear.

Opening dynamics – Whether to account for flow response to valve opening

Off (default) | On

Whether to account for transient effects to the fluid system due to opening the valve. Setting **Opening dynamics** to On approximates the opening conditions by introducing a first-order lag in the flow response. The **Opening time constant** also impacts the modeled opening dynamics.

Dependencies

To enable this parameter, set **Opening parameterization** to Linear.

Opening time constant — Valve opening time constant

0.1 s (default) | positive scalar

Constant that captures the time required for the fluid to reach steady-state when opening or closing the valve from one position to another. This parameter impacts the modeled opening dynamics.

Dependencies

To enable this parameter, set **Opening parameterization** to Linear and **Opening dynamics** to On.

Pressure drop vector — Vector of pressure data for tabulated data parameterization

[0.01 : 0.01 : 0.1] MPa (default) | 1-by-*n* vector

Vector of pressure differential values for the tabular parameterization of valve opening. This vector must have the same number of elements as the **Volumetric flow rate vector** parameter. The vector elements must be listed in ascending order and must be greater than 0.

Dependencies

To enable this parameter, set **Opening parameterization** to Tabulated data.

Volumetric flow rate vector — Vector of volumetric flow rate for tabulated data parameterization

[.000358, .045, .11, .191, .284, .39, .505, .63, .764, .905] .* 1e-3 m³/s (default) | 1-by-*n* vector

Vector of volumetric flow rate values for the tabular parameterization of valve opening. This vector must have the same number of elements as the **Pressure drop vector** parameter. The vector elements must be listed in ascending order.

Dependencies

To enable this parameter, set **Opening parameterization** to Tabulated data.

Faults

Enable faults — Fault option

Off (default) | On

Enable externally or temporally triggered faults. When faulting occurs, the valve area normally set by the opening parameterization will be set to the value specified in the **Opening area when faulted** parameter.

Opening area when faulted — Set faulted characteristics

Closed (default) | Open | Maintain at last value

Sets the faulted valve area or mass flow rate. You can choose for the valve to seize at the fully closed or fully open position, or at the conditions when faulting is triggered. This parameter sets the area

when **Opening parameterization** is set to **Linear** and the mass flow rate when **Opening parameterization** is set to **Tabulated data**.

Dependencies

To enable this parameter, set **Enable faults** to **On**.

Enable external fault trigger – External trigger option

Off (default) | Fault when $T \geq 0.5$

Enables port **T**. A physical signal at port **T** that is greater than 0.5 triggers faulting.

Dependencies

To enable this parameter, set **Enable faults** to **On**.

Enable temporal fault trigger – Temporal trigger option

Off (default) | On

Enables fault triggering at a specified time. When the **Simulation time for fault event** is reached, the valve area will be set to the value specified in the **Opening area when faulted** parameter.

Dependencies

To enable this parameter, set **Enable faults** to **On**.

Simulation time for fault event – Time at which faulting is triggered

5 s (default) | positive scalar

When the **Simulation time for fault event** is reached, the valve area is set to the value specified in the **Opening area when faulted** parameter.

Dependencies

To enable this parameter, set **Enable faults** to **On** and **Enable temporal fault trigger** to **On**.

Reporting when fault occurs – Fault condition report

None (default) | Warning | Error

Reporting preference for the fault condition. When reporting is set to **Warning** or **Error**, a message is displayed in the Simulink Diagnostic Viewer. When **Error** is selected, the simulation will stop if faulting occurs.

Dependencies

To enable this parameter, set **Enable faults** to **On**.

See Also

Pilot-Operated Check Valve (IL) | Pressure Relief Valve (IL) | Counterbalance Valve (IL) | Pressure Compensator Valve (IL)

Introduced in R2020a

Check Valve (G)

Valve for limiting flow to a single (forward) direction

Library: Simscape / Fluids / Gas / Valves & Orifices / Directional Control Valves



Description

The Check Valve (G) block models an orifice with a unidirectional opening mechanism to prevent unwanted backflow. The opening mechanism, often spring-loaded by design, responds to pressure, (typically) opening the orifice when the pressure gradient across it falls from inlet (port **A**) to outlet (port **B**), but forcing it shut otherwise. Check valves protect components upstream against pressure surges, temperature spikes, and (in real systems) chemical contamination stemming from points downstream.

The valve opens by degrees, beginning at its cracking pressure, and continuing to the end of its pressure regulation range. The cracking pressure gives the initial resistance, due to friction or spring forces, that the valve must overcome to open by a sliver (or to *crack* open). Below this threshold, the valve is closed and only leakage flow can pass. Past the end of the pressure regulation range, the valve is fully open and the flow at a maximum (determined by the instantaneous pressure conditions).

The cracking pressure assumes an important role in check valves installed upside down. There, the weight of the opening element—such as a ball or piston—and the elevation head of the fluid can act to open the valve. (The elevation head can arise in a model from a pipe upstream of the inlet when it is vertical or given a slant.) A sufficient cracking pressure keeps the valve from opening inadvertently even if placed at a disadvantageous angle.

The flow can be laminar or turbulent, and it can reach (up to) sonic speeds. This happens at the vena contracta, a point just past the throat of the valve where the flow is both its narrowest and fastest. The flow then chokes and its velocity saturates, with a drop in downstream pressure no longer sufficing to increase its velocity. Choking occurs when the back-pressure ratio hits a critical value characteristic of the valve. Supersonic flow is not captured by the block.

Control and Other Pressures

The pressure to which the valve responds is its control pressure. In a typical check valve (and by default in this block), that pressure is the drop from inlet to outlet. This setting ensures that the valve in fact closes if the direction of flow should reverse.

For special cases, an alternative control pressure is provided: the gauge pressure at the inlet. Use it if you know that the inlet will always be at a higher pressure than the outlet (for example, when the inlet connects to a pressure source, such as a pump).

You can select an appropriate control pressure for your model—either **Pressure differential** or **Pressure at port A (gauge)**—using the **Pressure control specification** drop-down list.

Pressure Differential

When the **Pressure control specification** parameter is set to **Pressure differential**, the control pressure is computed as:

$$p_{\text{Ctl}} = p_A - p_B,$$

where p is instantaneous pressure. The subscript **Ctl** denotes the control value and the subscripts **A** and **B** the inlet and outlet, respectively. The port pressures are instantaneous values determined (against absolute zero) during simulation. The cracking pressure is likewise defined as:

$$P_{\text{Crk}} = [P_A - P_B]_{\text{Crk}},$$

where P is a constant pressure parameter. The subscript **Crk** denotes the cracking value (here a differential). The term in parentheses is obtained as a constant from the **Cracking pressure differential** block parameter. Similarly for the maximum pressure of the valve (at which the valve is fully open):

$$P_{\text{Max}} = [P_A - P_B]_{\text{Max}},$$

where the subscript **Max** denotes the maximum value of the valve. Here too the term in parentheses is obtained as a constant, from the **Maximum opening pressure differential** block parameter.

Pressure at port A

When the **Pressure control specification** parameter is set to **Pressure at port A**, the control pressure is computed as:

$$p_{\text{Ctl}} = p_A.$$

The port pressure is an instantaneous value determined (against absolute zero) during simulation. For the cracking pressure:

$$P_{\text{Crk}} = P_{A,\text{Crk}} + P_{\text{Atm}},$$

where the subscript **A, Crk** denotes the cracking value, specified as a gauge pressure at port **A**. This value is obtained as a constant from the **Cracking pressure (gauge)** block parameter. The subscript **Atm** denotes the atmospheric value (specified in the Gas Properties (G) block of the model). The maximum pressure of the valve is:

$$P_{\text{Max}} = P_{A,\text{Max}} + P_{\text{Atm}},$$

where the subscript **A, Max** denotes the maximum value, specified as a gauge pressure at port **A**. This value is obtained as a constant from the **Maximum opening pressure (gauge)** block parameter.

Control Pressure Overshoot

The degree to which the control pressure exceeds the cracking pressure determines how much the valve will open. The pressure overshoot is expressed here as a fraction of the (width of the) pressure regulation range:

$$\hat{p} = \frac{p_{\text{Ctl}} - P_{\text{Crk}}}{P_{\text{Max}} - P_{\text{Crk}}}.$$

The control pressure (p_{Ctl}), cracking pressure (p_{Set}), and maximum opening pressure (P_{Max}) correspond to the control pressure specification chosen (Pressure differential or Pressure at port A).

The fraction—technically, the overshoot *normalized*—is valued at 0 in the fully closed valve and 1 in the fully open valve. If the calculation should return a value outside of these bounds, the nearest of the two is used instead. (In other words, the fraction *saturates* at 0 and 1.)

Numerical Smoothing

The normalized control pressure, p , spans three pressure regions. Below the cracking pressure of the valve, its value is a constant zero. Above the maximum pressure of the same, it is 1. In between, it varies, as a linear function of the (effective) control pressure, p_{Ctl} .

The transitions between the regions are sharp and their slopes discontinuous. These pose a challenge to variable-step solvers (the sort commonly used with Simscape models). To precisely capture discontinuities, referred to in some contexts as *zero crossing events*, the solver must reduce its time step, pausing briefly at the time of the crossing in order to recompute its Jacobian matrix (a representation of the dependencies between the state variables of the model and their time derivatives).

This solver strategy is efficient and robust when discontinuities are present. It makes the solver less prone to convergence errors—but it can considerably extend the time needed to finish the simulation run, perhaps excessively so for practical use in real-time simulation. An alternative approach, used here, is to remove the discontinuities altogether.

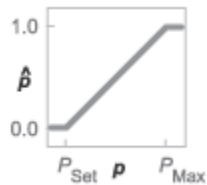

Normalized pressure overshoot with sharp transitions

The block removes the discontinuities by smoothing them over a specified time scale. The smoothing, which adds a slight distortion to the normalized inlet pressure, ensures that the valve eases into its limiting positions rather than snap (abruptly) into them. The smoothing is optional: you can disable it by setting its time scale to zero. The shape and scale of the smoothing, when applied, derives in part from the cubic polynomials:

$$\lambda_L = 3\bar{p}_L^2 - 2\bar{p}_L^3$$

and

$$\lambda_R = 3\bar{p}_R^2 - 2\bar{p}_R^3,$$

where

$$\bar{p}_L = \frac{\hat{p}}{\Delta p^*}$$

and

$$\bar{p}_R = \frac{\hat{p} - (1 - \Delta p^*)}{\Delta p^*}.$$

In the equations:

- λ_L is the smoothing expression for the transition from the maximally closed position.
- λ_R is the smoothing expression for the transition from the fully open position.
- Δp^* is the (unitless) characteristic width of the pressure smoothing region:

$$\Delta p^* = f^* \frac{1}{2},$$

where f^* is a smoothing factor valued between 0 and 1 and obtained from the block parameter of the same name.

When the smoothing factor is 0, the normalized inlet pressure stays in its original form—no smoothing applied—and its transitions remain abrupt. When it is 1, the smoothing spans the whole of the pressure regulation range (with the normalized inlet pressure taking the shape of an S-curve).

At intermediate values, the smoothing is limited to a fraction of that range. A value of 0.5, for example, will smooth the transitions over a quarter of the pressure regulation range on each side (for a total smooth region of half the regulation range).

The smoothing adds two new regions to the normalized pressure overshoot—one for the smooth transition on the left, another for that on the right, giving a total of five regions. These are expressed in the piecewise function:

$$\hat{p}^* = \begin{cases} 0, & \hat{p} \leq 0 \\ \hat{p} \lambda_L, & \hat{p} < \Delta p^* \\ \hat{p}, & \hat{p} \leq 1 - \Delta p^*, \\ \hat{p}(1 - \lambda_R) + \lambda_R, & \hat{p} < 1 \\ 1 & \hat{p} \geq 1 \end{cases}$$

where the asterisk denotes a smoothed variable (the normalized control pressure overshoot). The figure shows the effect of smoothing on the sharpness of the transitions.

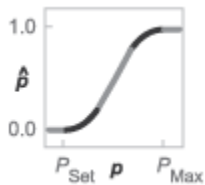

Sonic Conductance

As the normalized control pressure varies during simulation, so does the mass flow rate through the valve. The relationship between the two variables, however, is indirect. The mass flow rate is defined in terms of the valve's sonic conductance and it is this quantity that the normalized inlet pressure determines.

Sonic conductance, if you are unfamiliar with it, describes the ease with which a gas will flow when it is choked—when its velocity is at its theoretical maximum (the local speed of sound). Its

measurement and calculation are covered in detail in the ISO 6358 standard (on which this block is based).

Only one value is commonly reported in valve data sheets: one taken at steady state in the fully open position. This is the same specified in the **Sonic conductance at maximum flow** parameter when the **Valve parameterization** setting is **Sonic conductance**. For values across the opening range of the valve, this maximum is scaled by the normalized pressure overshoot:

$$C = (C_{\text{Max}} - C_{\text{Min}})\hat{p} + C_{\text{Min}},$$

where C is sonic conductance and the subscripts **Max** and **Min** denote its values in the fully open and fully closed valve.

Other Parameterizations

Because sonic conductance may not be available (or the most convenient choice for your model), the block provides several equivalent parameterizations. Use the **Valve parameterization** drop-down list to select the best for the data at hand. The parameterizations are:

- Restriction area
- Sonic conductance
- Cv coefficient (USCS)
- Kv coefficient (SI)

The parameterizations differ only in the data that they require of you. Their mass flow rate calculations are still based on sonic conductance. If you select a parameterization other than **Sonic conductance**, then the block converts the alternate data—the (computed) opening area or a (specified) flow coefficient—into an equivalent sonic conductance.

Flow Coefficients

The flow coefficients measure what is, at bottom, the same quantity—the flow rate through the valve at some agreed-upon temperature and pressure differential. They differ only in the standard conditions used in their definition and in the physical units used in their expression:

- C_v is measured at a generally accepted temperature of 60 °F and pressure drop of 1 PSI; it is expressed in imperial units of US gpm. This is the flow coefficient used in the model when the **Valve parameterization** block parameter is set to **Cv coefficient (USCS)**.
- K_v is measured at a generally accepted temperature of 15 °C and pressure drop of 1 bar; it is expressed in metric units of m³/h. This is the flow coefficient used in the model when the **Valve parameterization** block parameter is set to **Kv coefficient (SI)**.

Sonic Conductance Conversions

If the valve parameterization is set to **Cv Coefficient (USCS)**, the sonic conductance is computed at the maximally closed and fully open valve positions from the **Cv coefficient (SI) at maximum flow** and **Cv coefficient (SI) at leakage flow** block parameters:

$$C = (4 \times 10^{-8} C_v) m^3 / (sPa),$$

where C_v is the flow coefficient value at maximum or leakage flow. The subsonic index, m , is set to 0.5 and the critical pressure ratio, b_{cr} , is set to 0.3. (These are used in the mass flow rate calculations given in the Momentum Balance section.)

If the K_v coefficient (SI) parameterization is used instead, the sonic conductance is computed at the same valve positions (maximally closed and fully open) from the **K_v coefficient (USCS) at maximum flow** and **K_v coefficient (USCS) at leakage flow** block parameters:

$$C = (4.758 \times 10^{-8} K_v) m^3 / (sPa),$$

where K_v is the flow coefficient value at maximum or leakage flow. The subsonic index, m , is set to 0.5 and the critical pressure ratio, b_{cr} , is set to 0.3.

For the Restriction area parameterization, the sonic conductance is computed (at the same valve positions) from the **Maximum opening area**, and **Leakage area** block parameters:

$$C = (0.128 \times 4S/\pi)L/(sbar),$$

where S is the opening area at maximum or leakage flow. The subsonic index, m , is set to 0.5 while the critical pressure ratio, b_{cr} is computed from the expression:

$$0.41 + 0.272 \left[\frac{\hat{p}(S_{Max} - S_{Leak}) + S_{Leak}}{S} \right]^{0.25}.$$

Momentum Balance

The causes of those pressure losses incurred in the passages of the valve are ignored in the block. Whatever their natures—sudden area changes, flow passage contortions—only their cumulative effect is considered during simulation. This effect is assumed to reflect entirely in the sonic conductance of the valve (or in the data of the alternate valve parameterizations).

Mass Flow Rate

When the flow is choked, the mass flow rate is a function of the sonic conductance of the valve and of the thermodynamic conditions (pressure and temperature) established at the inlet. The function is linear with respect to pressure:

$$\dot{m}_{ch} = C\rho_0 p_{in} \sqrt{\frac{T_0}{T_{in}}},$$

where:

- C is the sonic conductance inside the valve. Its value is obtained from the block parameter of the same name or by conversion of other block parameters (the exact source depending on the **Valve parameterization** setting).
- ρ is the gas density, here at standard conditions (subscript 0), obtained from the **Reference density** block parameter.
- p is the absolute gas pressure, here corresponding to the inlet (in).
- T is the gas temperature at the inlet (in) or at standard conditions (0), the latter obtained from the **Reference temperature** block parameter.

When the flow is subsonic, and therefore no longer choked, the mass flow rate becomes a nonlinear function of pressure—both that at the inlet as well as the reduced value at the outlet. In the turbulent flow regime (with the outlet pressure contained in the back-pressure ratio of the valve), the mass flow rate expression is:

$$\dot{m}_{tur} = C\rho_0 p_{in} \sqrt{\frac{T_0}{T_{in}}} \left[1 - \left(\frac{p_r - b_{cr}}{1 - b_{cr}} \right)^2 \right]^m,$$

where:

- p_r is the back-pressure ratio, or that between the outlet pressure (p_{out}) and the inlet pressure (p_{in}):

$$P_r = \frac{p_{out}}{p_{in}}$$

- b_{cr} is the critical pressure ratio at which the flow becomes choked. Its value is obtained from the block parameter of the same name or by conversion of other block parameters (the exact source depending on the **Valve parameterization** setting).
- m is the *subsonic index*, an empirical coefficient used to more accurately characterize the behavior of subsonic flows. Its value is obtained from the block parameter of the same name or by conversion of other block parameters (the exact source depending on the **Valve parameterization** setting).

When the flow is laminar (and still subsonic), the mass flow rate expression changes to:

$$\dot{m}_{lam} = C\rho_0 p_{in} \left[\frac{1 - p_r}{1 - b_{lam}} \sqrt{\frac{T_0}{T_{in}}} \left[1 - \left(\frac{b_{lam} - b_{cr}}{1 - b_{cr}} \right)^2 \right]^m \right]$$

where b_{lam} is the critical pressure ratio at which the flow transitions between laminar and turbulent regimes (obtained from the **Laminar flow pressure ratio** block parameter). Combining the mass flow rate expressions into a single (piecewise) function, gives:

$$\dot{m} = \begin{cases} \dot{m}_{lam}, & b_{lam} \leq p_r < 1 \\ \dot{m}_{tur}, & b_{cr} \leq p_r < p_{lam}, \\ \dot{m}_{ch}, & p_r < b_{Cr} \end{cases}$$

with the top row corresponding to subsonic and laminar flow, the middle row to subsonic and turbulent flow, and the bottom row to choked (and therefore sonic) flow.

Mass Balance

The volume of fluid inside the valve, and therefore the mass of the same, is assumed to be very small and it is, for modeling purposes, ignored. As a result, no amount of gas can accumulate there. By the principle of conservation of mass, the mass flow rate into the valve through one port must therefore equal that out of the valve through the other port:

$$\dot{m}_A + \dot{m}_B = 0,$$

where \dot{m} is defined as the mass flow rate *into* the valve through port **A** or **B**. Note that in this block the flow can reach but not exceed sonic speeds.

Energy Balance

The valve is modeled as an adiabatic component. No heat exchange can occur between the gas and the wall that surrounds it. No work is done on or by the gas as it traverses from inlet to outlet. With these assumptions, energy can flow by advection only, through ports **A** and **B**. By the principle of conservation of energy, the sum of the port energy flows must then always equal zero:

$$\phi_A + \phi_B = 0,$$

where ϕ is defined as the energy flow rate *into* the valve through one of the ports (**A** or **B**).

Ports

Conserving

A – Valve entrance

gas

Opening through which the working fluid must enter the valve.

B – Valve entrance

gas

Opening through which the working fluid must exit the valve.

Parameters

Pressure control specification – Choice of pressure measurement to use as valve control signal

Pressure differential (default) | Pressure at port A

Choice of pressure measurement to use as valve control signal. The block uses this setting to determine when the valve should begin to open. In the default setting (Pressure differential), the opening pressure of the valve is expressed as a pressure drop from inlet to outlet. In the alternative setting (Pressure at port A), it is expressed as an absolute inlet pressure.

Cracking pressure differential – Pressure drop, from inlet to outlet, required to open the valve

0.01 MPa (default) | positive scalar in units of pressure

Minimum pressure drop from inlet to outlet required to open the valve. This value marks the beginning of the pressure differential range of the valve (over which it progressively opens to allow for increased flow).

Dependencies

This parameter is active and exposed in the block dialog box when the **Pressure control specification** parameter is set to Pressure differential.

Maximum opening pressure differential – Pressure drop, from inlet to outlet, at which the valve is fully open

0.02 MPa (default) | positive scalar in units of pressure

Pressure drop from inlet to outlet at which the valve is fully open. This value marks the end of the pressure differential range of the valve (over which the same progressively opens to allow for increased flow).

Dependencies

This parameter is active and exposed in the block dialog box when the **Pressure control specification** parameter is set to Pressure differential.

Cracking pressure (gauge) – Minimum gauge pressure at the inlet required to open the valve

0.01 MPa (default) | positive scalar in units of pressure

Minimum gauge pressure at the inlet (port **A**) required to open the valve. This value marks the beginning of the pressure range of the valve (over which the same progressively opens to allow for increased flow).

Dependencies

This parameter is active and exposed in the block dialog box when the **Pressure control specification** parameter is set to Pressure at port A.

Maximum opening pressure (gauge) — Pressure drop, from inlet to outlet, at which the valve is fully open

0.02 MPa (default) | positive scalar in units of pressure

Pressure drop from inlet to outlet at which the valve is fully open. This value marks the end of the pressure differential range of the valve (over which the same progressively opens to allow for increased flow).

Dependencies

This parameter is active and exposed in the block dialog box when the **Pressure control specification** parameter is set to Pressure at port A.

Valve parameterization — Method by which to characterize the opening of the valve

Sonic conductance (default) | Cv coefficient (USCS) | Kv coefficient (SI) | Restriction area

Choice of ISO method to use in the calculation of mass flow rate. All calculations are based on the **Sonic conductance** parameterization; if a different option is selected, the data specified in converted into equivalent sonic conductance, critical pressure ratio, and subsonic index. See the block description for more information on the conversion.

This parameter determines which measures of valve opening you must specify—and therefore which of those measures appear as parameters in the block dialog box.

Sonic conductance at maximum flow — Measure of maximum flow rate at reference upstream conditions

1.6 l/s/bar (default) | positive scalar in units of volume/time/pressure

Equivalent measure of the maximum flow rate allowed through the valve at some reference inlet conditions, generally those outlined in ISO 8778. The flow is at a maximum when the valve is fully open and the flow velocity is choked (it being saturated at the local speed of sound). This is the value generally reported by manufacturers in technical data sheets.

Sonic conductance is defined as the ratio of the mass flow rate through the valve to the product of the pressure and density upstream of the valve inlet. This parameter is often referred to in the literature as the *C-value*.

Dependencies

This parameter is active and exposed in the block dialog box when the **Valve parameterization** setting is Sonic conductance.

Sonic conductance at leakage flow — Measure of minimum flow rate at reference upstream conditions

1e-5 l/s/bar (default) | positive scalar in units of volume/time/pressure

Equivalent measure of the minimum flow rate allowed through the valve at some reference inlet conditions, generally those outlined in ISO 8778. The flow is at a minimum when the valve is maximally closed and only a small leakage area—due to sealing imperfections, say, or natural valve tolerances—remains between its ports.

Sonic conductance is defined as the ratio of the mass flow rate through the valve to the product of the pressure and density upstream of the valve inlet. This parameter is often referred to in the literature as the *C-value*.

This parameter serves primarily to ensure that closure of the valve does not cause portions of the gas network to become isolated (a condition known to cause problems in simulation). The exact value specified here is less important than its being a (very small) number greater than zero.

Dependencies

This parameter is active and exposed in the block dialog box when the **Valve parameterization** setting is Sonic conductance.

Critical pressure ratio — Back-pressure ratio, at reference upstream conditions, at which the flow rate is a maximum

0.3 (default) | positive unitless scalar

Ratio of downstream to upstream absolute pressures at which the flow becomes choked (and its velocity becomes saturated at the local speed of sound). This parameter is often referred to in the literature as the *b-value*. Enter a number greater than or equal to zero and smaller than the **Laminar flow pressure ratio** block parameter.

Dependencies

This parameter is active and exposed in the block dialog box when the **Valve parameterization** setting is Sonic conductance.

Subsonic index — Exponent used to more accurately characterize flow in the subsonic regime

0.5 (default) | positive unitless scalar

Empirical exponent used to more accurately calculate the mass flow rate through the valve when the flow is subsonic. This parameter is sometimes referred to as the *m-index*. Its value is approximately 0.5 for valves (and other components) whose flow paths are fixed.

Dependencies

This parameter is active and exposed in the block dialog box when the **Valve parameterization** setting is Sonic conductance.

Cv coefficient (USCS) at maximum flow — Flow coefficient of the fully open valve expressed in US customary units

0.4 (default) | positive scalar in units of ft³/min

Flow coefficient of the fully open valve, expressed in the US customary units of ft³/min (as described in NFPA T3.21.3). This parameter measures the relative ease with which the gas will traverse the valve when driven by a given pressure differential. This is the value generally reported by manufacturers in technical data sheets.

Dependencies

This parameter is active and exposed in the block dialog box when the **Valve parameterization** setting is **Cv coefficient (USCS)**.

Cv coefficient (USCS) at leakage flow — Flow coefficient of the maximally closed valve expressed in US customary units

1e-6 (default) | positive scalar in units of ft³/min

Flow coefficient of the maximally closed valve, expressed in the US customary units of ft³/min (as described in NFPA T3.21.3). This parameter measures the relative ease with which the gas will traverse the valve when driven by a given pressure differential.

The purpose of this parameter is primarily to ensure that closure of the valve does not cause portions of the gas network to become isolated (a condition known to cause problems in simulation). The exact value specified here is less important than its being a (very small) number greater than zero.

Dependencies

This parameter is active and exposed in the block dialog box when the **Valve parameterization** setting is **Cv coefficient (USCS)**.

Kv coefficient (SI) at maximum flow — Flow coefficient of the fully open valve expressed in SI units

0.3 (default) | positive scalar in units of m³/hr

Flow coefficient of the fully open valve, expressed in the SI units of m³/hr. This parameter measures the relative ease with which the gas will traverse the valve when driven by a given pressure differential. This is the value generally reported by manufacturers in technical data sheets.

Dependencies

This parameter is active and exposed in the block dialog box when the **Valve parameterization** setting is **Kv coefficient (SI)**.

Kv coefficient (SI) at leakage flow — Flow coefficient of the maximally closed valve expressed in SI units

1e-6 (default) | positive scalar in units of m³/hr

Flow coefficient of the maximally closed valve, expressed in the SI units of m³/hr. This parameter measures the relative ease with which the gas will traverse the valve when driven by a given pressure differential.

The purpose of this parameter is primarily to ensure that closure of the valve does not cause portions of the gas network to become isolated (a condition known to cause problems in simulation). The exact value specified here is less important than its being a (very small) number greater than zero.

Dependencies

This parameter is active and exposed in the block dialog box when the **Valve parameterization** setting is **Kv coefficient (SI)**.

Maximum opening area — Opening area in the fully open position due to sealing imperfections

1e-4 m² (default) | positive scalar in units of area

Opening area of the valve in the fully open position, when the valve is at the upper limit of the pressure regulation range. The block uses this parameter to scale the chosen measure of valve opening—sonic conductance, say, or C_V flow coefficient—throughout the pressure regulation range.

Dependencies

This parameter is active and exposed in the block dialog box when the **Valve parameterization** setting is **Restriction area**.

Leakage area — Opening area in the maximally closed position due to sealing imperfections

$1e-12 \text{ m}^2$ (default) | positive scalar in units of area

Opening area of the valve in the maximally closed position, when only internal leakage between the ports remains. This parameter serves primarily to ensure that closure of the valve does not cause portions of the gas network to become isolated (a condition known to cause problems in simulation). The exact value specified here is less important than its being a (very small) number greater than zero.

Dependencies

This parameter is active and exposed in the block dialog box when the **Valve parameterization** setting is **Restriction area**.

Cross-sectional area at ports A and B — Area normal to the flow path at the valve ports

0.01 m^2 (default) | positive scalar in units of area

Area normal to the flow path at the valve ports. The ports are assumed to be the same in size. The flow area specified here should ideally match those of the inlets of adjoining components.

Laminar flow pressure ratio — Pressure ratio at which the flow transitions between laminar and turbulent

0.999 (default) | positive unitless scalar

Pressure ratio at which the flow transitions between laminar and turbulent flow regimes. The pressure ratio is the fraction of the absolute pressure downstream of the valve over that just upstream of it. The flow is laminar when the actual pressure ratio is above the threshold specified here and turbulent when it is below. Typical values range from 0.995 to 0.999 .

Reference temperature — ISO 8778 reference temperature

293.15 K (default) | scalar in units of temperature

Temperature at standard reference atmosphere, defined as 293.15 K in ISO 8778.

Reference density — ISO 8778 reference density

1.185 (default) | positive scalar in units of mass/volume

Density at standard reference atmosphere, defined as 1.185 kg/m^3 in ISO 8778.

Smoothing factor — Amount of smoothing to apply to the valve opening area function

0 (default)

Amount of smoothing to apply to the opening area function of the valve. This parameter determines the widths of the regions to be smoothed—one located at the fully open position, the other at the fully closed position.

The smoothing superposes on each region of the opening area function a nonlinear segment (a third-order polynomial function, from which the smoothing arises). The greater the value specified here, the greater the smoothing is, and the broader the nonlinear segments become.

At the default value of θ , no smoothing is applied. The transitions to the maximally closed and fully open positions then introduce discontinuities (associated with zero-crossings), which tend to slow down the rate of simulation.

Extended Capabilities

C/C++ Code Generation

Generate C and C++ code using Simulink® Coder™.

See Also

Variable Orifice ISO 6358 (G) | Pilot-Operated Check Valve (G)

Introduced in R2018b

Check Valve (TL)

Valve for the prevention of flow aimed counter to its intended direction

Library: Simscape / Fluids / Thermal Liquid / Valves & Orifices /
Directional Control Valves



Description

The Check Valve (TL) block models the opening characteristics of a proportional valve that is forced shut when the pressure difference between its ports is reversed (or, more precisely, dropped below a threshold known as the *cracking pressure*). Check valves are common in backflow prevention devices, such as those used in public water supply networks, where contaminated water downstream of a water main must not be allowed to return upstream. No specific valve shutoff mechanism—whether ball, disc, diaphragm, or other—is assumed in the block. The allowed direction of flow is always from port **A** to port **B**.

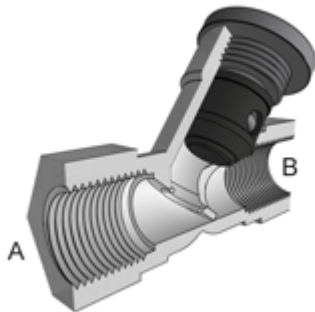

Y-Shaped Check Valve with Piston-Type Control Member Partially Retracted

The valve cracks open when the pressure drop across it rises above the cracking pressure specified in the block. The opening area increases linearly with pressure, save for two small pressure intervals near the fully open and fully closed positions (over which nonlinear smoothing is applied in order to remove numerical discontinuities). When the pressure drop reaches the maximum value specified in the block, the valve is fully open and its opening area no longer increases with pressure. The flow rate through the valve is never truly zero as a small leakage area remains when the pressure falls below the cracking pressure.

Valve Opening Area

The (smoothed) valve opening area is first computed as a linear function of pressure, either that at the valve entrance (port **A**) or the drop between those at the entrance and at the outlet (port **B**). Which of these pressures—termed control pressures—features in the area calculations depends on the setting of the **Pressure specification method** block parameter:

$$p_{\text{Control}} = \begin{cases} p_A, & \text{Pressure at port A method} \\ p_A - p_B, & \text{Pressure differential method} \end{cases}$$

where p is pressure; the subscript **Control** indicates the value to be used in determining the opening area of the valve. Subscripts A and B denote the thermal liquid ports at which the pressures are obtained. The pressures at the ports are always defined as absolute pressures. The cracking pressure, at which the opening area is at a minimum, is similarly defined:

$$p_{\text{Crack}} = \begin{cases} p_{\text{Crack,G}} + p_{\text{Atm}}, & \text{Pressure at port A method} \\ \Delta p_{\text{Crack}}, & \text{Pressure differential method} \end{cases}$$

where the subscript **Crack** indicates a valve just cracking open, subscript G a gauge value, and subscript **Atm** the standard atmospheric value. The value of $p_{\text{Crack,G}}$ is obtained from the **Cracking pressure (gauge)** block parameter; that of Δp_{Crack} is obtained from the **Cracking pressure differential** block parameter. The maximum pressure, at which the opening area is at its largest, is:

$$p_{\text{Max}} = \begin{cases} p_{\text{Max,G}} + p_{\text{Atm}}, & \text{Pressure at port A method} \\ \Delta p_{\text{Max}}, & \text{Pressure differential method} \end{cases}$$

where subscript **Max** denotes a maximum pressure (obtained as gauge). The value of $p_{\text{Max,G}}$ is obtained from the **Maximum opening pressure (gauge)** block parameter; that of Δp_{Max} is obtained from the **Maximum opening pressure differential** block parameter. The control, cracking, and maximum pressures give for the linear form of the valve opening area:

$$S_{\text{Lin}} = \frac{S_{\text{Max}} - S_{\text{Crack}}}{p_{\text{Max}} - p_{\text{Crack}}}(p_{\text{Ctl}} - p_{\text{Crack}}) + S_{\text{Crack}}$$

where S denotes the (linear) opening area. The opening area at cracking is equal to the small value specified in the **Leakage area** block parameter. The primary purpose of this parameter is to ensure the numerical robustness of the model by ensuring that no portion of a thermal liquid network becomes completely isolated during simulation.

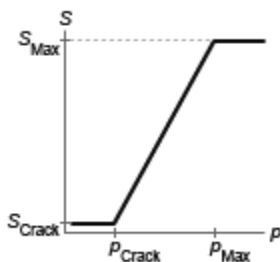

Valve opening area as a linear function of pressure

Leakage Area

The primary purpose of the leakage area of a closed valve is to ensure that at no time does a portion of the hydraulic network become isolated from the remainder of the model. Such isolated portions reduce the numerical robustness of the model and can slow down simulation or cause it to fail. Leakage is generally present in minuscule amounts in real valves but in a model its exact value is less important than it being a small number greater than zero. The leakage area is obtained from the block parameter of the same name.

Opening Area Smoothing

To ensure adequate simulation performance, the valve opening area is smoothed over two small pressure intervals near the specified cracking and maximum pressures. The smoothing is accomplished by means of the polynomial expressions (to be incorporated into the final form of the opening area expression):

$$\lambda_{\text{Crack}} = 3\gamma_{\text{Crack}}^2 - 2\gamma_{\text{Crack}}^3 \quad \text{and} \quad \lambda_{\text{Max}} = 3\gamma_{\text{Max}}^2 - 2\gamma_{\text{Max}}^3,$$

where λ is the smoothing factor applied at the cracking (subscript Crack) and maximum (subscript Max) portions of the surface area expression. The smoothing factor is calculated from the normalized pressure differences γ :

$$\gamma_{\text{Crack}} = \frac{p_{\text{Control}} - p_{\text{Crack}}}{\Delta p_{\text{Smooth}}} \quad \text{and} \quad \gamma_{\text{Max}} = \frac{p_{\text{Crack}} - (p_{\text{Max}} - \Delta p_{\text{Smooth}})}{\Delta p_{\text{Smooth}}},$$

where Δp_{Smooth} is the pressure smoothing region:

$$\Delta p_{\text{Smooth}} = f_{\text{Smooth}} \frac{p_{\text{Max}} - p_{\text{Crack}}}{2}.$$

The parameter f_{Smooth} is a value between 0 and 1 obtained from the **Smoothing factor** block parameter. The final, smoothed, valve opening area is given by the conditional expression:

$$S_{\text{Smooth}} = \begin{cases} S_{\text{Crack}}, & \text{if } p_{\text{Control}} \leq p_{\text{Crack}} \\ S_{\text{Crack}}(1 - \lambda_{\text{Crack}}) + S\lambda_{\text{Crack}}, & \text{if } p_{\text{Control}} \leq p_{\text{Crack}} + \Delta p_{\text{Smooth}} \\ S_{\text{Lin}}, & \text{if } p_{\text{Control}} \leq p_{\text{Max}} - \Delta p_{\text{Smooth}} \\ S_{\text{Lin}}(1 - \lambda_{\text{Max}}) + S_{\text{Max}}\lambda_{\text{Max}}, & \text{if } p_{\text{Control}} \leq p_{\text{Max}} \\ S_{\text{Max}}, & \text{if } p_{\text{Control}} \geq p_{\text{Max}} \end{cases}.$$

Mass Balance

The volume of fluid inside the valve, and therefore the mass of the same, is assumed to be very small and it is, for modeling purposes, ignored. As a result, no amount of fluid can accumulate there. By the principle of conservation of mass, the mass flow rate into the valve through one port must therefore equal that out of the valve through the other port:

$$\dot{m}_A + \dot{m}_B = 0,$$

where \dot{m} is defined as the mass flow rate *into* the valve through one of the ports (**A** or **B**).

Momentum Balance

The causes of those pressure losses incurred in the passages of the valve are ignored in the block. Whatever their natures—sudden area changes, flow passage contortions—only their cumulative effect is considered during simulation. This effect is captured in the block by the discharge coefficient, a measure of the mass flow rate through the valve relative to the theoretical value that it would have in an ideal valve. Expressing the momentum balance in the valve in terms of the pressure drop induced in the flow:

$$p_A - p_B = \frac{\dot{m}_{\text{Avg}} \sqrt{\dot{m}_{\text{Avg}}^2 + \dot{m}_{\text{Crit}}^2}}{2\rho_{\text{Avg}} C_D S_{\text{Smooth}}^2} \left[1 - \left(\frac{S_{\text{Smooth}}}{S_{\text{Lin}}} \right)^2 \right] \xi_p,$$

where C_D is the discharge coefficient, and ξ_p is the pressure drop ratio—a measure of the extent to which the pressure recovery at the outlet contributes to the total pressure drop of the valve. The subscript Avg denotes an average of the values at the thermal liquid ports. The critical mass flow rate \dot{m}_{Crit} is calculated from the critical Reynolds number—that at which the flow in the orifice is assumed to transition from laminar to turbulent:

$$\dot{m}_{\text{Crit}} = \text{Re}_{\text{Crit}} \mu_{\text{Avg}} \sqrt{\frac{\pi}{4} S_{\text{Lin}}}$$

where μ denotes dynamic viscosity. The pressure drop ratio is calculated as:

$$\xi_p = \frac{\sqrt{1 - \left(\frac{S_{\text{Smooth}}}{S_{\text{Lin}}}\right)^2 (1 - C_D^2)} - C_D \frac{S_{\text{Smooth}}}{S_{\text{Lin}}}}{\sqrt{1 - \left(\frac{S_{\text{Smooth}}}{S_{\text{Lin}}}\right)^2 (1 - C_D^2)} + C_D \frac{S_{\text{Smooth}}}{S_{\text{Lin}}}}$$

Energy Balance

The valve is modeled as an adiabatic component. No heat exchange can occur between the fluid and the wall of the valve. No work is done on or by the fluid as it traverses the valve. With these assumptions, energy can enter and exit the valve by advection only, through ports **A** and **B**. By the principle of conservation of energy then, the sum of the energy flows through the ports must always equal zero:

$$\phi_A + \phi_B = 0,$$

where ϕ is defined as the energy flow rate *into* the valve through one of the ports (**A** or **B**).

Ports

Conserving

A — Valve inlet

thermal liquid

Opening through which the flow can enter the valve.

B — Valve outlet

thermal liquid

Opening through which the flow can exit the valve.

Parameters

Pressure control specification — Choice of pressure to use in the block calculations

Pressure at port A (default) | Pressure differential

Choice of pressure to use in the block calculations. The default setting corresponds to the gauge pressure at the valve inlet (port **A**). The alternative setting corresponds to the pressure differential from inlet (**A**) to outlet (**B**).

Cracking pressure (gauge) — Gauge pressure at which the valve begins to open

0.1 MPa (default) | positive scalar in units of pressure

Gauge pressure at port **A** at which the valve begins to open. The valve opening area is saturated at the value of the **Leakage area** block parameter when the pressure at port **A** is at or below the value specified here.

Dependencies

This parameter is active when the **Pressure control specification** block parameter is set to Pressure at port A.

Maximum opening pressure (gauge) — Gauge pressure at which the valve is fully open

0.2 MPa (default) | positive scalar in units of pressure

Gauge pressure at port **A** at which the valve is fully open. The valve opening area is saturated at the value specified in the **Maximum opening area** block parameter when the pressure at port **A** is at or above the value specified here.

Dependencies

This parameter is active when the **Pressure control specification** block parameter is set to Pressure at port A.

Cracking pressure differential — Pressure differential from port A to port B at which the valve begins to open

0.1 MPa (default) | positive scalar in units of pressure

Pressure differential from port A to port B at which the valve begins to open. The valve opening area is saturated at the value of the **Leakage area** block parameter when the pressure differential is at or below the value specified here.

Dependencies

This parameter is active when the **Pressure control specification** block parameter is set to Pressure differential.

Maximum opening pressure differential — Pressure differential from port A to port B at which the valve is fully open

0.2 MPa (default) | positive scalar in units of pressure

Pressure differential from port A to port B at which the valve is fully open. The valve opening area is saturated at the value specified in the **Maximum opening area** block parameter when the pressure differential is at or above the value specified here.

Dependencies

This parameter is active when the **Pressure control specification** block parameter is set to Pressure differential.

Maximum opening area — Opening area of the valve in the fully open position

1e-4 m² (default) | positive scalar in units of area

Opening area of the valve in the fully open position. The valve is fully open if the pressure drop from port **A** to port **B** is equal to or greater than that given by the **Maximum opening pressure** block parameter.

Leakage area — Opening area of the valve in the maximally closed position

1e-10 m² (default) | positive scalar in units of area

Opening area of the valve in the fully closed position, when only internal leakage between its ports remains. This parameter serves primarily to ensure that closure of the valve does not cause portions of the thermal liquid network to become isolated. The exact value specified here is less important than its being a small number greater than zero.

Smoothing factor — Measure of the amount of smoothing to apply to the opening area function

0.01 (default) | positive unitless scalar

Measure of the amount of smoothing to apply to the opening area function. This parameter determines the widths of the regions to be smoothed, one being at the fully open position, the other at the fully closed position. The smoothing superposes on the linear opening area function two nonlinear segments, one for each region of smoothing. The greater the value specified, the greater the smoothing and the broader the nonlinear segments.

Cross-sectional area at ports A and B — Flow area at the thermal liquid ports

0.01 m (default) | positive scalar in units of area

Area normal to the flow path at each port. The ports are assumed to be equal in size. The flow area specified here should match those of the inlets of those components to which the orifice connects.

Characteristic longitudinal length — Measure of the length of the flow path through the valve

0.1 (default) | positive scalar in units of length

Average distance traversed by the fluid as it moves from inlet to outlet. This distance is used in the calculation of the internal thermal conduction that occurs between the two ports (as part of the smoothed upwind energy scheme employed in the thermal liquid domain).

Discharge coefficient — Empirical factor defined as the ratio of actual to ideal mass flow rates

0.7 (default) | positive unitless scalar

Ratio of the actual flow rate through the valve to the theoretical value that it would have in an ideal valve. This semi-empirical parameter measures the flow allowed through the valve: the greater its value, the greater the flow rate. Refer to the valve data sheet, if available, for this parameter.

Critical Reynolds number — Reynolds number at the boundary between laminar and turbulent flow regimes

12 (default) | positive unitless scalar

Reynolds number at which the flow is assumed to transition between laminar and turbulent regimes.

Variables

Mass flow rate into port A — Initial state target for the mass flow rate of the valve

cleared (default) | checked

Desired mass flow rate into the valve through port **A** at the start of simulation. This parameter serves as an initial state target, a guide used by Simscape in assembling the initial configuration of the model. How closely the target is met depends on the constraints imposed by the remainder of the model and on the priority level specified.

Extended Capabilities

C/C++ Code Generation

Generate C and C++ code using Simulink® Coder™.

See Also

Variable Area Orifice (TL) | 2-Way Directional Valve (TL) | 3-Way Directional Valve (TL) | 4-Way Directional Valve (TL)

Introduced in R2016a

Check Valve (2P)

Check valve in a two-phase fluid network

Library: Simscape / Fluids / Two-Phase Fluid / Valves & Orifices / Directional Control Valves



Description

The Check Valve (2P) block models a directional control check valve in a two-phase fluid network. The valve maintains the fluid pressure by opening above a specified pressure and allowing flow from port **A** to port **B**, but not in the reverse direction. The pressure differential that opens the valve is specified in the **Opening pressure specification** parameter. This value can be either the pressure difference between ports **A** and **B** or the gauge pressure at port **A**.

Fluid properties inside the valve are calculated from inlet conditions. There is no heat exchange between the fluid and the environment, and therefore phase change inside the valve only occurs due to a pressure drop or a change propagated from another part of the model.

A number of block parameters are based on nominal operating conditions, which correspond to the valve rated performance, such as a specification on a manufacturer datasheet.

Directional Control

The valve opens when the pressure in the valve, $p_{control}$, exceeds the cracking pressure, p_{crack} . The valve is fully open when the control pressure reaches the valve maximum pressure, p_{max} . The opening fraction of the valve, λ , is expressed as:

$$\lambda = (1 - f_{leak}) \frac{(p_{control} - p_{crack})}{(p_{max} - p_{crack})} + f_{leak},$$

where:

- f_{leak} is the **Closed valve leakage as a fraction of nominal flow**.
- $p_{control}$ is the control pressure, which depends on the **Opening pressure specification** parameter.

When you set **Opening pressure specification** to Pressure differential, the control pressure is $p_A - p_B$.

When you set **Opening pressure specification** to Gauge pressure at port A, the control pressure is the difference between the pressure at port **A** and atmospheric pressure.

The cracking pressure and maximum pressure are specified as either a differential value or a gauge value, depending on the setting of the **Opening pressure specification**. If the control pressure exceeds the maximum pressure, the valve opening fraction is 1.

The mass flow rate depends on the pressure differential, and therefore the open area of the valve. The block calculates this as:

$$\dot{m}_A = \lambda \dot{m}_{nom} \left[\sqrt{\frac{v_{nom}}{2\Delta p_{nom}}} \right] \sqrt{\frac{2}{v_{in} (\Delta p^2 + \Delta p_{lam}^2)^{0.25}}},$$

where:

- Δp is the pressure drop over the valve, $p_A - p_B$.
- Δp_{lam} is the pressure transition threshold between laminar and turbulent flow, which is calculated from the **Laminar flow pressure ratio**, B_{lam} :

$$\Delta p_{lam} = \frac{(p_A + p_B)}{2}(1 - B_{lam}).$$

- \dot{m}_{nom} is the **Nominal mass flow rate at maximum valve opening**.
- Δp_{nom} is the **Nominal pressure drop rate at maximum valve opening**.
- v_{nom} is the nominal inlet specific volume. This value is determined from the fluid properties tabulated data based on the **Nominal inlet specific enthalpy** and **Nominal inlet pressure** parameters.
- v_{in} is the inlet specific volume.

Fluid Specific Volume Dynamics

When the fluid at the valve inlet is a liquid-vapor mixture, the block calculates the specific volume as:

$$v_{in} = (1 - x_{dyn})v_{liq} + x_{dyn}v_{vap},$$

where:

- x_{dyn} is the inlet vapor quality. The block applies a first-order lag to the inlet vapor quality of the mixture.
- v_{liq} is the liquid specific volume of the fluid.
- v_{vap} is the vapor specific volume of the fluid.

If the inlet fluid is liquid or vapor, v_{in} is the respective liquid or vapor specific volume.

Vapor Quality Lag

If the inlet vapor quality is a liquid-vapor mixture, the block applied a first-order time lag:

$$\frac{dx_{dyn}}{dt} = \frac{x_{in} - x_{dyn}}{\tau},$$

where:

- x_{dyn} is the dynamic vapor quality.
- x_{in} is the current inlet vapor quality.
- τ is the **Inlet phase change time constant**.

If the inlet fluid is a subcooled liquid or superheated vapor, x_{dyn} is equal to x_{in} .

Mass Balance

Mass is conserved in the valve:

$$\dot{m}_A + \dot{m}_B = 0,$$

where:

- \dot{m}_A is the mass flow rate at port **A**.
- \dot{m}_B is the mass flow rate at port **B**.

Energy Balance

Energy is conserved in the valve:

$$\Phi_A + \Phi_B = 0,$$

where:

- Φ_A is the energy flow at port **A**.
- Φ_B is the energy flow at port **B**.

Assumptions and Limitations

- The block does not model pressure recovery downstream of the valve.
- There is no heat exchange between the valve and the environment.
- The block does not model choked flow.

Ports

Conserving

A – Fluid port

two-phase fluid

Fluid entry port.

B – Fluid port

two-phase fluid

Fluid exit port.

Parameters

Opening pressure specification – Control pressure

Pressure differential (default) | Gauge pressure at port A

Control pressure specification:

- When set to Pressure differential, the valve opens when $p_A - p_B$ exceeds the **Cracking pressure differential**.
- When set to Gauge pressure at port A, the valve opens when $p_A - p_{atm}$ exceeds the **Cracking pressure (gauge)**.

Cracking pressure differential – Cracking pressure

0.01 MPa (default) | positive scalar

Valve pressure threshold. When the control pressure, $p_A - p_B$, exceeds the opening pressure, the valve begins to open.

Dependencies

To enable this parameter, set **Opening pressure specification** to Pressure differential.

Cracking pressure (gauge) – Cracking pressure

0.1 MPa (default) | positive scalar

Valve pressure threshold. When the control pressure, $p_A - p_{atm}$, exceeds the opening pressure, the valve begins to open.

Dependencies

To enable this parameter, set **Opening pressure specification** to Gauge pressure at port A.

Maximum opening pressure differential – Maximum valve operational pressure

0.1 MPa (default) | positive scalar

Maximum valve operational pressure. The valve begins to open at the cracking pressure value, and is fully open at p_{max} .

Dependencies

To enable this parameter, set **Opening pressure specification** to Pressure differential.

Maximum opening pressure (gauge) – Pressure that fully opens the valve

0.2 MPa (default) | positive scalar

Valve operational pressure at which the valve is fully open. The valve begins to open at the cracking pressure value, and is fully open at p_{max} .

Dependencies

To enable this parameter, set **Opening pressure specification** to Gauge pressure at port A.

Nominal mass flow rate at maximum opening – Rated mass flow rate

0.1 kg/s (default) | positive scalar

Mass flow rate through a fully open valve under typical, design, or rated conditions.

Nominal pressure drop at maximum opening – Rated pressure drop

0.001 MPa (default) | positive scalar

Pressure drop over a fully open valve under typical, design, or rated conditions.

Nominal inlet condition specification – Method of determining inlet fluid state

Temperature (default) | Vapor quality | Vapor void fraction | Specific enthalpy | Specific internal energy

Method of determining inlet fluid state. The valve inlet specific volume is determined from the fluid properties tabulated data based on the **Nominal inlet pressure** and the setting of the **Nominal inlet condition specification** parameters.

Nominal inlet pressure – Pressure of fluid entering valve

0.101325 MPa (default) | positive scalar

Valve inlet pressure in typical, design, or rated conditions. The valve inlet specific volume is determined from the fluid properties tabulated data based on the **Nominal inlet pressure** and the setting of the **Nominal inlet condition specification** parameters.

Nominal inlet temperature – Fluid temperature

293.15 K (default) | positive scalar

Inlet fluid temperature in nominal operating conditions.

Dependencies

To enable this parameter, set **Nominal inlet condition specification** to Temperature.

Nominal inlet vapor quality – Inlet vapor quality by mass fraction

0.5 (default) | positive scalar in the range [0,1]

Inlet vapor quality of the mixture by mass fraction in nominal operating conditions. A value of 0 means that the inlet fluid is subcooled liquid. A value of 1 means that the inlet fluid is superheated vapor.

Dependencies

To enable this parameter, set **Nominal inlet condition specification** to Vapor quality.

Nominal inlet vapor void fraction – Inlet volume fraction

0.5 (default) | positive scalar in the range [0,1]

Inlet mixture volume fraction in nominal operating conditions. A value of 0 means that the inlet fluid is subcooled liquid. A value of 1 means that the inlet fluid is superheated vapor.

Dependencies

To enable this parameter, set **Nominal inlet condition specification** to Vapor void fraction.

Nominal inlet specific enthalpy – Inlet fluid specific enthalpy

1500 kJ/kg (default) | positive scalar

Inlet specific enthalpy in nominal operating conditions.

Dependencies

To enable this parameter, set **Nominal inlet condition specification** to Specific enthalpy.

Nominal inlet specific internal energy – Inlet specific internal energy

1500 kJ/kg (default) | positive scalar

Inlet specific internal energy in nominal operating conditions.

Dependencies

To enable this parameter, set **Nominal inlet condition specification** to Specific internal energy.

Cross-sectional area at ports A and B – Valve port areas

0.01 m² (default) | positive scalar

Area of the valve ports **A** and **B**.

Closed valve leakage as a fraction of nominal flow — Fractional flow when valve is closed

1e-6 (default) | positive scalar

Fractional flow rate through the valve when it is fully closed. This parameter contributes to numerical stability by maintaining continuity in the fluid network.

Smoothing factor — Numerical smoothing factor

0.01 (default) | positive scalar in the range [0,1]

Continuous smoothing factor that introduces a layer of gradual change to the flow response when the valve is in near-open or near-closed positions. Set this parameter to a nonzero value less than one to increase the stability of your simulation in these regimes.

Laminar flow pressure ratio — Laminar-turbulent transition pressure ratio

0.999 (default) | positive scalar

Ratio of the valve outlet pressure to valve inlet pressure at which the fluid transitions between the laminar and turbulent regimes. The pressure loss corresponds to the mass flow rate linearly in laminar flows and quadratically in turbulent flows.

Inlet phase change time constant — Lag for mixture specific volume

0.1 s (default) | positive scalar

Time lag for liquid-vapor mixtures in computing the fluid specific volume. This parameter does not influence the specific volume when the inlet fluid is a fully supercooled liquid or fully superheated vapor.

See Also

Orifice (2P) | Pressure-Reducing Valve (2P) | Pressure Relief Valve (2P) | Thermostatic Expansion Valve (2P)

Introduced in R2021a

Compressor (G)

Gas compressor in a thermodynamic cycle

Library: Simscape / Fluids / Gas / Turbomachinery



Description

The Compressor (G) block models a dynamic compressor, such as a centrifugal or axial compressor, in a gas network. You can parameterize the block analytically or by a tabulated compressor map. Fluid flowing from port **A** to port **B** generates torque. Port **R** reports shaft torque and angular velocity relative to port **C**, which is associated with the compressor casing.

In the tabulated data parameterization, the *surge margin*, the ratio between the surge pressure ratio at a given mass flow rate and the operating point pressure ratio minus 1, is output at port **SM**.

The compressor *design point* is the intended operational pressure ratio over and mass flow rate through the compressor during simulation. The compressor operating point and the point of maximum efficiency do not need to coincide.

Compressor Map

A compressor map depicts compressor performance as a function of pressure ratio, the compressor outlet pressure to the inlet pressure, and corrected mass flow rate. The map plots the isentropic efficiency of the compressor between the two extremes of choked flow and surge flow. Compressor maps use β lines to assess performance at an interval across shaft speeds. Choked flow corresponds to $\beta = 0$ and surge flow corresponds to $\beta = 1$. β lines are perpendicular to the compressor shaft constant speed lines, N , which are also corrected for pressure and temperature changes in the compressor.

Corrected Mass Flow Rate

Due to the large changes in pressure and temperature inside a compressor, the compressor map plots performance in terms of a corrected mass flow rate. The corrected mass flow rate is adjusted from the inlet mass flow rate with a corrected pressure and corrected temperature:

$$\dot{m}_A \sqrt{\frac{T_A}{T_{corr}}} = \dot{m}_{corr} \frac{p_A}{p_{corr}},$$

where:

- \dot{m}_A is the mass flow rate at port **A**.
- T_A is the temperature at port **A**.
- T_{corr} is the **Reference temperature for corrected flow**. When using a tabulated compressor map, the data supplier specifies this value. When using the analytical parameterization, this is the temperature at which the pressure ratio–mass flow rate relationship over a range of temperatures converges to a single trend line.
- \dot{m}_{corr} is the corrected mass flow rate.

When **Parameterization** is set to Analytical, this is the **Corrected mass flow rate at design point**.

When **Parameterization** is set to Tabulated, this is derived from the **Corrected mass flow rate table, $\dot{m}(N,\beta)$** .

- p_A is the pressure at port **A**.
- p_{corr} is the **Reference pressure for corrected flow**. When using a tabulated compressor map, the data supplier specifies this value. When using the analytical parameterization, this is the pressure at which the pressure ratio–mass flow rate relationship over a range of pressures converges to a single trend line.

Shaft Torque

The shaft torque, τ , is calculated as:

$$\tau = \frac{\dot{m}_A \Delta h_{total}}{\eta_m \omega},$$

where:

- Δh_{total} is the total change in the fluid specific enthalpy.
- η_m is the compressor **Mechanical efficiency**.
- ω is the relative shaft angular velocity, $\omega_R - \omega_C$.

Reversed flow, from **B** to **A**, is outside of the typical compressor operation mode and accurate results should not be expected. A threshold region when flow approaches zero ensures that no torque is generated when the flow rate is near zero or reversed.

Analytical Parameterization

If you do not have tabulated compressor data available, you can model the compressor pressure ratio, corrected mass flow rate, and isentropic efficiency analytically. The analytical method does not use β lines and the block does not report a surge margin.

Pressure Ratio

The pressure ratio at a given shaft speed and mass flow rate is calculated as:

$$\pi = 1 + (\pi_D - 1) \left[\tilde{N}^{ab} + 2\tilde{N}k \ln \left(1 - \frac{\tilde{m} - \tilde{N}^b}{k} \right) \right],$$

where:

- π_D is the **Pressure ratio at design point**.
- \tilde{N} is the normalized corrected shaft speed,

$$\frac{N}{N_D},$$

where N_D is the **Corrected speed at design point**.

- \tilde{m} is the normalized corrected mass flow rate,

$$\frac{\dot{m}_{corr}}{\dot{m}_D},$$

where \dot{m}_D is the **Corrected mass flow rate at design point**.

- a is the **Spine shape, a**.
- b is the **Speed line spread, b**.
- k is the **Speed line roundness, k**.

The map *spine* refers to the analytical line denoting the nominal compressor performance. The map *speed lines* are the shaft constant-speed lines that intersect the spine perpendicularly. The spine and speed line variables are tunable parameters that can be adjusted for different performance characteristics.

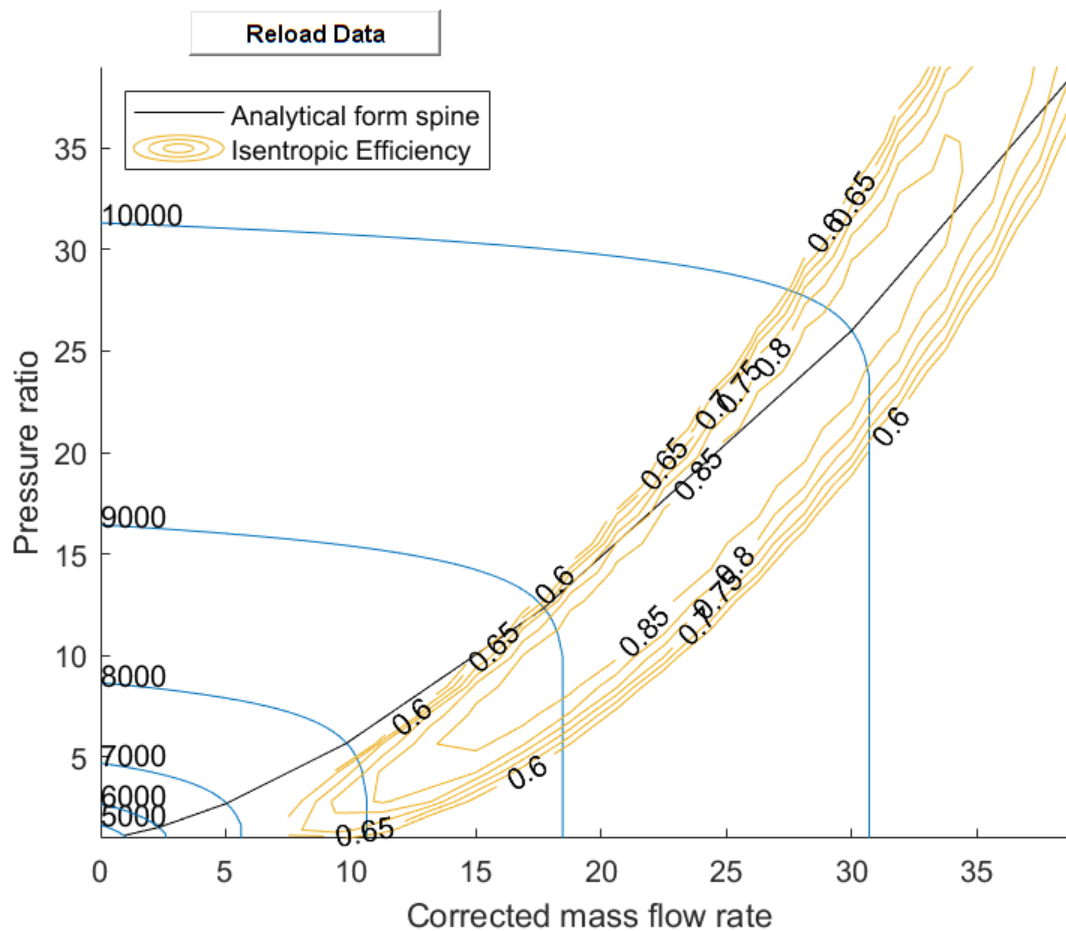

Analytical Parameterization Default Compressor Map

Isentropic Efficiency Parameterization

When **Efficiency specification** is set to Analytical, the block models variable compressor efficiency as:

$$\eta = \eta_0 \left(1 - C \left| \frac{\tilde{p}}{\tilde{m}^{a+\Delta a-1}} - \tilde{m} \right|^c - D \left| \frac{\tilde{m}}{\tilde{m}_0} - 1 \right|^d \right),$$

where:

- η_0 is the **Maximum isentropic efficiency**.
- C is the **Efficiency contour gradient orthogonal to spine, C**.
- D is the **Efficiency contour gradient along spine, D**.
- c is the **Efficiency peak flatness orthogonal to spine, c**.
- d is the **Efficiency peak flatness along spine, d**.
- \tilde{p} is the normalized corrected pressure ratio,

$$\frac{\pi - 1}{\pi_D - 1}$$

where π_D is the **Corrected pressure ratio at design point**.

- \tilde{m}_0 is the normalized corrected mass flow rate at which the compressor reaches its **Maximum isentropic efficiency**.

The efficiency variables are tunable parameters that you can adjust for different performance characteristics. a measures the relationship between the operating point and the point of maximum efficiency. When $\Delta a = 0$, the compressor operates at the point of maximum efficiency.

Alternatively, you can model constant efficiency by assigning a **Constant efficiency value**.

Tabulated Data Parameterization

When **Parameterization** is set to **Tabulated**, the compressor isentropic efficiency, pressure ratio, and corrected mass flow rate are a function of the corrected speed, N , and the map index, β . The block uses linear interpolation between data points for the efficiency, pressure ratio, and corrected mass flow rate parameters.

If the simulation conditions exceed $\beta = 1$, surge flow is modeled: the pressure ratio remains at its value at $\beta = 1$, while the mass flow rate continues to change. If the simulation conditions fall below $\beta = 0$, choked flow is modeled: the mass flow rate remains at its value at $\beta = 0$, while the pressure ratio continues to change. To constrain the compressor performance within the map boundaries, the block extrapolates isentropic efficiency to the nearest point.

You can choose to be notified when the operating point pressure ratio exceeds the surge pressure ratio. Set **Report when static margin is negative** to **Warning** to receive a warning or to **Error** to stop the simulation when this occurs.

Visualizing the Block Compressor Map

To visualize the block map, right-click the block and select **Fluids > Plot Compressor Map Characteristics**.

Each time you modify the block settings, click **Apply** at the bottom of the dialog box, then click **Reload Data** on the figure window.

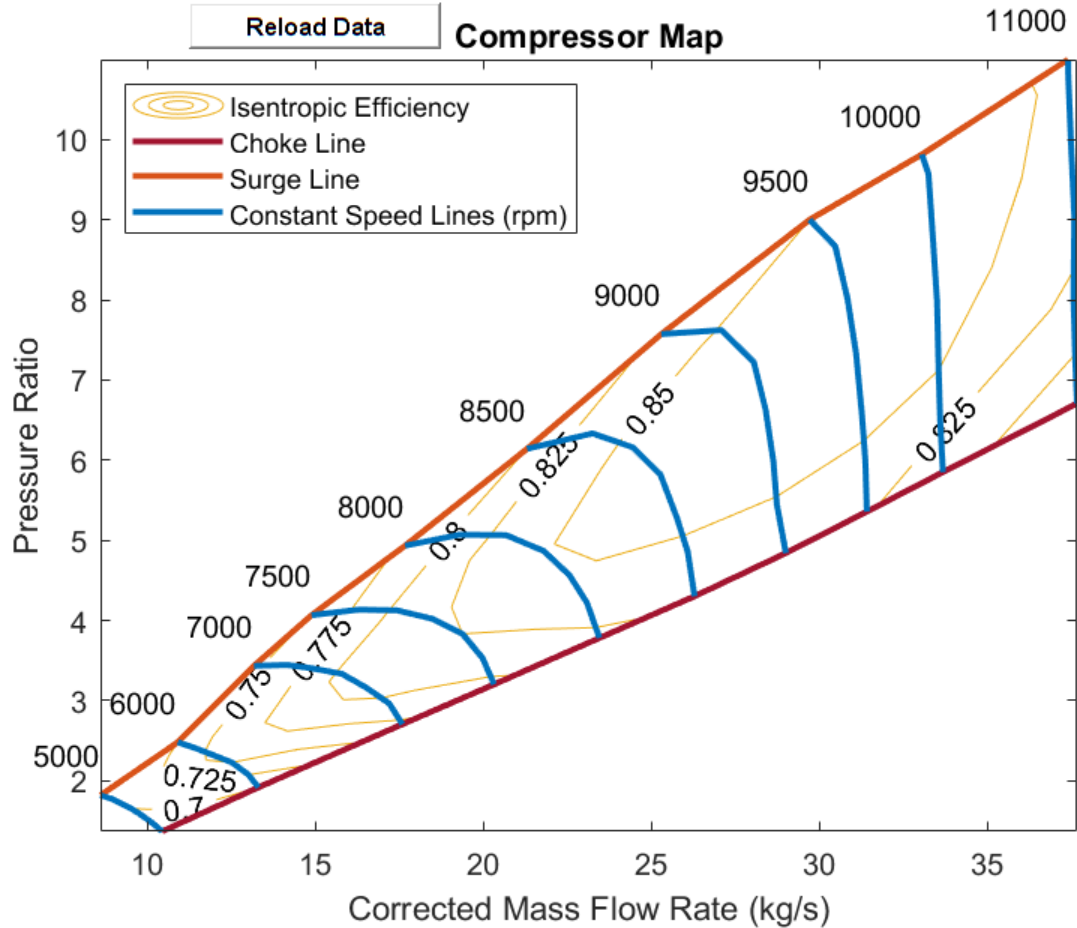

Tabulated Parameterization Default Compressor Map

Continuity Equations

Mass is preserved over the block:

$$\dot{m}_A + \dot{m}_B = 0,$$

where \dot{m}_B is the mass flow rate at port **B**.

The energy balance in the block is calculated as:

$$\Phi_A + \Phi_B + P_{fluid} = 0,$$

where:

- Φ_A is the energy flow rate at port **A**.
- Φ_B is the energy flow rate at port **B**.
- P_{fluid} is the hydraulic power delivered to the fluid, which is determined from the change in total fluid specific enthalpy: $P_{fluid} = \dot{m}_A \Delta h_{total}$.

Assumptions and Limitations

- The shaft does not rotate under reversed flow conditions. Results during reversed flows may not be accurate.
- The block only models dynamic compressors.
- Successful simulation initialization requires a moderately accurate pressure input.

Ports

Conserving

A — Gas inlet

gas

Fluid entry port.

B — Gas outlet

gas

Fluid exit port.

C — Compressor casing

mechanical translational

Port associated with the compressor casing.

R — Compressor shaft

mechanical translational

Port associated with the compressor shaft torque and angular velocity.

Output

SM — Surge margin

physical signal

Outputs the compressor surge margin, the ratio between the operating point pressure ratio and the surge pressure ratio, at a given mass flow rate:

$$SM(\dot{m}_{corr}) = \frac{p_{r, surge}(\dot{m}_{corr})}{p_r(\dot{m}_{corr})} - 1.$$

Dependencies

To enable this port, set **Parameterization** to Tabulated.

Parameters

Compressor Map

Parameterization — Compressor performance model

Analytical (default) | Tabulated

Compressor performance model. You can choose either:

- **Analytical:** A pressure ratio-corrected mass flow rate curve defines peak compressor performance. You can choose to model isentropic efficiency as a constant or analytically.
- **Tabulated:** A user-supplied compressor map defines the compressor performance. The compressor operating points are determined by linear interpolation between the corrected mass flow rate, pressure ratio, and isentropic efficiency tables at given points in the user-provided corrected shaft speed and β vectors. The default map comes from data reported in [3].

Corrected speed at design point – Operational corrected shaft speed

10000 rpm (default) | positive scalar

Shaft speed at the intended compressor pressure ratio and corrected mass flow rate, corrected for pressure and temperature.

Dependencies

To enable this parameter, set **Parameterization** to Analytical.

Pressure ratio at design point – Operational outlet-to-inlet pressure ratio

26 (default) | positive scalar

Outlet-to-inlet pressure ratio at the intended compressor corrected mass flow rate.

Dependencies

To enable this parameter, set **Parameterization** to Analytical.

Corrected mass flow rate at design point – Operational corrected mass flow rate

30 kg/s (default) | positive scalar

Mass flow rate at the intended compressor pressure ratio, corrected for temperature and pressure.

Dependencies

To enable this parameter, set **Parameterization** to Analytical.

Efficiency specification – Isentropic efficiency model

Analytical (default) | Constant

Isentropic efficiency model type. Choose a constant or variable (analytical) model.

Dependencies

To enable this parameter, set **Parameterization** to Analytical.

Maximum isentropic efficiency – Maximum compressor efficiency

0.887 (default) | positive scalar in the range (0,1]

Maximum compressor isentropic efficiency. Isentropic efficiency is the ratio of the change in total specific enthalpy to the change in total specific isentropic enthalpy.

Dependencies

To enable this parameter, set **Parameterization** to Analytical and **Efficiency specification** to Analytical.

Corrected mass flow rate at maximum efficiency point – Corrected mass flow rate at compressor maximum efficiency

24 kg/s (default) | positive scalar

Mass flow rate at maximum efficiency, corrected for temperature and pressure. The point of maximum efficiency does not necessarily coincide with the compressor design point in your simulation.

Dependencies

To enable this parameter, set **Parameterization** to Analytical and **Efficiency specification** to Analytical.

Pressure ratio at maximum efficiency point — Pressure ratio at compressor maximum efficiency

17 (default) | positive scalar

Pressure ratio at maximum efficiency. The point of maximum efficiency does not necessarily coincide with the compressor design point in your simulation.

Dependencies

To enable this parameter, set **Parameterization** to Analytical and **Efficiency specification** to Analytical.

Constant efficiency value — Constant isentropic efficiency value

0.8 (default) | positive scalar in the range (0,1]

Value of constant isentropic efficiency in the analytical parameterization.

Dependencies

To enable this parameter, set **Parameterization** to Analytical and **Efficiency specification** to Constant.

Corrected speed index vector, N — Vector of corrected shaft speeds

100 .* [50, 60, 70, 75, 80, 85, 90, 95, 100, 110] rpm (default) | vector

Vector of corrected shaft speeds.

Dependencies

To enable this parameter, set **Parameterization** to Tabulated.

Beta index vector, beta — Vector of intervals

0 : 1 / 6 : 1 (default) | vector of elements in the range [0,1]

Vector of intervals between 0 and 1 at which to assess compressor performance. Choked flow is defined as $\beta = 0$ and surge flow is defined at $\beta = 1$. β lines are perpendicular to the compressor shaft constant speed lines, N .

Dependencies

To enable this parameter, set **Parameterization** to Tabulated.

Pressure ratio table, pr(N,beta) — Compressor map pressure ratio data

[1.369, 1.459, 1.587, 1.654, 1.734, 1.775, 1.82; 1.918, 2.075, 2.229, 2.318, 2.405, 2.456, 2.481; 2.706, 2.966, 3.168, 3.334, 3.404, 3.445, 3.435; 3.203, 3.533, 3.833, 4.021, 4.127, 4.135, 4.066; 3.782, 4.222, 4.565, 4.867, 5.065, 5.07, 4.934; 4.302, 4.861, 5.285, 5.821, 6.161, 6.334, 6.142; 4.841, 5.445, 5.988, 6.628, 7.222, 7.623, 7.573; 5.358, 5.997, 6.589, 7.334, 8.012, 8.668,

9; 5.851, 6.491, 7.124, 7.982, 8.754, 9.57, 9.814; 6.707, 7.321, 8.034, 9.047, 9.94, 10.834, 10.998] (default) | *M*-by-*N* matrix

M-by-*N* matrix of compressor outlet-to-inlet pressure ratios at the specified corrected shaft speed and β value. Linear interpolation is employed between table elements. *M* and *N* are the sizes of the corresponding vectors:

- *M* is the number of vector elements in the **Corrected speed index vector**, **N** parameter.
- *N* is the number of vector elements in the **Beta index vector**, **beta** parameter.

Dependencies

To enable this parameter, set **Parameterization** to Tabulated.

Corrected mass flow rate table, $\dot{m}(N, \beta)$ – Compressor map corrected mass flow rate data

[10.45, 10.203, 9.784, 9.526, 9.144, 8.947, 8.615; 13.315, 13.018, 12.525, 11.984, 11.455, 11.086, 10.914; 17.601, 17.204, 16.502, 15.8, 14.903, 14.179, 13.184; 20.331, 19.983, 19.39, 18.492, 17.435, 16.293, 14.895; 23.466, 23.092, 22.572, 21.807, 20.687, 19.3, 17.682; 26.295, 26.091, 25.766, 25.28, 24.453, 23.26, 21.311; 29.013, 28.747, 28.641, 28.412, 28.06, 27.098, 25.306; 31.424, 31.379, 31.273, 31.103, 30.849, 30.484, 29.718; 33.688, 33.606, 33.561, 33.513, 33.392, 33.258, 33.059; 37.678, 37.621, 37.575, 37.598, 37.501, 37.415, 37.413] (default) | *M*-by-*N* matrix

M-by-*N* matrix of corrected mass flow rates at the specified corrected shaft speed and β value. Linear interpolation is employed between table elements. *M* and *N* are the sizes of the corresponding vectors:

- *M* is the number of vector elements in the **Corrected speed index vector**, **N** parameter.
- *N* is the number of vector elements in the **Beta index vector**, **beta** parameter.

Dependencies

To enable this parameter, set **Parameterization** to Tabulated.

Isentropic efficiency table, $\eta(N, \beta)$ – Compressor map isentropic efficiency data

[.68, .69, .695, .7, .701, .705, .704; .7, .725, .75, .755, .745, .73, .725; .77, .795, .81, .805, .78, .765, .745; .795, .812, .825, .82, .805, .78, .75; .82, .837, .848, .849, .835, .805, .78; .83, .845, .856, .86, .855, .84, .8; .83, .848, .859, .869, .86, .852, .83; .828, .845, .857, .869, .862, .855, .85; .806, .83, .85, .86, .859, .857, .853; .79, .8, .82, .835, .845, .848, .849] (default) | *M*-by-*N* matrix

M-by-*N* matrix of compressor isentropic efficiencies at the specified corrected shaft speed and β value. Linear interpolation is employed between table elements. *M* and *N* are the sizes of the corresponding vectors:

- *M* is the number of vector elements in the **Corrected speed index vector**, **N** parameter.
- *N* is the number of vector elements in the **Beta index vector**, **beta** parameter.

Dependencies

To enable this parameter, set **Parameterization** to Tabulated.

Report when static margin is negative – Whether to notify if pressure ratio exceeds surge pressure ratio

None (default) | Warning | Error

Whether to notify if the compressor operating point pressure ratio exceeds the surge pressure ratio at the given corrected mass flow rate.

Dependencies

To enable this parameter, set **Parameterization** to Tabulated.

Map Coefficients

To enable this tab, set **Parameterization** to Analytical.

Spine shape, a – Spine shape exponent

1.5 (default) | positive scalar

Exponent in the analytical parameterization of the pressure ratio that characterizes the spine shape.

Dependencies

To enable this parameter, set **Parameterization** to Analytical.

Speed line spread, b – Constant speed line spacing exponent

5 (default) | positive scalar

Exponent in the analytical parameterization of the pressure ratio that characterizes the constant speed line spacing.

Dependencies

To enable this parameter, set **Parameterization** to Analytical.

Speed line roundness, k – Constant speed line shape coefficient

0.03 (default) | positive scalar

Coefficient in the analytical parameterization of the pressure ratio that characterizes the constant speed line shape.

Dependencies

To enable this parameter, set **Parameterization** to Analytical.

Efficiency peak flatness orthogonal to spine, c – Exponent characterizing shape of analytical isentropic efficiency

3 (default) | positive scalar

Exponent in the analytical efficiency model that characterizes the efficiency curve shape.

Dependencies

To enable this parameter, set **Parameterization** to Analytical and **Efficiency specification** to Analytical.

Efficiency peak flatness along spine, d – Exponent characterizing shape of analytical isentropic efficiency

4 (default) | positive scalar

Exponent in the analytical efficiency model.

Dependencies

To enable this parameter, set **Parameterization** to `Analytical` and **Efficiency specification** to `Analytical`.

Efficiency contour gradient orthogonal to spine, C – Coefficient characterizing shape of analytical isentropic efficiency

15 (default) | positive scalar

Coefficient in the analytical efficiency model.

Dependencies

To enable this parameter, set **Parameterization** to `Analytical` and **Efficiency specification** to `Analytical`.

Efficiency contour gradient along spine, D – Coefficient characterizing shape of analytical isentropic efficiency

1.0 (default) | positive scalar in the range (0,1]

Coefficient in the analytical efficiency model.

Dependencies

To enable this parameter, set **Parameterization** to `Analytical` and **Efficiency specification** to `Analytical`.

Reference Data**Reference pressure for corrected flow – Correcting pressure**

0.101325 MPa (default) | positive scalar

Pressure at which compressor data consolidates to a corrected trend line. When **Parameterization** is set to `Tabulated`, the data supplier specifies this value. When **Parameterization** is set to `Analytical`, this is the pressure at which the pressure ratio-mass flow rate relationship over a range of pressures converges to a single trend line.

Reference temperature for corrected flow – Correcting temperature

288.15 K (default) | positive scalar

Temperature at which compressor data becomes consolidated to a corrected trend line. When **Parameterization** is set to `Tabulated`, the data supplier specifies this value. When **Parameterization** is set to `Analytical`, this is the temperature at which the pressure ratio-mass flow rate relationship over a range of temperatures converges to a single trend line.

Mechanical efficiency – Efficiency of conversion to torque

0.9 (default) | positive scalar in the range [0,1]

Efficiency of conversion from gain in specific enthalpy to shaft torque.

Inlet area at port A – Compressor inlet area

1 m² (default) | positive scalar

Compressor inlet cross-sectional area.

Outlet area at port B – Compressor outlet area

1 m² (default) | positive scalar

Compressor outlet cross-sectional area.

References

- [1] Greitzer, E. M. et al. "N+3 Aircraft Concept Designs and Trade Studies. Volume 2: Appendices - Design Methodologies for Aerodynamics, Structures, Weight, and Thermodynamic Cycles." *NASA Technical Report*, 2010.
- [2] Kurzke, Joachim. "How to Get Component Maps for Aircraft Gas Turbine Performance Calculations." *Volume 5: Manufacturing Materials and Metallurgy; Ceramics; Structures and Dynamics; Controls, Diagnostics and Instrumentation; Education; General*, American Society of Mechanical Engineers, 1996, p. V005T16A001.
- [3] Plencner, Robert M. "Plotting component maps in the Navy/NASA Engine Program (NNEP): A method and its usage." *NASA Technical Memorandum*, 1989.

See Also

Thermostatic Expansion Valve (2P) | Turbine (G)

Introduced in R2021a

Condenser Evaporator (2P-MA)

Models heat exchange between a moist air network and a network that can undergo phase change

Library: Simscape / Fluids / Fluid Network Interfaces / Heat Exchangers



Description

The Condenser Evaporator (2P-MA) block models a heat exchanger with one moist air network, which flows between ports **A2** and **B2**, and one two-phase fluid network, which flows between ports **A1** and **B1**. The heat exchanger can act as a condenser or as an evaporator. The fluid streams can be aligned in parallel, counter, or cross-flow configurations.

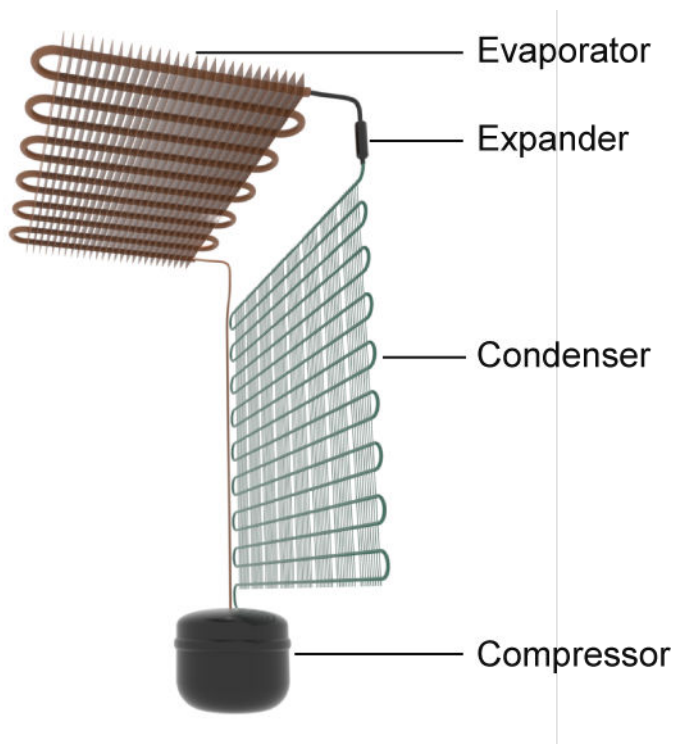

Example Heat Exchanger for Refrigeration Applications

You can model the moist air side as flow within tubes, flow around the two-phase fluid tubing, or by an empirical, generic parameterization. The moist air side comprises air, trace gas, and water vapor that may condense throughout the heat exchange cycle. The block model accounts for energy transfer from the air to the liquid water condensation layer. This liquid layer does not collect on the heat

transfer surface and is assumed to be completely removed from the downstream moist air flow. The moisture condensation rate is returned as a physical signal at port **W**.

The block uses the Effectiveness-NTU (E-NTU) method to model heat transfer through the shared wall. Fouling on the exchanger walls, which increases thermal resistance and reduces the heat exchange between the two fluids, is also modeled. You can also optionally model fins on both the moist air and two-phase fluid sides. Pressure loss due to viscous friction on both sides of the exchanger can be modeled analytically or by generic parameterization, which you can use to tune to your own data.

You can model the two-phase fluid side as flow within a tube or a set of tubes. The two-phase fluid tubes use a boundary-following model to track the sub-cooled liquid (L), vapor-liquid mixture (M), and super-heated vapor (V) in three zones. The relative amount of space a zone occupies in the system is called a *zone length fraction* within the system.

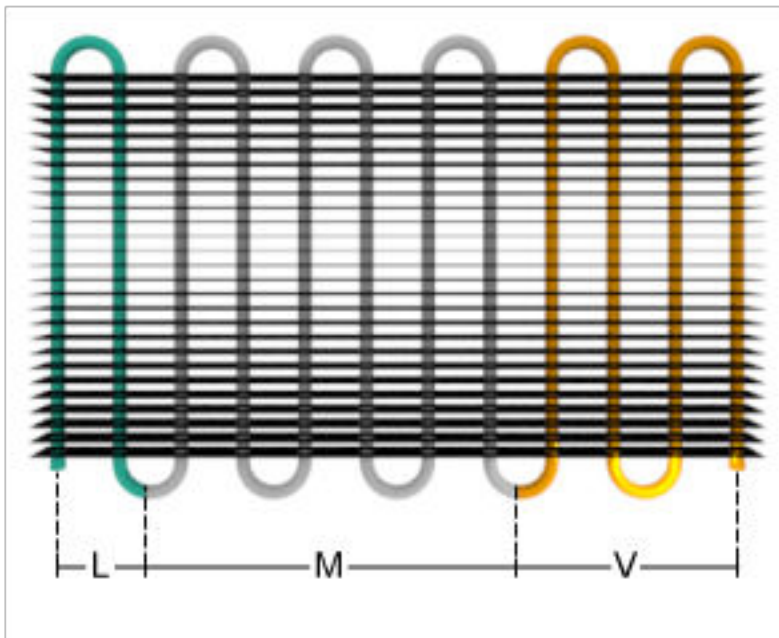

Zone Length Fractions in the Two-Phase Fluid Piping

The sum of the zone length fractions in the two-phase fluid tubing equals 1. Port **Z** returns the zone length fractions as a vector of physical signals for each of the three phases: [L, M, V].

Heat Exchanger Configuration

The heat exchanger effectiveness is based on the selected heat exchanger configuration, the fluid properties in each phase, the tube geometry and flow configuration on each side of the exchanger, and the usage and size of fins.

Flow Arrangement

The **Flow arrangement** parameter assigns the relative flow paths between the two sides:

- Parallel flow indicates the fluids are moving in the same direction.
- Counter flow indicates the fluids are moving in parallel, but opposite directions.
- Cross flow indicates the fluids are moving perpendicular to each other.

Thermal Mixing

When **Flow arrangement** is set to Cross flow, use the **Cross flow arrangement** parameter to indicate whether the two-phase fluid or moist air flows are separated into multiple paths by baffles or walls. Without these separations, the flow can mix freely and is considered *mixed*. Both fluids, one fluid, or neither fluid can be mixed in the cross-flow arrangement. Mixing homogenizes the fluid temperature along the direction of flow of the second fluid, and varies perpendicular to the second fluid flow.

Unmixed flows vary in temperature both along and perpendicular to the flow path of the second fluid.

Sample Cross-Flow Configurations

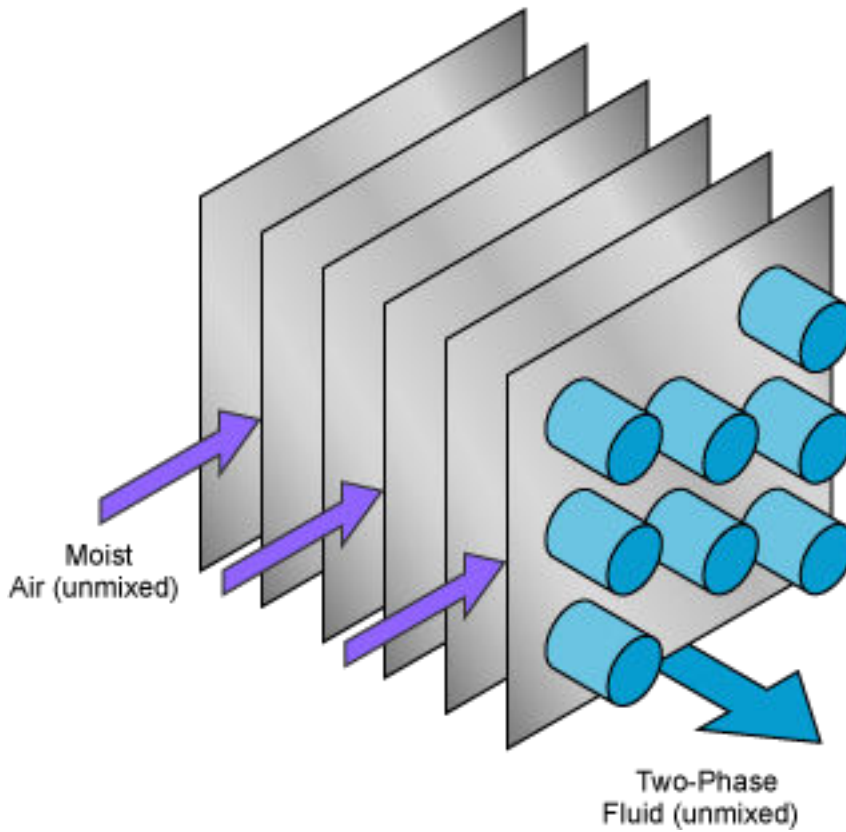
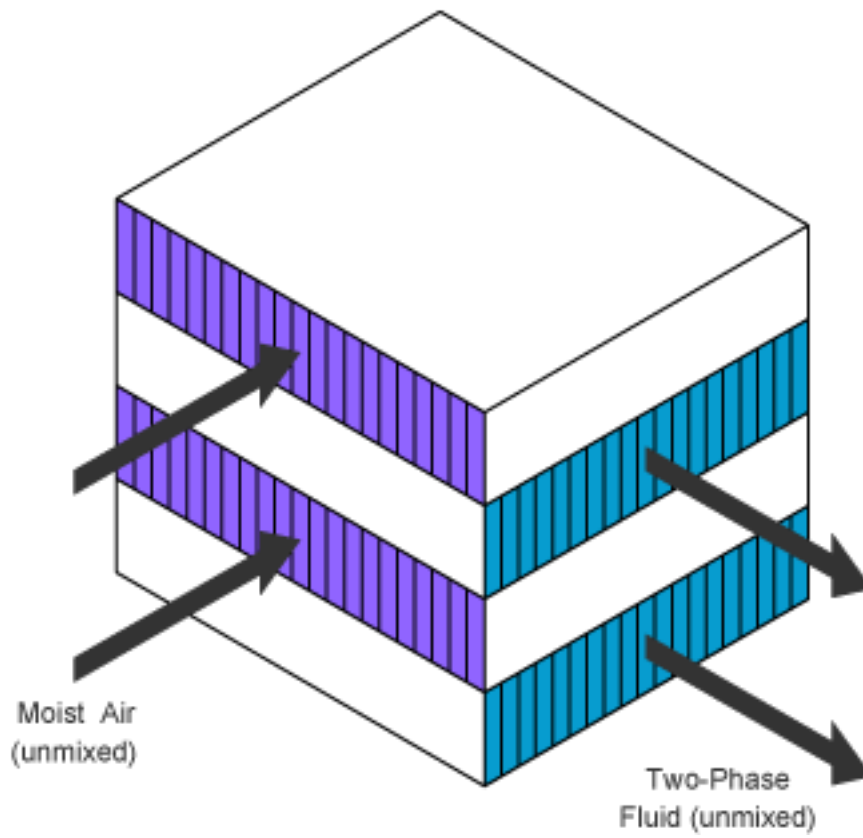

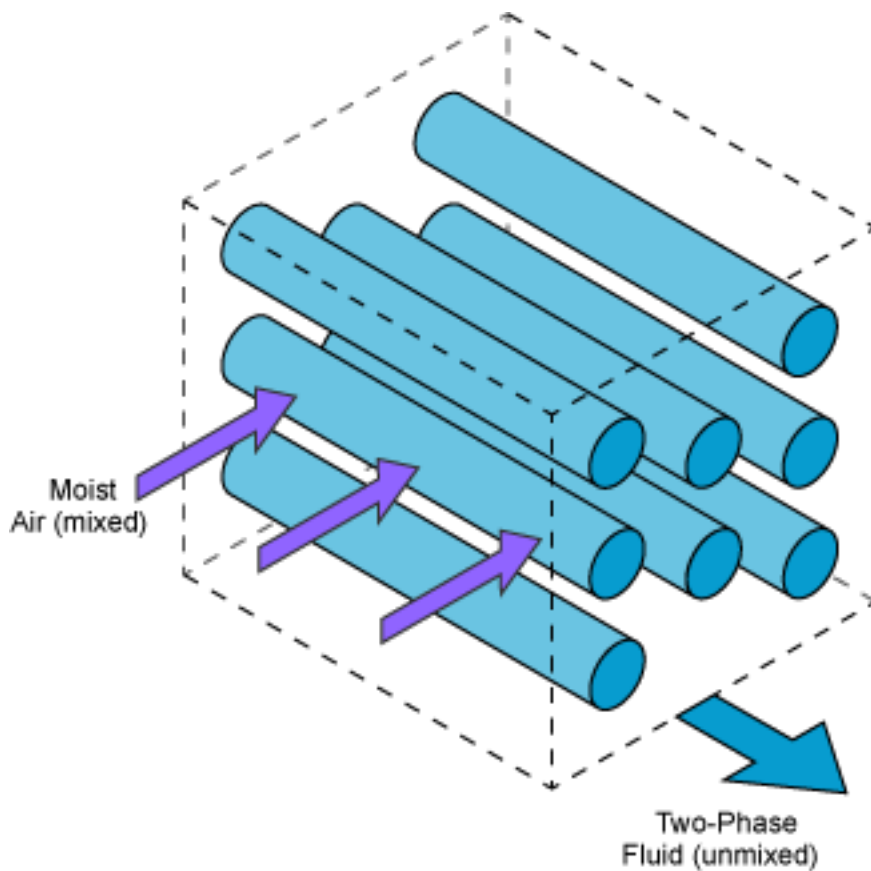

Note that the flow direction during simulation does not impact the selected flow arrangement setting. The ports on the block do not reflect the physical positions of the ports in the physical heat exchange system.

All flow arrangements are single-pass, which means that the fluids do not make multiple turns in the exchanger for additional points of heat transfer. To model a multi-pass heat exchanger, you can arrange multiple Condenser Evaporator (2P-MA) blocks in series or in parallel.

For example, to achieve a two-pass configuration on the two-phase fluid side and a single-pass configuration on the moist air side, you can connect the two-phase fluid sides in series and the moist air sides to the same input in parallel (such as two Mass Flow Rate Source blocks with half of the total mass flow rate), as shown below.

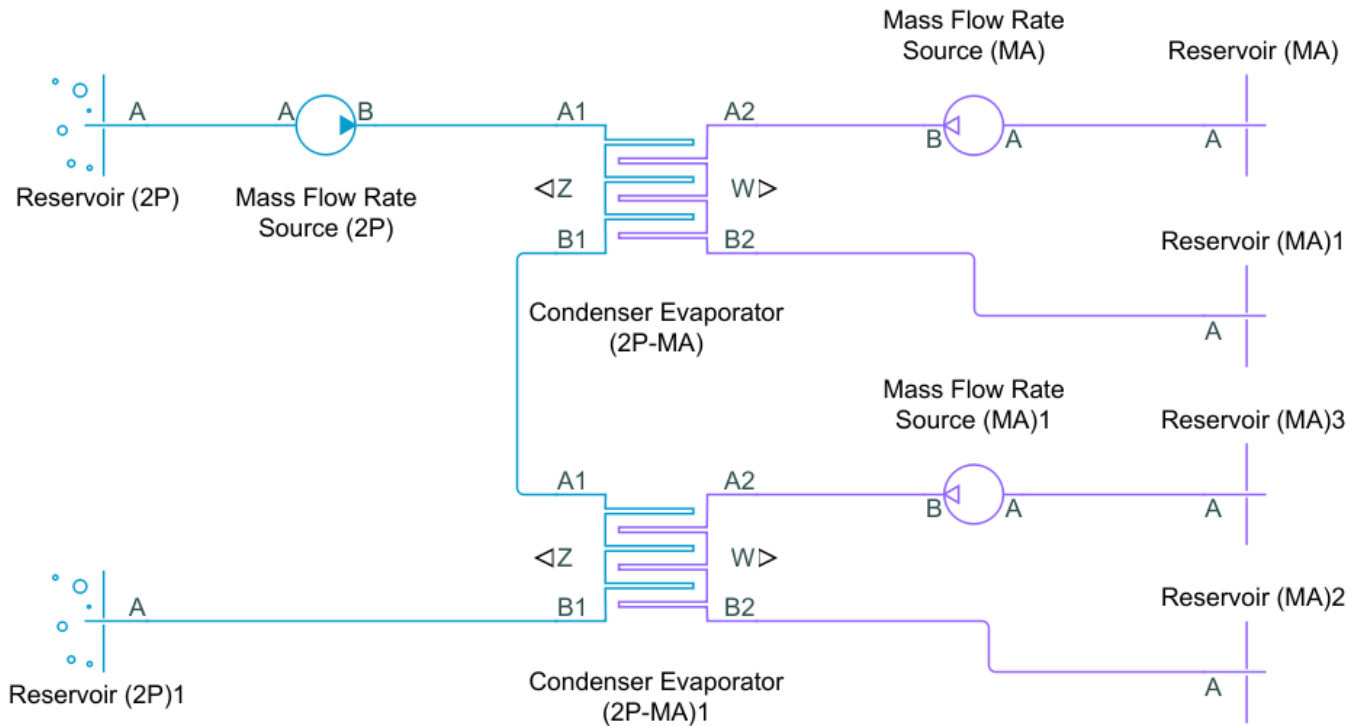

Flow Geometry

The **Flow geometry** parameter sets the moist air flow arrangement as either inside a tube or set of tubes, or perpendicular to a tube bank. You can also specify an empirical, generic configuration. The two-phase fluid always flows inside a tube or set of tubes.

When **Flow geometry** is set to Flow perpendicular to bank of circular tubes, use the **Tube bank grid arrangement** parameter to define the two-phase fluid tube bank alignment as either *Inline* or *Staggered*. The red, downward-pointing arrow indicates the direction of moist air flow. Also indicated in the *Inline* figure are the **Number of tube rows along flow direction** and the **Number of tube segments in each tube row** parameters. Here, *flow direction* refers to the moist air flow, and *tube* refers to the two-phase fluid tubing. The **Length of each tube segment in a tube row** parameter is indicated in the *Staggered* figure.

Number of tube segments
in each tube row

Inline

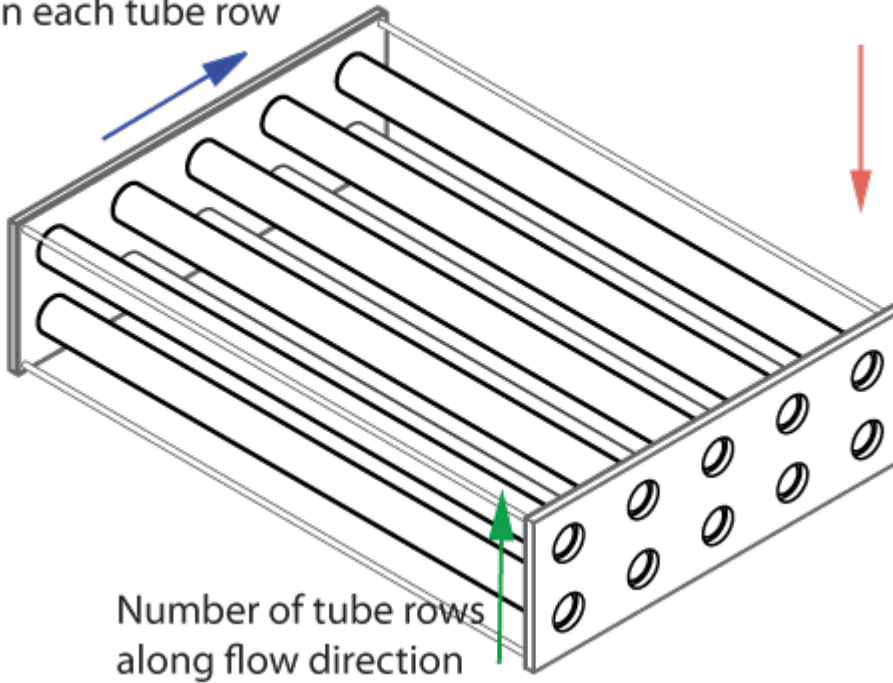

Staggered

Length of each tube
segment in a tube row

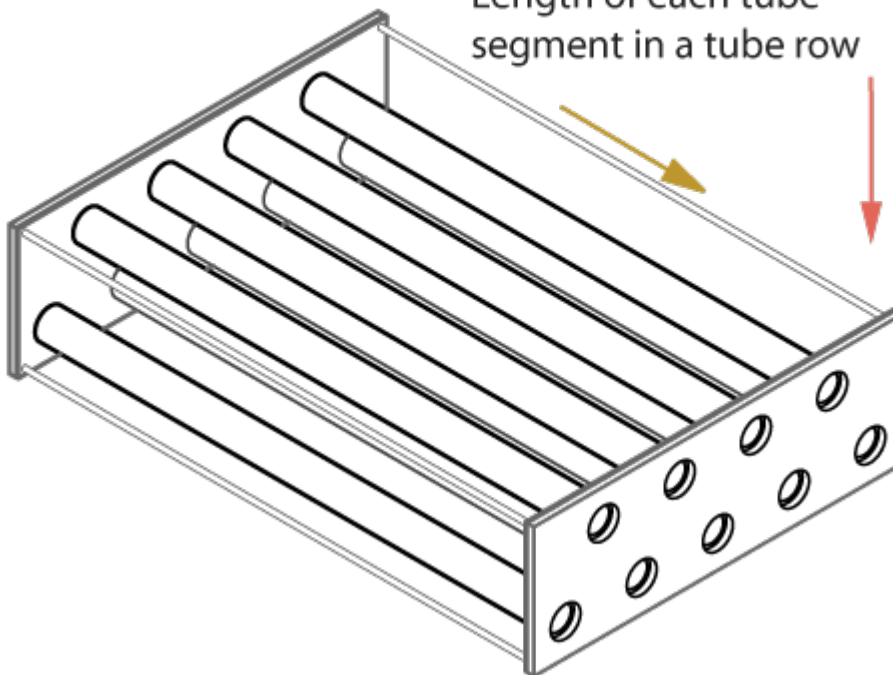

Fins

The heat exchanger configuration is without fins when the **Total fin surface area** parameter is set to 0 m². Fins introduce additional surface area for additional heat transfer. Each fluid side has a separate fin area.

Effectiveness-NTU Heat Transfer

The heat transfer rate is calculated for each fluid phase. In accordance with the three fluid zones that occur on the two-phase fluid side of the heat exchanger, the heat transfer rate is calculated in three sections.

The heat transfer in a zone is calculated as:

$$Q_{zone} = \epsilon C_{\text{Min}}(T_{\text{In},2\text{P}} - T_{\text{In},\text{MA}}),$$

where:

- C_{Min} is the lesser of the heat capacity rates of the two fluids in that zone. The heat capacity rate is the product of the fluid specific heat, c_p , and the fluid mass flow rate. C_{Min} is always positive.
- $T_{\text{In},2\text{P}}$ is the zone inlet temperature of the two-phase fluid.
- $T_{\text{In},\text{MA}}$ is the zone inlet temperature of the moist air.
- ϵ is the heat exchanger effectiveness.

Effectiveness is a function of the heat capacity rate and the number of transfer units, NTU , and also varies based on the heat exchanger flow arrangement, which is discussed in more detail in “Effectiveness by Flow Arrangement” on page 1-472. The NTU is calculated as:

$$NTU = \frac{z}{C_{\text{Min}}R},$$

where:

- z is the individual zone length fraction.
- R is the total thermal resistance between the two flows, due to convection, conduction, and any fouling on the tube walls:

$$R = \frac{1}{U_{2\text{P}}A_{\text{Th},2\text{P}}} + \frac{F_{2\text{P}}}{A_{\text{Th},2\text{P}}} + R_{\text{W}} + \frac{F_{\text{MA}}}{A_{\text{Th},\text{MA}}} + \frac{1}{U_{\text{MA}}A_{\text{Th},\text{MA}}},$$

where:

- U is the convective heat transfer coefficient of the respective fluid. This coefficient is discussed in more detail in “Two-Phase Fluid Correlations” on page 1-474 and “Moist Air Correlations” on page 1-476.
- F is the **Fouling factor** on the two-phase fluid or moist air side, respectively.
- R_{W} is the **Thermal resistance through heat transfer surface**.
- A_{Th} is the heat transfer surface area of the respective side of the exchanger. A_{Th} is the sum of the wall surface area, A_{W} , and the **Total fin surface area**, A_{F} :

$$A_{\text{Th}} = A_{\text{W}} + \eta_{\text{F}}A_{\text{F}},$$

where η_F is the **Fin efficiency**.

The total heat transfer rate between the fluids is the sum of the heat transferred in the three zones by the subcooled liquid (Q_L), liquid-vapor mixture (Q_M), and superheated vapor (Q_V):

$$Q = \sum Q_Z = Q_L + Q_M + Q_V.$$

Effectiveness by Flow Arrangement

The heat exchanger effectiveness varies according to its flow configuration and the mixing in each fluid. Below are the formulations for effectiveness calculated in the liquid and vapor zones for each configuration. The effectiveness is $\varepsilon = 1 - \exp(-NTU)$ for all configurations in the mixture zone.

- When **Flow arrangement** is set to Parallel flow:

$$\varepsilon = \frac{1 - \exp[-NTU(1 + C_R)]}{1 + C_R}$$

- When **Flow arrangement** is set to Counter flow:

$$\varepsilon = \frac{1 - \exp[-NTU(1 - C_R)]}{1 - C_R \exp[-NTU(1 - C_R)]}$$

- When **Flow arrangement** is set to Cross flow and **Cross flow arrangement** is set to Both fluids unmixed:

$$\varepsilon = 1 - \exp\left\{\frac{NTU^{0.22}}{C_R} \left[\exp(-C_R NTU^{0.78}) - 1\right]\right\}$$

- When **Flow arrangement** is set to Cross flow and **Cross flow arrangement** is set to Both fluids mixed:

$$\varepsilon = \left[\frac{1}{1 - \exp(-NTU)} + \frac{C_R}{1 - \exp(-C_R NTU)} - \frac{1}{NTU} \right]^{-1}$$

When one fluid is mixed and the other unmixed, the equation for effectiveness depends on the relative heat capacity rates of the fluids. When **Flow arrangement** is set to Cross flow and **Cross flow arrangement** is set to either Two-Phase Fluid 1 mixed & Moist Air 2 unmixed or Two-Phase Fluid 1 unmixed & Moist Air 2 mixed:

- When the fluid with C_{\max} is mixed and the fluid with C_{\min} is unmixed:

$$\varepsilon = \frac{1}{C_R} (1 - \exp\{-C_R [1 - \exp(-NTU)]\})$$

- When the fluid with C_{\min} is mixed and the fluid with C_{\max} is unmixed:

$$\varepsilon = 1 - \exp\left\{-\frac{1}{C_R} [1 - \exp(-C_R NTU)]\right\}$$

C_R denotes the ratio between the heat capacity rates of the two fluids:

$$C_R = \frac{C_{\min}}{C_{\max}}.$$

Condensation

On the moist air side, a layer of condensation may form on the heat transfer surface. This liquid layer can influence the amount of heat transferred between the moist air and two-phase fluid. The equations for E-NTU heat transfer above are given for *dry* heat transfer. To correct for the influence of condensation, the E-NTU equations are additionally calculated with the wet parameters listed below. Whichever of the two calculated heat flow rates results in a larger amount of moist air side cooling is used in heat calculations for each zone [1]. To use this method, the Lewis number is assumed to be close to 1 [1], which is true for moist air.

E-NTU Quantities Used for Heat Transfer Rate Calculations

	Dry calculation	Wet calculation
Moist air zone inlet temperature	$T_{in,MA}$	$T_{in,wb,MA}$
Heat capacity rate	$\bar{m}_{MA}\bar{c}_{p,MA}$	$\bar{m}_{MA}\bar{c}_{eq,MA}$
Heat transfer coefficient	U_{MA}	$U_{MA}\frac{\bar{c}_{eq,MA}}{\bar{c}_{p,MA}}$

where:

- $T_{in,MA}$ is the moist air zone inlet temperature.
- $T_{in,wb,MA}$ is the moist air wet-bulb temperature associated with $T_{in,MA}$.
- \bar{m}_{MA} is the dry air mass flow rate.
- $\bar{c}_{p,MA}$ is the moist air heat capacity per unit mass of dry air.
- $\bar{c}_{eq,MA}$ is the equivalent heat capacity. The *equivalent heat capacity* is the change in the moist air specific enthalpy (per unit of dry air), \bar{h}_{MA} , with respect to temperature at saturated moist air conditions:

$$\bar{c}_{eq,MA} = \left(\frac{\partial \bar{h}_{MA}}{\partial T_{MA}} \right)_s.$$

The mass flow rate of the condensed water vapor leaving the moist air mass flow depends on the relative humidity between the moist air inlet and the channel wall and the heat exchanger NTUs:

$$\dot{m}_{cond} = -\bar{m}_{MA}(W_{wall,MA} - W_{in,MA})\left(1 - e^{-NTU_{MA}}\right),$$

where:

- $W_{wall,MA}$ is the humidity ratio at the heat transfer surface.
- $W_{in,MA}$ is the humidity ratio at the moist air flow inlet.
- NTU_{MA} is the number of transfer units on the moist air side, calculated as:

$$NTU_{MA} = \frac{U_{MA}\bar{c}_{eq,MA}A_{Th,MA}}{\bar{m}_{MA}\bar{c}_{eq,MA}}.$$

The energy flow associated with water vapor condensation is based on the difference between the vapor specific enthalpy, $h_{water,wall}$, and the specific enthalpy of vaporization, h_{fg} , for water:

$$\phi_{Cond} = \dot{m}_{cond}(h_{water, wall} - h_{fg}).$$

The condensate is assumed to not accumulate on the heat transfer surface, and does not influence geometric parameters such as tube diameter. The condensed water is assumed to be completely removed from the downstream moist air flow.

Two-Phase Fluid Correlations

Heat Transfer Coefficient

The convective heat transfer coefficient varies according to the fluid Nusselt number:

$$U = \frac{Nu k}{D_H},$$

where:

- Nu is the zone mean Nusselt number, which depends on the flow regime.
- k is the fluid phase thermal conductivity.
- D_H is tube hydraulic diameter.

For turbulent flows in the subcooled liquid or superheated vapor zones, the Nusselt number is calculated with the Gnielinski correlation:

$$Nu = \frac{\frac{fD}{8}(Re - 1000)Pr}{1 + 12.7\sqrt{\frac{f}{8}}(Pr^{2/3} - 1)},$$

where:

- Re is the fluid Reynolds number.
- Pr is the fluid Prandtl number.

For turbulent flows in the liquid-vapor mixture zone, the Nusselt number is calculated with the Cavallini-Zecchin correlation:

$$Nu = \frac{a Re_{SL}^b Pr_{SL}^c \left\{ \left[\left(\sqrt{\frac{\rho_{SL}}{\rho_{SV}}} - 1 \right) x_{Out} + 1 \right]^{1+b} - \left[\left(\sqrt{\frac{\rho_{SL}}{\rho_{SV}}} - 1 \right) x_{In} + 1 \right]^{1+b} \right\}}{(1+b) \left(\sqrt{\frac{\rho_{SL}}{\rho_{SV}}} - 1 \right) (x_{Out} - x_{In})}.$$

where:

- Re_{SL} is the Reynolds number of the saturated liquid.
- Pr_{SL} is the Prandtl number of the saturated liquid.
- ρ_{SL} is the density of the saturated liquid.
- ρ_{SV} is the density of the saturated vapor.
- $a = 0.05$, $b = 0.8$, and $c = 0.33$.

For laminar flows, the Nusselt number is set by the **Laminar flow Nusselt number** parameter.

For transitional flows, the Nusselt number is a blend between the laminar and turbulent Nusselt numbers.

Empirical Nusselt Number Formulation

When the **Heat transfer coefficient model** parameter is set to Colburn equation, the Nusselt number for the subcooled liquid and superheated vapor zones is calculated by the empirical the Colburn equation:

$$\text{Nu} = a\text{Re}^b\text{Pr}^c,$$

where a , b , and c are defined in the **Coefficients [a, b, c] for a*Re^b*Pr^c in liquid zone** and **Coefficients [a, b, c] for a*Re^b*Pr^c in vapor zone** parameters.

The Nusselt number for liquid-vapor mixture zones is calculated with the Cavallini-Zecchin equation, with the variables specified in the **Coefficients [a, b, c] for a*Re^b*Pr^c in mixture zone** parameter.

Pressure Loss

The pressure loss due to viscous friction varies depending on flow regime and configuration. The calculation uses the overall density, which is the total two-phase fluid mass divided by the total two-phase fluid volume.

For turbulent flows, when the Reynolds number is above the **Turbulent flow lower Reynolds number limit**, the pressure loss due to friction is calculated in terms of the Darcy friction factor. The pressure differential between port **A1** and the internal node I1 is:

$$p_{A1} - p_{I1} = \frac{f_{D,A}\dot{m}_{A1}|\dot{m}_{A1}|}{2\rho D_H A_{CS}^2} \left(\frac{L + L_{Add}}{2} \right),$$

where:

- \dot{m}_{A1} is the total flow rate through port **A1**.
- $f_{D,A}$ is the Darcy friction factor, according to the Haaland correlation:

$$f_{D,A1} = \left\{ -1.8 \log_{10} \left[\frac{6.9}{\text{Re}_{A1}} + \left(\frac{\epsilon_R}{3.7 D_H} \right)^{1.11} \right] \right\}^{-2},$$

where ϵ_R is the two-phase fluid pipe **Internal surface absolute roughness**. Note that the friction factor is dependent on the Reynolds number, and is calculated at both ports for each liquid.

- L is the **Total length of each tube** on the two-phase fluid side.
- L_{Add} is the two-phase fluid side **Aggregate equivalent length of local resistances**, which is the equivalent length of a tube that introduces the same amount of loss as the sum of the losses due to other local resistances in the tube.
- A_{CS} is the tube cross-sectional area.

The pressure differential between port **B1** and internal node I1 is:

$$p_{B1} - p_{I1} = \frac{f_{D,B}\dot{m}_{B1}|\dot{m}_{B1}|}{2\rho D_H A_{CS}^2} \left(\frac{L + L_{Add}}{2} \right),$$

where \dot{m}_{B1} is the total flow rate through port **B1**.

The Darcy friction factor at port **B1** is:

$$f_{D,B1} = \left\{ -1.8 \log_{10} \left[\frac{6.9}{\text{Re}_{B1}} + \left(\frac{\epsilon_R}{3.7 D_H} \right)^{1.11} \right] \right\}^{-2}.$$

For laminar flows, when the Reynolds number is below the **Laminar flow upper Reynolds number limit**, the pressure loss due to friction is calculated in terms of the **Laminar friction constant for Darcy friction factor**, λ . λ is a user-defined parameter when **Tube cross-section** is set to **Generic**, otherwise, the value is calculated internally. The pressure differential between port **A1** and internal node I1 is:

$$p_{A1} - p_{I1} = \frac{\lambda \mu \dot{m}_{A1}}{2 \rho D_H^2 A_{CS}} \left(\frac{L + L_{\text{Add}}}{2} \right),$$

where μ is the two-phase fluid dynamic viscosity. The pressure differential between port **B1** and internal node I1 is:

$$p_{B1} - p_{I1} = \frac{\lambda \mu \dot{m}_{B1}}{2 \rho D_H^2 A_{CS}} \left(\frac{L + L_{\text{Add}}}{2} \right).$$

For transitional flows, the pressure differential due to viscous friction is a smoothed blend between the values for laminar and turbulent pressure losses.

Empirical Pressure Loss Formulation

When **Pressure loss model** is set to **Pressure loss coefficient**, the pressure losses due to viscous friction are calculated with an empirical pressure loss coefficient, ξ .

The pressure differential between port **A1** and internal node I1 is:

$$p_{A1} - p_{I1} = \frac{1}{2} \xi \frac{\dot{m}_{A1} |\dot{m}_{A1}|}{2 \rho A_{CS}^2}.$$

The pressure differential between port **B1** and internal node I1 is:

$$p_{B1} - p_{I1} = \frac{1}{2} \xi \frac{\dot{m}_{B1} |\dot{m}_{B1}|}{2 \rho A_{CS}^2}.$$

Moist Air Correlations

Heat Transfer Coefficient for Flows Inside One or More Tubes

When the moist air **Flow geometry** is set to **Flow inside one or more tubes**, the Nusselt number is calculated according to the Gnielinski correlation in the same manner as two-phase supercooled liquid or superheated vapor. See "Heat Transfer Coefficient" on page 1-474 for more information.

Heat Transfer Coefficient for Flows Across a Tube Bank

When the moist air **Flow geometry** is set to **Flow perpendicular to bank of circular tubes**, the Nusselt number is calculated based on the Hagen number, Hg , and depends on the **Tube bank grid arrangement** setting:

$$\text{Nu} = \begin{cases} 0.404 L q^{1/3} \left(\frac{\text{Re} + 1}{\text{Re} + 1000} \right)^{0.1}, & \text{Inline} \\ 0.404 L q^{1/3}, & \text{Staggered} \end{cases}$$

where:

$$Lq = \begin{cases} 1.18Pr \left(\frac{4l_T/\pi - D}{l_L} \right) Hg(Re), & \text{Inline} \\ 0.92Pr \left(\frac{4l_T/\pi - D}{l_D} \right) Hg(Re), & \text{Staggered with } l_L \geq D \\ 0.92Pr \left(\frac{4l_T l_L/\pi - D^2}{l_L l_D} \right) Hg(Re), & \text{Staggered with } l_L < D \end{cases}$$

- D is the **Tube outer diameter**.
- l_L is the **Longitudinal tube pitch (along flow direction)**, the distance between the tube centers along the flow direction. *Flow direction* refers to the moist air flow.
- l_T is the **Transverse tube pitch (perpendicular to flow direction)**, shown in the figure below. The transverse pitch is the distance between the centers of the two-phase fluid tubing in one row.
- l_D is the diagonal tube spacing, calculated as $l_D = \sqrt{\left(\frac{l_T}{2}\right)^2 + l_L^2}$.

For more information on calculating the Hagen number, see [6].

The longitudinal and transverse pitch distances are the same for both grid bank arrangement types.

Cross-Section of Two-Phase Fluid Tubing with Pitch Measurements

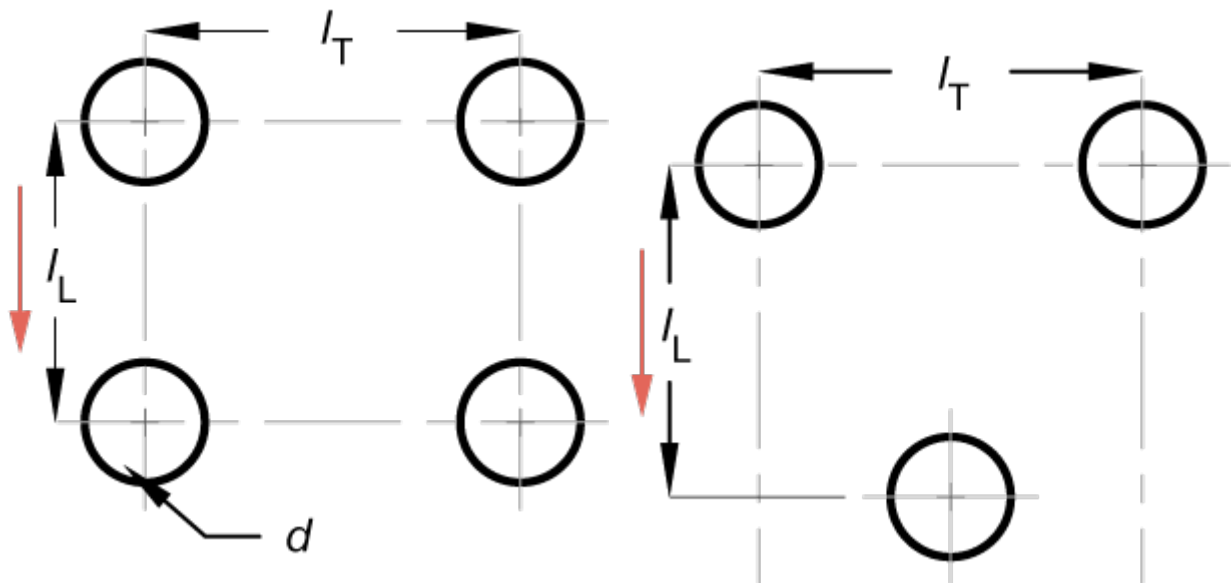

Empirical Nusselt Number Formulation

When the **Heat transfer coefficient model** is set to Colburn equation or when **Flow geometry** is set to Generic, the Nusselt number is calculated by the empirical the Colburn equation:

$$Nu = aRe^b Pr^c,$$

where a , b , and c are the values defined in the **Coefficients [a, b, c] for $a \cdot \text{Re}^b \cdot \text{Pr}^c$** parameter.

Pressure Loss for Flow Inside Tubes

When the moist air **Flow geometry** is set to **Flow inside one or more tubes**, the pressure loss is calculated in the same manner as for two-phase flows, with the respective Darcy friction factor, density, mass flow rates, and pipe lengths of the moist air side. See “Pressure Loss” on page 1-475 for more information.

Pressure Loss for Flow Across Tube Banks

When the moist air **Flow geometry** is set to **Flow perpendicular to bank of circular tubes**, the Hagen number is used to calculate the pressure loss due to viscous friction. The pressure differential between port **A2** and internal node I2 is:

$$p_{A2} - p_{I2} = \frac{1}{2} \frac{\mu^2 N_R}{\rho D^2} \text{Hg}(\text{Re}),$$

where:

- μ_{MA} is the fluid dynamic viscosity.
- N_R is the **Number of tube rows along flow direction**. This is the number of two-phase fluid tube rows along the moist air flow direction.

The pressure differential between port **B2** and internal node I2 is:

$$p_{B2} - p_{I2} = \frac{1}{2} \frac{\mu^2 N_R}{\rho D^2} \text{Hg}(\text{Re}).$$

Empirical Pressure Loss Formulation

When the **Pressure loss model** is set to **Euler number per tube row** or when **Flow geometry** is set to **Generic**, the pressure loss due to viscous friction is calculated with a pressure loss coefficient, in terms of the Euler number, Eu :

$$Eu = \frac{\xi}{N_R},$$

where ξ is the empirical pressure loss coefficient.

The pressure differential between port **A2** and internal node I2 is:

$$p_{A2} - p_{I2} = \frac{1}{2} N_R Eu \frac{\dot{m}_{A2} |\dot{m}_{A2}|}{2 \rho A_{CS}^2}.$$

The pressure differential between port **B2** and internal node I2 is:

$$p_{B2} - p_{I2} = \frac{1}{2} N_R Eu \frac{\dot{m}_{B2} |\dot{m}_{B2}|}{2 \rho A_{CS}^2}.$$

Conservation Equations

Two-Phase Fluid

The total mass accumulation rate in the two-phase fluid is defined as:

$$\frac{dM_{2P}}{dt} = \dot{m}_{A1} + \dot{m}_{B1},$$

where:

- M_{2P} is the total mass of the two-phase fluid.
- \dot{m}_{A1} is the mass flow rate of the fluid at port **A1**.
- \dot{m}_{B1} is the mass flow rate of the fluid at port **B1**.

The flow is positive when flowing into the block through the port.

The energy conservation equation relates the change in specific internal energy to the heat transfer by the fluid:

$$M_{2P} \frac{du_{2P}}{dt} + u_{2P}(\dot{m}_{A1} + \dot{m}_{B1}) = \phi_{A1} + \phi_{B1} - Q,$$

where:

- u_{2P} is the two-phase fluid specific internal energy.
- ϕ_{A1} is the energy flow rate at port **A1**.
- ϕ_{B1} is the energy flow rate at port **B1**.
- Q is heat transfer rate, which is positive when leaving the two-phase fluid volume.

Moist Air

There are three equations for mass conservation on the moist air side: one for the moist air mixture, one for condensed water vapor, and one for the trace gas.

Note If **Trace gas model** is set to **None** in the Moist Air Properties (MA) block, the trace gas is not modeled in blocks in the moist air network. In the Condenser Evaporator (2P-MA) block, this means that the conservation equation for trace gas is set to 0.

The moist air mixture mass accumulation rate accounts for the changes of the entire moist air mass flow through the exchanger ports and the condensation mass flow rate:

$$\frac{dM_{MA}}{dt} = \dot{m}_{A2} + \dot{m}_{B2} - \dot{m}_{\text{Cond}}.$$

The mass conservation equation for water vapor accounts for the water vapor transit through the moist air side and condensation formation:

$$\frac{dx_w}{dt} M_{MA} + x_w(\dot{m}_{A2} + \dot{m}_{B2} - \dot{m}_{\text{Cond}}) = \dot{m}_{w,A2} + \dot{m}_{w,B2} - \dot{m}_{\text{Cond}},$$

where:

- x_w is the mass fraction of the vapor. $\frac{dx_w}{dt}$ is the rate of change of this fraction.
- $\dot{m}_{w,A2}$ is the water vapor mass flow rate at port **A2**.
- $\dot{m}_{w,B2}$ is the water vapor mass flow rate at port **B2**.

- \dot{m}_{Cond} is the rate of condensation.

The trace gas mass balance is:

$$\frac{dx_g}{dt} M_{MA} + x_g(\dot{m}_{A2} + \dot{m}_{B2} - \dot{m}_{Cond}) = \dot{m}_{g,A2} + \dot{m}_{g,B2},$$

where:

- x_g is the mass fraction of the trace gas. $\frac{dx_g}{dt}$ is the rate of change of this fraction.
- $\dot{m}_{g,A2}$ is the trace gas mass flow rate at port **A2**.
- $\dot{m}_{g,B2}$ is the trace gas mass flow rate at port **B2**.

Energy conservation on the moist air side accounts for the change in specific internal energy due to heat transfer and water vapor condensing out of the moist air mass:

$$M_{MA} \frac{du_{MA}}{dt} + u_{MA}(\dot{m}_{A2} + \dot{m}_{B2} - \dot{m}_{Cond}) = \phi_{A2} + \phi_{B2} + Q - \phi_{Cond},$$

where:

- ϕ_{A2} is the energy flow rate at port **A2**.
- ϕ_{B2} is the energy flow rate at port **B2**.
- ϕ_{Cond} is the energy flow rate due to condensation.

The heat transferred to or from the moist air, Q , is equal to the heat transferred from or to the two-phase fluid.

Ports

Conserving

A1 — Two-phase fluid port

two-phase fluid

Inlet or outlet port associated with the two-phase fluid.

B1 — Two-phase fluid port

two-phase fluid

Inlet or outlet port associated with the two-phase fluid.

A2 — Moist air port

moist air

Inlet or outlet port associated with the moist air.

B2 — Moist air port

moist air

Inlet or outlet port associated with the moist air.

Output

Z — Two-phase fluid zone length fractions

physical signal

Three-element vector of the zone length fractions in the two-phase fluid channel, returned as a physical signal. The vector takes the form [L, M, V], where L is the sub-cooled liquid, M is the liquid-vapor mixture, and V is the superheated vapor.

W — Moist air condensation rate

physical signal

Water condensation rate in the moist air flow, returned as a physical signal. The condensate does not accumulate on the heat transfer surface.

Parameters

Configuration

Flow arrangement — Flow path alignment

Cross flow (default) | Parallel flow | Counter flow

Flow path alignment between the heat exchanger sides. The available flow arrangements are:

- Parallel flow. The flows run in the same direction.
- Counter flow. The flows run parallel to each other, in the opposite directions.
- Cross flow. The flows run perpendicular to each other.

Cross flow arrangement — Thermal mixing condition

Two-Phase Fluid 1 unmixed & Moist Air 2 mixed (default) | Both fluids unmixed |
Two-phase fluid 1 mixed & Moist Air 2 unmixed | Both fluids mixed

Select whether each of the fluids can mix in its channel. Mixed flow means that the fluid is free to move in the transverse direction as it travels along the flow path. Unmixed flow means that the fluid is restricted to travel only along the flow path. For example, a side with fins is considered an unmixed flow.

Dependencies

To enable this parameter, set **Flow arrangement** to Cross flow.

Thermal resistance through heat transfer surface — Wall thermal resistance

0 K/kW (default) | positive scalar

Thermal resistance of the wall that separates the two sides of the heat exchanger. The wall thermal resistance, wall fouling, and fluid convective heat transfer coefficient influence the amount of heat transferred between the flows.

Cross-sectional area at port A1 — Flow area at port A1

0.01 m² (default) | positive scalar

Flow area at the two-phase fluid port **A1**.

Cross-sectional area at port B1 — Flow area at port B1

0.01 m² (default) | positive scalar

Flow area at the two-phase fluid port **B1**.

Cross-sectional area at port A2 — Flow area at port A2

0.01 m² (default) | positive scalar

Flow area at the moist air side port **A2**.

Cross-sectional area at port B2 — Area normal to flow at port B2

0.01 m² (default) | positive scalar

Flow area at the moist air side port **B2**.

Two-Phase Fluid 1

Number of tubes — Number of two-phase fluid tubes

25 (default) | positive scalar

Number of two-phase fluid tubes.

Total length of each tube — Total length of each two-phase fluid tube

1 m (default) | positive scalar

Total length of each two-phase fluid tube.

Tube cross section — Cross-sectional shape of a tube

Circular (default) | Rectangular | Annular | Generic

Cross-sectional shape of a tube. Use `Generic` to specify an arbitrary cross-sectional geometry.

This parameter specifies the cross-section of one tube.

Tube inner diameter — Internal diameter of a single tube

0.05 m (default) | positive scalar

Internal diameter of the cross-section of one tube. The cross-section and diameter are uniform along the tube. The size of the diameter influences the pressure loss and heat transfer calculations.

Dependencies

To enable this parameter, set **Tube cross-section** to `Circular`.

Tube width — Internal width of a single tube

0.05 m (default) | positive scalar

Internal width of the cross-section of one tube. The cross-section and width are uniform along the tube. The width and height influence the pressure loss and heat transfer calculations.

Dependencies

To enable this parameter, set **Tube cross-section** to `Rectangular`.

Tube height — Internal height of a single tube

0.05 m (default) | positive scalar

Internal height of one tube. The cross-section and height are uniform along the tube. The width and height influence the pressure loss and heat transfer calculations.

Dependencies

To enable this parameter, set **Tube cross-section** to Rectangular.

Annulus inner diameter (heat transfer surface) – Smaller diameter of annular cross-section

0.05 m (default) | positive scalar

Smaller diameter of the annular cross-section of one tube. The cross-section and inner diameter are uniform along the tube. The inner diameter influences the pressure loss and heat transfer calculations. Heat transfer occurs through the inner surface of the annulus.

Dependencies

To enable this parameter, set **Tube cross-section** to Annular.

Annulus outer diameter – Larger diameter of annular cross-section

0.1 m (default) | positive scalar

Larger diameter of the annular cross-section of one tube. The cross-section and outer diameter are uniform along the tube. The outer diameter influences the pressure loss and heat transfer calculations.

Dependencies

To enable this parameter, set **Tube cross-section** to Annular.

Cross-sectional area per tube – Internal area normal to flow in a single tube

0.002 m² (default) | positive scalar

Internal flow area of each tube.

Dependencies

To enable this parameter, set **Tube cross-section** to Generic.

Wetted perimeter of tube cross-section for pressure loss – Perimeter of tube cross-section that fluid touches

0.15 m (default) | positive scalar

Perimeter of the tube cross-section that the fluid touches. The cross-section and perimeter are uniform along the tube. This value is applied in pressure loss calculations.

Dependencies

To enable this parameter, set **Tube cross-section** to Generic.

Perimeter of tube cross-section for heat transfer – Perimeter of a single tube for heat transfer calculations

0.15 m (default) | positive scalar

Tube perimeter for heat transfer calculations. This is often the same as the tube perimeter, but in cases such as the annular cross-section, this may be only the inner or outer diameter, depending on the heat-transferring surface. The cross-section and tube perimeter are uniform along the tube.

Dependencies

To enable this parameter, set **Tube cross-section** to Generic.

Pressure loss model – Method of pressure loss calculation due to viscous friction

Correlation for flow inside tubes (default) | Pressure loss coefficient

Method of pressure loss calculation due to viscous friction. The settings are:

- **Pressure loss coefficient.** Use this setting to calculate the pressure loss based on an empirical loss coefficient.
- **Correlation for flow inside tubes.** Use this setting to calculate the pressure loss based on the pipe flow correlation.

Pressure loss coefficient, $\Delta p / (0.5 \cdot \rho \cdot v^2)$ – Empirical loss coefficient for all pressure losses in channel

10 (default)

Empirical loss coefficient for all pressure losses in the channel. This value accounts for wall friction and minor losses due to bends, elbows, and other geometry changes in the channel.

The loss coefficient can be calculated from a nominal operating condition or be tuned to fit experimental data. The loss coefficient is defined as:

$$\xi = \frac{\Delta p}{\frac{1}{2} \rho v^2},$$

where Δp is the pressure drop, ρ is the two-phase fluid density, and v is the flow velocity.

Dependencies

To enable this parameter, set **Pressure loss model** to Pressure loss coefficient.

Aggregate equivalent length of local resistances – Combined length of all local resistances in the tubes

0.1 m (default) | positive scalar

Combined length of all local resistances in the tubes. This parameter describes the length of tubing that results in the same pressure losses as the sum of all minor losses in the tube due to bends, tees, or unions. A longer equivalent length results in larger pressure losses.

Dependencies

To enable this parameter, set **Pressure loss model** to Correlation for flow inside tubes.

Internal surface absolute roughness – Mean surface roughness height

15e-6 m (default) | positive scalar

Mean height of tube surface defects. A rougher wall results in larger pressure losses in the turbulent regime for pressure loss calculated with the Haaland correlation.

Dependencies

To enable this parameter, set either:

- **Pressure loss model**
- **Heat transfer model**

to Correlation for flow inside tubes.

Laminar flow upper Reynolds number limit – Largest Reynolds number that indicates laminar flow

2000 (default) | positive scalar

Largest Reynolds number that indicates laminar flow. Between this value and the **Turbulent flow lower Reynolds number**, the flow regime is transitional.

Turbulent flow lower Reynolds number limit – Smallest Reynolds number that indicates turbulent flow

4000 (default) | positive scalar

Smallest Reynolds number that indicates turbulent flow. Between this value and the **Laminar flow upper Reynolds number limit**, the flow regime is transitional.

Laminar friction constant for Darcy friction factor – Coefficient of pressure loss due to viscous friction in laminar flows

64 (default) | positive scalar

Coefficient in pressure loss equations for viscous friction in laminar flows. This parameter may also be known as the *shape factor*. The default value corresponds to a circular tube cross-section.

Dependencies

To enable this parameter, set **Tube cross section** to Generic and **Pressure loss model** to Correlation for flow inside tubes.

Heat transfer coefficient model – Method of calculating heat transfer coefficient between fluid and wall

Correlation for flow inside tubes (default) | Colburn equation

Method of calculating the heat transfer coefficient between the fluid and the wall. The available settings are:

- **Colburn equation.** Use this setting to calculate the heat transfer coefficient with user-defined variables a , b , and c . In the liquid and vapor zones, the heat transfer coefficient is based on the Colburn equation. In the liquid-vapor mixture zone, the heat transfer coefficient is based on the Cavallini-Zecchin equation.
- **Correlation for flow inside tubes.** Use this setting to calculate the heat transfer coefficient for pipe flows. In the liquid and vapor zones, the heat transfer coefficient is calculated with the Gnielinski correlation. In the liquid-vapor mixture zone, the heat transfer coefficient is calculated with the Cavallini-Zecchin equation.

Coefficients [a, b, c] for aRe^bPr^c in liquid zone – Colburn equation coefficients in liquid zone

[.023, .8, .33] (default) | three-element vector of positive scalars

Three-element vector containing the empirical coefficients of the Colburn equation. Each fluid zone has a distinct Nusselt number, which is calculated by the Colburn equation per zone. The general form of the Colburn equation is:

$$Nu = aRe^bPr^c.$$

Dependencies

To enable this parameter, set **Heat transfer coefficient model** to Colburn equation.

Coefficients [a, b, c] for aRe^bPr^c in mixture zone – Cavallini-Zecchin equation coefficients in mixture zone

[.05, .8, .33] (default) | three-element vector of positive scalars

Three-element vector containing the empirical coefficients of the Cavallini-Zecchin equation. Each fluid zone has a distinct Nusselt number, which is calculated in the mixture zone by the Cavallini-Zecchin equation:

$$Nu = \frac{aRe_{SL}^b Pr_{SL}^c \left\{ \left[\left(\sqrt{\frac{\rho_{SL}}{\rho_{SV}}} - 1 \right) x_{Out} + 1 \right]^{1+b} - \left[\left(\sqrt{\frac{\rho_{SL}}{\rho_{SV}}} - 1 \right) x_{In} + 1 \right]^{1+b} \right\}}{(1+b) \left(\sqrt{\frac{\rho_{SL}}{\rho_{SV}}} - 1 \right) (x_{Out} - x_{In})}$$

Dependencies

To enable this parameter, set **Heat transfer coefficient model** to Colburn equation.

Coefficients [a, b, c] for aRe^bPr^c in vapor zone – Colburn equation coefficients in vapor zone

[.023, .8, .33] (default) | three-element vector of positive scalars

Three-element vector containing the empirical coefficients of the Colburn equation. Each fluid zone has a distinct Nusselt number, which is calculated by the Colburn equation per zone. The general form of the Colburn equation is:

$$Nu = aRe^b Pr^c.$$

Dependencies

To enable this parameter, set **Heat transfer coefficient model** to Colburn equation.

Laminar flow Nusselt number – Ratio of convective to conductive heat transfer in the laminar flow regime

3.66 (default) | positive scalar

Ratio of convective to conductive heat transfer in the laminar flow regime. The fluid Nusselt number influences the heat transfer rate and depends on the tube cross-section.

Dependencies

To enable this parameter, set **Heat transfer coefficient model** to Correlation for flow inside tubes.

Fouling factor – Additional thermal resistance due to fouling deposits

0.1 m²*K/kW (default) | positive scalar

Additional thermal resistance due to fouling layers on the surfaces of the wall. In real systems, fouling deposits grow over time. However, the growth is slow enough to be assumed constant during the simulation.

Total fin surface area – Total heat transfer surface area of fins

0 m² (default) | positive scalar

Total heat transfer surface area of both sides of all fins. For example, if the fin is rectangular, the surface area is double the area of the rectangle.

The total heat transfer surface area is the sum of the channel surface area and the effective fin surface area, which is the product of the **Fin efficiency** and the **Total fin surface area**.

Fin efficiency — Ratio of fin actual to ideal heat transfer rates

0.5 (default) | positive scalar in the range [0,1]

Ratio of actual heat transfer to ideal heat transfer through the fins.

Initial fluid energy specification — Initial state of the two-phase fluid

Temperature (default) | Vapor quality | Vapor void fraction | Specific enthalpy | Specific internal energy

Quantity used to describe the initial state of the fluid: temperature, vapor quality, vapor void fraction, specific enthalpy, or specific internal energy.

Initial two-phase fluid pressure — Fluid pressure at start of simulation

0.101325 MPa (default) | positive scalar

Fluid pressure at the start of the simulation.

Initial two-phase fluid temperature — Temperature at start of simulation

293.15 K (default) | positive scalar | two-element vector

Temperature in the two-phase fluid channel at the start of simulation. This parameter can be a scalar or a two-element vector. A scalar value represents the mean initial temperature in the channel. A vector value represents the initial temperature at the inlet and outlet in the form [inlet, outlet]. The block calculates a linear gradient between the two ports. The inlet and the outlet ports are identified according to the initial flow direction.

Dependencies

To enable this parameter, set **Initial fluid energy specification** to Temperature.

Initial two-phase fluid vapor quality — Vapor mass fraction at start of simulation

0.5 (default) | positive scalar in the range [0,1] | two-element vector

Vapor mass fraction in the two-phase fluid channel at the start of simulation. This parameter can be a scalar or a two-element vector. A scalar value represents the mean initial vapor quality in the channel. A vector value represents the initial vapor quality at the inlet and outlet in the form [inlet, outlet]. The block calculates a linear gradient between the two ports. The inlet and the outlet ports are identified according to the initial flow direction.

Dependencies

To enable this parameter, set **Initial fluid energy specification** to Vapor quality.

Initial two-phase fluid vapor void fraction — Vapor volume fraction at start of simulation

0.5 (default) | positive scalar in the range [0,1] | two-element vector

Vapor volume fraction in the two-phase fluid channel at the start of simulation. This parameter can be a scalar or a two-element vector. A scalar value represents the mean initial void fraction in the channel. A vector value represents the initial void fraction at the inlet and outlet in the form [inlet, outlet]. The block calculates a linear gradient between the two ports. The inlet and the outlet ports are identified according to the initial flow direction.

Dependencies

To enable this parameter, set **Initial fluid energy specification** to Vapor void fraction.

Initial two-phase fluid specific enthalpy — Enthalpy per unit mass at start of simulation

1500 kJ/kg (default) | positive scalar | two-element vector

Enthalpy per unit mass in the two-phase fluid channel at the start of simulation. This parameter can be a scalar or a two-element vector. A scalar value represents the mean initial specific enthalpy in the channel. A vector value represents the initial specific enthalpy at the inlet and outlet in the form [inlet, outlet]. The block calculates a linear gradient between the two ports. The inlet and the outlet ports are identified according to the initial flow direction.

Dependencies

To enable this parameter, set **Initial fluid energy specification** to Specific enthalpy.

Initial two-phase fluid specific internal energy — Internal energy per unit mass at start of simulation

1500 kJ/kg (default) | positive scalar | two-element vector

Internal energy per unit mass in the two-phase fluid channel at the start of simulation. This parameter can be a scalar or a two-element vector. A scalar value represents the mean initial specific internal energy in the channel. A vector value represents the initial specific internal energy at the inlet and outlet in the form [inlet, outlet]. The block calculates a linear gradient between the two ports. The inlet and the outlet ports are identified according to the initial flow direction.

Dependencies

To enable this parameter, set **Initial fluid energy specification** to Specific internal energy.

Moist Air 2**Flow geometry — Moist air flow configuration**

Flow perpendicular to bank of circular tubes (default) | Flow inside one or more tubes | Generic

Moist air flow path. The flow can run externally over a set of tubes or internal to a tube or set of tubes. You can also specify a generic parameterization based on empirical values.

Number of tubes — Number of moist air tubes

25 (default) | positive scalar

Number of moist air tubes. More tubes result in higher pressure losses due to viscous friction, but a larger amount of surface area for heat transfer.

Dependencies

To enable this parameter, set **Flow geometry** to Flow inside one or more tubes.

Total length of each tube — Total length of each moist air tube

1 m (default) | positive scalar

Total length of each moist air tube.

Dependencies

To enable this parameter, set **Flow geometry** to Flow inside one or more tubes.

Tube cross section — Cross-sectional shape of a tube

Circular (default) | Rectangular | Annular | Generic

Cross-sectional shape of one tube. Set to Generic to specify an arbitrary cross-sectional geometry.

Dependencies

To enable this parameter, set **Flow geometry** to Flow inside one or more tubes.

Tube inner diameter — Internal diameter of a single tube

0.05 m (default) | positive scalar

Internal diameter of the cross-section of one tube. The cross-section and diameter are uniform along the tube. The size of the diameter influences the pressure loss and heat transfer calculations.

Dependencies

To enable this parameter, set **Flow geometry** to Flow inside one or more tubes and **Tube cross-section** to Circular.

Tube width — Internal width of a single tube

0.05 m (default) | positive scalar

Internal width of the cross-section of one tube. The cross-section and width are uniform along the tube. The width and height influence the pressure loss and heat transfer calculations.

Dependencies

To enable this parameter, set **Flow geometry** to Flow inside one or more tubes and **Tube cross-section** to Rectangular.

Tube height — Internal height of a single tube

0.05 m (default) | positive scalar

Internal height of one tube cross-section. The cross-section and height are uniform along the tube. The width and height influence the pressure loss and heat transfer calculations.

Dependencies

To enable this parameter, set **Flow geometry** parameterization of Flow inside one or more tubes and **Tube cross-section** to Rectangular.

Annulus inner diameter (heat transfer surface) — Smaller diameter of annular cross-section

0.05 m (default) | positive scalar

Smaller diameter of the annular cross-section of one tube. The cross-section and inner diameter are uniform along the tube. The inner diameter influences the pressure loss and heat transfer calculations. Heat transfer occurs through the inner surface of the annulus.

Dependencies

To enable this parameter, set **Flow geometry** parameterization of Flow inside one or more tubes and **Tube cross-section** to Annular.

Annulus outer diameter — Larger diameter of annular cross-section

0.1 m (default) | positive scalar

Larger diameter of the annular cross-section of one tube. The cross-section and outer diameter are uniform along the tube. The outer diameter influences the pressure loss and heat transfer calculations.

Dependencies

To enable this parameter, set **Flow geometry** to Flow inside one or more tubes and **Tube cross-section** to Annular.

Cross-sectional area per tube — Internal flow area in each tube

0.002 m² (default) | positive scalar

Internal flow area of each tube.

Dependencies

To enable this parameter, set **Flow geometry** to Flow inside one or more tubes and **Tube cross-section** to Generic.

Wetted perimeter of tube cross-section for pressure loss — Perimeter of tube cross-section that fluid touches

0.15 m (default) | positive scalar

Perimeter of the tube cross-section that the fluid touches. The cross-section and perimeter are uniform along the tube. This value is applied in pressure loss calculations.

Dependencies

To enable this parameter, set **Flow geometry** to Flow inside one or more tubes and **Tube cross-section** to Generic.

Perimeter of tube cross-section for heat transfer — Perimeter of a single tube for heat transfer calculations

0.15 m (default) | positive scalar

Tube perimeter for heat transfer calculations. This is often the same as the tube perimeter, but in cases such as the annular cross-section, this may be only the inner or outer diameter, depending on the heat-transferring surface. The cross-section and tube perimeter are uniform along the tube.

Dependencies

To enable this parameter, set **Flow geometry** to Flow inside one or more tubes and **Tube cross-section** to Generic.

Pressure loss model — Method of pressure loss calculation due to viscous friction

Correlation for flow inside tubes (default) | Euler number per tube row | Pressure loss coefficient | Correlation for flow over tube bank

Method of pressure loss calculation due to viscous friction. Different models are available for different flow configurations. The settings are:

- Correlation for flow inside tubes. Use this setting to calculate the pressure loss with the Haaland correlation.

- **Pressure loss coefficient.** Use this setting to calculate the pressure loss based on an empirical loss coefficient.
- **Euler number per tube row.** Use this setting to calculate the pressure loss based on an empirical Euler number.
- **Correlation for flow over tube bank.** Use this setting to calculate the pressure loss based on the Hagen number.

The pressure loss models available depend on the **Flow geometry** setting.

Dependencies

When **Flow geometry** is set to Flow inside one or more tubes, **Pressure loss model** can be set to either:

- Pressure loss coefficient.
- Correlation for flow inside tubes.

When **Flow geometry** is set to Flow perpendicular to bank of circular tubes, **Pressure loss model** can be set to either:

- Correlation for flow over tube bank.
- Euler number per tube row.

When **Flow geometry** is set to Generic, the **Pressure loss model** parameter is disabled. Pressure loss is calculated empirically with the **Pressure loss coefficient, $\Delta p / (0.5 \cdot \rho \cdot v^2)$** parameter.

Pressure loss coefficient, $\Delta p / (0.5 \cdot \rho \cdot v^2)$ – Empirical loss coefficient for all pressure losses in the channel

10 (default) | positive scalar

Empirical loss coefficient for all pressure losses in the channel. This value accounts for wall friction and minor losses due to bends, elbows, and other geometry changes in the channel.

The loss coefficient can be calculated from a nominal operating condition or be tuned to fit experimental data. The pressure loss coefficient is defined as:

$$\xi = \frac{\Delta p}{\frac{1}{2} \rho v^2},$$

where Δp is the pressure drop, ρ is the two-phase fluid density, and v is the flow velocity.

Dependencies

To enable this parameter, set either:

- **Flow geometry** to Generic.
- **Pressure loss model** to Pressure loss coefficient.

Aggregate equivalent length of local resistances – Combined length of all local resistances in the tubes

0.1 m (default) | positive scalar

Combined length of all local resistances in the tubes. This is the length of tubing that results in the same pressure losses as the sum of all minor losses in the tube due to such things as bends, tees, or unions. A longer equivalent length results in larger pressure losses.

Dependencies

To enable this parameter, set **Pressure loss model** to Correlations for flow inside tubes.

Internal surface absolute roughness — Mean surface roughness height

15e-6 m (default) | positive scalar

Mean height of tube surface defects. A rougher wall results in larger pressure losses in the turbulent regime for pressure loss calculated with the Haaland correlation.

Dependencies

To enable this parameter, set either:

- **Pressure loss model**
- **Heat transfer coefficient model**

to Correlation for flow inside tubes.

Laminar flow upper Reynolds number limit — Largest Reynolds number that indicates laminar flow

2000 (default) | positive scalar

Largest Reynolds number that indicates laminar flow. Between this value and the **Turbulent flow lower Reynolds number limit**, the flow regime is transitional.

Dependencies

To enable this parameter, set **Flow geometry** to Flow inside one or more tubes and **Pressure loss model** to Correlation for flow inside tubes.

Turbulent flow lower Reynolds number limit — Smallest Reynolds number that indicates turbulent flow

4000 (default) | positive scalar

Smallest Reynolds number that indicates turbulent flow. Between this value and the **Laminar flow upper Reynolds number limit**, the flow regime is transitional between the laminar and turbulent regimes.

Dependencies

To enable this parameter, set **Flow geometry** to Flow inside one or more tubes and **Pressure loss model** to Correlation for flow inside tubes.

Laminar friction constant for Darcy friction factor — Coefficient of pressure loss due to viscous friction in laminar flows

64 (default) | positive scalar

Coefficient in pressure loss equations for viscous friction in laminar flows. This parameter is also known as the *shape factor*. The default value corresponds to a circular tube cross-section.

Dependencies

To enable this parameter, set **Flow geometry** to Correlation for flow inside tubes, **Tube cross section** to Generic, and **Pressure loss model** to Correlation for flow inside tubes.

Heat transfer coefficient model — Method of calculating heat transfer coefficient between fluid and wall

Correlation for flow over tube bank (default) | Colburn equation | Correlation for flow inside tubes

Method of calculating the heat transfer coefficient between the fluid and the wall. The available settings are:

- Colburn equation. Use this setting to calculate the heat transfer coefficient with user-defined variables a , b , and c of the Colburn equation.
- Correlation for flow over tube bank. Use this setting to calculate the heat transfer coefficient based on the tube bank correlation using the Hagen number.
- Correlation for flow inside tubes. Use this setting to calculate the heat transfer coefficient for pipe flows with the Gnielinski correlation.

Dependencies

To enable this parameter, set **Flow geometry** to either:

- Flow perpendicular to bank of circular tubes.
- Flow inside one or more tubes.

Coefficients [a, b, c] for $a \cdot Re^b \cdot Pr^c$ — Colburn equation coefficients

[0.023, 0.8, 0.33] (default) | three-element vector

Three-element vector containing the empirical coefficients of the Colburn equation. The Colburn equation is a formulation for calculating the Nusselt Number. The general form of the Colburn equation is:

$$Nu = aRe^bPr^c.$$

When the **Heat transfer coefficient model** is set to **Colburn equation** and **Flow geometry** is set to Flow inside one or more tubes, or **Flow geometry** is set to Generic, the default Colburn equation is:

$$Nu = 0.023Re^{0.8}Pr^{1/3}.$$

When the **Heat transfer coefficient model** is set to **Colburn equation** and **Flow geometry** is set to Flow perpendicular to bank of circular tubes, the default Colburn equation is:

$$Nu = 0.27Re^{0.63}Pr^{0.36}.$$

Dependencies

To enable this parameter, set:

1 Flow geometry to either:

- Flow inside one or more tubes

- Flow perpendicular to bank of circular tubes
and **Heat transfer coefficient model** to Colburn equation.

2 Flow geometry to Generic.

Laminar flow Nusselt number – Ratio of convective to conductive heat transfer in laminar flow regime

3.66 (default) | positive scalar

Ratio of convective to conductive heat transfer in the laminar flow regime. The fluid Nusselt number influences the heat transfer rate and depends on the tube cross-section.

Dependencies

To enable this parameter, set **Flow geometry** to Flow inside one or more tubes, **Tube cross-section** to Generic, and **Heat transfer parameterization** to Correlation for flow inside tubes.

Tube bank grid arrangement – Geometrical placement of tube rows in the bank

Inline (default) | Staggered

Alignment of tubes in a tube bank. Rows are either in line with their neighbors, or staggered.

- **Inline:** All tube rows are located directly behind each other.
- **Staggered:** Tubes of the one tube row are located at the gap between tubes of the previous tube row.

Tube alignment influences the Nusselt number and the heat transfer rate.

Dependencies

To enable this parameter, set **Flow geometry** to Flow perpendicular to bank of circular tubes.

Number of tube rows along flow direction – Number of tube rows in tube bank

5 (default) | positive scalar

Number of two-phase fluid tube rows in a tube bank. The rows are aligned with the direction of moist air flow.

Dependencies

To enable this parameter, set **Flow geometry** to Flow perpendicular to bank of circular tubes.

Number of tube segments in each tube row – Number of two-phase fluid tubes in each row of the tube bank

5 (default) | positive scalar

Number of two-phase fluid tubes in each row of a tube bank. This measurement is perpendicular to the moist air flow.

Dependencies

To enable this parameter, set **Flow geometry** to Flow perpendicular to bank of circular tubes.

Length of each tube segment in a tube row — Length of each two-phase fluid tube

1 m (default) | positive scalar

Length of each two-phase fluid tube that spans a tube row. All tubes in a tube bank are the same length.

Dependencies

To enable this parameter, set **Flow geometry** to Flow perpendicular to bank of circular tubes.

Tube outer diameter — Outer diameter of a single two-phase fluid tube

0.05 m (default) | positive scalar

Outer diameter of a two-phase fluid tube. The cross-section is uniform along a tube and so the diameter is constant throughout. This value influences the losses in the flow across a tube bank due to viscous friction.

Dependencies

To enable this parameter, set **Flow geometry** to Flow perpendicular to bank of circular tubes.

Longitudinal tube pitch (along flow direction) — Center-to-center distance between two-phase fluid tube rows

0.15 m (default) | positive scalar

Distance between tube centers of the two-phase fluid tubes, aligned with the direction of flow of the moist air.

Dependencies

To enable this parameter, set **Flow geometry** to Flow perpendicular to bank of circular tubes.

Transverse tube pitch (perpendicular to flow direction) — Center-to-center distance between two-phase fluid tubes in a row

0.15 m (default) | positive scalar

Distance between the tube centers in a row of two-phase fluid tubes. This measurement is perpendicular to the moist air flow direction. See “Heat Transfer Coefficient for Flows Across a Tube Bank” on page 1-476 for more information.

Dependencies

To enable this parameter, set **Flow geometry** to Flow perpendicular to bank of circular tubes.

Euler number per tube row, $\Delta p / (N \cdot 0.5 \cdot \rho \cdot v^2)$ — Euler number for each row of the tube bank

10 (default) | positive scalar

Empirical coefficient for pressure drop across one tube row. The Euler number is the ratio between pressure drop and fluid momentum:

$$Eu = \frac{\Delta p}{N \frac{1}{2} \rho v^2}$$

where N is the **Number of tube rows along flow direction**, Δp is the pressure drop, ρ is the moist air mixture density, and v is the flow velocity.

Each tube row is located in a plane perpendicular to the moist air flow.

Dependencies

To enable this parameter, set **Flow geometry** to Flow perpendicular to bank of circular tubes and **Pressure loss model** to Euler number per tube row.

Minimum free-flow area — Smallest total flow area between inlet and outlet

0.01 m² (default) | positive scalar

Smallest total flow area between inlet and outlet. If the channel is a collection of ducts, tubes, slots, or grooves, the minimum free-flow area is the sum of the smallest areas.

Dependencies

To enable this parameter, set **Flow geometry** to Generic.

Heat transfer surface area without fins — Total area of the heat transfer surface excluding fins

2 m² (default) | positive scalar

Total area of the heat transfer surface, excluding fins.

Dependencies

To enable this parameter, set **Flow geometry** to Generic.

Moist air volume inside heat exchanger — Total volume of moist air in the heat exchanger

0.05 m³ (default) | positive scalar

Total volume of moist air in the heat exchanger.

Dependencies

To enable this parameter, set **Flow geometry** to Generic.

Fouling factor — Additional thermal resistance due to fouling deposits

0.1 m²*K/kW (default) | positive scalar

Additional thermal resistance due to fouling layers on the surfaces of the wall. In real systems, fouling deposits grow over time. However, the growth is slow enough to be assumed constant during the simulation.

Total fin surface area — Total heat transfer surface area of all fins

0 m² (default) | positive scalar

Total heat transfer surface area of both sides of all fins. For example, if the fin is rectangular, the surface area is double the area of the rectangle.

The total heat transfer surface area is the sum of the channel surface area and the effective fin surface area, which is the product of the **Fin efficiency** and the **Total fin surface area**.

Fin efficiency — Ratio of fin actual to idea heat transfer rates

0.5 (default) | positive scalar in the range [0,1]

Ratio of actual heat transfer to ideal heat transfer through the fins.

Initial moist air pressure — Moist air pressure at start of simulation

0.101325 MPa (default) | positive scalar

Moist air pressure at the start of the simulation.

Initial moist air temperature — Temperature at the start of simulation

293.15 K (default) | positive scalar | two-element vector

Temperature in the moist air fluid channel at the start of the simulation. This parameter can be a scalar or a two-element vector. A scalar value represents the mean initial temperature in the channel. A vector value represents the initial temperature at the inlet and outlet in the form [inlet, outlet]. The block calculates a linear gradient between the two ports. The inlet and the outlet ports are identified according to the initial flow direction.

Initial moisture specification — Moisture specification

Relative humidity (default) | Specific humidity | Mole fraction | Humidity ratio

Moisture specification, which can be set as relative humidity, specific humidity, water vapor mole fraction, or humidity ratio.

Initial moist air relative humidity — Relative humidity at the start of simulation

0.5 (default) | positive scalar in the range of [0,1] | two-element vector

Relative humidity in the moist air channel at the start of the simulation. The relative humidity is the ratio of the water vapor partial pressure to the water vapor saturation pressure, or the ratio of the water vapor mole fraction to the water vapor mole fraction at saturation.

This parameter can be a scalar or a two-element vector. A scalar value represents the mean initial relative humidity in the channel. A vector value represents the initial relative humidity at the inlet and outlet in the form [inlet, outlet]. The block calculates a linear gradient between the two ports. The inlet and the outlet ports are identified according to the initial flow direction.

Dependencies

To enable this parameter, set **Initial moisture specification** to Relative humidity.

Initial moist air specific humidity — Specific humidity at the start of simulation

0.01 (default) | positive scalar in the range of [0,1] | two-element vector

Specific humidity in the moist air channel at the start of simulation. The specific humidity is the mass fraction of water vapor to the combined total mass of water vapor, trace gas, and dry air.

This parameter can be a scalar or a two-element vector. A scalar value represents the mean initial specific humidity in the channel. A vector value represents the initial specific humidity at the inlet and outlet in the form [inlet, outlet]. The block calculates a linear gradient between the two ports. The inlet and the outlet ports are identified according to the initial flow direction.

Dependencies

To enable this parameter, set **Initial moisture specification** to Specific humidity.

Initial moist air water vapor mole fraction — Mole fraction of water vapor at the start of simulation

0.01 (default) | positive scalar in the range [0,1] | two-element vector

Mole fraction of the water vapor in the moist air channel at the start of simulation. The water vapor mole fraction is relative to the combined molar quantity of water vapor, trace species, and dry air.

This parameter can be a scalar or a two-element vector. A scalar value represents the mean initial vapor mole fraction in the channel. A vector value represents the initial vapor mole fraction at the inlet and outlet in the form [inlet, outlet]. The block calculates a linear gradient between the two ports. The inlet and the outlet ports are identified according to the initial flow direction.

Dependencies

To enable this parameter, set **Initial moisture specification** to Mole fraction.

Initial moist air humidity ratio – Humidity ratio at the start of simulation

0.01 (default) | positive scalar in the range [0,1] | two-element vector

Humidity ratio in the moist air channel at the start of the simulation. The humidity ratio is the ratio of the mass of water vapor to the mass of dry air and trace gas.

This parameter can be a scalar or a two-element vector. A scalar value represents the mean initial humidity ratio in the channel. A vector value represents the initial humidity ratio at the inlet and outlet in the form [inlet, outlet]. The block calculates a linear gradient between the two ports. The inlet and the outlet ports are identified according to the initial flow direction.

Dependencies

To enable this parameter, set **Initial moisture specification** to Humidity ratio.

Initial trace gas specification – Measurement type of trace gas

Mass fraction (default) | Mole fraction

Measurement type of trace gas.

Initial moist air trace gas mass fraction – Amount of trace gas in the moist air channel

0.001 (default) | positive scalar in the range of [0,1] | two-element vector

Amount of trace gas in the moist air channel by mass fraction at the start of the simulation. The mass fraction is relative to the combined total mass of water vapor, trace gas, and dry air.

This parameter can be a scalar or a two-element vector. A scalar value represents the mean trace gas mass fraction in the channel. A vector value represents the initial trace gas mass fraction at the inlet and outlet in the form [inlet, outlet]. The block calculates a linear gradient between the two ports. The inlet and the outlet ports are identified according to the initial flow direction.

This parameter is ignored if the **Trace gas model** parameter in the Moist Air Properties (MA) block is set to None.

Dependencies

To enable this parameter, set **Initial trace gas specification** to Mass fraction.

Initial moist air trace gas mole fraction – Mole fraction of trace gas at the start of simulation

0.001 (default) | positive scalar in the range of [0,1] | two-element vector

Amount of trace gas in the moist air channel by mole fraction at the start of the simulation. The mole fraction is relative to the combined molar total of water vapor, trace gas, and dry air.

This parameter can be a scalar or a two-element vector. A scalar value represents the mean trace gas mole fraction in the channel. A vector value represents the initial trace gas mole fraction at the inlet and outlet in the form [inlet, outlet]. The block calculates a linear gradient between the two ports. The inlet and the outlet ports are identified according to the initial flow direction.

This parameter is ignored if the **Trace gas model** parameter in the Moist Air Properties (MA) block is set to None.

Dependencies

To enable this parameter, set **Initial trace gas specification** to Mole fraction.

Relative humidity at saturation — Relative humidity point of condensation

1 (default) | positive scalar in the range of [0,1]

Relative humidity point of condensation. Condensation occurs above this value. A value greater than 1 indicates a supersaturated vapor.

References

- [1] *2013 ASHRAE Handbook - Fundamentals*. American Society of Heating, Refrigerating and Air-Conditioning Engineers, Inc., 2013.
- [2] Braun, J. E., S. A. Klein, and J. W. Mitchell. "Effectiveness Models for Cooling Towers and Cooling Coils." *ASHRAE Transactions* 95, no. 2, (June 1989): 164-174.
- [3] Çengel, Yunus A. *Heat and Mass Transfer: A Practical Approach*. 3rd ed, McGraw-Hill, 2007.
- [4] Ding, X., Eppe J.P., Lebrun, J., Wasacz, M. "Cooling Coil Model to be Used in Transient and/or Wet Regimes. Theoretical Analysis and Experimental Validation." *Proceedings of the Third International Conference on System Simulation in Buildings* (1990): 405-411.
- [5] Mitchell, John W., and James E. Braun. *Principles of Heating, Ventilation, and Air Conditioning in Buildings*. Wiley, 2013.
- [6] Shah, R. K., and Dušan P. Sekulić. *Fundamentals of Heat Exchanger Design*. John Wiley & Sons, 2003.
- [7] White, Frank M. *Fluid Mechanics*. 6th ed, McGraw-Hill, 2009.

Extended Capabilities

C/C++ Code Generation

Generate C and C++ code using Simulink® Coder™.

See Also

Thermostatic Expansion Valve (2P) | Condenser Evaporator (TL-2P) | Heat Exchanger (TL-MA) | E-NTU Heat Transfer | Heat Exchanger (G-TL) | Heat Exchanger (TL-TL)

Introduced in R2019a

Condenser Evaporator (TL-2P)

Models heat exchange between a thermal liquid network and a network that can undergo phase change

Library: Simscape / Fluids / Fluid Network Interfaces / Heat Exchangers

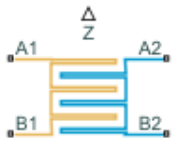

Description

The Condenser Evaporator (TL-MA) block models a heat exchanger with one thermal liquid network, which flows between ports **A1** and **B1**, and one two-phase fluid network, which flows between ports **A2** and **B2**. The heat exchanger can act as a condenser or as an evaporator. The fluid streams can be aligned in parallel, counter, or cross-flow configurations.

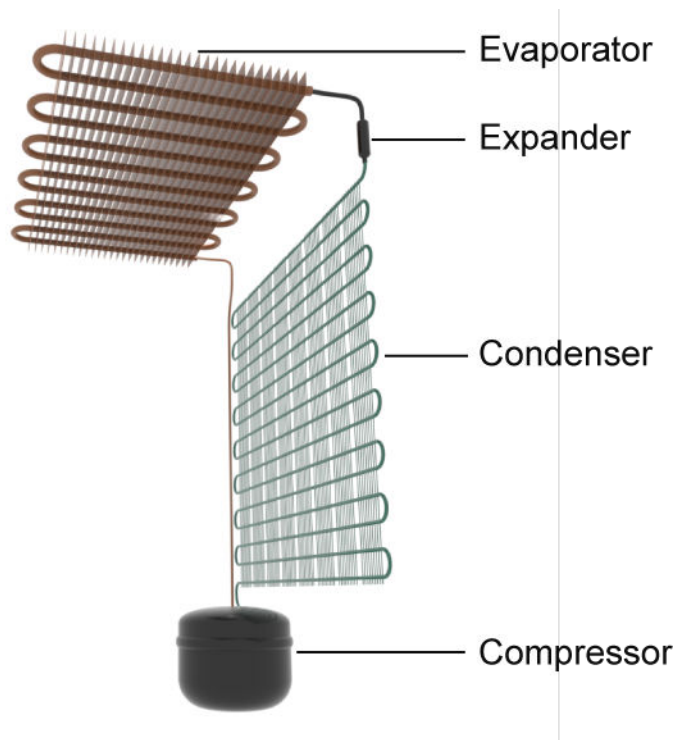

Example Heat Exchanger for Refrigeration Applications

You can model the thermal liquid side as flow within tubes, flow around the two-phase fluid tubing, or by an empirical, generic parameterization.

The block uses the Effectiveness-NTU (E-NTU) method to model heat transfer through the shared wall. Fouling on the exchanger walls, which increases thermal resistance and reduces the heat exchange between the two fluids, is also modeled. You can also optionally model fins on both the thermal liquid and two-phase fluid sides. Pressure loss due to viscous friction on both sides of the exchanger can be modeled analytically or by generic parameterization, which you can use to tune to your own data.

You can model the two-phase fluid side as flow within a tube or a set of tubes. The two-phase fluid tubes use a boundary-following model to track the sub-cooled liquid (L), vapor-liquid mixture (M), and super-heated vapor (V) in three zones. The relative amount of space a zone occupies in the system is called a *zone length fraction* within the system.

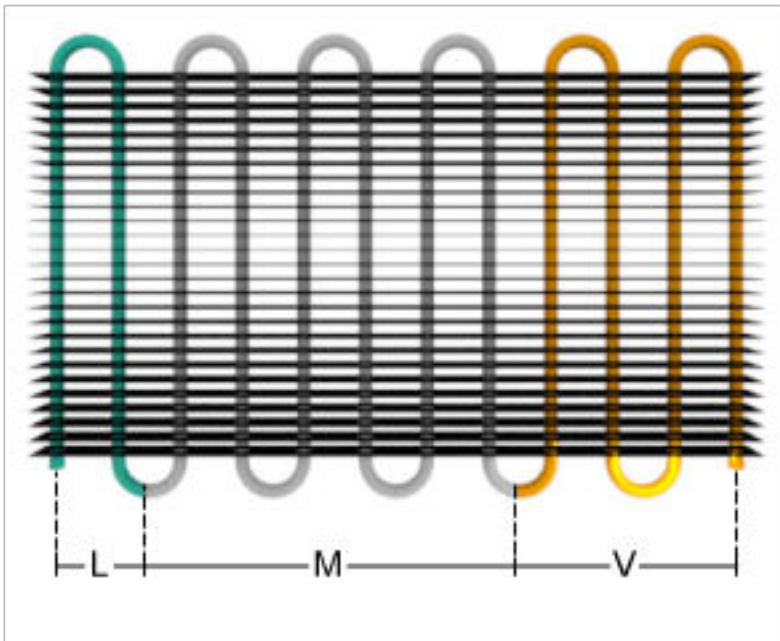

Zone Length Fractions in the Two-Phase Fluid Piping

The sum of the zone length fractions in the two-phase fluid tubing equals 1. Port **Z** returns the zone length fractions as a vector of physical signals for each of the three phases: [L, M, V].

Heat Exchanger Configuration

The heat exchanger effectiveness is based on the selected heat exchanger configuration, the fluid properties in each phase, the tube geometry and flow configuration on each side of the exchanger, and the usage and size of fins.

Flow Arrangement

The **Flow arrangement** parameter assigns the relative flow paths between the two sides:

- Parallel flow indicates the fluids are moving in the same direction.
- Counter flow indicates the fluids are moving in parallel, but opposite directions.
- Cross flow indicates the fluids are moving perpendicular to each other.

Thermal Mixing

When **Flow arrangement** is set to Cross flow, use the **Cross flow arrangement** parameter to indicate whether the two-phase fluid or thermal liquid flows are separated into multiple paths by baffles or walls. Without these separations, the flow can mix freely and is considered *mixed*. Both fluids, one fluid, or neither fluid can be mixed in the cross-flow arrangement. Mixing homogenizes the fluid temperature along the direction of flow of the second fluid, and varies perpendicular to the second fluid flow.

Unmixed flows vary in temperature both along and perpendicular to the flow path of the second fluid.

Sample Cross-Flow Configurations

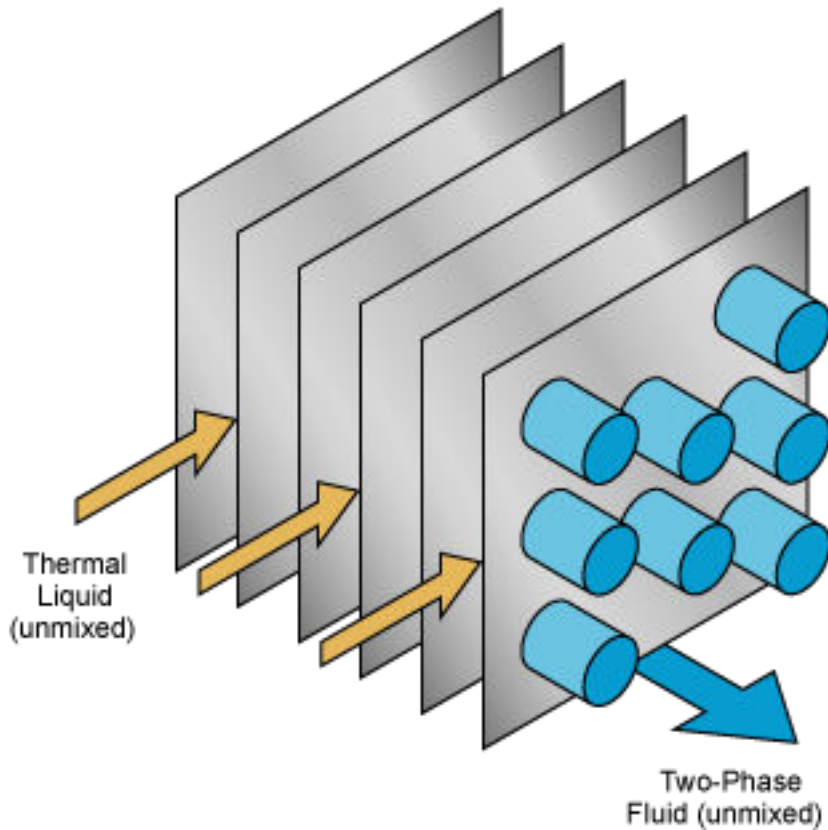
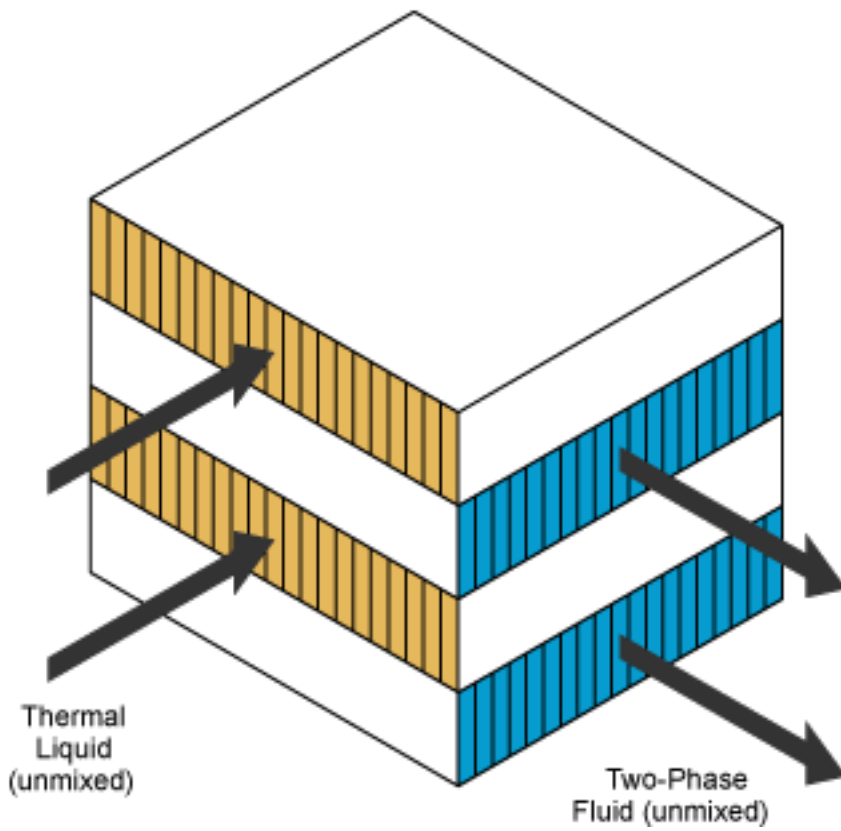

Note that the flow direction during simulation does not impact the selected flow arrangement setting. The ports on the block do not reflect the physical positions of the ports in the physical heat exchanger system.

All flow arrangements are single-pass, which means that the fluids do not make multiple turns in the exchanger for additional points of heat transfer. To model a multi-pass heat exchanger, you can arrange multiple Condenser Evaporator (TL-2P) blocks in series or in parallel.

For example, to achieve a two-pass configuration on the two-phase fluid side and a single-pass configuration on the thermal liquid side, you can connect the two-phase fluid sides in series and the thermal liquid sides to the same input in parallel (such as two Mass Flow Rate Source blocks with half of the total mass flow rate), as shown below.

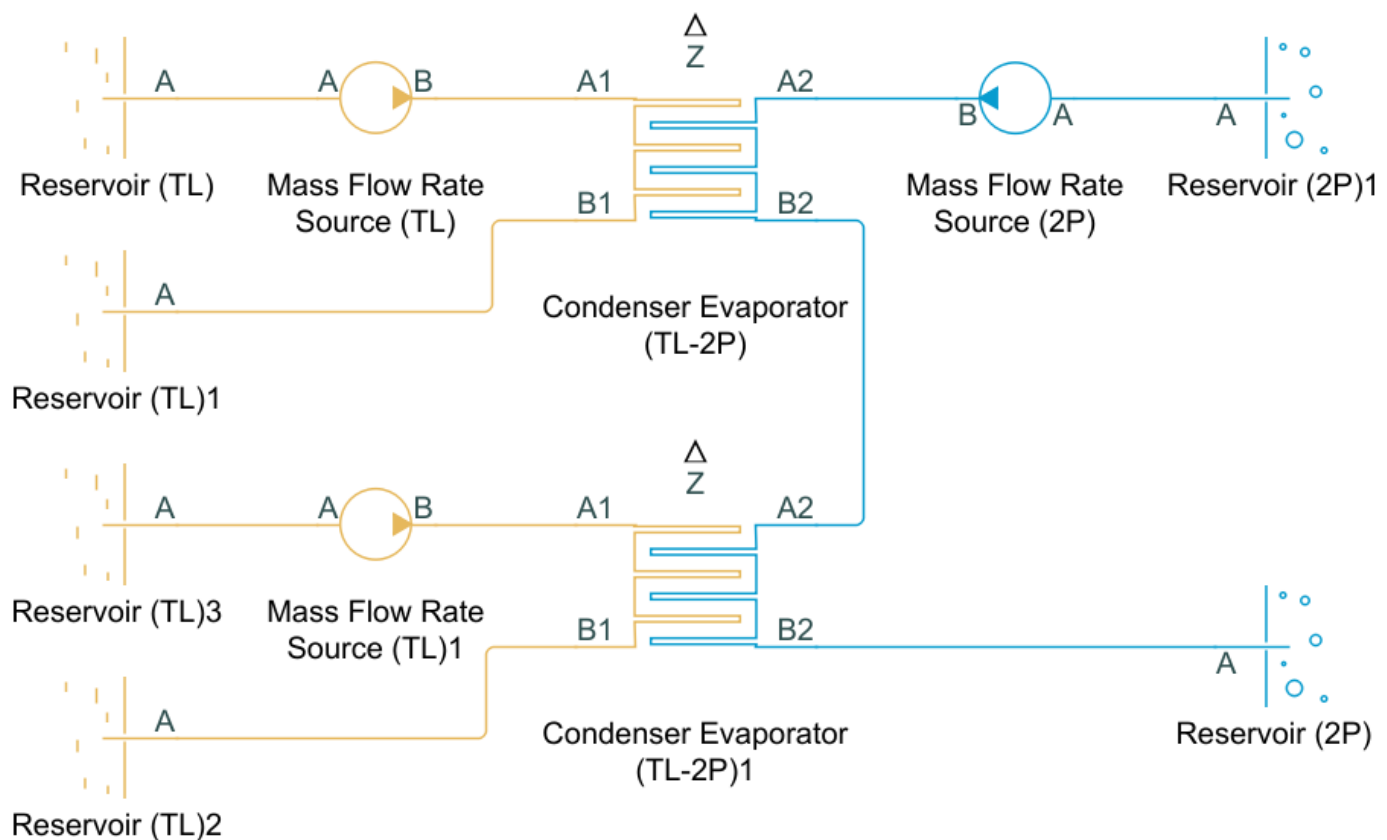

Flow Geometry

The **Flow geometry** parameter sets the thermal liquid flow arrangement as either inside a tube or set of tubes, or perpendicular to a tube bank. You can also specify an empirical, generic configuration. The two-phase fluid always flows inside a tube or set of tubes.

When **Flow geometry** is set to Flow perpendicular to bank of circular tubes, use the **Tube bank grid arrangement** parameter to define the two-phase fluid tube bank alignment as either Inline or Staggered. The red, downward-pointing arrow indicates the direction of thermal liquid flow. The Inline figure also shows the **Number of tube rows along flow direction** and the **Number of tube segments in each tube row** parameters. Here, *flow direction* refers to the

thermal liquid flow, and *tube* refers to the two-phase fluid tubing. The **Length of each tube segment in a tube row** parameter is indicated in the Staggered figure.

Number of tube segments
in each tube row

Inline

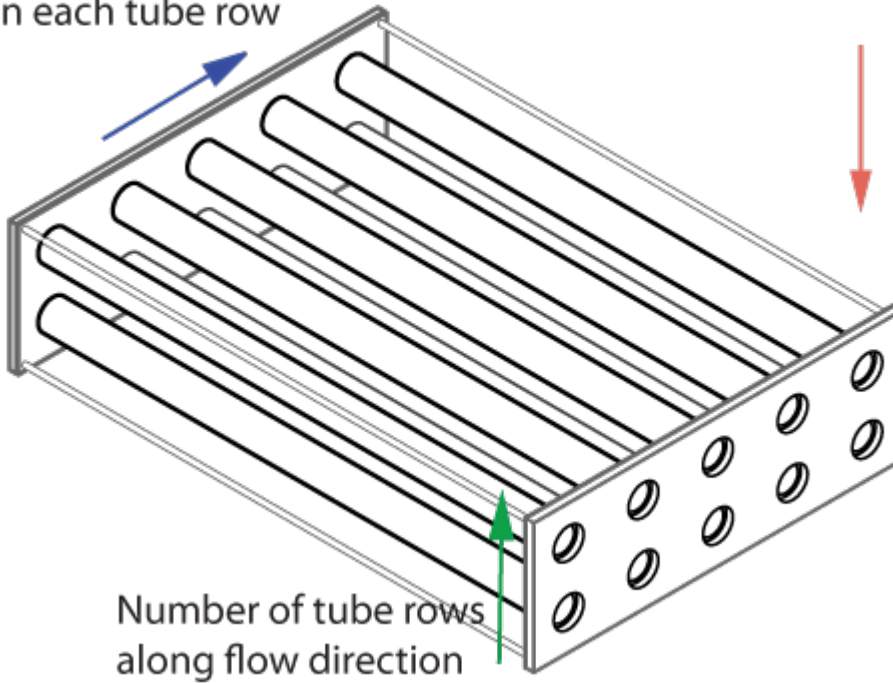

Staggered

Length of each tube
segment in a tube row

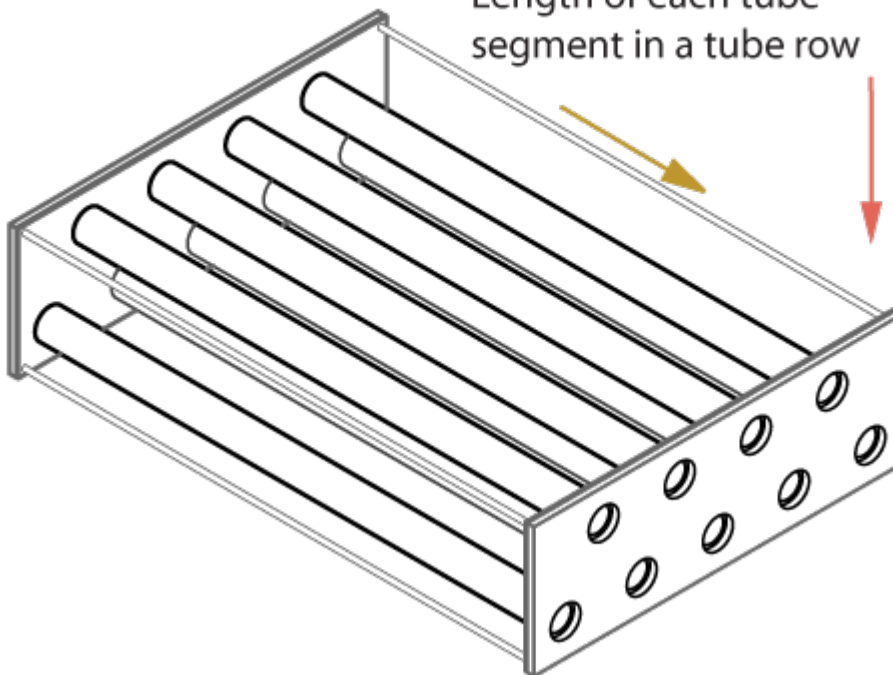

Fins

The heat exchanger configuration is without fins when the **Total fin surface area** parameter is set to 0 m². Fins introduce additional surface area for additional heat transfer. Each fluid side has a separate fin area.

Effectiveness-NTU Heat Transfer

The heat transfer rate is calculated for each fluid phase. In accordance with the three fluid zones that occur on the two-phase fluid side of the heat exchanger, the heat transfer rate is calculated in three sections.

The heat transfer in a zone is calculated as:

$$Q_{zone} = \epsilon C_{\text{Min}}(T_{\text{In},2\text{P}} - T_{\text{In},\text{TL}}),$$

where:

- C_{Min} is the lesser of the heat capacity rates of the two fluids in that zone. The heat capacity rate is the product of the fluid specific heat, c_p , and the fluid mass flow rate. C_{Min} is always positive.
- $T_{\text{In},2\text{P}}$ is the zone inlet temperature of the two-phase fluid.
- $T_{\text{In},\text{TL}}$ is the zone inlet temperature of the thermal liquid.
- ϵ is the heat exchanger effectiveness.

Effectiveness is a function of the heat capacity rate and the number of transfer units, NTU , and also varies based on the heat exchanger flow arrangement, which is discussed in more detail in “Effectiveness by Flow Arrangement” on page 1-508. The NTU is calculated as:

$$NTU = \frac{z}{C_{\text{Min}}R},$$

where:

- z is the individual zone length fraction.
- R is the total thermal resistance between the two flows, due to convection, conduction, and any fouling on the tube walls:

$$R = \frac{1}{U_{2\text{P}}A_{\text{Th},2\text{P}}} + \frac{F_{2\text{P}}}{A_{\text{Th},2\text{P}}} + R_{\text{W}} + \frac{F_{\text{TL}}}{A_{\text{Th},\text{TL}}} + \frac{1}{U_{\text{TL}}A_{\text{Th},\text{TL}}},$$

where:

- U is the convective heat transfer coefficient of the respective fluid. This coefficient is discussed in more detail in “Two-Phase Fluid Correlations” on page 1-509 and “Thermal Liquid Correlations” on page 1-511.
- F is the **Fouling factor** on the two-phase fluid or thermal liquid side, respectively.
- R_{W} is the **Thermal resistance through heat transfer surface**.
- A_{Th} is the heat transfer surface area of the respective side of the exchanger. A_{Th} is the sum of the wall surface area, A_{W} , and the **Total fin surface area**, A_{F} :

$$A_{\text{Th}} = A_{\text{W}} + \eta_{\text{F}}A_{\text{F}},$$

where η_F is the **Fin efficiency**.

The total heat transfer rate between the fluids is the sum of the heat transferred in the three zones by the subcooled liquid (Q_L), liquid-vapor mixture (Q_M), and superheated vapor (Q_V):

$$Q = \sum Q_Z = Q_L + Q_M + Q_V.$$

Effectiveness by Flow Arrangement

The heat exchanger effectiveness varies according to its flow configuration and the mixing in each fluid. Below are the formulations for effectiveness calculated in the liquid and vapor zones for each configuration. The effectiveness is $\varepsilon = 1 - \exp(-NTU)$ for all configurations in the mixture zone.

- When **Flow arrangement** is set to Parallel flow:

$$\varepsilon = \frac{1 - \exp[-NTU(1 + C_R)]}{1 + C_R}$$

- When **Flow arrangement** is set to Counter flow:

$$\varepsilon = \frac{1 - \exp[-NTU(1 - C_R)]}{1 - C_R \exp[-NTU(1 - C_R)]}$$

- When **Flow arrangement** is set to Cross flow and **Cross flow arrangement** is set to Both fluids unmixed:

$$\varepsilon = 1 - \exp\left\{\frac{NTU^{0.22}}{C_R} [\exp(-C_R NTU^{0.78}) - 1]\right\}$$

- When **Flow arrangement** is set to Cross flow and **Cross flow arrangement** is set to Both fluids mixed:

$$\varepsilon = \left[\frac{1}{1 - \exp(-NTU)} + \frac{C_R}{1 - \exp(-C_R NTU)} - \frac{1}{NTU} \right]^{-1}$$

When one fluid is mixed and the other unmixed, the equation for effectiveness depends on the relative heat capacity rates of the fluids. When **Flow arrangement** is set to Cross flow and **Cross flow arrangement** is set to either Thermal Liquid 1 mixed & Two-Phase Fluid 2 unmixed or Thermal Liquid 1 unmixed & Two-Phase Fluid 2 mixed:

- When the fluid with C_{\max} is mixed and the fluid with C_{\min} is unmixed:

$$\varepsilon = \frac{1}{C_R} (1 - \exp\{-C_R [1 - \exp(-NTU)]\})$$

- When the fluid with C_{\min} is mixed and the fluid with C_{\max} is unmixed:

$$\varepsilon = 1 - \exp\left\{-\frac{1}{C_R} [1 - \exp(-C_R NTU)]\right\}$$

C_R denotes the ratio between the heat capacity rates of the two fluids:

$$C_R = \frac{C_{\min}}{C_{\max}}.$$

Two-Phase Fluid Correlations

Heat Transfer Coefficient

The convective heat transfer coefficient varies according to the fluid Nusselt number:

$$U = \frac{Nu k}{D_H},$$

where:

- Nu is the zone mean Nusselt number, which depends on the flow regime.
- k is the fluid phase thermal conductivity.
- D_H is tube hydraulic diameter.

For turbulent flows in the subcooled liquid or superheated vapor zones, the Nusselt number is calculated with the Gnielinski correlation:

$$Nu = \frac{\frac{f_D}{8}(Re - 1000)Pr}{1 + 12.7\sqrt{\frac{f_D}{8}}(Pr^{2/3} - 1)},$$

where:

- Re is the fluid Reynolds number.
- Pr is the fluid Prandtl number.

For turbulent flows in the liquid-vapor mixture zone, the Nusselt number is calculated with the Cavallini-Zecchin correlation:

$$Nu = \frac{a Re_{SL}^b Pr_{SL}^c \left\{ \left[\left(\sqrt{\frac{\rho_{SL}}{\rho_{SV}}} - 1 \right) x_{Out} + 1 \right]^{1+b} - \left[\left(\sqrt{\frac{\rho_{SL}}{\rho_{SV}}} - 1 \right) x_{In} + 1 \right]^{1+b} \right\}}{(1+b) \left(\sqrt{\frac{\rho_{SL}}{\rho_{SV}}} - 1 \right) (x_{Out} - x_{In})}.$$

where:

- Re_{SL} is the Reynolds number of the saturated liquid.
- Pr_{SL} is the Prandtl number of the saturated liquid.
- ρ_{SL} is the density of the saturated liquid.
- ρ_{SV} is the density of the saturated vapor.
- $a = 0.05$, $b = 0.8$, and $c = 0.33$.

For laminar flows, the Nusselt number is set by the **Laminar flow Nusselt number** parameter.

For transitional flows, the Nusselt number is a blend between the laminar and turbulent Nusselt numbers.

Empirical Nusselt Number Formulation

When the **Heat transfer coefficient model** parameter is set to Colburn equation, the Nusselt number for the subcooled liquid and superheated vapor zones is calculated by the empirical the Colburn equation:

$$\text{Nu} = a\text{Re}^b\text{Pr}^c,$$

where a , b , and c are defined in the **Coefficients [a, b, c] for $a\text{Re}^b\text{Pr}^c$ in liquid zone** and **Coefficients [a, b, c] for $a\text{Re}^b\text{Pr}^c$ in vapor zone** parameters.

The Nusselt number for liquid-vapor mixture zones is calculated with the Cavallini-Zecchin equation, with the coefficients specified in the **Coefficients [a, b, c] for $a\text{Re}^b\text{Pr}^c$ in mixture zone** parameter.

Pressure Loss

The pressure loss due to viscous friction varies depending on flow regime and configuration. The calculation uses the overall density, which is the total two-phase fluid mass divided by the total two-phase fluid volume.

For turbulent flows, when the Reynolds number is above the **Turbulent flow lower Reynolds number limit**, the pressure loss due to friction is calculated in terms of the Darcy friction factor. The pressure differential between port **A2** and the internal node I2 is:

$$p_{A2} - p_{I2} = \frac{f_{D,A}\dot{m}_{A2}|\dot{m}_{A2}|}{2\rho D_H A_{CS}^2} \left(\frac{L + L_{Add}}{2} \right),$$

where:

- \dot{m}_{A2} is the total flow rate through port **A2**.
- $f_{D,A}$ is the Darcy friction factor, according to the Haaland correlation:

$$f_{D,A2} = \left\{ -1.8 \log_{10} \left[\frac{6.9}{\text{Re}_{A2}} + \left(\frac{\epsilon_R}{3.7 D_H} \right)^{1.11} \right] \right\}^{-2},$$

where ϵ_R is the two-phase fluid pipe **Internal surface absolute roughness**. Note that the friction factor is dependent on the Reynolds number, and is calculated at both ports for each liquid.

- L is the **Total length of each tube** on the two-phase fluid side.
- L_{Add} is the two-phase fluid **Aggregate equivalent length of local resistances**, which is the equivalent length of a tube that introduces the same amount of loss as the sum of the losses due to other local resistances in the tube.
- A_{CS} is the total tube cross-sectional area.

The pressure differential between port **B2** and internal node I2 is:

$$p_{B2} - p_{I2} = \frac{f_{D,B}\dot{m}_{B2}|\dot{m}_{B2}|}{2\rho D_H A_{CS}^2} \left(\frac{L + L_{Add}}{2} \right),$$

where \dot{m}_{B2} is the total flow rate through port **B2**.

The Darcy friction factor at port **B2** is:

$$f_{D,B2} = \left\{ -1.8 \log_{10} \left[\frac{6.9}{\text{Re}_{B2}} + \left(\frac{\epsilon_R}{3.7 D_H} \right)^{1.11} \right] \right\}^{-2}.$$

For laminar flows, when the Reynolds number is below the **Laminar flow upper Reynolds number limit**, the pressure loss due to friction is calculated in terms of the **Laminar friction constant for**

Darcy friction factor, λ . λ is a user-defined parameter when **Tube cross-section** is set to **Generic**, otherwise, the value is calculated internally. The pressure differential between port **A2** and internal node I2 is:

$$p_{A2} - p_{I2} = \frac{\lambda \mu \dot{m}_{A2}}{2 \rho D_{H,ACS}^2} \left(\frac{L + L_{Add}}{2} \right),$$

where μ is the two-phase fluid dynamic viscosity. The pressure differential between port **B2** and internal node I2 is:

$$p_{B2} - p_{I2} = \frac{\lambda \mu \dot{m}_{B2}}{2 \rho D_{H,ACS}^2} \left(\frac{L + L_{Add}}{2} \right).$$

For transitional flows, the pressure differential due to viscous friction is a smoothed blend between the values for laminar and turbulent pressure losses.

Empirical Pressure Loss Formulation

When **Pressure loss model** is set to **Pressure loss coefficient**, the pressure losses due to viscous friction are calculated with an empirical pressure loss coefficient, ξ .

The pressure differential between port **A2** and internal node I2 is:

$$p_{A2} - p_{I2} = \frac{1}{2} \xi \frac{\dot{m}_{A2} |\dot{m}_{A2}|}{2 \rho A_{CS}^2}.$$

The pressure differential between port **B2** and internal node I2 is:

$$p_{B2} - p_{I2} = \frac{1}{2} \xi \frac{\dot{m}_{B2} |\dot{m}_{B2}|}{2 \rho A_{CS}^2}.$$

Thermal Liquid Correlations

Heat Transfer Coefficient for Flows Inside One or More Tubes

When the thermal liquid **Flow geometry** is set to **Flow inside one or more tubes**, the Nusselt number is calculated according to the Gnielinski correlation in the same manner as two-phase subcooled liquid or superheated vapor. See "Heat Transfer Coefficient" on page 1-509 for more information.

Heat Transfer Coefficient for Flows Across a Tube Bank

When the thermal liquid **Flow geometry** is set to **Flow perpendicular to bank of circular tubes**, the Nusselt number is calculated based on the Hagen number, Hg , and depends on the **Tube bank grid arrangement** setting:

$$Nu = \begin{cases} 0.404 L q^{1/3} \left(\frac{Re+1}{Re+1000} \right)^{0.1}, & \text{Inline} \\ 0.404 L q^{1/3}, & \text{Staggered} \end{cases}$$

where:

$$Lq = \begin{cases} 1.18Pr \left(\frac{4l_T/\pi - D}{l_L} \right) Hg(Re), & \text{Inline} \\ 0.92Pr \left(\frac{4l_T/\pi - D}{l_D} \right) Hg(Re), & \text{Staggered with } l_L \geq D \\ 0.92Pr \left(\frac{4l_T l_L/\pi - D^2}{l_L l_D} \right) Hg(Re), & \text{Staggered with } l_L < D \end{cases}$$

- D is the **Tube outer diameter**.
- l_L is the **Longitudinal tube pitch (along flow direction)**, the distance between the tube centers along the flow direction. *Flow direction* refers to the thermal liquid flow.
- l_T is the **Transverse tube pitch (perpendicular to flow direction)**, shown in the figure below. The transverse pitch is the distance between the centers of the two-phase fluid tubing in one row.
- l_D is the diagonal tube spacing, calculated as $l_D = \sqrt{\left(\frac{l_T}{2}\right)^2 + l_L^2}$.

For more information on calculating the Hagen number, see [3].

The longitudinal and transverse pitch distances are the same for both grid bank arrangement types.

Cross-Section of Two-Phase Fluid Tubing with Pitch Measurements

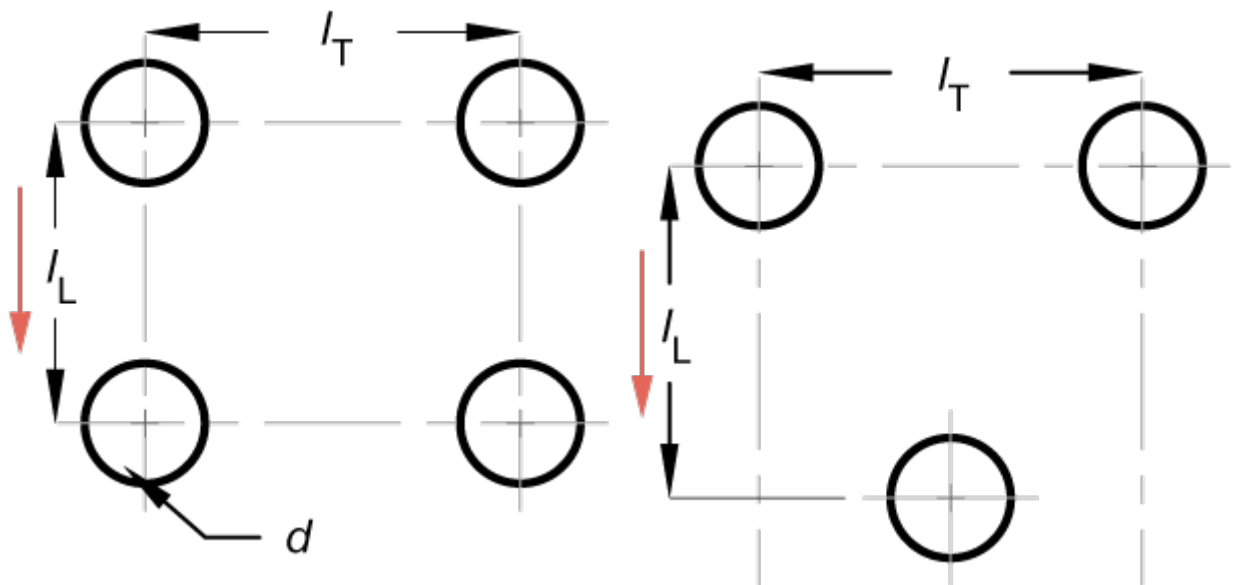

Empirical Nusselt Number Formulation

When the **Heat transfer coefficient model** is set to Colburn equation or when **Flow geometry** is set to Generic, the Nusselt number is calculated by the empirical the Colburn equation:

$$Nu = aRe^bPr^c,$$

where a , b , and c are the values defined in the **Coefficients [a, b, c] for a*Re^b*Pr^c** parameter.

Pressure Loss for Flow Inside Tubes

When the thermal liquid **Flow geometry** is set to Flow inside one or more tubes, the pressure loss is calculated in the same manner as for two-phase flows, with the respective Darcy friction factor, density, mass flow rates, and pipe lengths of the thermal liquid side. See "Pressure Loss" on page 1-510 for more information.

Pressure Loss for Flow Across Tube Banks

When the thermal liquid **Flow geometry** is set to Flow perpendicular to bank of circular tubes, the Hagen number is used to calculate the pressure loss due to viscous friction. The pressure differential between port **A1** and internal node I1 is:

$$p_{A1} - p_{I1} = \frac{1}{2} \frac{\mu^2 N_R}{\rho D^2} \text{Hg}(\text{Re}),$$

where:

- μ_{TL} is the fluid dynamic viscosity.
- N_R is the **Number of tube rows along flow direction**. This is the number of two-phase fluid tube rows along the thermal liquid flow direction.

The pressure differential between port **B1** and internal node I1 is:

$$p_{B1} - p_{I1} = \frac{1}{2} \frac{\mu^2 N_R}{\rho D^2} \text{Hg}(\text{Re}).$$

Empirical Pressure Loss Formulation

When the **Pressure loss model** is set to Euler number per tube row or when **Flow geometry** is set to Generic, the pressure loss due to viscous friction is calculated with a pressure loss coefficient, in terms of the Euler number, Eu :

$$Eu = \frac{\xi}{N_R},$$

where ξ is the empirical pressure loss coefficient.

The pressure differential between port **A1** and internal node I1 is:

$$p_{A1} - p_{I1} = \frac{1}{2} N_R Eu \frac{\dot{m}_{A1} |\dot{m}_{A1}|}{2\rho A_{CS}^2}.$$

The pressure differential between port **B1** and internal node I1 is:

$$p_{B1} - p_{I1} = \frac{1}{2} N_R Eu \frac{\dot{m}_{B1} |\dot{m}_{B1}|}{2\rho A_{CS}^2}.$$

Conservation Equations

Two-Phase Fluid

The total mass accumulation rate in the two-phase fluid is defined as:

$$\frac{dM_{2P}}{dt} = \dot{m}_{A2} + \dot{m}_{B2},$$

where:

- M_{2P} is the total mass of the two-phase fluid.
- \dot{m}_{A2} is the mass flow rate of the fluid at port **A2**.
- \dot{m}_{B2} is the mass flow rate of the fluid at port **B2**.

The flow is positive when flowing into the block through the port.

The energy conservation equation relates the change in specific internal energy to the heat transfer by the fluid:

$$M_{2P} \frac{du_{2P}}{dt} + u_{2P}(\dot{m}_{A2} + \dot{m}_{B2}) = \phi_{A2} + \phi_{B2} - Q,$$

where:

- u_{2P} is the two-phase fluid specific internal energy.
- ϕ_{A2} is the energy flow rate at port **A2**.
- ϕ_{B2} is the energy flow rate at port **B2**.
- Q is heat transfer rate, which is positive when leaving the two-phase fluid volume.

Thermal Liquid

The total mass accumulation rate in the thermal liquid is defined as:

$$\frac{dM_{TL}}{dt} = \dot{m}_{A1} + \dot{m}_{B1}.$$

The energy conservation equation is:

$$M_{TL} \frac{du_{TL}}{dt} + u_{TL}(\dot{m}_{A1} + \dot{m}_{B1}) = \phi_{A1} + \phi_{B1} + Q,$$

where:

- ϕ_{A1} is the energy flow rate at port **A1**.
- ϕ_{B1} is the energy flow rate at port **B1**.

The heat transferred to or from the thermal liquid, Q , is equal to the heat transferred from or to the two-phase fluid.

Ports

Conserving

A1 — Thermal liquid port

thermal liquid

Inlet or outlet port associated with the thermal liquid.

B1 — Thermal liquid port

thermal liquid

Inlet or outlet port associated with the thermal liquid.

A2 — Two-phase fluid port

two-phase fluid

Inlet or outlet port associated with the two-phase fluid.

B2 — Two-phase fluid port

two-phase fluid

Inlet or outlet port associated with the two-phase fluid.

Output**Z — Two-phase fluid zone length fractions**

physical signal

Three-element vector of the zone length fractions in the two-phase fluid channel, returned as a physical signal. The vector takes the form [L, M, V], where L is the sub-cooled liquid, M is the liquid-vapor mixture, and V is the superheated vapor.

Parameters**Configuration****Flow arrangement — Flow path alignment**

Cross flow (default) | Parallel flow | Counter flow

Flow path alignment between heat exchanger sides. The available flow arrangements are:

- `Parallel flow`. The flows run in the same direction.
- `Counter flow`. The flows run parallel to each other, in the opposite directions.
- `Cross flow`. The flows run perpendicular to each other.

Cross flow arrangement — Thermal mixing condition in each of the flow channels

Both fluids unmixed (default) | Both fluids mixed | Thermal Liquid 1 mixed & Two-Phase Fluid 2 unmixed | Thermal Liquid 1 unmixed & Two-Phase Fluid 2 mixed

Select whether each of the fluids can mix in its channel. Mixed flow means that the fluid is free to move in the transverse direction as it travels along the flow path. Unmixed flow means that the fluid is restricted to travel only along the flow path. For example, a side with fins is considered an unmixed flow.

Dependencies

To enable this parameter, set **Flow arrangement** to `Cross flow`.

Thermal resistance through heat transfer surface — Wall thermal resistance

0 K/kW (default) | positive scalar

Thermal resistance of the wall separating the two sides of the heat exchanger. The wall thermal resistance, wall fouling, and the fluid convective heat transfer coefficient influence the amount of heat transferred between the flows.

Cross-sectional area at port A1 — Flow area at port A1

0.01 m² (default) | positive scalar

Flow area at the thermal liquid port **A1**.

Cross-sectional area at port B1 — Flow area at port B1

0.01 m² (default) | positive scalar

Flow area at the thermal liquid port **B1**.

Cross-sectional area at port A2 — Flow area at port A2

0.01 m² (default) | positive scalar

Flow area at the two-phase fluid port **A2**.

Cross-sectional area at port B2 — Flow area at port B2

0.01 m² (default) | positive scalar

Flow area at the two-phase fluid port **B2**.

Thermal Liquid 1**Flow geometry — Thermal liquid flow configuration**

Flow inside one or more tubes (default) | Flow perpendicular to bank of circular tubes | Generic

Thermal liquid flow path. The flow can run externally over a set of tubes or internal to a tube or set of tubes. You can also specify a generic parameterization based on empirical values.

Number of tubes — Number of thermal liquid tubes

25 (default) | positive scalar

Number of thermal liquid tubes. More tubes result in higher pressure losses due to viscous friction, but a larger amount of surface area for heat transfer.

Dependencies

To enable this parameter, set **Flow geometry** to Flow inside one or more tubes.

Total length of each tube — Total length of each thermal liquid tube

1 m (default) | positive scalar

Total length of each thermal liquid tube.

Dependencies

To enable this parameter, set **Flow geometry** to Flow inside one or more tubes.

Tube cross section — Cross-sectional shape of a tube

Circular (default) | Rectangular | Annular | Generic

Cross-sectional shape of one tube. Set to Generic to specify an arbitrary cross-sectional geometry.

Dependencies

To enable this parameter, set **Flow geometry** to Flow inside one or more tubes.

Tube inner diameter — Internal diameter of a single tube

0.05 m (default) | positive scalar

Internal diameter of the cross-section of one tube. The cross-section and diameter are uniform along the tube. The size of the diameter influences the pressure loss and heat transfer calculations.

Dependencies

To enable this parameter, set **Flow geometry** to Flow inside one or more tubes and **Tube cross-section** to Circular.

Tube width — Internal width of a single tube

0.05 m (default) | positive scalar

Internal width of the cross-section of one tube. The cross-section and width are uniform along the tube. The width and height influence the pressure loss and heat transfer calculations.

Dependencies

To enable this parameter, set **Flow geometry** to Flow inside one or more tubes and **Tube cross-section** to Rectangular.

Tube height — Internal height of a single tube

0.05 m (default) | positive scalar

Internal height of one tube. The cross-section and height are uniform along the tube. The width and height influence the pressure loss and heat transfer calculations.

Dependencies

To enable this parameter, set **Flow geometry** parameterization of Flow inside one or more tubes and **Tube cross-section** to Rectangular.

Annulus inner diameter (heat transfer surface) — Smaller diameter of annular cross-section

0.05 m (default) | positive scalar

Smaller diameter of the annular cross-section of one tube. The cross-section and inner diameter are uniform along the tube. The inner diameter influences the pressure loss and heat transfer calculations. Heat transfer occurs through the inner surface of the annulus.

Dependencies

To enable this parameter, set **Flow geometry** parameterization of Flow inside one or more tubes and **Tube cross-section** to Annular.

Annulus outer diameter — Larger diameter of annular cross-section

0.1 m (default) | positive scalar

Larger diameter of the annular cross-section of one tube. The cross-section and outer diameter are uniform along the tube. The outer diameter influences the pressure loss and heat transfer calculations.

Dependencies

To enable this parameter, set **Flow geometry** to Flow inside one or more tubes and **Tube cross-section** to Annular.

Cross-sectional area per tube — Internal flow area in each tube

0.002 m² (default) | positive scalar

Internal flow area of each tube.

Dependencies

To enable this parameter, set **Flow geometry** to Flow inside one or more tubes and **Tube cross-section** to Generic.

Wetted perimeter of tube cross-section for pressure loss — Perimeter of tube cross-section that fluid touches

0.15 m (default) | positive scalar

Perimeter of the tube cross-section that the fluid touches. The cross-section and perimeter are uniform along the tube. This value is applied in pressure loss calculations.

Dependencies

To enable this parameter, set **Flow geometry** to Flow inside one or more tubes and **Tube cross-section** to Generic.

Perimeter of tube cross-section for heat transfer — Perimeter of a single tube for heat transfer calculations

0.15 m (default) | positive scalar

Tube perimeter for heat transfer calculations. This is often the same as the tube perimeter, but in cases such as the annular cross-section, this may be only the inner or outer diameter, depending on the heat-transferring surface. The cross-section and tube perimeter are uniform along the tube.

Dependencies

To enable this parameter, set **Flow geometry** to Flow inside one or more tubes and **Tube cross-section** to Generic.

Pressure loss model — Method of pressure loss calculation due to viscous friction

Correlation for flow inside tubes (default) | Euler number per tube row | Pressure loss coefficient | Correlation for flow over tube bank

Method of pressure loss calculation due to viscous friction. Different models are available for different flow configurations. The settings are:

- Correlation for flow inside tubes. Use this setting to calculate the pressure loss with the Haaland correlation.
- Pressure loss coefficient. Use this setting to calculate the pressure loss based on an empirical loss coefficient.
- Euler number per tube row. Use this setting to calculate the pressure loss based on an empirical Euler number.
- Correlation for flow over tube bank. Use this setting to calculate the pressure loss based on the Hagen number.

The pressure loss models available depend on the **Flow geometry** setting.

Dependencies

When **Flow geometry** is set to Flow inside one or more tubes, **Pressure loss model** can be set to either:

- Pressure loss coefficient.
- Correlation for flow inside tubes.

When **Flow geometry** is set to Flow perpendicular to bank of circular tubes, **Pressure loss model** can be set to either:

- Correlation for flow over tube bank.
- Euler number per tube row.

When **Flow geometry** is set to Generic, the **Pressure loss model** parameter is disabled. Pressure loss is calculated empirically with the **Pressure loss coefficient, $\Delta p / (0.5 \cdot \rho \cdot v^2)$** parameter.

Pressure loss coefficient, $\Delta p / (0.5 \cdot \rho \cdot v^2)$ – Empirical loss coefficient for all pressure losses in the channel

10 (default) | positive scalar

Empirical loss coefficient for all pressure losses in the channel. This value accounts for wall friction and minor losses due to bends, elbows, and other geometry changes in the channel.

The loss coefficient can be calculated from a nominal operating condition or be tuned to fit experimental data. It is defined as:

$$\xi = \frac{\Delta p}{\frac{1}{2} \rho v^2},$$

where Δp is the pressure drop, ρ is the thermal liquid density, and v is the flow velocity.

Dependencies

To enable this parameter, set either:

- **Flow geometry** to Flow inside one or more tubes and **Pressure loss model** to Pressure loss coefficient.
- **Flow geometry** to Generic.

Aggregate equivalent length of local resistances – Combined length of all local resistances in the tubes

0.1 m (default) | positive scalar

Combined length of all local resistances in the tubes. This is the length of tubing that results in the same pressure losses as the sum of all minor losses in the tube due to such things as bends, tees, or unions. A longer equivalent length results in larger pressure losses.

Dependencies

To enable this parameter, set **Flow geometry** to Flow inside one or more tubes and **Pressure loss model** to Correlations for flow inside tubes.

Internal surface absolute roughness – Mean surface roughness height

15e-6 m (default) | positive scalar

Mean height of tube surface defects. A rougher wall results in larger pressure losses in the turbulent regime for pressure loss calculated with the Haaland correlation.

Dependencies

To enable this parameter, set **Flow geometry** to Flow inside one or more tubes and either:

- **Pressure loss model**
- **Heat transfer coefficient model**

to Correlation for flow inside tubes.

Laminar flow upper Reynolds number limit – Largest Reynolds number that indicates laminar flow

2000 (default) | positive scalar

Largest Reynolds number that indicates laminar flow. Between this value and the **Turbulent flow lower Reynolds number limit**, the flow regime is transitional.

Dependencies

To enable this parameter, set **Flow geometry** to Flow inside one or more tubes and **Pressure loss model** to Correlation for flow inside tubes.

Turbulent flow lower Reynolds number limit – Smallest Reynolds number that indicates turbulent flow

4000 (default) | positive scalar

Smallest Reynolds number that indicates turbulent flow. Between this value and the **Laminar flow upper Reynolds number limit**, the flow regime is transitional between the laminar and turbulent regimes.

Dependencies

To enable this parameter, set **Flow geometry** to Flow inside one or more tubes and **Pressure loss model** to Correlation for flow inside tubes.

Laminar friction constant for Darcy friction factor – Coefficient of pressure loss due to viscous friction in laminar flows

64 (default) | positive scalar

Coefficient in pressure loss equations for viscous friction in laminar flows. This parameter is also known as the *shape factor*. The default value corresponds to a circular tube cross-section.

Dependencies

To enable this parameter, set **Flow geometry** to Correlation for flow inside tubes, **Tube cross section** to Generic, and **Pressure loss model** to Correlation for flow inside tubes.

Heat transfer coefficient model – Method of calculating heat transfer coefficient between fluid and wall

Correlation for flow over tube bank (default) | Colburn equation | Correlation for flow inside tubes

Method of calculating the heat transfer coefficient between the fluid and the wall. The available settings are:

- **Colburn equation.** Use this setting to calculate the heat transfer coefficient with user-defined variables a , b , and c of the Colburn equation.
- **Correlation for flow over tube bank.** Use this setting to calculate the heat transfer coefficient based on the tube bank correlation using the Hagen number.
- **Correlation for flow inside tubes.** Use this setting to calculate the heat transfer coefficient for pipe flows with the Gnielinski correlation.

Dependencies

To enable this parameter, set **Flow geometry** to either:

- Flow perpendicular to bank of circular tubes.
- Flow inside one or more tubes.

Coefficients [a, b, c] for $a \cdot \text{Re}^b \cdot \text{Pr}^c$ — Colburn equation coefficients

[0.023, 0.8, 0.33] (default) | three-element vector

Three-element vector containing the empirical coefficients of the Colburn equation. The Colburn equation is a formulation for calculating the Nusselt Number. The general form of the Colburn equation is:

$$\text{Nu} = a \text{Re}^b \text{Pr}^c.$$

When the **Heat transfer coefficient model** is set to Colburn equation and **Flow geometry** is set to Flow inside one or more tubes, or **Flow geometry** is set to Generic, the default Colburn equation is:

$$\text{Nu} = 0.023 \text{Re}^{0.8} \text{Pr}^{1/3}.$$

When the **Heat transfer coefficient model** is set to Colburn equation and **Flow geometry** is set to Flow perpendicular to bank of circular tubes, the default Colburn equation is:

$$\text{Nu} = 0.27 \text{Re}^{0.63} \text{Pr}^{0.36}.$$

Dependencies

To enable this parameter, set:

1 Flow geometry to either:

- Flow inside one or more tubes
- Flow perpendicular to bank of circular tubes

and **Heat transfer coefficient model** to Colburn equation.

2 Flow geometry to Generic.

Laminar flow Nusselt number — Ratio of convective to conductive heat transfer in the laminar flow regime

3.66 (default) | positive scalar

Ratio of convective to conductive heat transfer in the laminar flow regime. The fluid Nusselt number influences the heat transfer rate and depends on the tube cross-section.

Dependencies

To enable this parameter, set **Flow geometry** to Flow inside one or more tubes, **Tube cross-section** to Generic, and **Heat transfer parameterization** to Correlation for flow inside tubes.

Tube bank grid arrangement — Geometrical placement of tube rows in the bank

Inline (default) | Staggered

Alignment of tubes in a tube bank. Rows are either in line with their neighbors, or staggered.

- **Inline:** All tube rows are located directly behind each other.
- **Staggered:** Tubes of the one tube row are located at the gap between tubes of the previous tube row.

Tube alignment influences the Nusselt number and the heat transfer rate.

Dependencies

To enable this parameter, set **Flow geometry** to Flow perpendicular to bank of circular tubes.

Number of tube rows along flow direction — Number of two-phase fluid tube rows in the tube bank

5 (default) | positive scalar

Number of two-phase fluid tube rows in a tube bank. The rows are aligned with the direction of thermal liquid flow.

Dependencies

To enable this parameter, set **Flow geometry** to Flow perpendicular to bank of circular tubes.

Number of tube segments in each tube row — Number of two-phase fluid tubes in each row of the tube bank

5 (default) | positive scalar

Number of two-phase fluid tubes in each row of a tube bank. This measurement is perpendicular to the thermal liquid flow.

Dependencies

To enable this parameter, set **Flow geometry** to Flow perpendicular to bank of circular tubes.

Length of each tube segment in a tube row — Length of each two-phase fluid tube

1 m (default) | positive scalar

Length of each tube that spans a tube row. All tubes in a tube bank are the same length.

Dependencies

To enable this parameter, set **Flow geometry** to Flow perpendicular to bank of circular tubes.

Tube outer diameter — External diameter of a single two-phase fluid tube

0.05 m (default) | positive scalar

Outer diameter of a two-phase fluid tube. The cross-section is uniform along a tube and so the diameter is constant throughout. This value influences the losses in the flow across a tube bank due to viscous friction.

Dependencies

To enable this parameter, set **Flow geometry** to Flow perpendicular to bank of circular tubes.

Longitudinal tube pitch (along flow direction) — Center-to-center distance between two-phase fluid tube rows

0.15 m (default) | positive scalar

Distance between tube centers of the two-phase fluid tubes, aligned with the direction of flow of the thermal liquid.

Dependencies

To enable this parameter, set **Flow geometry** to Flow perpendicular to bank of circular tubes.

Transverse tube pitch (perpendicular to flow direction) — Center-to-center distance between two-phase fluid tubes in a row

0.15 m (default) | positive scalar

Distance between the tube centers in a row of two-phase fluid tubes. This measurement is perpendicular to the thermal liquid flow direction. See “Heat Transfer Coefficient for Flows Across a Tube Bank” on page 1-511 for more information.

Dependencies

To enable this parameter, set **Flow geometry** to Flow perpendicular to bank of circular tubes.

Euler number per tube row, $\Delta p / (N \cdot 0.5 \cdot \rho \cdot v^2)$ — Euler number for each row of the tube bank

10 (default) | positive scalar

Empirical coefficient for pressure drop across one tube row. The Euler number is the ratio between pressure drop and fluid momentum:

$$Eu = \frac{\Delta p}{N \frac{1}{2} \rho v^2},$$

where N is the **Number of tube rows along flow direction**, Δp is the pressure drop, ρ is the thermal liquid mixture density, and v is the flow velocity.

Each tube row is located in a plane perpendicular to the thermal liquid flow.

Dependencies

To enable this parameter, set **Flow geometry** to Flow perpendicular to bank of circular tubes and **Pressure loss model** to Euler number per tube row.

Minimum free-flow area — Smallest total flow area between inlet and outlet

0.01 m² (default) | positive scalar

Smallest total flow area between inlet and outlet. If the channel is a collection of ducts, tubes, slots, or grooves, the minimum free-flow area is the sum of the smallest areas.

Dependencies

To enable this parameter, set **Flow geometry** to Generic.

Heat transfer surface area without fins — Total area of the heat transfer surface excluding fins

2 m² (default) | positive scalar

Total area of the heat transfer surface, excluding fins.

Dependencies

To enable this parameter, set **Flow geometry** to Generic.

Thermal liquid volume inside heat exchanger — Total volume of thermal liquid in the heat exchanger

0.05 m³ (default) | positive scalar

Total volume of thermal liquid in the heat exchanger.

Dependencies

To enable this parameter, set **Flow geometry** to Generic.

Fouling factor — Additional thermal resistance due to fouling deposits

0.1 m²*K/kW (default) | positive scalar

Additional thermal resistance due to fouling layers on the surfaces of the wall. In real systems, fouling deposits grow over time. However, the growth is slow enough to be assumed constant during the simulation.

Total fin surface area — Total heat transfer surface area of all fins

0 m² (default) | positive scalar

Total heat transfer surface area of both sides of all fins. For example, if the fin is rectangular, the surface area is double the area of the rectangle.

The total heat transfer surface area is the sum of the channel surface area and the effective fin surface area, which is the product of the **Fin efficiency** and the **Total fin surface area**.

Fin efficiency — Ratio of fin actual to idea heat transfer rates

0.5 (default) | positive scalar in the range [0,1]

Ratio of actual heat transfer to ideal heat transfer through the fins.

Initial thermal liquid pressure — Moist air pressure at the start of simulation

0.101325 MPa (default) | positive scalar

Thermal liquid pressure at the start of the simulation.

Initial thermal liquid temperature — Temperature at the start of simulation

293.15 K (default) | positive scalar | two-element vector

Temperature in the thermal liquid channel at the start of the simulation. This parameter can be a scalar or a two-element vector. A scalar value represents the mean initial temperature in the channel. A vector value represents the initial temperature at the inlet and outlet in the form [inlet, outlet]. The block calculates a linear gradient between the two ports. The inlet and the outlet ports are identified according to the initial flow direction.

Two-Phase Fluid 2**Number of tubes — Number of two-phase fluid tubes**

25 (default) | positive scalar

Number of two-phase fluid tubes.

Total length of each tube — Total length of each two-phase fluid tube

1 m (default) | positive scalar

Total length of each two-phase fluid tube.

Tube cross section — Cross-sectional shape of a tube

Circular (default) | Rectangular | Annular | Generic

Cross-sectional shape of a tube. Use `Generic` to specify an arbitrary cross-sectional geometry.

Tube inner diameter — Internal diameter of a single tube

0.05 m (default) | positive scalar

Internal diameter of the cross-section of one tube. The cross-section and diameter are uniform along the tube. The size of the diameter influences the pressure loss and heat transfer calculations.

Dependencies

To enable this parameter, set **Tube cross-section** to `Circular`.

Tube width — Internal width of a single tube

0.05 m (default) | positive scalar

Internal width of the cross-section of one tube. The cross-section and width are uniform along the tube. The width and height influence the pressure loss and heat transfer calculations.

Dependencies

To enable this parameter, set **Tube cross-section** to `Rectangular`.

Tube height — Internal height of a single tube

0.05 m (default) | positive scalar

Internal height of one tube. The cross-section and height are uniform along the tube. The width and height influence the pressure loss and heat transfer calculations.

Dependencies

To enable this parameter, set **Tube cross-section** to Rectangular.

Annulus inner diameter (heat transfer surface) – Smaller diameter of annular cross-section

0.05 m (default) | positive scalar

Smaller diameter of the annular cross-section of one tube. The cross-section and inner diameter are uniform along the tube. The inner diameter influences the pressure loss and heat transfer calculations. Heat transfer occurs through the inner surface of the annulus.

Dependencies

To enable this parameter, set **Tube cross-section** to Annular.

Annulus outer diameter – Larger diameter of annular cross-section

0.1 m (default) | positive scalar

Larger diameter of the annular cross-section of one tube. The cross-section and outer diameter are uniform along the tube. The outer diameter influences the pressure loss and heat transfer calculations.

Dependencies

To enable this parameter, set **Tube cross-section** to Annular.

Cross-sectional area per tube – Internal area normal to flow in a single tube

0.002 m² (default) | positive scalar

Internal flow area of each tube.

Dependencies

To enable this parameter, set **Tube cross-section** to Generic.

Wetted perimeter of tube cross-section for pressure loss – Perimeter of tube cross-section that fluid touches

0.15 m (default) | positive scalar

Perimeter of the tube cross-section that the fluid touches. The cross-section and perimeter are uniform along the tube. This value is applied in pressure loss calculations.

Dependencies

To enable this parameter, set **Tube cross-section** to Generic.

Perimeter of tube cross-section for heat transfer – Perimeter of a single tube for heat transfer calculations

0.15 m (default) | positive scalar

Tube perimeter for heat transfer calculations. This is often the same as the tube perimeter, but in cases such as the annular cross-section, this may be only the inner or outer diameter, depending on the heat-transferring surface. The cross-section and tube perimeter are uniform along the tube.

Dependencies

To enable this parameter, set **Tube cross-section** to Generic.

Pressure loss model – Method of pressure loss calculation due to viscous friction

Correlation for flow inside tubes (default) | Pressure loss coefficient

Method of pressure loss calculation due to viscous friction. The settings are:

- **Pressure loss coefficient.** Use this setting to calculate the pressure loss based on an empirical loss coefficient.
- **Correlation for flow inside tubes.** Use this setting to calculate the pressure loss based on the pipe flow correlation.

Pressure loss coefficient, $\Delta p / (0.5 \cdot \rho \cdot v^2)$ – Empirical loss coefficient for all pressure losses in the channel

10 (default)

Empirical loss coefficient for all pressure losses in the channel. This value accounts for wall friction and minor losses due to bends, elbows, and other geometry changes in the channel.

The loss coefficient can be calculated from a nominal operating condition or be tuned to fit experimental data. It is defined as:

$$\xi = \frac{\Delta p}{\frac{1}{2} \rho v^2},$$

where Δp is the pressure drop, ρ is the two-phase fluid density, and v is the flow velocity.

Dependencies

To enable this parameter, set **Pressure loss model** to Pressure loss coefficient.

Aggregate equivalent length of local resistances – Combined length of all local resistances in the tubes

0.1 m (default) | positive scalar

Combined length of all local resistances in the tubes. This is the length of tubing that results in the same pressure losses as the sum of all minor losses in the tube due to such things as bends, tees, or unions. A longer equivalent length results in larger pressure losses.

Dependencies

To enable this parameter, set **Pressure loss model** to Correlation for flow inside tubes.

Internal surface absolute roughness – Mean surface roughness height

15e-6 m (default) | positive scalar

Mean height of tube surface defects. A rougher wall results in larger pressure losses in the turbulent regime for pressure loss calculated with the Haaland correlation.

Dependencies

To enable this parameter, set either:

- **Pressure loss model**
- **Heat transfer coefficient model**

to Correlation for flow inside tubes.

Laminar flow upper Reynolds number limit – Largest Reynolds number that indicates laminar flow

2000 (default) | positive scalar

Largest Reynolds number that indicates laminar flow. Between this value and the **Turbulent flow lower Reynolds number**, the flow regime is transitional.

Dependencies

To enable this parameter, set **Pressure loss model** to Correlations for tubes.

Turbulent flow lower Reynolds number limit – Smallest Reynolds number that indicates turbulent flow

4000 (default) | positive scalar

Smallest Reynolds number that indicates turbulent flow. Between this value and the **Laminar flow upper Reynolds number limit**, the flow regime is transitional.

Dependencies

To enable this parameter, set **Pressure loss model** to Correlations for tubes.

Laminar friction constant for Darcy friction factor – Coefficient of pressure loss due to viscous friction in laminar flows

64 (default) | positive scalar

Coefficient in pressure loss equations for viscous friction in laminar flows. This parameter may also be known as the *shape factor*. The default value corresponds to a circular tube cross-section.

Dependencies

To enable this parameter, set **Pressure loss model** to Correlations for tubes.

Heat transfer coefficient model – Method of calculating heat transfer coefficient between fluid and wall

Correlation for flow inside tubes (default) | Colburn equation

Method of calculating the heat transfer coefficient between the fluid and the wall. The available settings are:

- **Colburn equation.** Use this setting to calculate the heat transfer coefficient with user-defined variables a , b , and c . In the liquid and vapor zones, the heat transfer coefficient is based on the Colburn equation. In the liquid-vapor mixture zone, the heat transfer coefficient is based on the Cavallini-Zecchin equation.
- **Correlation for flow inside tubes.** Use this setting to calculate the heat transfer coefficient for pipe flows. In the liquid and vapor zones, the heat transfer coefficient is calculated with the Gnielinski correlation. In the liquid-vapor mixture zone, the heat transfer coefficient is calculated with the Cavallini-Zecchin equation.

Coefficients [a, b, c] for $a \cdot Re^b \cdot Pr^c$ in liquid zone – Colburn equation coefficients in liquid zone

[.023, .8, .33] (default) | three-element vector of positive scalars

Three-element vector containing the empirical coefficients of the Colburn equation. Each fluid zone has a distinct Nusselt number, which is calculated by the Colburn equation per zone. The general form of the Colburn equation is:

$$\text{Nu} = a\text{Re}^b\text{Pr}^c.$$

Dependencies

To enable this parameter, set **Heat transfer coefficient model** to Colburn equation.

Coefficients [a, b, c] for $a\text{Re}^b\text{Pr}^c$ in mixture zone – Cavallini-Zecchin equation coefficients in mixture zone

[.05, .8, .33] (default) | three-element vector of positive scalars

Three-element vector containing the empirical coefficients of the Cavallini-Zecchin equation. Each fluid zone has a distinct Nusselt number, which is calculated in the mixture zone by the Cavallini-Zecchin equation:

$$\text{Nu} = \frac{a\text{Re}_{\text{SL}}^b\text{Pr}_{\text{SL}}^c \left\{ \left[\left(\sqrt{\frac{\rho_{\text{SL}}}{\rho_{\text{SV}}}} - 1 \right) x_{\text{Out}} + 1 \right]^{1+b} - \left[\left(\sqrt{\frac{\rho_{\text{SL}}}{\rho_{\text{SV}}}} - 1 \right) x_{\text{In}} + 1 \right]^{1+b} \right\}}{(1+b) \left(\sqrt{\frac{\rho_{\text{SL}}}{\rho_{\text{SV}}}} - 1 \right) (x_{\text{Out}} - x_{\text{In}})}.$$

Dependencies

To enable this parameter, set **Heat transfer coefficient model** to Colburn equation.

Coefficients [a, b, c] for $a\text{Re}^b\text{Pr}^c$ in vapor zone – Colburn equation coefficients in vapor zone

[.023, .8, .33] (default) | three-element vector of positive scalars

Three-element vector containing the empirical coefficients of the Colburn equation. Each fluid zone has a distinct Nusselt number, which is calculated by the Colburn equation per zone. The general form of the Colburn equation is:

$$\text{Nu} = a\text{Re}^b\text{Pr}^c.$$

Dependencies

To enable this parameter, set **Heat transfer coefficient model** to Colburn equation.

Laminar flow Nusselt number – Ratio of convective to conductive heat transfer in the laminar flow regime

3.66 (default) | positive scalar

Ratio of convective to conductive heat transfer in the laminar flow regime. The fluid Nusselt number influences the heat transfer rate and depends on the tube cross-section.

Dependencies

To enable this parameter, set **Heat transfer coefficient model** to Correlation for flow inside tubes.

Fouling factor – Additional thermal resistance due to fouling deposits

0.1 m²*K/kW (default) | positive scalar

Additional thermal resistance due to fouling layers on the surfaces of the wall. In real systems, fouling deposits grow over time, however, the growth is slow enough to be assumed constant during the simulation.

Total fin surface area – Total heat transfer surface area of fins

0 m² (default) | positive scalar

Total heat transfer surface area of both sides of all fins. For example, if the fin is rectangular, the surface area is double the area of the rectangle.

The total heat transfer surface area is the sum of the channel surface area and the effective fin surface area, which is the product of the **Fin efficiency** and the **Total fin surface area**.

Fin efficiency – Ratio of fin actual to ideal heat transfer rates

0.5 (default) | positive scalar in the range [0,1]

Ratio of actual heat transfer to ideal heat transfer through the fins.

Initial fluid energy specification – Initial state of the two-phase fluid

Temperature (default) | Vapor quality | Vapor void fraction | Specific enthalpy | Specific internal energy

Quantity used to describe the initial state of the fluid: temperature, vapor quality, vapor void fraction, specific enthalpy, or specific internal energy.

Initial two-phase fluid pressure – Fluid pressure at the start of simulation

0.101325 MPa (default) | positive scalar

Fluid pressure at the start of the simulation.

Initial two-phase fluid temperature – Temperature at the start of simulation

293.15 K (default) | positive scalar | two-element vector

Temperature in the two-phase fluid channel at the start of simulation. This parameter can be a scalar or a two-element vector. A scalar value represents the mean initial temperature in the channel. A vector value represents the initial temperature at the inlet and outlet in the form [inlet, outlet]. The block calculates a linear gradient between the two ports. The inlet and the outlet ports are identified according to the initial flow direction.

Dependencies

To enable this parameter, set **Initial fluid energy specification** to Temperature.

Initial two-phase fluid vapor quality – Vapor mass fraction at the start of simulation

0.5 (default) | positive scalar in the range [0,1] | two-element vector

Vapor mass fraction in the two-phase fluid channel at the start of simulation. This parameter can be a scalar or a two-element vector. A scalar value represents the mean initial vapor quality in the channel. A vector value represents the initial vapor quality at the inlet and outlet in the form [inlet, outlet]. The block calculates a linear gradient between the two ports. The inlet and the outlet ports are identified according to the initial flow direction.

Dependencies

To enable this parameter, set **Initial fluid energy specification** to Vapor quality.

Initial two-phase fluid vapor void fraction – Vapor volume fraction at the start of simulation

0.5 (default) | positive scalar in the range [0,1] | two-element vector

Vapor volume fraction in the two-phase fluid channel at the start of simulation. This parameter can be a scalar or a two-element vector. A scalar value represents the mean initial void fraction in the channel. A vector value represents the initial void fraction at the inlet and outlet in the form [inlet, outlet]. The block calculates a linear gradient between the two ports. The inlet and the outlet ports are identified according to the initial flow direction.

Dependencies

To enable this parameter, set **Initial fluid energy specification** to Vapor void fraction.

Initial two-phase fluid specific enthalpy – Enthalpy per unit mass at the start of simulation

1500 kJ/kg (default) | positive scalar | two-element vector

Enthalpy per unit mass in the two-phase fluid channel at the start of simulation. This parameter can be a scalar or a two-element vector. A scalar value represents the mean initial specific enthalpy in the channel. A vector value represents the initial specific enthalpy at the inlet and outlet in the form [inlet, outlet]. The block calculates a linear gradient between the two ports. The inlet and the outlet ports are identified according to the initial flow direction.

Dependencies

To enable this parameter, set **Initial fluid energy specification** to Specific enthalpy.

Initial two-phase fluid specific internal energy – Internal energy per unit mass at the start of simulation

1500 kJ/kg (default) | positive scalar | two-element vector

Internal energy per unit mass in the two-phase fluid channel at the start of simulation. This parameter can be a scalar or a two-element vector. A scalar value represents the mean initial specific internal energy in the channel. A vector value represents the initial specific internal energy at the inlet and outlet in the form [inlet, outlet]. The block calculates a linear gradient between the two ports. The inlet and the outlet ports are identified according to the initial flow direction.

Dependencies

To enable this parameter, set **Initial fluid energy specification** to Specific internal energy.

References

- [1] *2013 ASHRAE Handbook - Fundamentals*. American Society of Heating, Refrigerating and Air-Conditioning Engineers, Inc., 2013.
- [2] Çengel, Yunus A. *Heat and Mass Transfer: A Practical Approach*. 3rd ed, McGraw-Hill, 2007.
- [3] Shah, R. K., and Dušan P. Sekulić. *Fundamentals of Heat Exchanger Design*. John Wiley & Sons, 2003.
- [4] White, Frank M. *Fluid Mechanics*. 6th ed, McGraw-Hill, 2009.

See Also

Thermostatic Expansion Valve (2P) | Condenser Evaporator (2P-MA) | Heat Exchanger (TL-MA) | E-NTU Heat Transfer | Heat Exchanger (G-TL) | Heat Exchanger (TL-TL)

Introduced in R2020b

Constant Head Tank

Hydraulic reservoir where pressurization and fluid level remain constant regardless of volume change



Library

Low-Pressure Blocks

Description

The Constant Head Tank block represents a pressurized hydraulic reservoir, in which fluid is stored under a specified pressure. The size of the tank is assumed to be large enough to neglect the pressurization and fluid level change due to fluid volume. The block accounts for the fluid level elevation with respect to the tank bottom, as well as for pressure loss in the connecting pipe that can be caused by a filter, fittings, or some other local resistance. The loss is specified with the pressure loss coefficient. The block computes the volume of fluid in the tank and exports it outside through the physical signal port V.

The fluid volume value does not affect the results of simulation. It is introduced merely for information purposes. It is possible for the fluid volume to become negative during simulation, which signals that the fluid volume is not enough for the proper operation of the system. By viewing the results of the simulation, you can determine the extent of the fluid shortage.

For reasons of computational robustness, the pressure loss in the connecting pipe is computed with the equations similar to that used in the Fixed Orifice block:

$$q = \sqrt{\frac{1}{K}} \cdot A_p \sqrt{\frac{2}{\rho}} \cdot \frac{p_{loss}}{(p_{loss}^2 + p_{cr}^2)^{1/4}}$$

$$p_{cr} = K \frac{\rho}{2} \left(\frac{Re_{cr} \cdot \nu}{d} \right)^2$$

The Critical Reynolds number is set to 15.

The pressure at the tank inlet is computed with the following equations:

$$p = p_{elev} - p_{loss} + p_{pr}$$

$$p_{elev} = \rho \cdot g \cdot H$$

$$A_p = \frac{\pi \cdot d^2}{4}$$

where

p	Pressure at the tank inlet
p_{elev}	Pressure due to fluid level
p_{loss}	Pressure loss in the connecting pipe
p_{pr}	Pressurization
ρ	Fluid density
g	Acceleration of gravity
H	Fluid level with respect to the bottom of the tank
K	Pressure loss coefficient
A_p	Connecting pipe area
d	Connecting pipe diameter
q	Flow rate
p_{cr}	Minimum pressure for turbulent flow

Connection T is a hydraulic conserving port associated with the tank inlet. Connection V is a physical signal port. The flow rate is considered positive if it flows into the tank.

Parameters

Pressurization

Gage pressure acting on the surface of the fluid in the tank. It can be created by a gas cushion, membrane, bladder, or piston, as in bootstrap reservoirs. This parameter must be greater than or equal to zero. The default value is 0, which corresponds to a tank connected to atmosphere.

Fluid level

The fluid level with respect to the tank bottom. This parameter must be greater than zero. The default value is 1 m.

Initial fluid volume

The initial volume of fluid in the tank. This parameter must be greater than zero. The default value is 0.2 m^3 .

Inlet pipeline diameter

The diameter of the connecting pipe. This parameter must be greater than zero. The default value is 0.02 m .

Pipeline pressure loss coefficient

The value of the pressure loss coefficient, to account for pressure loss in the connecting pipe. This parameter must be greater than zero. The default value is 1.2.

Ports

The block has the following ports:

T

Hydraulic conserving port associated with the tank inlet.

V

Physical signal port that outputs the volume of fluid in the tank.

Extended Capabilities

C/C++ Code Generation

Generate C and C++ code using Simulink® Coder™.

See Also

Reservoir | Tank

Topics

“Upgrading Simscape Fluids Models Containing Hydraulics (Isothermal) Blocks”

Introduced in R2009a

Counterbalance Valve

Hydraulic counterbalance valve

Library: Simscape / Fluids / Hydraulics (Isothermal) / Valves / Flow Control Valves



Description

Counterbalance valves are used in hydraulic systems working with an overriding (run-away) or suspended load. They are designed to create backpressure at the return line of the actuator to prevent losing control over the load. The following illustration shows a counterbalance valve schematic.

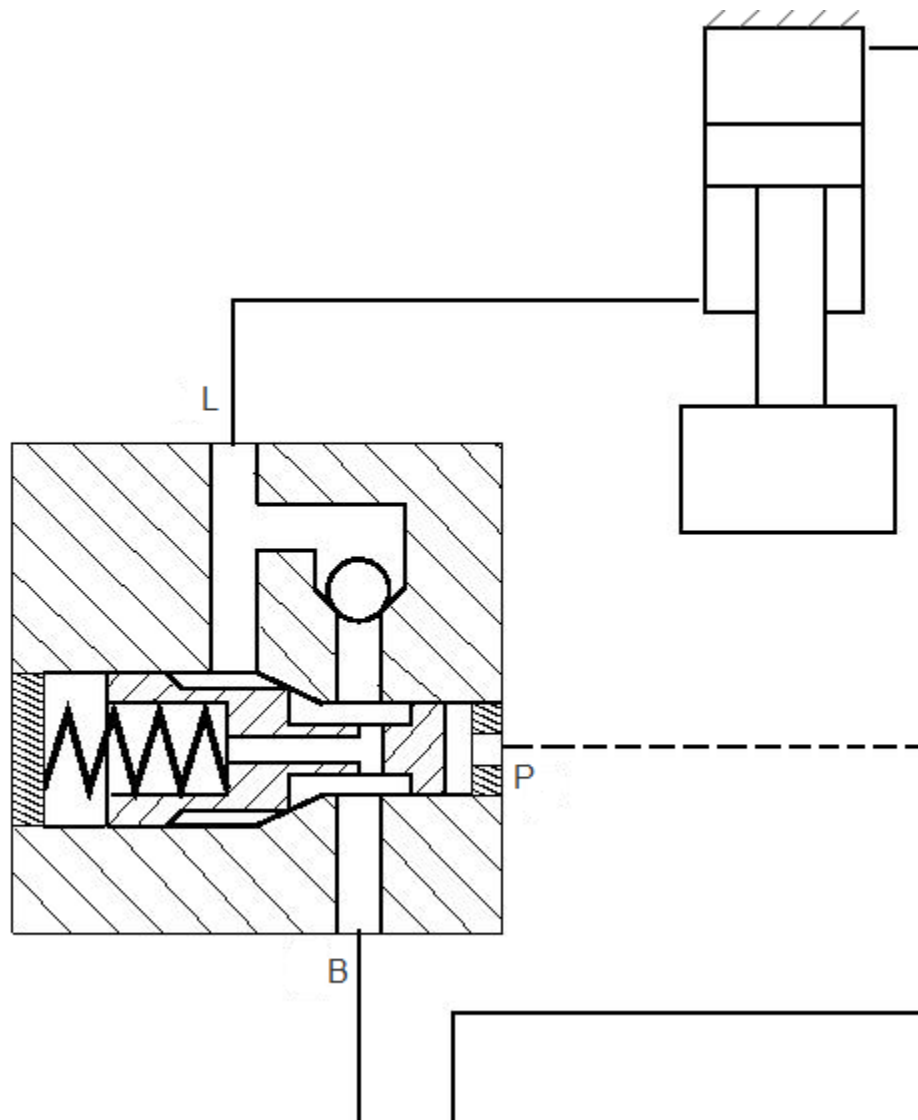

If a directional valve (not shown in the picture) is shifted into position that lowers the load, then the fluid from the rod chamber of the cylinder can exit only if pressure at port P (pilot pressure) and port L (load pressure) create enough force to overcome the spring force and open the valve. In statics, the valve is described with the equation

$$F_0 + c \cdot x = p_{pilot} \cdot A_{pilot} + p_{load} \cdot A_{load} - p_{back} \cdot A_{back} \quad (1-5)$$

where

F_0	Spring setting
c	Spring rate
x	Valve opening
p_{pilot}	Pilot pressure (pressure at port P)
p_{load}	Load pressure (pressure at port L)

p_{back}	Backpressure (pressure at return port B)
A_{pilot}	Valve effective area at pilot port P
A_{load}	Valve effective area at load port L
A_{back}	Valve effective area at return port B

Counterbalance valve, classified by type, is an internally-externally piloted valve because both the pilot pressure and the load pressure tend to open the valve. After minor rearrangements, Equation 1 takes the form

$$p_{set} + c_p \cdot x = p_{pilot} \cdot k_{pilot} + p_{load} - p_{back} \cdot k_{back} \quad (1-6)$$

$$p_{set} = F_0/A_{load}$$

$$c_p = c/A_{load}$$

$$k_{pilot} = A_{pilot}/A_{load}$$

$$k_{back} = A_{back}/A_{load}$$

where

p_{set}	Valve pressure setting
c_p	Spring pressure stiffness (Pa/m)
x	Valve opening
k_{pilot}	Pilot ratio
k_{back}	Backpressure ratio

The valve displacement is determined from Equation 2:

$$x = \frac{p_{pilot} \cdot k_{pilot} + p_{load} - p_{back} \cdot k_{back} - p_{set}}{c_p} \quad (1-7)$$

$$0 \leq x \leq x_{max}$$

where x_{max} is the maximum valve displacement.

The Counterbalance Valve block can be represented as the following structural model.

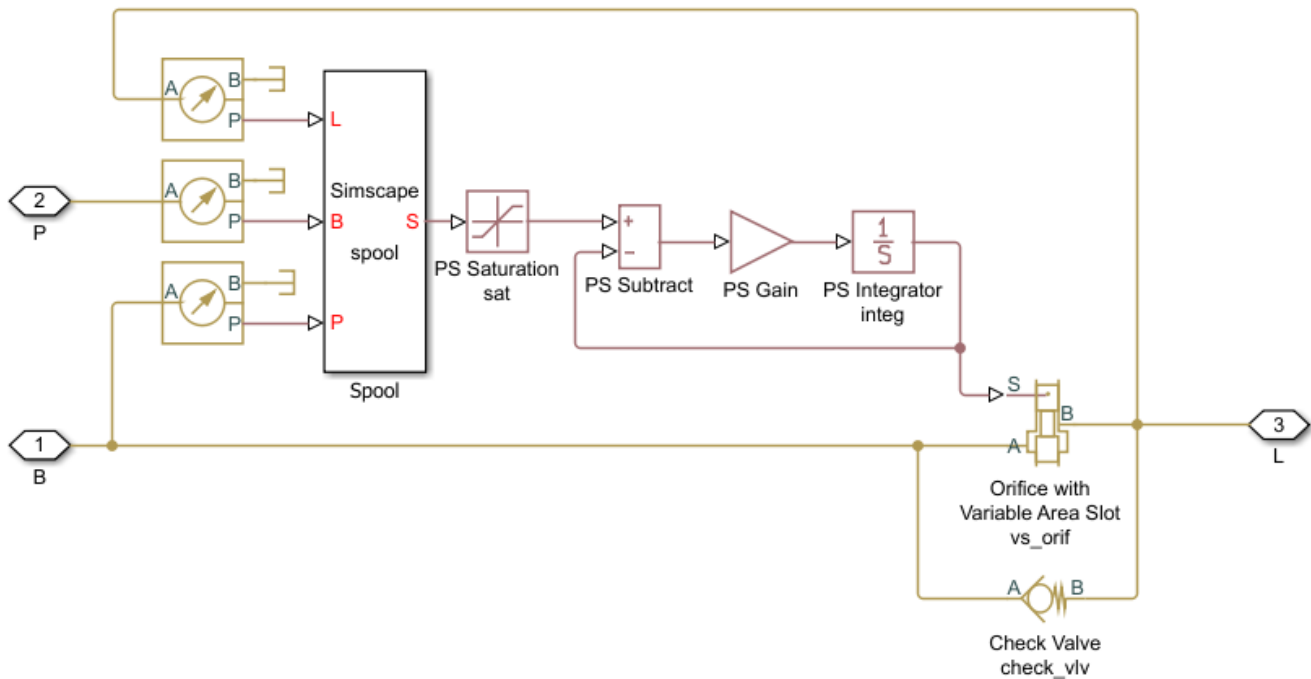

The pressure sensors measure pressure at respective ports and convey their values to the Fcn block, which, together with the PS Saturation block, performs calculations in accordance with Equation 3. The valve displacement is passed through the first order lag block, built of the PS Subtract, PS Gain, and PS Integrator blocks, to account for valve dynamics. The gain of the PS Gain block is set to $1/T$, where T is the time constant. The Variable Orifice and Check Valve blocks simulate the counterbalance valve orifice and check valve. In the actual Counterbalance Valve block model, the operations performed by the sensors and the Fcn block are executed in the block equation section.

The Counterbalance Valve block is essentially a data-sheet-based model. Depending on data listed in the manufacturer's catalogs or data sheets for your particular valve, you can choose one of the following model parameterization options:

- By maximum area and opening — Use this option if the data sheet provides only the orifice maximum area and the control member maximum stroke.
- By area vs. opening table — Use this option if the catalog or data sheet provides a table of the orifice passage area based on the control member displacement.

In the latter case, the PS Saturation block in the structural model is replaced with the PS Lookup Table (1D) block, and you can choose from three interpolation and two extrapolation methods.

Connections L and B are hydraulic conserving ports associated with the load and backpressure ports of the valve. The hydraulic conserving port P is associated with the pilot port. The block positive direction is from port L to port B. Positive pressure at port P opens the valve.

Assumptions and Limitations

- Valve dynamics are approximated by introducing the first order lag between the pressure sensors and the variable orifice control member displacement.

- Inertia, friction, or hydraulic forces acting on the valve control member are not taken into account.

Ports

Conserving

P – Pilot port

isothermal liquid

Hydraulic conserving port associated with the valve pilot port.

L – Load port

isothermal liquid

Hydraulic conserving port associated with the valve load port.

B – Backpressure port

isothermal liquid

Hydraulic conserving port associated with the valve backpressure port.

Parameters

Basic parameters

Valve pressure setting – Cracking pressure at port L

50e5 Pa (default) | positive scalar

The parameter specifies the pressure at port **L** necessary to start opening the valve. The setting is controlled with the valve spring.

Valve spring stiffness – Spring stiffness at port L

1e8 Pa/m (default) | positive scalar

The valve spring pressure stiffness c_p .

Pilot ratio – Ratio of pilot to load chamber area

3 (default) | positive scalar

The ratio between the effective areas of the control member face in the pilot chamber and in the load chamber. This is one of the fundamental valve characteristics in a catalog or data sheet. The default value is 3.

Backpressure ratio – Ratio of back pressure port to load port area

4 (default) | positive scalar

The ratio between the effective area of the control member, onto which the backpressure acts, and the load chamber valve area. There is a wide variety of counterbalance valves with compensated or partially-compensated backpressure. The parameter can take zero value if the valve is completely compensated.

Time constant – Valve opening time constant

0.06 s (default) | positive scalar

The valve dynamics are approximated with the first order lag. This parameter is the time constant of the lag.

Leakage area — Open area of fully closed valve

1e-9 m² (default) | positive scalar

The total area of possible leaks in the completely closed orifice and check valve. The main purpose of the parameter is to maintain numerical integrity of the circuit by preventing a portion of the system from getting isolated after the orifice or check valve is completely closed. The parameter value must be greater than 0.

Variable orifice

Variable orifice parameterization — Method of variation

By maximum area and opening (default) | By area vs. opening table

Select one of the following methods for specifying the orifice:

- **By maximum area and opening** — Provide values for the maximum orifice area and the maximum orifice opening. The passage area is linearly dependent on the control member displacement, that is, the orifice is closed at the initial position of the control member (zero displacement), and the maximum opening takes place at the maximum displacement.
- **By area vs. opening table** — Provide tabulated data of orifice openings and corresponding orifice areas. The passage area is determined by one-dimensional table lookup. You have a choice of two interpolation methods and two extrapolation methods.

Orifice maximum area — Maximum opened area

8e-5 m² (default) | positive scalar

Specify the area of a fully opened orifice. The parameter value must be greater than zero. This parameter is used if **Variable orifice parameterization** is set to By maximum area and opening.

Orifice maximum opening — Maximum opened length

5e-3 m (default) | positive scalar

Specify the maximum displacement of the control member. The parameter value must be greater than zero. This parameter is used if **Variable orifice parameterization** is set to By maximum area and opening.

Tabulated orifice opening — Control member length tabulated data

[-.002, 0, .005, .015] (default) | numerical array

Specify the vector of input values for orifice openings as a one-dimensional array. The input values vector must be strictly increasing. The values can be nonuniformly spaced. The minimum number of values depends on the interpolation method: you must provide at least two values for linear interpolation, at least three values for smooth interpolation. The default values, in meters, are [-2e-3, 0, 5e-3, 15e-3]. This parameter is used if **Variable orifice parameterization** is set to By area vs. opening table. **Tabulated orifice openings** values will be used together with **Tabulated orifice area** values for one-dimensional table lookup.

Tabulated orifice area — Open area tabulated data

[1e-09, 4e-09, 1e-05, 1.02e-05] (default) | numerical array

Specify the vector of orifice areas as a one-dimensional array. The vector must be of the same size as the orifice openings vector. All the values must be positive. The default values, in m², are

[1e-12, 4e-12, 1.e-5, 1.02e-5]. This parameter is used if **Variable orifice parameterization** is set to **By area vs. opening table**.

Interpolation method — Tabular interpolation

Linear (default) | Smooth

This parameter is used if **Variable orifice parameterization** is set to **By area vs. opening table**. Select one of the following interpolation methods for approximating the output value when the input value is between two consecutive grid points:

- **Linear** — Select this option to get the best performance.
- **Smooth** — Select this option to produce a continuous curve with continuous first-order derivatives.

For more information on interpolation algorithms, see the PS Lookup Table (1D) block reference page.

Extrapolation method — Tabular extrapolation

Linear (default) | Nearest

This parameter is used if **Variable orifice parameterization** is set to **By area vs. opening table**. Select one of the following extrapolation methods for determining the output value when the input value is outside the range specified in the argument list:

- **Linear** — Select this option to produce a curve with continuous first-order derivatives in the extrapolation region and at the boundary with the interpolation region.
- **Nearest** — Select this option to produce an extrapolation that does not go above the highest point in the data or below the lowest point in the data.

For more information on extrapolation algorithms, see the PS Lookup Table (1D) block reference page.

Orifice flow discharge coefficient — Orifice discharge coefficient

0.7 (default) | positive scalar

Semi-empirical parameter for orifice capacity characterization. Its value depends on the geometrical properties of the orifice, and usually is provided in textbooks or manufacturer data sheets.

Orifice laminar transition specification — Method for identifying fluid regime transition

Pressure ratio (default) | Reynolds number

Select how the block transitions between the laminar and turbulent regimes:

- **Pressure ratio** — The transition from laminar to turbulent regime is smooth and depends on the value of the **Orifice laminar flow pressure ratio** parameter. This method provides better simulation robustness.
- **Reynolds number** — The transition from laminar to turbulent regime is assumed to take place when the Reynolds number reaches the value specified by the **Orifice critical Reynolds number** parameter.

Orifice laminar flow pressure ratio — Pressure ratio at fluid regime transition

0.999 (default) | positive scalar

Pressure ratio at which the flow transitions between laminar and turbulent regimes. The default value is 0.999. This parameter is visible only if the **Orifice laminar transition specification** parameter is set to Pressure ratio.

Orifice critical Reynolds number — Upper limit to laminar flow

12 (default) | positive scalar

The maximum Reynolds number for laminar flow. The value of the parameter depends on the orifice geometrical profile. You can find recommendations on the parameter value in hydraulics textbooks. The default value is 12. This parameter is visible only if the **Orifice laminar transition specification** parameter is set to Reynolds number.

Check valve

Check valve maximum passage area — Maximum valve open area

$1e-4 \text{ m}^2$ (default) | positive scalar

Valve passage maximum cross-sectional area.

Check valve cracking pressure — Threshold for valve opening

$0.3e5 \text{ Pa}$ (default) | positive scalar

Pressure level at which the orifice of the valve starts to open.

Check valve maximum opening pressure — Valve maximum pressure

$1.2e5 \text{ Pa}$ (default) | positive scalar

Pressure differential across the valve needed to fully open the valve. Its value must be higher than the cracking pressure. The default value is $1.2e5 \text{ Pa}$.

Check valve flow discharge coefficient — Discharge coefficient

0.7 (default)

Semi-empirical parameter for valve capacity characterization. Its value depends on the geometrical properties of the orifice, and usually is provided in textbooks or manufacturer data sheets. The default value is 0.7.

Check valve laminar transition specification — Method for identifying fluid regime transition

Pressure ratio (default) | Reynolds number

Select how the block transitions between the laminar and turbulent regimes:

- **Pressure ratio** — The transition from laminar to turbulent regime is smooth and depends on the value of the **Check valve laminar flow pressure ratio** parameter. This method provides better simulation robustness.
- **Reynolds number** — The transition from laminar to turbulent regime is assumed to take place when the Reynolds number reaches the value specified by the **Check valve critical Reynolds number** parameter.

Check valve laminar flow pressure ratio — Pressure ratio at fluid regime transition

0.999 (default) | positive scalar

Pressure ratio at which the flow transitions between laminar and turbulent regimes. This parameter is visible only if the **Check valve laminar transition specification** parameter is set to Pressure ratio.

Check valve critical Reynolds number — Upper limit to laminar flow through check valve

12 (default) | positive scalar

The maximum Reynolds number for laminar flow. The transition from laminar to turbulent regime is assumed to take place when the Reynolds number reaches this value. The value of the parameter depends on the orifice geometrical profile. You can find recommendations on the parameter value in hydraulics textbooks. The default value is 12. This parameter is visible only if the **Check valve laminar transition specification** parameter is set to Reynolds number.

Extended Capabilities

C/C++ Code Generation

Generate C and C++ code using Simulink® Coder™.

See Also

Counterbalance Valve (IL) | Check Valve | Variable Orifice

Topics

“Hydraulic Actuator with Counterbalance Valve”

“Upgrading Simscape Fluids Models Containing Hydraulics (Isothermal) Blocks”

Introduced in R2012b

Counterbalance Valve (IL)

High-pressure regulation valve in an isothermal liquid system

Library: Simscape / Fluids / Isothermal Liquid / Valves & Orifices / Flow Control Valves



Description

The Counterbalance Valve (IL) block models a normally closed pressure control valve in an isothermal liquid network. A counterbalance valve is commonly used when high-pressure events are expected or when controlled manipulation at high pressures is required, such as hydraulic overloading or lowering suspended loads. The valve functions under a force balance between a spring and the backing pressure at port **B** and the load pressure at port **L**. When the monitored pressure line, the *pilot pressure* at port **P**, exceeds the pressure at port **B**, the valve begins to open.

There is no flow between ports **B** and **P** or between ports **L** and **P**.

Valve Opening

The counterbalance valve operates under the force balance:

$$p_{pilot}A_{pilot} + p_{load}A_{load} = p_{back}A_{back} + F_{set},$$

where:

- p_{pilot} is the pressure at port **P**.
- p_{load} is the pressure at port **L**.
- p_{back} is the pressure at port **B**.
- F_{set} is the accumulated force due to the spring and preloading at port **B**.

The port areas A_{pilot} , A_{load} , and A_{back} are set by the **Pilot ratio**:

$$R_{pilot} = \frac{A_{pilot}}{A_{load}},$$

and the **Back pressure ratio**:

$$R_{back} = \frac{A_{back}}{A_{load}}.$$

A ratio of 4:1 or 3:1 is typical for counterbalance valves.

The preset force, F_{set} , represents the spring preloading and spring force at port **B**, which are characterized as a **Set pressure differential**, p_{set} :

$$F_{set} = p_{set}A_{load}.$$

Opening Parameterization

The linear parameterization of the valve area, for normally open valves, is:

$$A_{valve} = \hat{p}(A_{leak} - A_{max}) + A_{max},$$

and for normally closed valves is:

$$A_{valve} = \hat{p}(A_{max} - A_{leak}) + A_{leak}.$$

The control compensator normalized pressure, \hat{p} , is:

$$\hat{p} = \frac{(p_{load} + p_{pilot}R_{pilot} - p_{back}R_{back}) - p_{set}}{(p_{max} - p_{set})},$$

where:

- p_{set} is the **Set pressure differential**.
- p_{max} is the **Maximum opening pressure differential**.

The normalized check valve pressure is:

$$\hat{p} = \frac{p_{control} - p_{cracking}}{p_{max} - p_{cracking}}.$$

where:

- $p_{cracking}$ is the **Cracking pressure differential**.
- p_{max} is the check valve **Maximum opening pressure differential**.

At the extremes of the control and check valve pressure ranges, you can maintain numerical robustness in your simulation by adjusting the block **Smoothing factor**. With a nonzero smoothing factor, a smoothing function is applied to every calculated pressure, but primarily influences the simulation at the extremes of these ranges.

When the **Smoothing factor**, s , is nonzero, a smoothed, normalized pressure is instead applied to the valve area:

$$\hat{p}_{smoothed} = \frac{1}{2} + \frac{1}{2}\sqrt{\hat{p}^2 + \left(\frac{s}{4}\right)^2} - \frac{1}{2}\sqrt{(\hat{p} - 1)^2 + \left(\frac{s}{4}\right)^2},$$

In the **Tabulated data** parameterization, the smoothed, normalized pressure is also used when the smoothing factor is nonzero with linear interpolation and nearest extrapolation.

Ports

Conserving

L – Liquid port

isothermal liquid

Load port and liquid exit port from the valve.

B – Liquid port

isothermal liquid

Back pressure port and liquid entry port to the valve.

P – Pressure port

isothermal liquid

Control, or *pilot*, pressure port. When the combined pressure at **P** and **B** exceeds the backing and spring pressures, the check valve between ports **B** and **L** opens.

Parameters**Model Parameterization****Opening parameterization – Opening parameterization**

Linear (default) | Tabulated data

Method of modeling the opening of the valve. The opening is either parametrized linearly, which correlates the opening area to the control member opening stroke, by user-supplied data that correlate the valve opening area to the pressure differential over the valve.

Set pressure differential – Initial spring compression pressure

5 MPa (default) | positive scalar

Pressure contribution of the compressed spring before valve operation.

Maximum opening pressure differential – Maximum compensator valve pressure

6 MPa (default) | positive scalar

The maximum compensator valve pressure.

Maximum opening area – Load orifice maximum open area8e-5 m² (default) | positive scalar

Maximum open area of the orifice in the load line. Internally, this orifice is connected in parallel with the load line check valve. The orifice and check valve can have different cross-sectional areas.

Dependencies

To enable this parameter, set **Valve parameterization** to Linear.

Leakage area – Gap area when valve is in fully closed position1e-10 m² (default) | positive scalar

Sum of all gaps when the valve is in the fully closed position. Any area smaller than this value is saturated to the specified leakage area. This contributes to numerical stability by maintaining continuity in the flow.

Opening area vector – Vector of opening areas[1e-10, 2e-05, 4e-05, 6e-05, 8e-05, .0001] m² (default) | 1-by-n vector

Vector of valve opening areas for the tabular parameterization of the valve opening area. The vector elements must correspond one-to-one with the elements in the **Pressure differential vector** parameter. The elements are listed in ascending order and must be greater than 0.

Dependencies

To enable this parameter, set **Valve parameterization** to Tabulated data - Area vs. control member travel.

Pressure differential vector – Vector of pressure drop values

5 : 0.2 : 6 MPa (default) | 1-by-*n* vector

Vector of pressure differential values for the tabular parameterization of the valve opening area. The vector elements must correspond one-to-one with the elements in the **Opening area** parameter. The elements are listed in ascending order and must be greater than 0.

Dependencies

To enable this parameter, set **Valve parameterization** to Tabulated data.

Pilot ratio – Pilot area ratio

3 (default) | positive scalar

Ratio of the pilot port area to the load port area.

Back pressure ratio – Back pressure area ratio

4 (default) | positive scalar

Ratio of the back pressure port area to the load port area.

Discharge coefficient – Discharge coefficient

0.64 (default) | positive scalar

Correction factor that accounts for discharge losses in theoretical flows.

Critical Reynolds number – Upper Reynolds number limit for laminar flow

150 (default) | positive scalar

Upper Reynolds number limit for laminar flow through the valve.

Opening dynamics – Whether to introduce flow lag due to orifice opening

Off (default) | On

Whether to account for transient effects to the fluid system due to opening the valve. Setting **Opening dynamics** to On approximates the opening conditions by introducing a first-order lag in the pressure response. The **Opening time constant** also impacts the modeled opening dynamics.

Smoothing factor – Numerical smoothing factor

0.01 (default) | positive scalar

Continuous smoothing factor that introduces a layer of gradual change to the flow response when the valve is in near-open or near-closed positions. Set this value to a nonzero value less than one to increase the stability of your simulation in these regimes.

Opening time constant – Orifice opening time constant

0.1 s (default) | positive scalar

Constant that captures the time required for the fluid to reach steady-state conditions when opening or closing the valve from one position to another. This parameter impacts the modeled opening dynamics.

Dependencies

To enable this parameter, set **Opening dynamics** to 0n.

Check Valve

Cracking pressure differential – Set pressure for check valve operation

0.01 MPa (default) | positive scalar

Pressure differential value that triggers the valve to open.

Maximum opening pressure differential – Maximum pressure in valve

0.1 MPa (default) | positive scalar

Maximum valve pressure. This value bounds the pressures at the valve exit to maintain physical values during simulation.

Maximum opening area – Maximum open area

1e-4 m² (default) | positive scalar

Maximum open area of the check valve in the load line. Internally, this check valve is connected in parallel with a load line orifice. The orifice and check valve can have different areas.

See Also

Pressure Compensator Valve (IL) | Pressure-Reducing 3-Way Valve (IL) | Pilot-Operated Check Valve (IL) | Shuttle Valve (IL)

Introduced in R2020a

Cylinder Cushion

Cushion in hydraulic cylinders

Library: Simscape / Fluids / Hydraulics (Isothermal) / Hydraulic Cylinders



Description

The Cylinder Cushion block models a hydraulic cylinder cushion, the device that decelerates the cylinder rod near the end of the stroke by restricting the flow rate leaving the cylinder chamber. The figure shows a typical design of a cylinder cushion [1] on page 1-556.

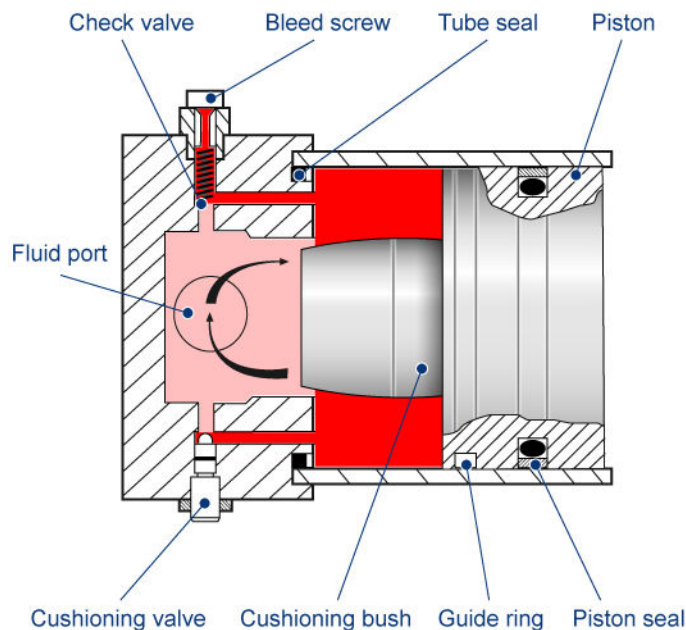

As the piston moves toward the cap (to the left in the figure), the cushioning bush enters the chamber in the cap and creates an additional resistance to the fluid leaving the chamber. The bush profile determines the desired deceleration. Near the end of the stroke, the fluid flows through the gap between the bush and the cap and through the cushioning valve with constant cross-sectional area. The check valve located between the chambers allows free flow to the piston chamber to ease the piston breakaway from the end position.

The block is implemented as a structural model that replicates a cushioning device, as shown in this diagram.

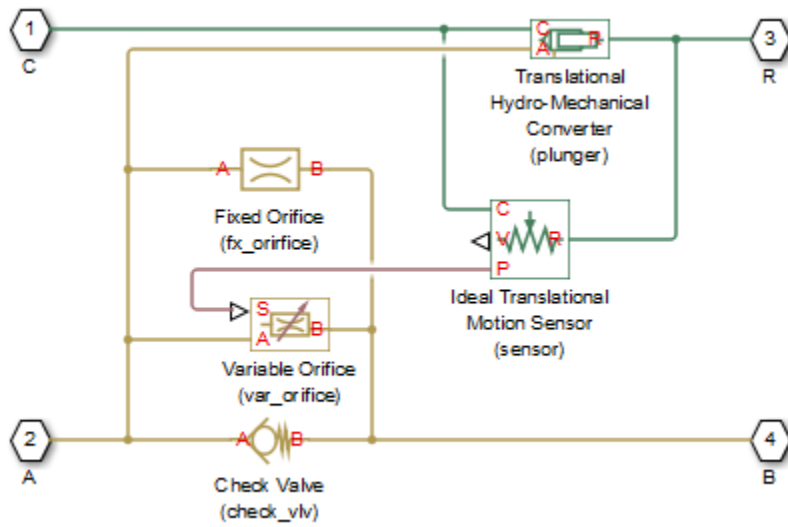

The Variable Orifice block represents a variable gap between the bush and the cavity machined in the end cap. The lookup table of the Variable Orifice block implements the relationship between the orifice area and the piston displacement. The Fixed Orifice and the Check Valve blocks simulate the cushioning valve and the check valve installed between chambers. The Translational Hydro-Mechanical Converter represents a plunger created by the bush and the cavity. The Ideal Translational Motion Sensor block monitors the piston displacement and conveys it (with the initial piston position accounted) to the Variable Orifice block. The names assigned to the nested blocks in the model are shown in parentheses.

The block develops a cushioning effect for the flow rate from port B to port A. The check valve in the block is oriented from port **A** to port **B**.

You can use this block with any of the cylinder blocks in the library to model a single-acting or double-acting cylinder with cushion. The following diagram shows the model of a double-sided hydraulic cylinder with cushion built from a Double-Acting Hydraulic Cylinder block and two Cylinder Cushion blocks.

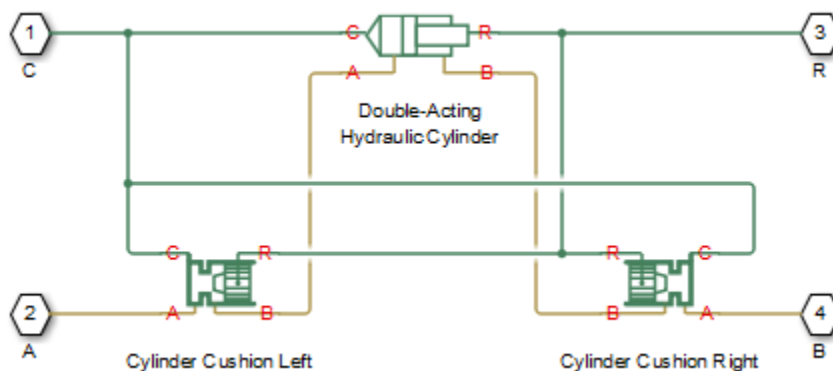

You can adjust the cushioning effect by changing the area of the fixed orifice and the profile of the cushioning bush (variable orifice). Specify the profile using the one-dimensional lookup table of the orifice area versus piston displacement. The next figure shows a typical configuration of a double-

acting cylinder with the double-sided cushioning, similar to the model shown in the block diagram above.

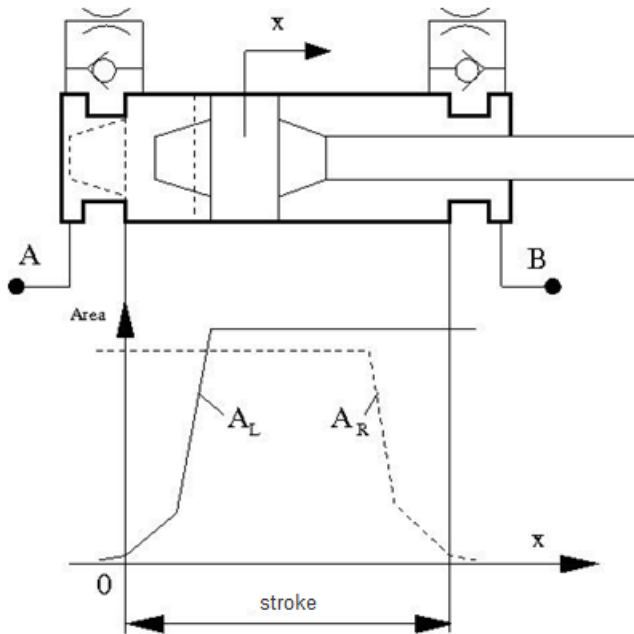

To ensure cushioning on both sides of the stroke, set the variable orifice area of the left cushion (A_L) and the right cushion (A_R) similar to the profile shown in the figure. The origin of the plot is located at the position where the piston touches the cap. If the cylinder acts in the negative direction, the piston displacements are negative, and you must make the profile specification in the fourth quadrant.

The following figure shows a typical motion diagram of a cylinder with the double-sided cushioning.

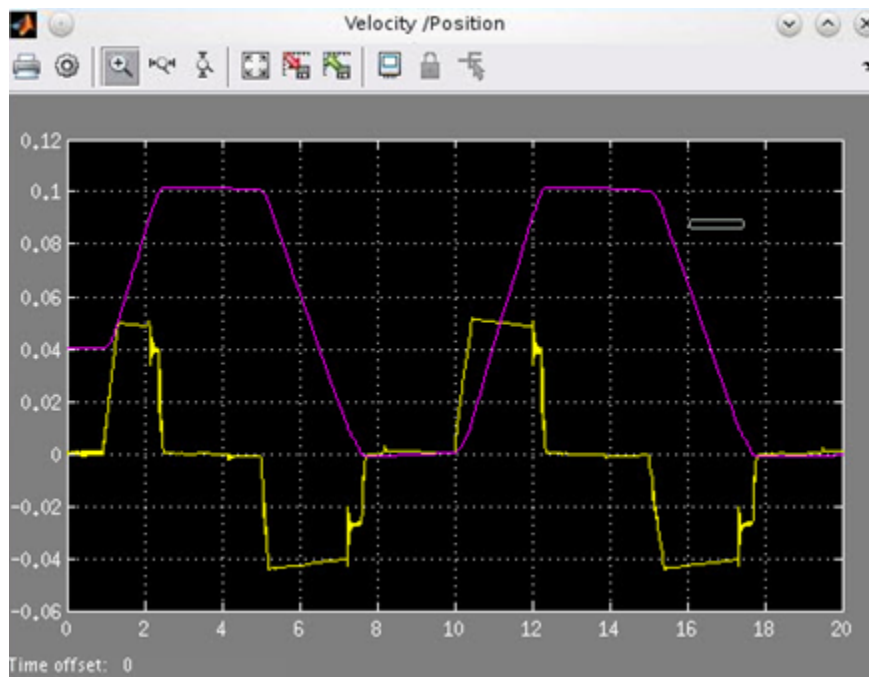

The cushions are set to provide deceleration at ~ 10 mm before the end of the stroke. The stroke of the cylinder is 10 cm, and the initial position of the piston is 0.04 m. The plot shows the velocity (yellow line) and motion (magenta line) profiles.

Connections **A** and **B** are hydraulic conserving ports associated with the device hydraulic inlet and outlet. Connection **R** is a mechanical translational conserving port that connects to the cylinder rod. Connection **C** is a mechanical translational conserving port that connects to the cylinder clamping structure.

Ports

Conserving

A – Cylinder inlet

isothermal liquid

Hydraulic conserving port connected to the cylinder inlet.

B – Cylinder outlet

isothermal liquid

Hydraulic conserving port connected to the cylinder outlet.

R – Rod

isothermal liquid

Mechanical translational conserving port connected to the cylinder rod.

C – Mechanical reference

isothermal liquid

Mechanical translational conserving port connected to the cylinder clamping structure.

Parameters

Cushion piston

Cushion piston area — Cross-sectional area

1e-4 m² (default) | positive scalar

Addition of the cushion to a cylinder converts the respective cylinder into two cylinders, rigidly connected and acting in parallel, with the total effective area equal to the piston area before addition. This parameter sets the area of the cushion piston, which is the face area of the cushion bush.

Piston initial displacement — Piston initial offset from cap A

0 (default) | positive scalar

The distance between the cylinder piston and cap A at the start of simulation. The default value is 0, which corresponds to the fully retracted position of the piston.

Piston orientation — Piston direction of movement

Acts in positive direction (default) | Acts in negative direction

Piston orientation with respect to the globally assigned positive direction. Since the cushion piston is part of the cylinder piston, its orientation must be the same as the orientation of the cylinder piston at the side the cushion is attached to. Similar to a cylinder model, if pressure applied at port A exerts force in the negative direction, set the parameter to Acts in negative direction.

Fixed orifice

Fixed orifice area — Cross-sectional open area

1e-6 m² (default)

The area of the fixed orifice installed between cushion chambers.

Fixed orifice flow discharge coefficient — Discharge coefficient for fixed orifice

0.7 (default) | positive scalar

Semi-empirical coefficient that is used in the computation of flow rate through the fixed orifice.

Fixed orifice critical Reynolds number — Transition Reynolds number for fixed orifices

10 (default) | positive scalar

The maximum Reynolds number for laminar flow through the fixed orifice. The transition from laminar to turbulent regime is supposed to take place when the Reynolds number reaches this value. The value of the parameter depends on the orifice geometrical profile. You can find the recommendations on the parameter value in hydraulic textbooks.

Variable orifice

Tabulated piston displacements — Piston displacement for tabular parameterization of orifice area

[-2, 10, 11, 89, 90, 102] mm (default) |

Vector of input values for piston displacements, specified as a one-dimensional array. The input values vector must be strictly increasing. The values can be nonuniformly spaced. The minimum number of values depends on the interpolation method: you must provide at least two values for linear interpolation, at least three values for smooth interpolation. The **Tabulated piston displacements** values are used together with **Tabulated orifice area** values for one-dimensional table lookup. Due to the nature of the cylinder hard stops, the piston can move below zero and above the stroke value. It is good practice to account for piston deformation and provide piston displacements beyond the ideal stroke range to avoid extrapolation.

Tabulated orifice area — Orifice area for tabular parameterization of orifice area

[.004, .006, 9, 9, 9, 9] cm² (default)

Vector of orifice areas, specified as a one-dimensional array. The vector must be the same size as the piston displacements vector. All the values must be positive.

Variable orifice interpolation method — Tabular interpolation

Linear (default) | Smooth

Select one of the following interpolation methods for approximating the output value when the input value is between two consecutive grid points:

- **Linear** — Select this option to get the best performance.
- **Smooth** — Select this option to produce a continuous curve with continuous first-order derivatives.

For more information on interpolation algorithms, see the PS Lookup Table (1D) block reference page.

Variable orifice extrapolation method — Tabular extrapolation

Linear (default) | Nearest

Select one of the following extrapolation methods for determining the output value when the input value is outside the range specified in the argument list:

- **Linear** — Select this option to produce a curve with continuous first-order derivatives in the extrapolation region and at the boundary with the interpolation region.
- **Nearest** — Select this option to produce an extrapolation that does not go above the highest point in the data or below the lowest point in the data.

For more information on extrapolation algorithms, see the PS Lookup Table (1D) block reference page.

Variable orifice flow discharge coefficient — Discharge coefficient for variable orifices

0.7 (default) | positive scalar

Semi-empirical coefficient that is used in the computation of flow rate through the variable orifice.

Variable orifice critical Reynolds number — Transition Reynolds number for variable orifices

10 (default) | positive scalar

The maximum Reynolds number for laminar flow through the variable orifice. The transition from laminar to turbulent regime is assumed to take place when the Reynolds number reaches this value.

The value of the parameter depends on the orifice geometrical profile. You can find recommendations on the parameter value in hydraulics textbooks.

Variable orifice leakage area – Open area when orifice is in fully closed position

1e-12 m² (default) | positive scalar

The total area of possible leaks in the completely closed orifice. The main purpose of the parameter is to maintain numerical integrity of the circuit by preventing a portion of the system from getting isolated after the valve is completely closed. The parameter value must be greater than 0.

Check valve**Check valve maximum area – Maximum open area**

1e-4 m² (default) | positive scalar

Valve passage maximum cross-sectional area. The default value is 1e-4 m².

Check valve cracking pressure – Threshold operating pressure

0.5e5 Pa (default) | positive scalar

Pressure level at which the orifice of the valve starts to open.

Check valve full opening pressure – Pressure that fully opens the valve

1.5e5 Pa (default)

Pressure differential across the valve needed to fully open the valve. Its value must be higher than the cracking pressure.

Check valve flow discharge coefficient – Discharge coefficient

0.7 (default) | positive scalar

Semi-empirical coefficient that is used in the computation of flow rate through the check valve.

Check valve critical Reynolds number – Transition Reynolds number for check valve flows

10 (default) | positive scalar

The maximum Reynolds number for laminar flow through the check valve. The transition from laminar to turbulent regime is assumed to take place when the Reynolds number reaches this value.

Check valve leakage area – Open area when valve is fully closed

1e-12 m² (default) | positive scalar

The total area of possible leaks in the completely closed valve. The main purpose of the parameter is to maintain numerical integrity of the circuit by preventing a portion of the system from getting isolated after the valve is completely closed. The parameter value must be greater than 0.

References

[1] Rohner, P. *Industrial Hydraulic Control*. Fourth edition. Brisbane : John Wiley & Sons, 1995.

Extended Capabilities

C/C++ Code Generation

Generate C and C++ code using Simulink® Coder™.

See Also

Check Valve | Fixed Orifice | Variable Orifice

Topics

“Upgrading Simscape Fluids Models Containing Hydraulics (Isothermal) Blocks”

Introduced in R2013b

Cylinder Cushion (IL)

Cushion in cylinder in isothermal liquid network

Library: Simscape / Fluids / Isothermal Liquid / Actuators / Auxiliary Components



Description

The Cylinder Cushion (IL) block models a cylinder cushion in an isothermal liquid network. The cushion decelerates the cylinder rod as it approaches the end of a stroke by restricting the flow rate leaving the cylinder chamber. This figure below shows a typical cylinder cushion design [1].

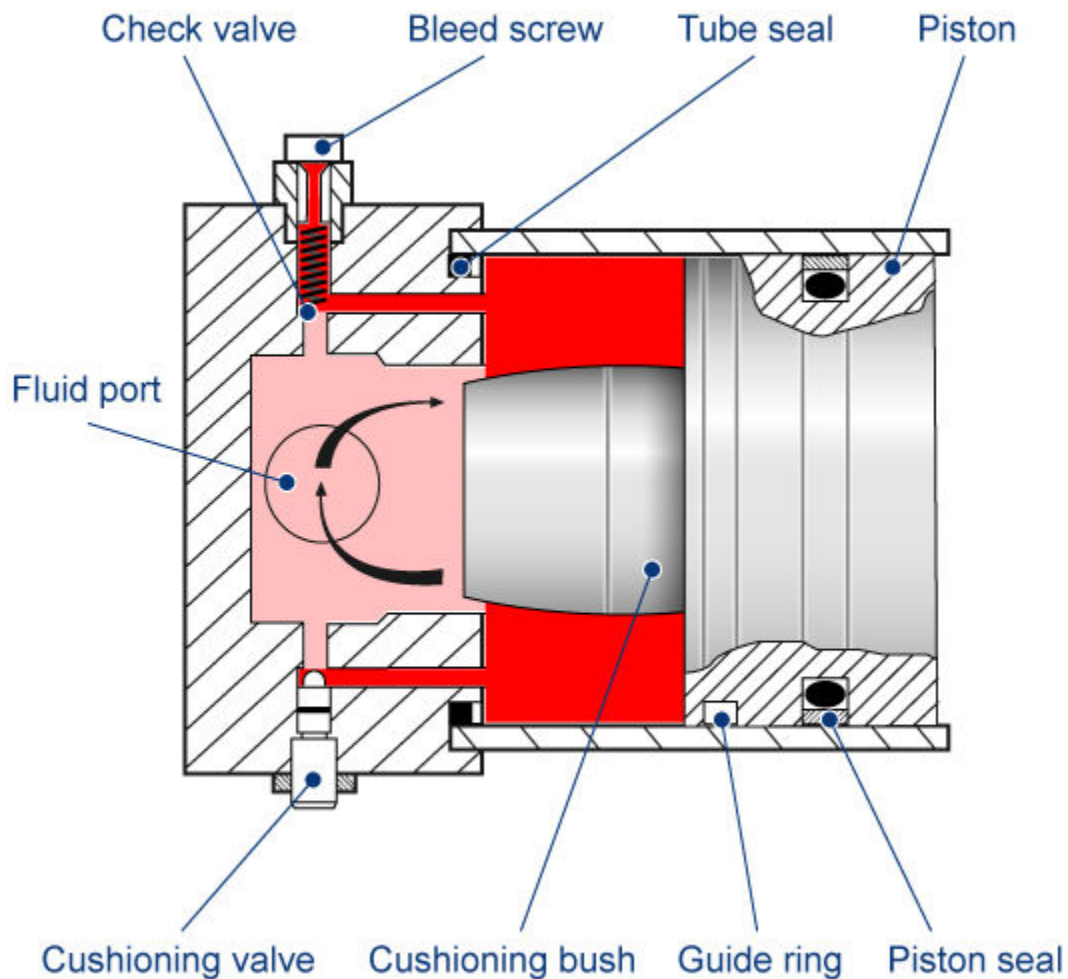

Typical Cylinder Cushion Design

As the piston moves toward the cap (to the left in the figure), the plunger (the cushioning bush) enters the chamber in the cap and creates an additional resistance to the fluid leaving the cylinder chamber. The piston deceleration starts when the plunger enters the opening in the cap and closes the main fluid exit. In this state, the fluid flows through the gap between the cylinder and the cap through a cushioning valve. This restricts the flow rate leaving the cylinder chamber and reduces the initial speed of the piston.

The device contains a check valve between the cylinder and the cap. The check valve eases piston response during retraction by providing a flow path between the cap and cylinder chamber.

The cylinder cushion is a composite of a variable orifice, a fixed orifice, and a check valve. The variable orifice provides a variable opening between the plunger and end cap cavity. The fixed orifice connects the piston chamber to the cushion chamber. The check valve provides a flow path between the cushion chamber and the piston chamber during piston retraction only.

The Cylinder Cushion (IL) block is a composite component that consists of these blocks shown in the figure:

- A Local Restriction (IL) block that models the cushioning valve.
- A Check Valve (IL) block that models the check valve.
- An Orifice (IL) block that models the variable gap between the plunger and the end cap.
- An Ideal Translational Motion Sensor block that converts the separation between the plunger and the cavity in the end cap into a physical signal. This signal controls the opening of the Orifice (IL) block.

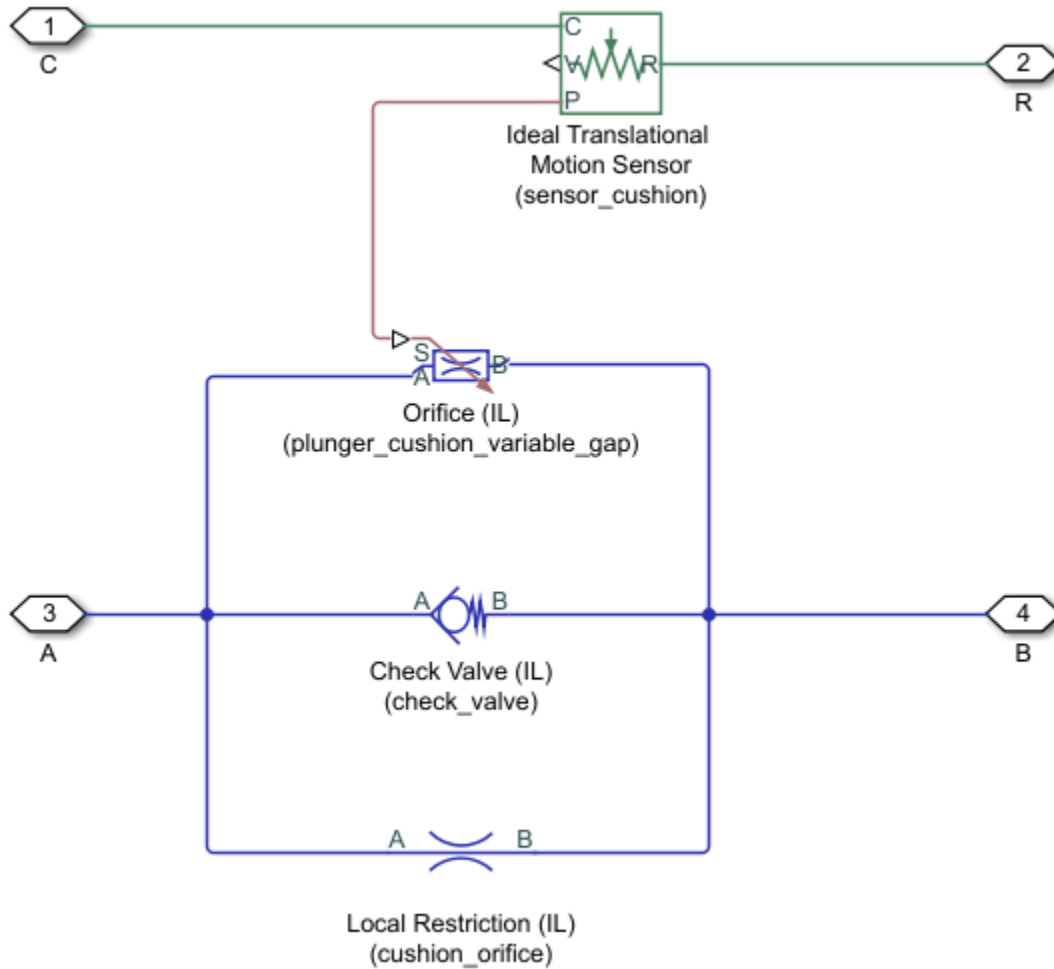

The Cylinder Cushion (IL) block is an actuator building block. A single-acting or double-acting actuator can optionally include cylinder cushions to slow piston motion near the ends of the stroke. This prevents extreme impacts when the piston is stopped by the end caps.

Ports **A** and **B** are isothermal liquid conserving ports associated with the chamber inlet and outlet, respectively. Port **R** is a mechanical translational conserving port connected with the piston plunger. Port **C** is a mechanical translational conserving port that corresponds to the cylinder clamping structure. The block develops a cushioning effect for the flow rate from port **B** to port **A**. The check valve in the block is oriented from port **A** to port **B**.

Equation for Area of Variable Orifice

In the variable orifice, it is assumed that when the plunger is far away from the cushion, the orifice area is fully open and equal to $\pi D_{plunger}^2/4$, where $D_{plunger}$ is the diameter of the circular plunger. Also, when the plunger is in the cushion, the orifice is fully closed and the orifice area is equal to the leakage area. As the plunger moves close to the cushion, the fluid flows radially from the cylinder chamber to the cap chamber through the gap between the plunger and the opening in the cap. Therefore, it can be assumed that the orifice area changes linearly with piston displacement between

the maximum area and the leakage area. The orifice area for a given position of the piston is calculated as:

$$S = \begin{cases} S_{leak}, & \varepsilon x_{piston} \leq L_{plunger} \\ S_{max}, & \varepsilon x_{piston} \geq L_{plunger} + \frac{D_{plunger}}{4} \\ \frac{S_{max} - S_{leak}}{\frac{D_{plunger}}{4}} (\varepsilon x_{piston} - L_{plunger}) + S_{leak}, & L_{plunger} < \varepsilon x_{piston} < L_{plunger} + \frac{D_{plunger}}{4} \end{cases}$$

where:

- S is the orifice area for a given position of the piston.
- S_{leak} is the **Leakage area**.
- $S_{plunger}$ is the **Cushion plunger cross-sectional area**.
- S_{max} is the **Maximum orifice area**. It is equal to $S_{plunger}$.
- x_{piston} is the displacement of the piston. (You must provide the initial displacement of the piston $x_{0,piston}$ as a block parameter.)
- ε is the **Actuator mechanical orientation** of the cylinder cushion (1 if the displacement indicates positive motion, -1 if the displacement moves in the negative direction).
- $L_{plunger}$ is the **Cushion plunger length**.
- $D_{plunger}$ is the **Cushion plunger diameter**.

Numerically-Smoothed Area and Pressure

At the extremes of the orifice area and check valve pressure range, you can maintain numerical robustness in your simulation by adjusting the block **Smoothing factor**. A smoothing function is applied to all calculated areas and valve pressures, but primarily influences the simulation at the extremes of these ranges.

The normalized orifice area is calculated as:

$$\widehat{S} = \frac{(S - S_{leak})}{(S_{max} - S_{leak})}.$$

The **Smoothing factor**, f , is applied to the normalized area:

$$\widehat{S}_{smoothed} = \frac{1}{2} + \frac{1}{2} \sqrt{\widehat{S}^2 + \left(\frac{f}{4}\right)^2} - \frac{1}{2} \sqrt{(\widehat{S} - 1)^2 + \left(\frac{f}{4}\right)^2}.$$

The smoothed orifice area is:

$$S_{smoothed} = \widehat{S}_{smoothed}(S_{max} - S_{leak}) + S_{leak}.$$

Similarly, the normalized valve pressure is:

$$\widehat{p} = \frac{(p - p_{cracking})}{(p_{max} - p_{cracking})}.$$

where:

- $p_{cracking}$ is the **Check valve cracking pressure differential**.
- p_{max} is the **Check valve maximum pressure differential**.

Smoothing applied to the normalized pressure is:

$$\widehat{p}_{smoothed} = \frac{1}{2} + \frac{1}{2}\sqrt{\widehat{p}^2 + \left(\frac{f}{4}\right)^2} - \frac{1}{2}\sqrt{(\widehat{p} - 1)^2 + \left(\frac{f}{4}\right)^2},$$

and the smoothed pressure is:

$$p_{smoothed} = \widehat{p}_{smoothed}(p_{max} - p_{cracking}) + p_{cracking}.$$

Ports

Conserving

A — Liquid port

isothermal liquid

Entry port of the liquid to the cushion chamber.

B — Liquid port

isothermal liquid

Exit port of the liquid from the cushion chamber

R — Rod

mechanical translational

Mechanical translational conserving port connected with the piston plunger velocity and force.

C — Case

mechanical translational

Mechanical translational conserving port connected to the cylinder reference structure.

Parameters

Cushion Plunger

Cushion plunger cross-sectional area — Cross-sectional area of cushion plunger

1e-4 m² (default) | positive scalar

Area of the cross-section of the cushion plunger, which is assumed to be circular. The area is equal to $\pi D_{plunger}^2/4$, where $D_{plunger}$ is the diameter of the circular plunger.

Cushion plunger length — Length of cushion plunger

1e-3 m (default) | positive scalar

Length of the cushion plunger.

Actuator piston initial displacement — Initial displacement of attached piston

0 m (default) | scalar

Displacement of the piston in the cylinder at the start of simulation. This displacement determines the initial area of the variable orifice that models the variable gap between the plunger and the end cap.

Dependencies

If the **Actuator mechanical orientation** block parameter is set to Pressure at A causes positive displacement of R relative to C, the value of the piston initial displacement must be positive or zero.

If the **Actuator mechanical orientation** block parameter is set to Pressure at A causes negative displacement of R relative to C, the value of the piston initial displacement must be negative or zero.

Actuator mechanical orientation – Piston displacement direction

Pressure at A causes positive displacement of R relative to C (default) | Pressure at A causes negative displacement of R relative to C

Piston displacement direction of the connected actuator block. If this parameter is set to Pressure at A causes positive displacement of R relative to C, the piston extends when **R - C** is positive. If this parameter is set to Pressure at A causes negative displacement of R relative to C, the piston retracts when **R - C** is positive.

Valves

Cushion orifice area – Orifice area of cushioning valve

1e-6 m² (default) | positive scalar

Constant orifice area of the valve through which the fluid flows from the cylinder chamber to the cap chamber when the plunger is inside the opening in the cap.

Leakage area between plunger and cushion sleeve – Total leakage area when the plunger is inside the cap opening

1e-7 m² (default) | positive scalar

Total area of possible leaks when the plunger is inside the cap opening (the cushion sleeve). The area of the variable orifice modeling gap between the plunger and the cushion sleeve is equal to this leakage area when the displacement of the piston is less than or equal to the **Cushion plunger length** parameter.

Check valve cracking pressure differential – Pressure differential at which the check valve starts to open

0.01 MPa (default) | positive scalar

Minimum pressure differential across the check valve at which the valve starts to open. The check valve allows free flow of the liquid from the cushion chamber to the piston chamber but does not allow flow in the opposite direction.

Check valve maximum pressure differential – Pressure differential needed to fully open the check valve

0.1 MPa (default) | positive scalar

Pressure differential across the check valve needed to fully open the valve. The value of this parameter must be greater than the **Check valve cracking pressure differential** parameter. The

check valve allows free flow of the liquid from the cushion chamber to the piston chamber but does not allow flow in the opposite direction.

Check valve maximum area — Opening area when check valve is fully open

1e-4 m² (default) | positive scalar

Passage area of the check valve when the valve is fully open.

Check valve leakage area — Total leakage area when check valve is fully closed

1e-10 m² (default) | positive scalar

Total area of possible leaks when the check valve is fully closed.

Smoothing factor — Amount of smoothing to apply to check valve and variable orifice opening area functions

0.01 (default) | positive scalar

Continuous smoothing factor that introduces a layer of gradual change to the flow response when the valve is in near-open or near-closed positions. Set this value to a nonzero value less than one to increase the stability of your simulation in these regimes.

References

[1] Rohner, P. *Industrial Hydraulic Control*. Fourth edition. Brisbane: John Wiley & Sons, 1995.

See Also

Single-Acting Actuator (IL) | Double-Acting Actuator (IL) | Cylinder Friction (IL)

Introduced in R2020a

Cylinder Friction

Friction in hydraulic cylinders



Library

Hydraulic Cylinders

Description

The Cylinder Friction block simulates friction in the contact between moving bodies in hydraulic cylinders and is intended to be used primarily as a building block in combination with both the double- and single-acting cylinders to develop a cylinder model with friction. The friction force is simulated as a function of relative velocity and pressure, and is assumed to be the sum of Stribeck, Coulomb, and viscous components. The Coulomb friction force consists of the preload force, caused by the seal squeeze during assembly, and the force proportional to pressure. The sum of the Coulomb and Stribeck friction forces at zero velocity is often referred to as the breakaway friction force. For more information, see the Translational Friction block reference page.

The friction force is approximated with the following equations:

$$F = F_C \cdot (1 + (K_{brk} - 1) \cdot \exp(-c_v |v|)) \text{sign}(v) + f_{vfr} \cdot v$$

$$F_C = F_{pr} + f_{cfr}(p_A + p_B)$$

where

F	Friction force
F_C	Coulomb friction
F_{pr}	Preload force
f_{cfr}	Coulomb friction coefficient
p_A, p_B	Pressures in cylinder chambers
K_{brk}	Breakaway friction force increase coefficient
c_v	Transition coefficient
v	Relative velocity in the contact
f_{vfr}	Viscous friction coefficient

To avoid discontinuity at $v = 0$, a small region $|v| \leq v_{th}$ is introduced around zero velocity, where friction force is assumed to be linearly proportional to velocity:

$$F = K \cdot v$$

$$K = \frac{F_C(1 + (K_{brk} - 1) \cdot \exp(-c_v v_{th})) + f_{vfr} \cdot v_{th}}{v_{th}}$$

where

K	Proportionality coefficient
v _{th}	Velocity threshold

Connections R and C are mechanical translational conserving ports associated with the rod and case, respectively. Connections A and B are hydraulic conserving ports to be connected to ports A and B of the cylinder model, as shown in the following illustration. The force generated by the block always opposes relative motion between the rod and the case.

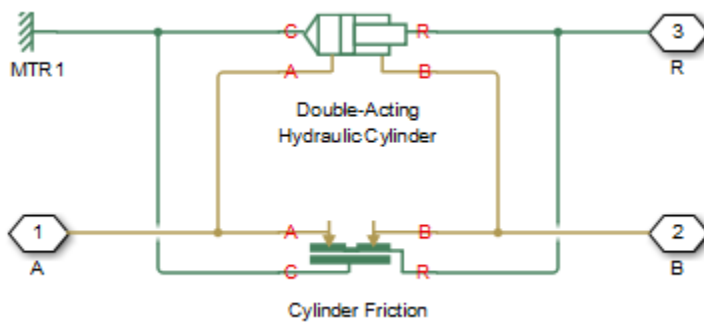

Parameters

- “Parameters Tab” on page 1-566
- “Variables Tab” on page 1-567

Parameters Tab

Preload force

The preload force, caused by the seal squeeze during assembly. The default value is 10 N.

Coulomb friction force coefficient

Coulomb friction coefficient, which defines the proportionality between the Coulomb friction force and the pressure in cylinder chambers. The default value is 1e-6 N/Pa.

Breakaway friction increase coefficient

The friction force increase over the Coulomb friction. The Coulomb friction force, multiplied by this coefficient, is referred to as breakaway friction force. The default value is 1.

Viscous friction coefficient

Proportionality coefficient between the viscous friction force and the relative velocity. The parameter value must be greater than or equal to zero. The default value is 100 N/(m/s).

Transition approximation coefficient

The parameter sets the value of coefficient c_v , which is used for the approximation of the transition between the breakaway and the Coulomb frictions. Its value is assigned based on the following considerations: the Stribeck friction component reaches approximately 5% of its steady-state value at velocity $3/c_v$, and 2% at velocity $4/c_v$, which makes it possible to develop an

approximate relationship $c_v \sim 4/v_{\min}$, where v_{\min} is the relative velocity at which friction force has its minimum value. By default, c_v is set to 10 s/m, which corresponds to a minimum friction at velocity of about 0.4 m/s.

Linear region velocity threshold

The parameter sets the small vicinity near zero velocity, within which friction force is considered to be linearly proportional to the relative velocity. MathWorks recommends that you use values in the range between 1e-6 and 1e-4 m/s. The default value is 1e-4 m/s.

Variables Tab

Use the **Variables** tab to set the priority and initial target values for the block variables prior to simulation. For more information, see “Set Priority and Initial Target for Block Variables”.

Ports

The block has the following ports:

- A
Hydraulic conserving port connected to the cylinder inlet.
- B
Hydraulic conserving port connected to the cylinder outlet.
- R
Mechanical translational conserving port associated with the cylinder rod.
- C
Mechanical translational conserving port associated with the cylinder clamping structure.

Extended Capabilities

C/C++ Code Generation

Generate C and C++ code using Simulink® Coder™.

See Also

Double-Acting Hydraulic Cylinder | Single-Acting Hydraulic Cylinder

Topics

“Upgrading Simscape Fluids Models Containing Hydraulics (Isothermal) Blocks”

Introduced in R2006b

Cylinder Friction (IL)

Adds friction to cylinders with moving components

Library: Simscape / Fluids / Isothermal Liquid / Actuators / Auxiliary Components



Description

The Cylinder Friction (IL) block models friction on a moving cylinder. The total friction is a combination of Stribeck, Coulomb, and viscous effects. The Coulomb friction component includes any initial force applied by the seal and the influence of pressure in the cylinder.

The Stribeck and viscous forces are calculated in the same way as for the Simscape Foundational Library Translational Friction block.

The Stribeck Friction and Viscous Friction Forces

The Stribeck friction force is the dominating friction component at low velocities. It is calculated as:

$$F_{\text{Stribeck}} = \sqrt{2}e^{(R_{\text{break,Coulomb}} - 1)} \cdot F_C \left(\frac{v}{v_{\text{static,th}}} \right) e^{-\left(\frac{v}{v_{\text{static,th}}} \right)^2},$$

where:

- $R_{\text{break,Coulomb}}$ is the ratio of the breakaway force to the Coulomb force: $R_{\text{break,Coulomb}} = \frac{F_{\text{break}}}{F_{\text{Coulomb}}}$.
- v is the velocity of the cylinder, $v = v_R - v_C$.
- $v_{\text{static,th}}$ is the threshold velocity for static torque:

$$v_{\text{static,th}} = \sqrt{2}v_{\text{break}},$$

where v_{break} is the **Breakaway friction velocity**. A transition range is established between 0 and the threshold velocity for static torque to ensure smooth modeling of the friction force.

- F_C is introduced in “The Coulomb Friction Force” on page 1-568 section below.

The viscous friction force is based on the **Viscous friction coefficient** of the working fluid, f_{viscous} , and is proportional to the cylinder velocity:

$$F_{\text{viscous}} = f_{\text{viscous}}v.$$

The Coulomb Friction Force

The Coulomb friction force is a force that acts normal to the friction surface. The cylinder motion creates a radial stress inside the fixed cylinder casing, which increases as the cylinder compresses the internal fluid. The radial stress is normal to the cylinder motion, and results in a Coulomb friction force that opposes cylinder motion.

The Coulomb frictional force is calculated as:

$$F_{Coulomb} = F_c \tanh\left(\frac{v}{v_{Coulomb,th}}\right),$$

where v is the relative velocity between ports **R** and **C** ($v_R - v_C$), and $v_{Coulomb,th}$ is the threshold velocity for Coulomb force:

$$v_{Coulomb,th} = \frac{v_{break}}{10}.$$

Note that the threshold velocity for Coulomb force is a different quantity than the threshold velocity for the static force, which is used to calculate the Stribeck friction force, although they both act as a threshold region to ensure smooth modeling of the Coulomb and Stribeck forces.

F_C is the force contribution from seal preloading (the **Preload force**) and the pressure in the cylinder:

$$F_C = F_{preload} + f_{Coulomb}(P_A + P_B),$$

where $f_{Coulomb}$ is the **Coulomb friction force coefficient**. P_A and P_B , the pressures at cylinder ports **A** and **B**, are gauge pressures with respect to the environmental pressure, specified either as atmospheric or another user-defined value in the **Environment pressure specification** parameter.

Ports

Conserving

A – Liquid port

isothermal liquid

Liquid entry or exit point to the orifice.

B – Liquid port

isothermal liquid

Liquid entry or exit point to the orifice.

C – Mechanical port velocity, m/s

mechanical translational

Mechanical port for cylinder housing motion, in m/s.

R – Mechanical port velocity, m/s

mechanical translational

Mechanical port for cylinder rod motion, in m/s.

Parameters

Breakaway to Coulomb friction force ratio – Ratio of breakaway force to Coulomb friction force

1.2 (default) | positive scalar

Ratio of the breakaway force to the Coulomb friction force.

Breakaway friction velocity – Threshold for motion against friction force

0.1 m/s (default) | positive scalar

Threshold for movement against friction force.

Preload force – Initial force in cylinder due to seal assembly

20 N (default) | scalar

Initial force in the cylinder due to seal assembly.

Coulomb friction force coefficient – Coulomb friction force coefficient

1e-6 N/Pa (default) | positive scalar

Coulomb friction force coefficient.

Viscous friction coefficient – Viscous friction coefficient

100 N/(m/s) (default) | positive scalar

Viscous friction coefficient. This parameter is used to calculate the viscous friction force.

Environment pressure specification – Pressure reference source

Atmospheric pressure (default) | Specified pressure

Identifies pressure reference for the Coulomb friction calculation.

Environment pressure – User-defined pressure reference

0.101325 MPa (default) | positive scalar

User-defined pressure reference for the Coulomb friction calculation.

Dependencies

To enable this parameter, set **Environment pressure specification** to Specified pressure.

See Also

Cylinder Cushion (IL) | Single-Acting Actuator (IL) | Pilot Valve Actuator (IL) | Double-Acting Actuator (IL)

Introduced in R2020a

Hydraulic Double-Acting Valve Actuator

Double-acting hydraulic valve actuator



Library

Valve Actuators

Description

Use the Hydraulic Double-Acting Valve Actuator block as a pilot actuator for directional, pressure, or flow control valves in applications where all the forces, except spring force, and flow consumption can be neglected. The actuator consists of two single-acting actuators acting against each other. Each single-acting actuator consists of a piston, centering spring, and centering washer. When control pressure is applied to either hydraulic port, only one centering spring is compressed by its washer while the other butts against the valve body and exerts no force on the spool. When both control pressures are released, the springs force the washers against the valve body, and the spool centers between them. This design allows each actuator to have a different spring, preload force, and piston area.

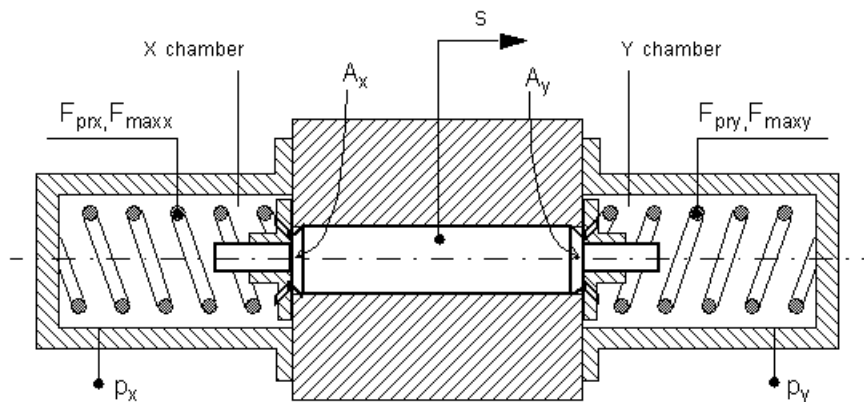

As pressure applied to the piston develops enough force to overcome the spring preload, the piston moves to the opposite position until it reaches its maximum stroke. Pressure applied at port X shifts the valve in the x -direction, overcoming the spring located in the Y chamber. Pressure applied at port Y shifts the valve in the y -direction, overcoming the spring located in the X chamber.

The actuator is simulated according to the following equations:

$$F = p_x \cdot A_x - p_y \cdot A_y$$

$$L_x = \frac{str_x}{F_{maxx} - F_{prx}}$$

$$L_y = \frac{str_y}{F_{maxy} - F_{pry}}$$

If $F \geq 0$,

$$s = \begin{cases} 0 & \text{for } F \leq F_{pry} \\ L_y \cdot (F - F_{pry}) \cdot or & \text{for } F_{pry} < F < F_{maxy} \\ str_y \cdot or & \text{for } F \geq F_{maxy} \end{cases}$$

If $F < 0$,

$$s = \begin{cases} 0 & \text{for } |F| \leq F_{prx} \\ -L_x \cdot (|F| - F_{prx}) \cdot or & \text{for } F_{prx} < |F| < F_{maxx} \\ -str_x \cdot or & \text{for } |F| \geq F_{maxx} \end{cases}$$

where

F	Force acting on the valve
s	Piston displacement
p_x	Pressure in the actuator X chamber
p_y	Pressure in the actuator Y chamber
A_x	Valve face area in the X chamber
A_y	Valve face area in the Y chamber
str_x	Valve stroke in x-direction
str_y	Valve stroke in y-direction
F_{prx}	Chamber X spring preload force
F_{maxx}	Chamber X spring maximum force
F_{pry}	Chamber Y spring preload force
F_{maxy}	Chamber Y spring maximum force
or	Actuator orientation with respect to the globally assigned positive direction. If pressure applied at port X moves the piston in positive direction, or equals 1. If pressure applied at port X moves the piston in negative direction, or equals -1.

Connections X and Y are hydraulic conserving ports associated with the valve chambers. Connection P is a physical signal port whose output corresponds to piston displacement. Pressure applied at port X moves the piston in the positive or negative direction depending on the value of the **Actuator orientation** parameter.

Basic Assumptions and Limitations

- The flow consumption associated with the valve motion is assumed to be negligible.
- The inertia, friction, and hydraulic axial forces are assumed to be small and are not taken into account.
- The clearances between the valve and the washers are not taken into account.

Parameters

Piston area at port X

Effective piston area at port X. The parameter value must be greater than zero. The default value is $2e-4 \text{ m}^2$.

Piston area at port Y

Effective piston area at port Y. The parameter value must be greater than zero. The default value is $2e-4 \text{ m}^2$.

Preload force at port X

Spring preload force at port X. The default value is 0.

Preload force at port Y

Spring preload force at port Y. The default value is 0.

Spring maximum force at port X

Chamber X spring maximum force. The parameter value must be greater than the spring preload force. The default value is 50 N.

Spring maximum force at port Y

Chamber Y spring maximum force. The parameter value must be greater than the spring preload force. The default value is 50 N.

Piston stroke at port X

Piston stroke in chamber X. The parameter value must be greater than or equal to zero. The default value is $5e-3 \text{ m}$.

Piston stroke at port Y

Piston stroke in chamber Y. The parameter value must be greater than or equal to zero. The default value is $5e-3 \text{ m}$.

Actuator orientation

Specifies actuator orientation with respect to the globally assigned positive direction. The actuator can be installed in two different ways, depending upon whether it moves the piston in the positive or in the negative direction when pressure is applied at its inlet. If pressure applied at port X moves the piston in the negative direction, set the parameter to `Acts in negative direction`. The default value is `Acts in positive direction`.

Restricted Parameters

When your model is in Restricted editing mode, you cannot modify the following parameter:

- **Actuator orientation**

All other block parameters are available for modification.

Ports

The block has the following ports:

X

Hydraulic conserving port associated with the valve X chamber.

Y

Hydraulic conserving port associated with the valve Y chamber.

P

Physical signal port that outputs piston displacement.

Examples

The following illustration shows a typical control unit of a variable-displacement pump that provides load sensing and pressure limiting (see [1] on page 1-575). In the unit, the load-sensing compensator varies the pump displacement to maintain a preset pressure differential across the variable orifice, while the pressure-limiting compensator does not allow the pump pressure to exceed the pressure limit.

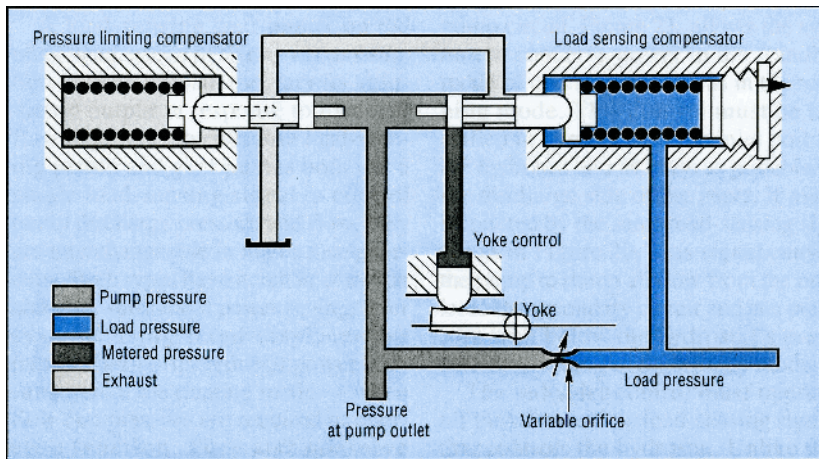

The “Hydraulic Motor Driven by Load-Sensing Variable-Displacement Pump” example implements this type of control. The next illustration shows the schematic of the Control block in the example model.

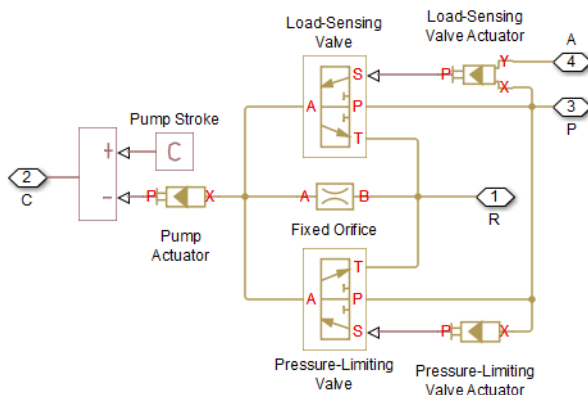

There are three hydraulic valve actuators in the model:

- Pressure-Limiting Valve Actuator — A single-acting actuator that controls the Pressure-Limiting Valve.
- Pump Actuator — A single-acting valve actuator that acts on the pump displacement control device (yoke control).

- Load-Sensing Valve Actuator — A double-acting valve actuator that controls the Load-Sensing Valve. Its output is proportional to the difference between the pump pressure (port P) and the load pressure (port A).

Open the example model to see the parameter settings for the blocks.

References

[1] F. Yeapple, *Fluid Power Design Handbook*, Marcel Dekker, Inc., 1995

Extended Capabilities

C/C++ Code Generation

Generate C and C++ code using Simulink® Coder™.

See Also

2-Position Valve Actuator | 3-Position Valve Actuator | Hydraulic Single-Acting Valve Actuator | Proportional and Servo-Valve Actuator

Introduced in R2007a

Double-Acting Actuator (IL)

Linear conversion of pressure differential to actuation in an isothermal liquid system

Library: Simscape / Fluids / Isothermal Liquid / Actuators



Description

The Double-Acting Actuator (IL) block models the linear conversion of a pressure differential between two chambers to piston motion. The piston actuation is controlled by the pressure differential acting on the piston plate that separates the chambers. The motion of the piston when it is near full extension or full retraction is limited by one of three hard stop models. Fluid compressibility is optionally modeled in both piston chambers.

Ports **A** and **B** are isothermal liquid inlets. Port **C** represents the actuator casing, while piston velocity is returned at port **R**. When the piston position is calculated internally, it is reported at port **p**, and when the position is set by a connection to a Simscape Multibody™ joint, it is received as a physical signal at port **p**.

You can define the piston displacement direction with the **Mechanical orientation** parameter. If the mechanical orientation is set to **Pressure at A causes positive displacement of R relative to C**, the piston extends when the pressure differential $p_A - p_B$ is positive. If **Mechanical orientation** is set to **Pressure at A causes negative displacement of R relative to C**, the piston retracts for a positive pressure difference between the liquid and gas chambers.

Displacement

The piston displacement is measured as the position at port **R** relative to port **C**. The **Mechanical orientation** identifies the direction of piston displacement. The piston displacement is neutral, or θ , when the chamber A volume is equal to the chamber dead volume. When displacement is received as an input, ensure that the derivative of the position is equal to the piston velocity. This is automatically the case when the input is received from a Translational Multibody Interface block connection to a Simscape Multibody joint.

Hard Stop Model

To avoid mechanical damage to an actuator when it is fully extended or fully retracted, an actuator typically displays nonlinear behavior when the piston approaches these limits. The Double-Acting Actuator (IL) block models this behavior with a choice of three hard stop models, which model the material compliance through a spring-damper system. The hard stop models are:

- Stiffness and damping applied smoothly through transition region, damped rebound.
- Full stiffness and damping applied at bounds, undamped rebound.
- Full stiffness and damping applied at bounds, damped rebound.

The hard stop force is modeled when the piston is at its upper or lower bound. The boundary region is within the **Transition region** of the **Piston stroke** or piston initial displacement. Outside of this region, $F_{HardStop} = 0$.

For more information about these settings, see the Translational Hard Stop block page.

Cushion

You can optionally model cushioning toward the extremes of the piston stroke. Modeling cylinder end cushioning slows the piston motion as it approaches its maximum extension within its respective chamber, which is defined in **Piston stroke**. For more information on the functionality of a cylinder cushion, see Cylinder Cushion (IL).

Friction

You can optionally model friction against piston motion. When **Cylinder friction effect** is set to On, the resulting friction is a combination of Stribeck, Coulomb, and viscous effects. The pressure difference is measured between the chamber pressure and the environment pressure. For more information on the friction model and its limitations, see the Cylinder Friction block.

Leakage

You can optionally model leakage between the liquid chambers and the piston reservoir. When **Internal leakage** is set to On, Poiseuille flow is modeled between the piston and cylinder. This block uses the Simscape Foundation Library Laminar Leakage (IL) block. The flow rate is calculated as:

$$\dot{m} = \frac{\frac{\pi}{128} \left(d_0^4 - d_i^4 - \frac{(d_0^2 - d_i^2)^2}{\log(d_0/d_i)} \right)}{\nu L} (p_A - p_{env}),$$

where:

- ν is the fluid kinematic viscosity.
- L is the piston length, $\mathbf{p} - P_0$.
- p_A is the pressure at port **A**.
- p_{env} is the environmental pressure, which is selected in the **Environment pressure specification** parameter.

The cylinder diameter, d_0 , is $d_0 = d_i + 2c$, where c is the **Piston-cylinder clearance**, and the piston diameter, d_i , is $d_i = \sqrt{\frac{4A_p}{\pi}}$, where A_p is the average of the **Piston cross-sectional area in chamber A** and **Piston cross-sectional area in chamber B** parameters.

Numerically-Smoothed Area and Pressure

At the extremes of the cushion A and B orifice areas and check valve pressure ranges, you can maintain numerical robustness in your simulation by adjusting the block **Smoothing factor**. A smoothing function is applied to all calculated areas and valve pressures, but primarily influences the simulation at the extremes of these ranges.

The normalized orifice area is calculated as:

$$\hat{A} = \frac{(A - A_{leak})}{(A_{max} - A_{leak})}.$$

where:

- A_{leak} is the cushion A and cushion B **Leakage area between plunger and cushion sleeve.**
- A_{max} is the cushion A and cushion B **Cushion plunger cross-sectional area.**

The **Smoothing factor**, f , is applied to the normalized area:

$$\widehat{A}_{smoothed} = \frac{1}{2} + \frac{1}{2}\sqrt{\widehat{A}^2 + \left(\frac{f}{4}\right)^2} - \frac{1}{2}\sqrt{(\widehat{A} - 1)^2 + \left(\frac{f}{4}\right)^2}.$$

The smoothed orifice area is:

$$A_{smoothed} = \widehat{A}_{smoothed}(A_{max} - A_{leak}) + A_{leak}.$$

Similarly, the normalized valve pressure is:

$$\widehat{p} = \frac{(p - p_{cracking})}{(p_{max} - p_{cracking})}.$$

where:

- $p_{cracking}$ is the cushion **Check valve cracking pressure differential.**
- p_{max} is the cushion **Check valve maximum pressure differential.**

Smoothing applied to the normalized pressure is:

$$\widehat{p}_{smoothed} = \frac{1}{2} + \frac{1}{2}\sqrt{\widehat{p}^2 + \left(\frac{f}{4}\right)^2} - \frac{1}{2}\sqrt{(\widehat{p} - 1)^2 + \left(\frac{f}{4}\right)^2},$$

and the smoothed pressure is:

$$p_{smoothed} = \widehat{p}_{smoothed}(p_{max} - p_{cracking}) + p_{cracking}.$$

Block Schematic

The Double-Acting Actuator (IL) block comprises four Simscape Foundation blocks:

- Laminar Leakage (IL)
- Translational Mechanical Converter (IL)
- Translational Hard Stop
- Ideal Translational Motion Sensor

and two Isothermal Liquid library blocks:

- Cylinder Cushion (IL)
- Cylinder Friction (IL)

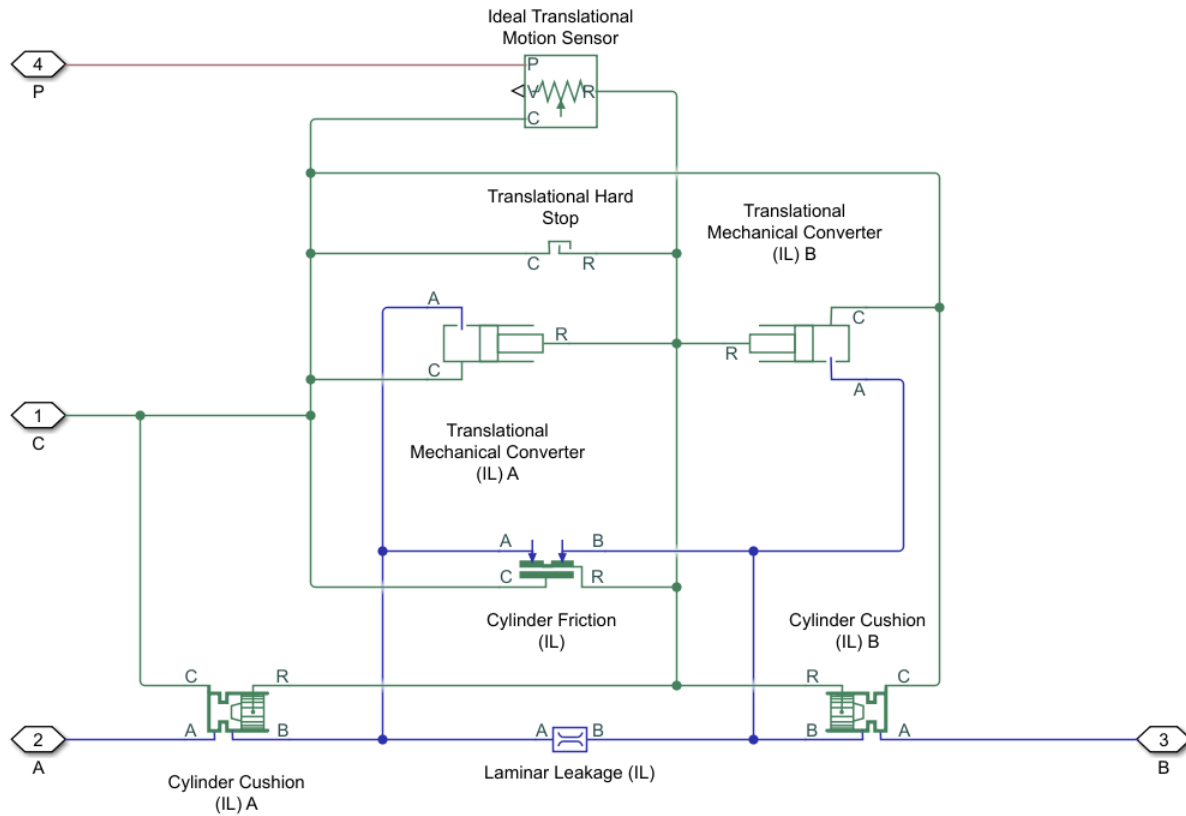

Ports

Conserving

A – Liquid chamber inlet port

isothermal liquid

Inlet port to liquid chamber A.

B – Liquid chamber inlet port

isothermal liquid

Inlet port to liquid chamber B.

C – Actuator casing

mechanical translational

Actuator casing reference velocity and force.

R – Actuator shaft

mechanical translational

Port associated with the piston velocity and force.

Input

p — Piston position, m

physical signal

Piston position in m, received as a physical signal from a Simscape Multibody block.

Dependencies

To expose this port, set **Piston displacement from chamber A cap** to Provide input signal from Multibody joint.

Output

p — Piston position, m

physical signal

Piston position in m, returned as a physical signal.

Dependencies

To expose this port, set **Piston displacement from chamber A cap** to Calculate from velocity of port R relative to port C.

Parameters

Actuator

Mechanical orientation — Piston displacement direction

Pressure at A causes positive displacement of R relative to C (default) | Pressure at A causes negative displacement of R relative to C

Sets the piston displacement direction. When you set this parameter to:

- Pressure at A causes positive displacement of R relative to C the piston displacement is positive when the volume of liquid at port **A** is expanding. This corresponds to rod extension.
- Pressure at A causes negative displacement of R relative to C the piston displacement is negative when the volume of liquid at port **A** is expanding. This corresponds to rod contraction.

Piston cross-sectional area in chamber A — Chamber A piston area

0.01 m² (default) | positive scalar

Cross-sectional area of the piston rod on the chamber A side.

Piston cross-sectional area in chamber B — Chamber B piston area

0.01 m² (default) | positive scalar

Cross-sectional area of the piston rod on the chamber B side.

Piston stroke — Maximum piston travel distance

0.1 m (default) | positive scalar

Maximum piston travel distance.

Dead volume in chamber A — Chamber A fluid volume at full piston retraction1e-5 m³ (default) | positive scalar

Volume of liquid when the piston displacement is 0 in chamber A. This is the liquid volume when the piston is up against the actuator end cap.

Dead volume in chamber B — Chamber B fluid volume at full piston retraction1e-5 m³ (default) | positive scalar

Volume of liquid when the piston displacement is 0 in chamber B. This is the liquid volume when the piston is up against the actuator end cap.

Environment pressure specification — Reference environment pressure

Atmospheric pressure (default) | Specified pressure

Environment reference pressure. The Atmospheric pressure option sets the environmental pressure to 0.101325 MPa.

Environment pressure — User-defined environmental pressure

0.101325 MPa (default) | positive scalar

User-defined environmental pressure.

Dependencies

To enable this parameter, set **Environment pressure specification** to Specified pressure.

Breakaway to Coulomb friction force ratio — Ratio of breakaway force to Coulomb friction force

1.2 (default) | positive scalar

Ratio of the breakaway force to the Coulomb friction force.

Dependencies

To enable this parameter, in the **Friction** tab, set **Cylinder friction effect** to On.

Breakaway friction velocity — Threshold for motion

0.1 m/s (default) | positive scalar

Threshold velocity for motion against friction force to begin.

Dependencies

To enable this parameter, in the **Friction** tab, set **Cylinder friction effect** to On.

Hard Stop**Hard stop stiffness coefficient — Stiffness coefficient**

1e10 N/m (default) | positive scalar

Piston stiffness coefficient. This value must be greater than 0.

Hard stop damping coefficient — Damping coefficient

150 N/(m/s) (default) | positive scalar

Piston damping coefficient.

Hard stop model – Model choice for force on piston at full extension or retraction

Stiffness and damping applied smoothly through transition region, damped rebound (default) | Full stiffness and damping applied at bounds, undamped rebound | Full stiffness and damping applied at bounds, damped rebound

Model choice for the force on the piston at full extension or full retraction. See the Translational Hard Stop block for more information.

Transition region – Application range of hard stop force model

0.1 mm (default) | positive scalar

Application range of the hard stop force model. Outside of this range of the piston maximum extension and piston maximum retraction, the **Hard stop model** is not applied and there is no additional force on the piston.

Dependencies

To enable this parameter, set **Hard stop model** to Stiffness and damping applied smoothly through transition region, damped rebound.

Converter Cushion A**Cylinder A end cushioning – Whether to model piston slow-down at maximum extension**

Off (default) | On

Whether to model piston slow-down at maximum extension. See the Cylinder Cushion (IL) block for more information.

Cushion plunger cross-sectional area – Cylinder cushion plunger area

1e-4 m² (default) | positive scalar

Area of the plunger inside the actuator cushion element.

Dependencies

To enable this parameter, set **Cylinder A end cushioning** to On.

Cushion plunger length – Length of cushion plunger

1e-3 m (default) | positive scalar

Length of the cushion plunger.

Dependencies

To enable this parameter, set **Cylinder A end cushioning** to On.

Cushion orifice area – Area of orifice between cushion chambers

1e-6 m² (default) | positive scalar

Area of the orifice between cushion chambers.

Dependencies

To enable this parameter, set **Cylinder A end cushioning** to On.

Leakage area between plunger and cushion sleeve – Gap between cushion plunger and sleeve1e-7 m² (default) | positive scalar

Gap area between the cushion plunger and sleeve. This value contributes to numerical stability by maintaining continuity in the flow.

Dependencies

To enable this parameter, set **Cylinder A end cushioning** to On.

Check valve cracking pressure differential – Cushion threshold pressure

0.01 MPa (default) | positive scalar

Pressure beyond which the valve operation is triggered. When the pressure difference between port **A** and P_{env} meets or exceeds the **Check valve cracking pressure differential**, the cushion valve begins to open.

Dependencies

To enable this parameter, set **Cylinder A end cushioning** to On.

Check valve maximum pressure differential – Maximum cushion differential pressure

0.1 MPa (default) | positive scalar

Maximum cushion valve differential pressure. This parameter provides an upper limit to the pressure so that system pressures remain realistic.

Dependencies

To enable this parameter, set **Cylinder A end cushioning** to On.

Check valve maximum area – Area of fully opened cushion valve1e-4 m² (default) | positive scalar

Cross-sectional area of the cushion valve in its fully open position.

Dependencies

To enable this parameter, set **Cylinder A end cushioning** to On.

Check valve leakage area – Cushion valve gap area when in fully closed position1e-10 m² (default) | positive scalar

Sum of all gaps when the cushion check valve is in a fully closed position. Any area smaller than this value is saturated to the specified leakage area. This value contributes to numerical stability by maintaining continuity in the flow.

Dependencies

To enable this parameter, set **Cylinder A end cushioning** to On.

Converter Cushion B**Cylinder B end cushioning – Whether to model piston slow-down at maximum extension**

Off (default) | On

Whether to model piston slow-down at maximum extension. See the Cylinder Cushion (IL) block for more information.

Cushion plunger cross-sectional area — Cylinder cushion plunger area

1e-4 m² (default) | positive scalar

Area of the plunger inside the actuator cushion element.

Dependencies

To enable this parameter, set **Cylinder B end cushioning** to On.

Cushion plunger length — Length of cushion plunger

1e-3 m (default) | positive scalar

Length of the cushion plunger.

Dependencies

To enable this parameter, set **Cylinder B end cushioning** to On.

Cushion orifice area — Area of orifice between cushion chambers

1e-6 m² (default) | positive scalar

Area of the orifice between cushion chambers.

Dependencies

To enable this parameter, set **Cylinder B end cushioning** to On.

Leakage area between plunger and cushion sleeve — Gap between cushion plunger and sleeve

1e-7 m² (default) | positive scalar

Gap area between the cushion plunger and sleeve. This value contributes to numerical stability by maintaining continuity in the flow.

Dependencies

To enable this parameter, set **Cylinder B end cushioning** to On.

Check valve cracking pressure differential — Cushion threshold pressure

0.01 MPa (default) | positive scalar

Pressure beyond which the valve operation is triggered. When the pressure difference between port **A** and P_{env} meets or exceeds the **Check valve cracking pressure differential**, the cushion valve begins to open.

Dependencies

To enable this parameter, set **Cylinder B end cushioning** to On.

Check valve maximum pressure differential — Maximum cushion differential pressure

0.1 MPa (default) | positive scalar

Maximum cushion valve differential pressure. This parameter provides an upper limit to the pressure so that system pressures remain realistic.

Dependencies

To enable this parameter, set **Cylinder B end cushioning** to On.

Check valve maximum area — Area of fully opened cushion valve

1e-4 m² (default) | positive scalar

Cross-sectional area of the cushion valve in its fully open position.

Dependencies

To enable this parameter, set **Cylinder B end cushioning** to On.

Check valve leakage area — Cushion valve gap area when in fully closed position

1e-10 m² (default) | positive scalar

Sum of all gaps when the cushion check valve is in a fully closed position. Any area smaller than this value is saturated to the specified leakage area. This value contributes to numerical stability by maintaining continuity in the flow.

Dependencies

To enable this parameter, set **Cylinder B end cushioning** to On.

Smoothing factor — Numerical smoothing factor

0.01 (default) | positive scalar

Continuous smoothing factor that introduces a layer of gradual change to the flow response when the variable orifice and check valve are in near-open or near-closed positions. Set this value to a nonzero value less than one to increase the stability of your simulation in these regimes.

Dependencies

To enable this parameter, set **Cylinder B end cushioning** to On.

Friction**Cylinder friction effect — Whether to model friction against piston motion**

Off (default) | On

Whether to model friction against piston motion. The model accounts for Coulomb, Stribeck, and viscous friction. See the Cylinder Friction block for more information.

Preload force — Initial force on cylinder

20 N (default) | scalar

Force on the cylinder when it is in the neutral position.

Dependencies

To enable this parameter, set **Cylinder friction effect** to On.

Coulomb friction force coefficient — Coulomb friction force coefficient

1e-6 N/Pa (default) | positive scalar

Coulomb force coefficient of friction.

Dependencies

To enable this parameter, set **Cylinder friction effect** to On.

Viscous friction coefficient – Viscous friction coefficient

100 N/(m/s) (default) | positive scalar

Viscous friction coefficient.

Dependencies

To enable this parameter, set **Cylinder friction effect** to On.

Leakage**Internal leakage – Whether to model annular leakage**

Off (default) | On

Whether to model annular leakage between the fluid chamber and the piston reservoir at reference environment conditions. The leakage is considered laminar. See the Laminar Leakage (IL) block for more information.

Piston-cylinder clearance – Radial clearance

1e-4 m (default) | positive scalar

Radial distance between the piston rod and cylinder casing.

Dependencies

To enable this parameter, set **Internal leakage** to On.

Piston head length – Annular length of piston mounting

0.01 m (default) | positive scalar

Annular length of the piston mounting, not including the piston rod.

Dependencies

To enable this parameter, set **Internal leakage** to On.

Initial Conditions**Piston displacement from chamber A cap – Method for determining piston position**

Calculate from velocity of port R relative to port C (default) | Provide input signal from Multibody joint

Method for determining the piston position. The block can receive the position from a Multibody block when set to Provide input signal from Multibody joint, or calculates the position internally and reports the position at port **p**. The position is between 0 and the **Piston stroke** when the mechanical orientation is positive and 0 and **-Piston stroke** when the mechanical orientation is negative.

Initial piston displacement from chamber A cap – Piston position measured from chamber A cap at start of simulation

0 m (default) | scalar

Piston position with respect to the chamber A cap at the start of the simulation.

Dependencies

To enable this parameter, set **Piston displacement from chamber A cap** to Calculate from velocity of port R relative to port C.

Fluid dynamic compressibility – Whether to model fluid compressibility

On (default) | Off

Whether to model any change in fluid density due to fluid compressibility. When **Fluid compressibility** is set to On, changes due to the mass flow rate into the block are calculated in addition to density changes due to changes in pressure. In the Isothermal Liquid Library, all blocks calculate density as a function of pressure.

Initial liquid pressure in chamber A – Starting liquid pressure in chamber A

0.101325 MPa (default) | positive scalar

Starting liquid pressure for compressible fluids.

Dependencies

To enable this parameter, set **Fluid dynamic compressibility** to On.

Initial liquid pressure in chamber B – Starting liquid pressure in chamber B

0.101325 MPa (default) | positive scalar

Starting liquid pressure for compressible fluids.

Dependencies

To enable this parameter, set **Fluid dynamic compressibility** to On.

See Also

Single-Acting Actuator (IL) | Double-Acting Actuator (G-IL) | Double-Acting Rotary Actuator (IL) | Double-Acting Servo Valve Actuator (IL)

Topics

“Connecting Simscape Networks to Simscape Multibody Joints”

Introduced in R2020a

Double-Acting Actuator (TL)

Linear actuator with piston motion controlled by two opposing thermal liquid chambers

Library: Simscape / Fluids / Thermal Liquid / Actuators



Description

The Double-Acting Actuator (TL) block models a linear actuator with piston motion controlled by two opposing thermal liquid chambers. The actuator generates force in the extension and retraction strokes. The force generated depends on the pressure difference between the two chambers.

The figure shows the key components of the actuator model. Ports **A** and **B** represent the thermal liquid chamber inlets. Port **R** represents the translating actuator piston and port **C** the actuator case. Ports **HA** and **HB** represent the thermal interfaces between each chamber and the environment. The moving piston is adiabatic.

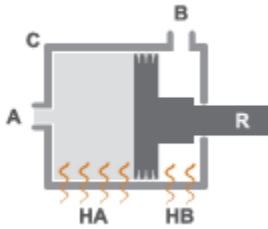

Double-Acting Actuator Schematic

Displacement

The piston displacement is measured as the position at port **R** relative to port **C**. The **Mechanical orientation** identifies the direction of piston displacement. The piston displacement is considered neutral, or θ , when the chamber A volume is equal to the chamber dead volume. When displacement is received as an input, ensure that the derivative of the position is equal to the piston velocity. This is automatically the case when the input is received from a Translational Multibody Interface block connection to a Simscape Multibody joint.

The direction of the piston motion depends on the mechanical orientation setting in the block dialog box. If the mechanical orientation is positive, then a higher pressure at port **A** yields a positive piston translation relative to the actuator case. The direction of motion reverses for a negative mechanical orientation.

Hard Stop

A set of hard stops limit the piston range of motion. The hard stops are treated as spring-damper systems. The spring stiffness coefficient controls the restorative component of the hard-stop contact force and the damping coefficient the dissipative component.

The hard stops are located at the distal ends of the piston stroke. If the mechanical orientation is positive, then the lower hard stop is at $x = 0$ and the upper hard stop at $x = +stroke$. If the

mechanical orientation is negative, then the lower hard stop is at $x = -stroke$ and the upper hard stop at $x = 0$.

Block Composite

This block is a composite component based on the Simscape Foundation blocks:

- Translational Mechanical Converter (TL)
- Translational Hard Stop
- Ideal Translational Motion Sensor

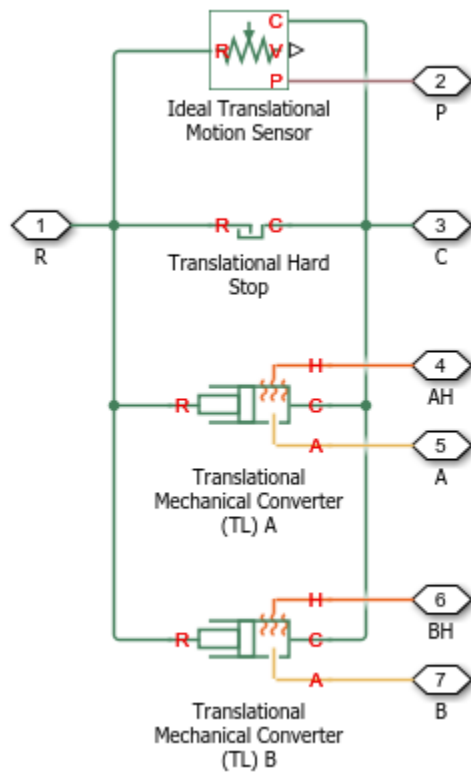

Composite Component Diagram

Ports

- A – Thermal liquid conserving port representing actuator chamber A
- B – Thermal liquid conserving port representing actuator chamber B
- C – Mechanical conserving port representing the actuator case
- R – Mechanical conserving port representing the actuator piston
- HA – Thermal conserving port representing the thermal interface between chamber A and the environment
- HB – Thermal conserving port representing the thermal interface between chamber B and the environment

- p — Physical signal input port for the piston position data. To expose this port, set **Piston displacement from chamber A cap** to Provide input signal from Multibody joint.
- p — Physical signal output port for the piston position data. To expose this port, set **Piston displacement from chamber A cap** to Calculate from velocity of port R relative to port C.

Parameters

Actuator Tab

Mechanical orientation

Sets the piston displacement direction. When you set this parameter to:

- Pressure at A causes positive displacement of R relative to C the piston displacement is positive when the volume of liquid at port A is expanding. This corresponds to rod extension.
- Pressure at A causes negative displacement of R relative to C the piston displacement is negative when the volume of liquid at port A is expanding. This corresponds to rod contraction.

The mechanical orientation affects the placement of the actuator hard stops. One hard stop is always at position zero. The second hard stop is at the piston stroke distance if the mechanical orientation is positive and at minus the piston stroke distance if the mechanical orientation is negative.

Piston cross-sectional area at A

Area normal to the direction of flow in actuator chamber A. The block uses this area to calculate the hydraulic force due to the fluid pressure in chamber A. The piston cross-sectional area must be greater than zero. The default value is 0.01 m^2 .

Piston cross-sectional area at B

Area normal to the direction of flow in actuator chamber B. The block uses this area to calculate the hydraulic force due to the fluid pressure in chamber B. The piston cross-sectional area must be greater than zero. The default value is 0.01 m^2 .

Piston stroke

Maximum distance the actuator piston can travel. The piston stroke must be greater than zero. The default value is 0.1 m .

Hard stops limit piston motion to the length of the piston stroke. One hard stop is located at position zero. The second hard stop is at the piston stroke distance if **Mechanical Orientation** is set to Pressure at A causes positive displacement of R relative to C and at minus the piston stroke if **Mechanical Orientation** is set to Pressure at A causes negative displacement of R relative to C.

Dead volume at A

Volume of liquid when the piston displacement is 0 in chamber A. This is the liquid volume when the piston is up against the actuator end cap. The default value is $1\text{e-}5 \text{ m}^3$.

Dead volume at B

Volume of liquid when the piston displacement is 0 in chamber B. This is the liquid volume when the piston is up against the actuator end cap. The default value is $1\text{e-}5 \text{ m}^3$.

Environment pressure specification

Choice of environment pressure. Options include Atmospheric pressure and Specified pressure. Selecting Specified pressure exposes an additional parameter, **Environment pressure**.

Environment pressure

Pressure outside the actuator casing. This pressure acts against the pressures inside the actuator chambers. A value of zero corresponds to a vacuum. The default value is 0.101325 MPa. This parameter is visible only when **Environment pressure specification** is set to Specified pressure.

Hard Stop Tab**Hard-stop stiffness coefficient**

Spring coefficient of the actuator hard stops. The spring coefficient accounts for the restorative portion of the hard-stop contact force. Increase the coefficient value to model harder contact. The default value is 1e10 N/m.

Hard-stop damping coefficient

Damping coefficient of the actuator hard stops. The damping coefficient accounts for the dissipative portion of the hard-stop contact force. Increase the coefficient value to reduce bounce upon contact. The default value is 150 N/(m/s).

Hard stop model

Modeling approach for hard stops. Options include:

- **Stiffness and damping applied smoothly through transition region (default)** — Scale the magnitude of the contact force from zero to its full value over a specified transition length. The scaling is polynomial in nature. The polynomial scaling function is numerically smooth and it produces no zero crossings of any kind.
- **Full stiffness and damping applied at bounds, undamped rebound** — Apply the full value of the calculated contact force when the hard-stop location is breached. The contact force is a mix of spring and damping forces during penetration and a spring force—without a damping component—during rebound. No smoothing is applied.
- **Full stiffness and damping applied at bounds, damped rebound** — Apply the full value of the calculated contact force when the hard-stop location is breached. The contact force is a mix of spring and damping forces during both penetration and rebound. No smoothing is applied. This is the hard-stop model used in previous releases.

Transition region

Distance below which scaling is applied to the hard-stop force. The contact force is zero when the distance to the hard stop is equal to the value specified here. It is at its full value when the distance to the hard stop is zero. The default value is 1mm.

Initial Conditions Tab**Piston displacement from chamber A cap**

Method for determining the piston position. The block can receive the position from a Multibody block when set to Provide input signal from Multibody joint. The default value is Calculate from velocity of port R relative to port C.

Initial piston displacement

Piston position at the start of simulation. This value must be between zero and the piston stroke if the **Mechanical orientation** parameter is set to Pressure at A causes positive

displacement of R relative to C. It must be between zero and minus the piston stroke if the **Mechanical orientation** parameter is set to Pressure at A causes negative displacement of R relative to C. The default value is 0 m. To enable this parameter, set **Piston displacement from chamber A cap** to Calculate from velocity of port R relative to port C.

Initial liquid temperature at A

Temperature in actuator chamber A at the start of simulation. The default value is 293.15 K.

Initial liquid temperature at B

Temperature in actuator chamber B at the start of simulation. The default value is 293.15 K.

Fluid dynamic compressibility

Option to model effects due to fluid dynamic compressibility. Select **On** to enable fluid dynamic compressibility and **Off** to disable it.

Initial liquid pressure in chamber A

Pressure in actuator chamber A at the start of simulation. The default value is 0.101325 MPa.

Initial liquid pressure in chamber B

Pressure in actuator chamber B at the start of simulation. The default value is 0.101325 MPa.

Extended Capabilities**C/C++ Code Generation**

Generate C and C++ code using Simulink® Coder™.

See Also

Double-Acting Actuator (TL-G) | Single-Acting Actuator (TL) | Double-Acting Actuator (IL)

Topics

“Connecting Simscape Networks to Simscape Multibody Joints”

Introduced in R2016a

Double-Acting Actuator (H-G)

(Not recommended) Linear actuator with opposing isothermal liquid and gas chambers

Note This block has been renamed in Simscape Fluids 3.0 (release 2020a). In Release 2019b and older, this block was named Double-Acting Actuator (H-G). Older models opened in R2020a currently work with the former version of this block.

Library: Simscape / Fluids / Fluid Network Interfaces / Actuators



Description

The Double-Acting Actuator (H-G) block models a linear actuator with opposing chambers of isothermal liquid and gas. The chambers can be individually pressurized to power the actuator in both the extension and retraction strokes. A piston between the chambers converts the pressure difference across them into actuation force.

The figure maps the conserving ports of the block to the actuator parts. Ports **A** and **B** are the inlets of the isothermal liquid and gas chambers. Ports **R** and **C** are the translating piston and case. The gas chamber can exchange heat with the environment and is fitted for this purpose with port **H**. The isothermal liquid, being of constant temperature, exchanges heat neither with the environment nor with the gas across the piston.

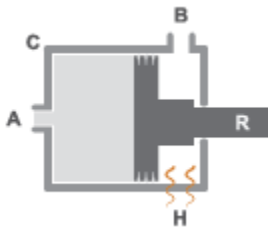

The sign of the piston displacement relative to the case depends on the mechanical orientation of the actuator. Use the **Mechanical orientation** parameter to specify this setting. If the mechanical orientation is positive, the piston displacement is positive when the pressure is highest in the isothermal liquid chamber (port **A**). If the mechanical orientation is negative, the piston displacement (under the same pressure conditions) is negative.

Use port **P** to output the instantaneous piston position. The position measurement can be absolute or relative. Configure the **Piston position display** parameter to switch the measurement type if needed:

- From piston initial distance from port A — The measurement is absolute. The first reading is the value specified in the **Piston initial distance from port A**. If that value is 10 in, the first reading is also 10 in.

- From zero — The measurement is relative to the initial piston position. The first reading, as it corresponds to the initial piston position, is zero.

Hard stops limit the motion of the piston to the length of the case. The stops are modeled as spring-dampers, with spring and damping coefficients to capture material compliance. One is located at the bottom of the piston stroke and the other at the top:

- If the **Mechanical orientation** setting is **Positive**, the bottom stop is at zero, and the top stop is at a distance equal to the piston stroke.
- If the **Mechanical orientation** setting is **Negative**, the top stop is at zero, and the bottom stop is at a distance equal to the piston stroke.

The block is a composite component built from Simscape Foundation blocks. For more information on how the Double-Acting Actuator (H-G) block works, see the reference pages of the constituent blocks:

- Translational Hydro-Mechanical Converter
- Translational Mechanical Converter (G)
- Translational Hard Stop
- Ideal Translational Motion Sensor

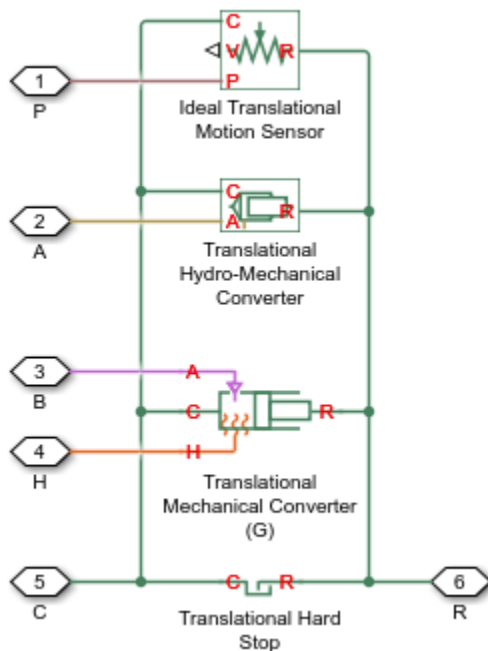

Ports

Output

P — Piston position, m

physical signal

Piston position measurement. The measurement can be absolute or relative to the initial piston position. Use the **Piston position display** parameter to specify the measurement type.

Conserving

A — Inlet to hydraulic chamber

hydraulic (isothermal liquid)

Hydraulic (isothermal liquid) conserving port representing the inlet to the hydraulic chamber of the actuator.

B — Inlet to gas chamber

gas

Gas conserving port representing the inlet to the gas chamber of the actuator.

R — Actuator piston

mechanical translational

Mechanical translational conserving port representing the actuator piston. The piston is capable of translational motion relative to the casing.

C — Actuator casing

mechanical translational

Mechanical translational conserving port representing the actuator casing. The casing serves as a mechanical reference for the motion of the piston.

H — Gas chamber thermal surface

thermal

Thermal conserving port representing the surface of the gas chamber through which heat exchange with the surroundings can occur. The thermal processes at this port determine the temperature in the gas chamber and therefore at port B.

Parameters

Hydraulic Side

Mechanical orientation — Direction of motion of the piston relative to the direction of flow of the fluid

Positive | Negative

Orientation of the actuator piston relative to the direction of fluid flow. A positive orientation causes the piston to move in the positive direction relative to the actuator casing in response to a positive flow rate through port A. The mechanical orientation affects the placement of the piston hard stops. See the block description for more information on the hard stop placement.

Piston cross-sectional area in chamber A — Cross-sectional area of the fluid volume in the hydraulic chamber

0.01 m² (default) | Scalar in units of area

Area normal to the direction of flow in the body of the hydraulic chamber. The block uses this area to calculate the hydraulic force due to the fluid pressure in the hydraulic chamber. This parameter must be greater than zero.

Piston stroke — Distance of travel of piston from hard stop to hard stop

0.1 m (default) | Scalar in units of length

Total distance of travel available to the piston, from one hard stop to the other. The hard stops limit the piston motion so that the piston is confined to stroke of the piston. See the block description for more information on the locations of the hard stops.

Piston position display — Reference against which to output piston position

From piston initial distance from port A (default) | From zero

Reference against which to measure the piston position. This setting reflects in the output of port **P**. Use the default setting, *From piston initial distance from port A*, to output the absolute piston position; the first position reading is then the value of the **Piston initial distance from port A** parameter. Use the alternative setting, *From zero*, to output the piston position relative to the specified initial value; the first position reading is then zero.

Piston initial distance from port A — Piston position relative to the hydraulic chamber inlet at the start of simulation

0 m (default) | Scalar in units of length

Distance of the piston from the hard stop closest to the hydraulic inlet at the start of simulation. Use this parameter to change the starting position of the piston. This parameter affects the placement of the piston hard stops. For more information on the hard stop placement, see the block description.

Fluid dynamic compressibility — Choice to model the effects of dynamic compressibility inside the hydraulic chamber

Off (default) | On

Option to model the effects of dynamic compressibility inside the hydraulic chamber. The hydraulic fluid is treated as compressible if this parameter is set to *On* and as incompressible if it is set to *Off*. The block ignores the dependence of the hydraulic fluid density on pressure and temperature if *Off* is selected.

Dead volume in chamber A — Fluid volume in the hydraulic chamber in the bottomed-out position

1e-4 m³ (default) | Scalar in units of volume

Hydraulic fluid volume remaining in the hydraulic chamber when the piston is pressed against the hard stop closest to the hydraulic inlet. The dead volume enables the block to capture the internal states of the hydraulic fluid volume—its pressure and temperature—when this volume is at a minimum. This parameter must be greater than zero.

Dependencies

This parameter is enabled when the **Compressibility** parameter is set to *On*.

Specific heat ratio — Specific heat ratio of the gas entrained in the hydraulic fluid

1.4 (default) | Unitless scalar

Ratio of the specific heat of the gas entrained in the hydraulic fluid at constant pressure to that at constant volume. The block uses this parameter in the calculations of density for the hydraulic fluid.

Dependencies

This parameter is enabled when the **Compressibility** parameter is set to *On*.

Initial liquid pressure (gauge) — Gauge pressure in the hydraulic chamber relative to the actuator environment

0 Pa (default) | Scalar in units of pressure

Pressure inside the hydraulic chamber at simulation time zero relative to absolute zero. This parameter helps set the initial states of the hydraulic fluid volume.

Dependencies

This parameter is enabled when the **Compressibility** parameter is set to On.

Gas Side

Piston cross-sectional area in chamber B — Cross-sectional area of the fluid volume in the gas chamber

1e-3 m² (default) | positive scalar in units of area

Area normal to the direction of flow in the body of the gas chamber. The block uses this area to calculate the pneumatic force due to the fluid pressure in the gas chamber. This parameter must be greater than zero.

Cross-sectional area at port B — Cross-sectional area of the inlet of the gas chamber

1e-3 m² (default) | positive scalar in units of area

Area normal to the direction of flow at the entrance to the gas chamber. The cross-sectional area at the entrance can differ from that in the body of the chamber. Set the two cross-sectional areas to different values to model the effects of a sudden area change at the inlet. This parameter must be greater than zero.

Dead volume in chamber B — Fluid volume in the gas chamber in the bottomed-out position

1e-4 m³ (default) | positive scalar in units of volume

Gas volume remaining in the gas chamber when the piston is pressed against the hard stop closest to the gas inlet. The dead volume enables the block to capture the internal states of the gas volume—its pressure and temperature—when this volume is at a minimum. This parameter must be greater than zero.

Initial gas pressure (absolute) — Absolute pressure inside the gas chamber at the start of simulation

0.101325 MPa (default) | scalar in units of pressure

Pressure inside the gas chamber at simulation time zero relative to absolute zero. This parameter helps set the initial state of the gas volume.

Environment pressure specification — Choice of atmospheric or custom environment pressure for the gas side

Atmospheric pressure (default) | Specified pressure

Option to set the environment pressure of the gas chamber to the typical value of one earth atmosphere or to a custom value. Selecting **Specified pressure** exposes an additional parameter, **Environment pressure**, that you use to specify a custom pressure.

Environment pressure — Absolute pressure of the environment outside the gas chamber

0.101325 MPa (default) | scalar in units of pressure

Pressure outside the gas chamber relative to absolute zero. This pressure acts against the pressure inside the gas chamber. A pressure of zero corresponds to a perfect vacuum.

Dependencies

This parameter is enabled when the **Environment pressure specification** is set to Specified pressure.

Hard Stop

Hard-stop stiffness coefficient — Stiffness coefficient for the restorative portion of the hard-stop contact force

1e6 N/m (default) | scalar in units of force/length

Spring coefficient for use in the spring-damper model of the piston hard-stops. The spring force is assumed to be the same at both hard stops. Increase the coefficient value to model harder contact.

Hard-stop damping coefficient — Damping coefficient for the dissipative portion of the hard-stop contact force

150 N/(m/s) (default) | scalar in units of force/velocity

Damping coefficient for use in the spring-damper model of the piston hard stops. The damping force is assumed to be the same at both hard stops. Increase the coefficient value to reduce piston bounce on contact.

Hard stop model — Modeling approach for hard stops

Stiffness and damping applied smoothly through transition region (default) | Full stiffness and damping applied at bounds, undamped rebound | Full stiffness and damping applied at bounds, damped rebound

Modeling approach for hard stops. Options include:

- **Stiffness and damping applied smoothly through transition region** — Scale the magnitude of the contact force from zero to its full value over a specified transition length. The scaling is polynomial in nature. The polynomial scaling function is numerically smooth and it produces no zero crossings of any kind.
- **Full stiffness and damping applied at bounds, undamped rebound** — Apply the full value of the calculated contact force when the hard-stop location is breached. The contact force is a mix of spring and damping forces during penetration and a spring force—without a damping component—during rebound. No smoothing is applied.
- **Full stiffness and damping applied at bounds, damped rebound** — Apply the full value of the calculated contact force when the hard-stop location is breached. The contact force is a mix of spring and damping forces during both penetration and rebound. No smoothing is applied. This is the hard-stop model used in previous releases.

Transition region — Distance below which scaling is applied to the hard-stop force

0.1 mm (default) | scalar in units of length

Distance below which scaling is applied to the hard-stop force. The contact force is zero when the distance to the hard stop is equal to the value specified here. It is at its full value when the distance to the hard stop is zero.

Extended Capabilities

C/C++ Code Generation

Generate C and C++ code using Simulink® Coder™.

See Also

Double-Acting Actuator (G-IL) | Double-Acting Actuator (TL-G) | Double-Acting Actuator (TL) | Double-Acting Hydraulic Cylinder | Double-Acting Hydraulic Cylinder (Simple)

Introduced in R2016b

Double-Acting Actuator (G-IL)

Linear actuator with isothermal liquid and gas chambers

Library: Simscape / Fluids / Fluid Network Interfaces / Actuators

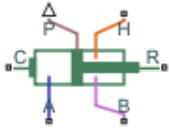

Description

The Double-Acting Actuator (G-IL) block models an isothermal liquid chamber and a gas chamber separated by a piston plate. The piston actuation is controlled by the pressure differential between the chambers. The motion of the piston when it is near full extension or full retraction is limited by one of three hard stop models.

Port **A** is the isothermal liquid inlet and port **B** is the gas inlet. Connect elements for heat transfer between the gas chamber and the environment to port **H**. Port **C** acts as a mechanical translational reference for the actuator casing. Port **R** is associated with the actuator piston. The piston position is reported at port **P**.

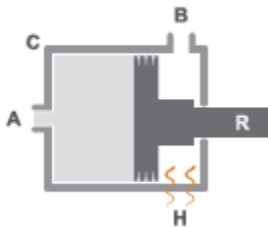

Displacement

The piston displacement is measured as the position at port **R** relative to port **C**. The **Mechanical orientation** identifies the direction of piston displacement. The piston displacement is neutral, or θ , when the chamber volume is equal to the chamber dead volume. When displacement is received as an input, ensure that the derivative of the position is equal to the piston velocity. This is automatically the case when the input is received from a Translational Multibody Interface block connection to a Simscape Multibody joint.

Hard Stop Model

To avoid mechanical damage to the piston when it is fully extended or fully retracted, an actuator typically displays nonlinear behavior when the piston approaches these limits. The Double-Acting Actuator (G-IL) block models this behavior with a choice of three hard stop models, which model the material compliance through a spring-damper system. The hard stop models are:

- Stiffness and damping applied smoothly through transition region, damped rebound.
- Full stiffness and damping applied at bounds, undamped rebound.

- Full stiffness and damping applied at bounds, damped rebound.

The hard stop force is modeled when the piston is at its upper or lower bound. The boundary region is within the **Transition region** of the **Piston stroke** or piston initial displacement. Outside of this region, $F_{HardStop} = 0$.

For more information about these settings, see the Translational Hard Stop block page.

Block Schematic

The Double-Acting Actuator (G-IL) block is a composite of four Simscape Foundation blocks:

- Translational Mechanical Converter (G)
- Translational Mechanical Converter (IL)
- Translational Hard Stop
- Ideal Translational Motion Sensor

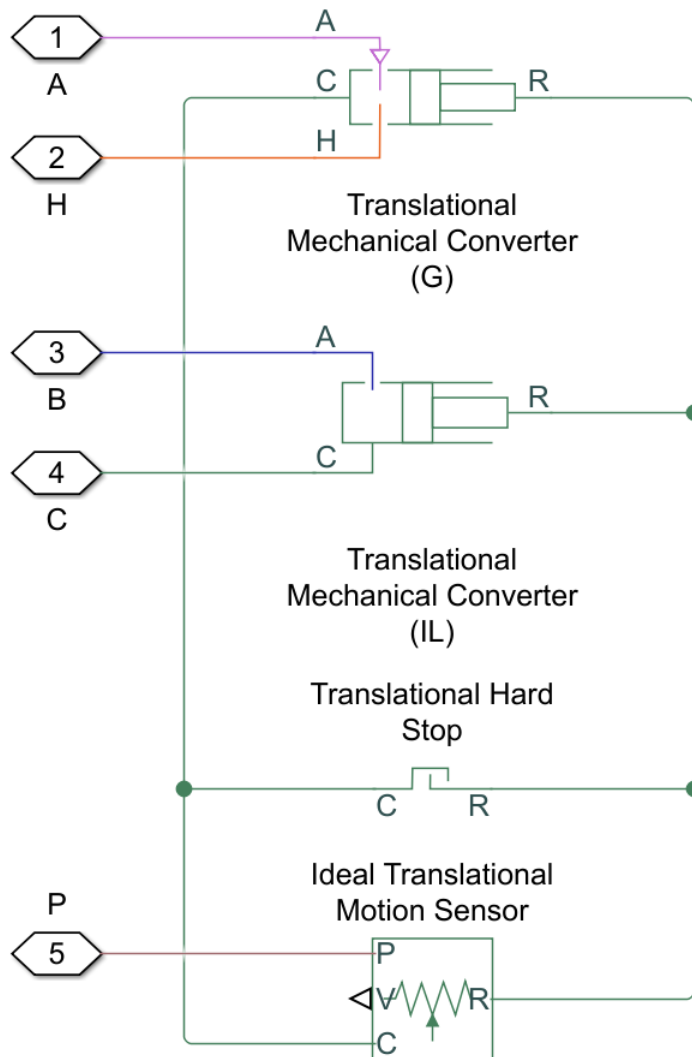

Ports

Conserving

A — Liquid chamber inlet port

isothermal liquid

Inlet port to the liquid chamber.

B — Gas chamber inlet port

gas

Inlet port to the gas chamber.

C — Actuator casing

mechanical translational

Mechanical translational conserving port associated with the actuator reference velocity and force.

R — Actuator piston

mechanical translational

Mechanical translational conserving port associated with the piston velocity and force.

H — Heat transfer port

isothermal liquid

Heat transfer to or from the gas chamber.

Output

p — Piston position, m

physical signal

Piston position in m, returned as a physical signal.

Parameters

Configuration

Mechanical orientation — Piston displacement direction

Pressure at A causes positive displacement of R relative to C (default) | Pressure at A causes negative displacement of R relative to C

Piston displacement direction. Pressure at A causes positive displacement of R relative to C corresponds to piston extension when the pressure difference between chambers A and B is positive. Pressure at A causes negative displacement of R relative to C corresponds to piston retraction when the pressure difference between chambers A and B is positive.

Piston stroke — Maximum piston travel distance

0.1 m (default) | positive scalar

Maximum piston travel distance.

Initial piston displacement from chamber A cap – Piston position at start of simulation

0 m (default) | scalar

Piston position at the start of the simulation.

Hard-stop stiffness coefficient – Stiffness coefficient

1e10 N/m (default) | positive scalar

Piston stiffness coefficient.

Hard-stop damping coefficient – Damping coefficient

150 N/(m/s) (default) | positive scalar

Piston damping coefficient for motion near the piston ends.

Hard stop model – Model choice for force on piston at full extension or retraction

Stiffness and damping applied smoothly through transition region, damped rebound (default) | Full stiffness and damping applied at bounds, undamped rebound | Full stiffness and damping applied at bounds, damped rebound

Model choice for the force on the piston at full extension or full retraction. See the Translational Hard Stop block for more information.

Transition region – Application range of hard stop force model

0.1 mm (default) | positive scalar

Application range of the hard stop force model. Outside of the range of the piston maximum extension and piston maximum retraction, the **Hard stop model** is not applied and there is no additional force on the piston.**Dependencies**To enable this parameter, set **Hard stop model** to Stiffness and damping applied smoothly through transition region, damped rebound.**Isothermal Liquid Side****Piston cross-sectional area in chamber A – Cross-sectional area of piston rod**0.01 m² (default) | positive scalar

Cross-sectional area of the piston rod in chamber A.

Dead volume in chamber A – Chamber volume at full piston retraction1e-5 m³ (default) | positive scalar

Open volume in the fluid chamber when the piston is fully retracted.

Fluid dynamic compressibility – Whether to model fluid compressibility

On (default) | Off

Whether to model any change in fluid density due to fluid compressibility. When **Fluid compressibility** is set to On, changes due to the mass flow rate into the block are calculated in addition to density changes due to changes in pressure. In the Isothermal Liquid Library, all blocks calculate density as a function of pressure.

Initial liquid pressure in chamber A — Initial liquid pressure for compressible fluids

0.101325 MPa (default) | positive scalar

Initial liquid pressure for compressible fluids.

Dependencies

To enable this parameter, set **Fluid dynamic compressibility** to On.

Environment pressure specification — Reference environment pressure

Atmospheric pressure (default) | Specified pressure

Environment reference pressure. The Atmospheric pressure option sets the environmental pressure to 0.101325 MPa.

Environment pressure — User-defined environmental pressure

0.101325 MPa (default) | positive scalar

User-defined environmental pressure.

Dependencies

To enable this parameter, set **Environment pressure specification** to Specified pressure.

Gas Side**Piston cross-sectional area in chamber B — Cross-sectional area of piston rod**

0.01 m² (default) | positive scalar

Cross-sectional area of the piston rod in chamber B.

Cross-sectional area at port B — Port cross-sectional area

1e-3 m² (default) | positive scalar

Cross-sectional area at port B.

Dead volume in chamber B — Chamber volume at full piston retraction

1e-5 m³ (default) | positive scalar

Open volume in the gas chamber when the piston is fully retracted.

Initial gas pressure in chamber B — Starting gas chamber pressure

0.101325 MPa (default) | positive scalar

Initial pressure in the gas chamber.

Initial gas temperature in chamber B — Starting gas chamber temperature

293.15 K (default) | positive scalar

Initial temperature in the gas chamber.

Environment pressure specification — Reference environment pressure

Atmospheric pressure (default) | Specified pressure

Environment reference pressure. The Atmospheric pressure option sets the environmental pressure to 0.101325 MPa.

Environment pressure — User-defined environmental pressure

0.101325 MPa (default) | positive scalar

User-defined environmental pressure.

Dependencies

To enable this parameter, set **Environment pressure specification** to Specified pressure.

See Also

Double-Acting Actuator (IL) | Double-Acting Actuator (TL-G) | Double-Acting Rotary Actuator (IL) | Double-Acting Servo Valve Actuator (IL)

Topics

“Connecting Simscape Networks to Simscape Multibody Joints”

Introduced in R2020a

Double-Acting Actuator (TL-G)

Linear actuator with opposing thermal liquid and gas chambers

Library: Simscape / Fluids / Fluid Network Interfaces / Actuators



Description

The Double-Acting Actuator (TL-G) block models a linear actuator with opposing chambers of thermal liquid and gas. The chambers can be individually pressurized to power the actuator in both extension and retraction strokes. A piston between the chambers converts the pressure difference across them into actuation force.

The figure maps the conserving ports of the block to the actuator parts. Ports **A** and **B** are the inlets of the thermal liquid and gas chambers. Ports **R** and **C** are the translating piston and case. The chambers can exchange heat with the environment and are fitted for this purpose with ports **HA** and **HB**. The piston is perfectly insulating. The thermal liquid and gas chambers do not exchange heat with each other.

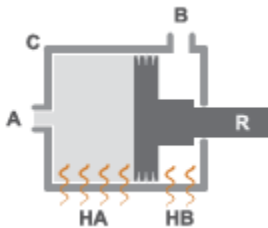

The sign of the piston displacement relative to the case depends on the mechanical orientation of the actuator. Use the **Mechanical orientation** parameter to specify this setting. If the mechanical orientation is positive, the piston displacement is positive when the pressure is highest in the thermal liquid chamber (port **A**). If the mechanical orientation is negative, the piston displacement (under the same pressure conditions) is negative.

Use port **P** to output the instantaneous piston position. The measurement is absolute (relative to zero). Hard stops limit the motion of the piston to the length of the case. The stops are modeled as spring-dampers, with spring and damping coefficients to capture material compliance. One is located at the bottom of the piston stroke and the other at the top:

- If the **Mechanical orientation** setting is **Positive**, the bottom stop is at zero, and the top stop is at a distance equal to the piston stroke.
- If the **Mechanical orientation** setting is **Negative**, the top stop is at zero, and the bottom stop is at a distance equal to the piston stroke.

The block is a composite component built from Simscape Foundation blocks. For more information on how the Double-Acting Actuator (TL-G) block works, see the reference pages of the constituent blocks:

- Translational Mechanical Converter (TL)
- Translational Mechanical Converter (G)
- Translational Hard Stop
- Ideal Translational Motion Sensor

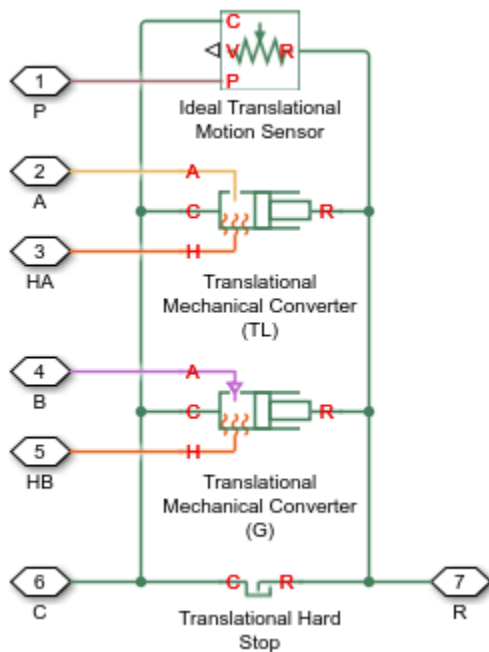

Ports

Output

P – Piston position, m

physical signal

Piston position measurement. The measurement is absolute. The first reading is the value of the **Piston initial displacement** parameter.

Conserving

A – Inlet to thermal liquid chamber

hydraulic (isothermal liquid)

Hydraulic (isothermal liquid) conserving port representing the inlet to the hydraulic chamber of the actuator.

B – Inlet to gas chamber

gas

Gas conserving port representing the inlet to the gas chamber of the actuator.

R – Actuator piston

mechanical translational

Mechanical translational conserving port representing the actuator piston. The piston is capable of translational motion relative to the casing.

C – Actuator casing

mechanical translational

Mechanical translational conserving port representing the actuator casing. The casing serves as a mechanical reference for the motion of the piston.

HA – Heat exchange surface of the thermal liquid chamber

Thermal

Thermal conserving port representing the surface through which heat exchange can occur between the thermal liquid volume and the actuator surroundings. The thermal processes at this port influence the temperature in the thermal liquid chamber and therefore at port A.

HB – Heat exchange surface of the gas chamber

Thermal

Thermal conserving port representing the surface through which heat exchange can occur between the gas volume and the actuator surroundings. The thermal processes at this port influence the temperature in the gas chamber and therefore at port A.

Parameters**Thermal liquid Side****Mechanical orientation – Direction of motion of the piston relative to the direction of flow of the fluid**

Positive | Negative

Orientation of the actuator piston relative to the direction of fluid flow. A positive orientation causes the piston to move in the positive direction relative to the actuator casing in response to a positive flow rate through port A. The mechanical orientation affects the placement of the piston hard stops. See the block description for more information on the hard stop placement.

Piston cross-sectional area in chamber A – Cross-sectional area of the fluid volume in the thermal liquid chamber

0.01 m² (default) | scalar in units of area

Area normal to the direction of flow in the body of the thermal liquid chamber. The block uses this area to calculate the hydraulic force due to the fluid pressure in the thermal liquid chamber. This parameter must be greater than zero.

Piston stroke – Distance of travel of the piston from hard stop to hard stop

0.2 m (default) | scalar in units of length

Total distance of travel available to the piston, from one hard stop to the other. The hard stops limit the piston motion so that the piston is confined to stroke of the piston. See the block description for more information on the locations of the hard stops.

Piston initial displacement – Position of the piston at the start of simulation

0 m (default) | scalar in units of length

Absolute position of the piston at the start of simulation. The zero position coincides with the lower hard stop if the mechanical orientation is positive and with the upper hard stop if the mechanical orientation is negative.

Dead volume in chamber A — Fluid volume in the thermal liquid chamber in the bottomed-out position

1e-4 m³ (default) | scalar in units of volume

Thermal liquid volume remaining in the thermal liquid chamber when the piston is pressed against the hard stop closest to the thermal liquid inlet. The dead volume enables the block to capture the internal states of the thermal liquid volume—its pressure and temperature—when this volume is at a minimum. This parameter must be greater than zero.

Fluid dynamic compressibility — Choice to model the effects of dynamic compressibility inside the thermal liquid chamber

On (default) | Off

Option to model the effects of dynamic compressibility inside the thermal liquid chamber. The thermal liquid is treated as compressible if this parameter is set to On and as incompressible if it is set to Off. The block ignores the dependence of the thermal liquid density on pressure and temperature if Off is selected.

Initial liquid pressure in chamber A — Absolute pressure in the thermal liquid chamber

0.101325 Pa (default) | scalar in units of pressure

Pressure inside the thermal liquid chamber at simulation time zero relative to absolute zero. This parameter helps set the initial states of the thermal liquid volume.

Dependencies

This parameter is enabled when the **Compressibility** parameter is set to On.

Initial liquid temperature in chamber A — Temperature in the thermal liquid chamber at the start of simulation

293.15 K (default) | scalar in units of temperature

Average temperature inside the thermal liquid chamber at the start of simulation. This parameter helps set the initial states of the thermal liquid volume.

Environment pressure specification — Choice of atmospheric or custom environment pressure for the thermal liquid side

Atmospheric pressure (default) | Specified pressure

Option to set the environment pressure of the thermal liquid chamber to the typical value of one earth atmosphere or to a custom value. Selecting **Specified pressure** exposes an additional parameter, **Environment pressure**, that you use to specify a custom pressure.

Environment pressure — Absolute pressure of the environment outside the thermal liquid chamber

0.101325 MPa (default) | scalar in units of pressure

Pressure outside the thermal liquid chamber relative to absolute zero. This pressure acts against the pressure inside the thermal liquid chamber. A pressure of zero corresponds to a perfect vacuum.

Dependencies

This parameter is enabled when the **Environment pressure specification** is set to Specified pressure.

Gas Side**Piston cross-sectional area in chamber B — Cross-sectional area of the fluid volume in the gas chamber**

1e-3 m² (default) | positive scalar in units of area

Area normal to the direction of flow in the body of the gas chamber. The block uses this area to calculate the pneumatic force due to the fluid pressure in the gas chamber. This parameter must be greater than zero.

Cross-sectional area at port B — Cross-sectional area of the inlet of the gas chamber

1e-3 m² (default) | positive scalar in units of area

Area normal to the direction of flow at the entrance to the gas chamber. The cross-sectional area at the entrance can differ from that in the body of the chamber. Set the two cross-sectional areas to different values to model the effects of a sudden area change at the inlet. This parameter must be greater than zero.

Dead volume in chamber B — Fluid volume in the gas chamber in the bottomed-out state

1e-4 m³ (default) | positive scalar in units of volume

Gas volume remaining in the gas chamber when the piston is pressed against the hard stop closest to the gas inlet. The dead volume enables the block to capture the internal states of the gas volume—its pressure and temperature—when this volume is at a minimum. This parameter must be greater than zero.

Initial gas pressure (absolute) — Absolute pressure inside the gas chamber at the start of simulation

0.101325 MPa (default) | scalar in units of pressure

Pressure inside the gas chamber at simulation time zero relative to absolute zero. This pressure helps set the initial state of the gas volume.

Environment pressure specification — Choice of atmospheric or custom environment pressure for the gas side

Atmospheric pressure (default) | Specified pressure

Option to set the environment pressure of the gas chamber to the typical value of one earth atmosphere or to a custom value. Selecting Specified pressure exposes an additional parameter, **Environment pressure**, that you use to specify a custom pressure.

Environment pressure — Absolute pressure of the environment outside the gas chamber

0.101325 MPa (default) | scalar in units of pressure

Pressure outside the gas chamber relative to absolute zero. This pressure acts against the pressure inside the gas chamber. A pressure of zero corresponds to a perfect vacuum.

Dependencies

This parameter is enabled when the **Environment pressure specification** is set to Specified pressure.

Hard Stop**Hard-stop stiffness coefficient — Stiffness coefficient for the restorative portion of the hard-stop contact force**

1e6 N/m (default) | scalar in units of force/length

Spring coefficient for use in the spring-damper model of the piston hard-stops. The spring force is assumed to be the same at both hard stops. Increase the coefficient value to model harder contact.

Hard-stop damping coefficient — Damping coefficient for the dissipative portion of the hard-stop contact force

150 N/(m/s) (default) | scalar in units of force/velocity

Damping coefficient for use in the spring-damper model of the piston hard stops. The damping force is assumed to be the same at both hard stops. Increase the coefficient value to reduce piston bounce on contact.

Hard stop model — Modeling approach for hard stops

Stiffness and damping applied smoothly through transition region (default) | Full stiffness and damping applied at bounds, undamped rebound | Full stiffness and damping applied at bounds, damped rebound

Modeling approach for hard stops. Options include:

- Stiffness and damping applied smoothly through transition region — Scale the magnitude of the contact force from zero to its full value over a specified transition length. The scaling is polynomial in nature. The polynomial scaling function is numerically smooth and it produces no zero crossings of any kind.
- Full stiffness and damping applied at bounds, undamped rebound — Apply the full value of the calculated contact force when the hard-stop location is breached. The contact force is a mix of spring and damping forces during penetration and a spring force—without a damping component—during rebound. No smoothing is applied.
- Full stiffness and damping applied at bounds, damped rebound — Apply the full value of the calculated contact force when the hard-stop location is breached. The contact force is a mix of spring and damping forces during both penetration and rebound. No smoothing is applied. This is the hard-stop model used in previous releases.

Transition region — Distance below which scaling is applied to the hard-stop force

0.1 mm (default) | scalar in units of length

Distance below which scaling is applied to the hard-stop force. The contact force is zero when the distance to the hard stop is equal to the value specified here. It is at its full value when the distance to the hard stop is zero.

Extended Capabilities**C/C++ Code Generation**

Generate C and C++ code using Simulink® Coder™.

See Also

Double-Acting Actuator (TL) | Double-Acting Actuator (G-IL) | Double-Acting Actuator (H-G) | Double-Acting Hydraulic Cylinder | Double-Acting Hydraulic Cylinder (Simple)

Introduced in R2016b

Double-Acting Hydraulic Cylinder

Hydraulic actuator exerting force in both directions



Library

Hydraulic Cylinders

Description

The Double-Acting Hydraulic Cylinder block models a device that converts hydraulic energy into mechanical energy in the form of translational motion. Hydraulic fluid pumped under pressure into one of the two cylinder chambers forces the piston to move and exert force on the cylinder rod. Double-acting cylinders transfer force and motion in both directions.

Connections **R** and **C** are mechanical translational conserving ports corresponding to the cylinder rod and cylinder clamping structure, respectively. Connections **A** and **B** are hydraulic conserving ports. Port **A** is connected to converter **A** and port **B** is connected to converter **B**.

The energy through hydraulic port **A** or **B** is directed to the appropriate Translational Hydro-Mechanical Converter block. The converter transforms hydraulic energy into mechanical energy and accounts for the fluid compressibility in the cylinder chamber. The rod motion is limited with the mechanical Translational Hard Stop block in such a way that the rod can travel only between cylinder caps.

Displacement

The piston displacement is measured as the position at port **R** relative to port **C**. The **Cylinder orientation** identifies the direction of piston displacement. The piston displacement is neutral, or θ , when the chamber A volume is equal to the chamber dead volume. When displacement is received as an input, ensure that the derivative of the position is equal to the piston velocity. This is automatically the case when the input is received from a Translational Multibody Interface block connection to a Simscape Multibody joint.

Composite Structure

The model of the cylinder is built of Simscape Foundation library blocks. The schematic diagram of the model is shown below.

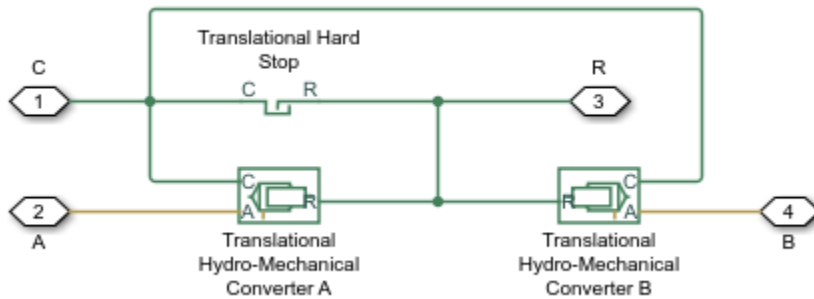

Basic Assumptions and Limitations

- No leakage, internal or external, is taken into account.
- No loading on piston rod, such as inertia, friction, spring, and so on, is taken into account. If necessary, you can easily add them by connecting an appropriate building block to cylinder port R.

Parameters

Basic Parameters Tab

Piston area A

Chamber A effective piston area. The default value is $1e-3 \text{ m}^2$.

Piston area B

Chamber B effective piston area. The default value is $0.5e-3 \text{ m}^2$.

Piston stroke

Piston maximum travel between caps. The default value is 0.1 m .

Dead volume A

Fluid volume in chamber A that remains in the chamber after the rod is fully retracted. The default value is $1e-4 \text{ m}^3$.

Dead volume B

Fluid volume in chamber B that remains in the chamber after the rod is fully extended. The default value is $1e-4 \text{ m}^3$.

Specific heat ratio

Gas-specific heat ratio for the Hydraulic Piston Chamber blocks. The default value is 1.4 .

Cylinder orientation

Specifies cylinder orientation with respect to the globally assigned positive direction. The cylinder can be installed in two different ways, depending upon whether it exerts force in the positive or in the negative direction when pressure is applied at its inlet. If pressure applied at port A exerts force in negative direction, set the parameter to **Pressure at A causes negative displacement of R relative to C**. The default value is **Pressure at A causes positive displacement of R relative to C**.

Hard Stop Properties Tab

Contact stiffness

Specifies the elastic property of colliding bodies for the Translational Hard Stop block. The greater the value of the parameter, the less the bodies penetrate into each other, the more rigid the impact becomes. Lesser value of the parameter makes contact softer, but generally improves convergence and computational efficiency. The default value is $1e6$ N/m.

Contact damping

Specifies dissipating property of colliding bodies for the Translational Hard Stop block. At zero damping, the impact is close to an absolutely elastic one. The greater the value of the parameter, the more energy dissipates during an interaction. Keep in mind that damping affects slider motion as long as the slider is in contact with the stop, including the period when slider is pulled back from the contact. For computational efficiency and convergence reasons, MathWorks recommends that you assign a nonzero value to this parameter. The default value is 150 N*s/m.

Hard stop model

Modeling approach for hard stops. Options include:

- **Stiffness and damping applied smoothly through transition region (default)** — Scale the magnitude of the contact force from zero to its full value over a specified transition length. The scaling is polynomial in nature. The polynomial scaling function is numerically smooth and it produces no zero crossings of any kind.
- **Full stiffness and damping applied at bounds, undamped rebound** — Apply the full value of the calculated contact force when the hard-stop location is breached. The contact force is a mix of spring and damping forces during penetration and a spring force—without a damping component—during rebound. No smoothing is applied.
- **Full stiffness and damping applied at bounds, damped rebound** — Apply the full value of the calculated contact force when the hard-stop location is breached. The contact force is a mix of spring and damping forces during both penetration and rebound. No smoothing is applied. This is the hard-stop model used in previous releases.

Transition region

Distance below which scaling is applied to the hard-stop force. The contact force is zero when the distance to the hard stop is equal to the value specified here. It is at its full value when the distance to the hard stop is zero. The default value is 0.1 mm.

Initial Conditions Tab

Piston displacement from cap A

Method for determining the piston position. The block can receive the position from a Multibody block when set to **Provide input signal from Multibody joint**, which exposes the physical signal port **p**. The default value is **Calculate from velocity of port R relative to port C**.

Initial piston displacement from cap A

The distance that the piston is extended at the beginning of simulation. You can set the piston position to any point within its stroke. The default value is 0 , which corresponds to the fully retracted position. To enable this parameter, set **Piston displacement from cap A** to **Calculate from velocity of port R relative to port C**.

Chamber A initial pressure

Pressure in the cylinder chamber A at the beginning of simulation. The default value is 0 .

Chamber B initial pressure

Pressure in the cylinder chamber B at the beginning of simulation. The default value is 0.

Restricted Parameters

When your model is in Restricted editing mode, you cannot modify the following parameter:

- **Cylinder orientation**

All other block parameters are available for modification.

Global Parameters

Parameter determined by the type of working fluid:

- **Fluid bulk modulus**

Use the Hydraulic Fluid block or the Custom Hydraulic Fluid block to specify the fluid properties.

Ports

The block has the following ports:

A

Hydraulic conserving port associated with the cylinder chamber A.

B

Hydraulic conserving port associated with the cylinder chamber B.

R

Mechanical translational conserving port associated with the cylinder rod.

C

Mechanical translational conserving port associated with the cylinder clamping structure.

p

Piston position, received as a physical signal from a Simscape Multibody block. To expose this port, set **Piston displacement from cap A** to Provide input signal from Multibody joint.

Examples

The “Hydraulic Cylinder with Flexible Mount” example illustrates simulation of a cylinder whose clamping is too flexible to be neglected. The structure compliance is represented with a spring and a damper, installed between the cylinder case and reference point. The cylinder performs forward and return strokes, and is loaded with inertia, viscous friction, and constant opposing load of 400 N.

The “Custom Hydraulic Cylinder” example demonstrates the use of a 4-way valve in combination with a double-acting cylinder in a simple closed-loop actuator. The example shows how to connect the blocks and set the initial orifice openings for the 4-way valve to model the forward and return strokes of the cylinder under load.

Extended Capabilities

C/C++ Code Generation

Generate C and C++ code using Simulink® Coder™.

See Also

Single-Acting Hydraulic Cylinder | Ideal Translational Motion Sensor | Translational Hard Stop | Translational Hydro-Mechanical Converter

Topics

“Upgrading Simscape Fluids Models Containing Hydraulics (Isothermal) Blocks”

Introduced in R2006a

Double-Acting Hydraulic Cylinder (Simple)

Basic functionality of double-acting hydraulic cylinder



Library

Hydraulic Cylinders

Description

The Double-Acting Hydraulic Cylinder (Simple) block represents a simplified version of a double-acting hydraulic cylinder, developed for applications where only the basic cylinder functionality must be reproduced, in exchange for better numerical efficiency. For these reasons, such factors as fluid compressibility, friction, and leakages are assumed to be negligible. The hard stops are assumed to be fully inelastic, to eliminate any possible oscillations at the end of the stroke. The model is especially suitable for real-time and HIL (hardware-in-the-loop) simulation, if such simplifications are acceptable.

The model is described with the following equations:

$$F = A_A \cdot p_A - A_B \cdot p_B - F_c$$

$$q_A = A_A \cdot v$$

$$q_B = A_B \cdot v$$

$$\frac{dx}{dt} = v$$

$$v = v_R - v_C$$

$$F_c = \begin{cases} (x - x_E) \cdot K_p \cdot v & \text{if } x > x_E, v > 0 \\ (x - x_R) \cdot K_p \cdot v & \text{if } x < x_R, v < 0 \\ 0 & \text{otherwise} \end{cases}$$

$$x_E = S - x_0$$

$$x_R = -x_0$$

where

F	Force developed by the cylinder
v	Cylinder rod velocity
v_R, v_C	Absolute velocities of cylinder rod and cylinder case, respectively

A_A	Piston area at port A side
A_B	Piston area at port B side
p_A	Pressure at the cylinder port A
p_B	Pressure at the cylinder port B
q_A	Flow rate through port A into the cylinder
q_B	Flow rate through port B from the cylinder
x	Piston position
x_0	Initial distance between piston and cap A
F_c	Hard stop force
x_E	Distance the piston can travel to fully extend from initial position
x_R	Distance the piston can travel to fully retract from initial position
K_p	Penetration coefficient
S	Piston stroke

The main difference between this block and the Double-Acting Hydraulic Cylinder block is the representation of the hard stop:

- The Double-Acting Hydraulic Cylinder block utilizes the elastic model of the stop, which is essentially a combination of a spring and a damper, connected in parallel. The stiffness of the spring, which represents contact stiffness of colliding bodies, is very high, resulting in high-frequency, low-magnitude oscillations at the moment the bodies collide. These oscillations can hardly be noticed experimentally, but they are difficult to process by a numerical simulation and generally decrease numerical efficiency.
- The hard stop in the Double-Acting Hydraulic Cylinder (Simple) block is represented with the inelastic model, which is essentially a viscous damper with the penetration-dependent damping coefficient. This coefficient is referred to as the penetration coefficient. With inelastic model, no oscillation is generated during an impact, resulting in improved numerical robustness and efficiency. But inelastic stop model has a feature that you must consider while selecting the model: colliding bodies continue slowly moving into each other as long as the contact is loaded with the compressing force. In real life, this phenomenon is similar to collision of two bodies separated by a sizable layer of viscous liquid. It takes some time to squeeze the liquid before bodies themselves come into contact.

Connections R and C are mechanical translational conserving ports corresponding to the cylinder rod and cylinder clamping structure, respectively. Connections A and B are hydraulic conserving ports. Port A is connected to chamber A and port B is connected to chamber B.

You can adjust the block directionality with the **Cylinder orientation** parameter.

Basic Assumptions and Limitations

- Friction between moving parts is not taken into account.
- Inertia effects are not taken into account.
- Fluid compressibility is not taken into account.
- Leakage flows are assumed to be negligible.
- The hard stops are assumed to be fully inelastic, as explained above.

Parameters

Piston area A

Chamber A effective piston area. The default value is 0.001 m^2 .

Piston area B

Chamber B effective piston area. The default value is $5e-4 \text{ m}^2$.

Piston stroke

Piston maximum travel between caps. The default value is 0.1 m .

Piston initial distance from cap A

The distance between the piston and cap A at the beginning of simulation. This value cannot exceed the piston stroke. The default value is 0 .

Penetration coefficient

Specifies the penetration property of colliding bodies. The higher the value of the coefficient, the less the bodies penetrate into each other, but the sharper the increase of the impact force. To find out the value of the coefficient for a particular application, it is recommended to run the same model with different hard stop models (or with different cylinder models) until they show close results. The default value of the coefficient is $1e12 \text{ N/m/(m/s)}$.

Cylinder orientation

Specifies cylinder orientation with respect to the globally assigned positive direction. The cylinder can be installed in two different ways, depending upon whether it exerts force in the positive or in the negative direction when pressure is applied at its inlet. If pressure applied at port A exerts force in negative direction, set the parameter to `Acts in negative direction`. The default value is `Acts in positive direction`.

Restricted Parameters

When your model is in Restricted editing mode, you cannot modify the following parameter:

- **Cylinder orientation**

All other block parameters are available for modification.

Ports

The block has the following ports:

A

Hydraulic conserving port associated with the cylinder chamber A.

B

Hydraulic conserving port associated with the cylinder chamber B.

R

Mechanical translational conserving port associated with the cylinder rod.

C

Mechanical translational conserving port associated with the cylinder clamping structure.

Examples

The “Closed-Loop Hydraulic Actuator Model for Real-Time Simulation” example shows how to use this cylinder along with other blocks optimized for real-time and HIL simulation.

Extended Capabilities

C/C++ Code Generation

Generate C and C++ code using Simulink® Coder™.

See Also

[Double-Acting Hydraulic Cylinder](#) | [Single-Acting Hydraulic Cylinder](#) | [Single-Acting Hydraulic Cylinder \(Simple\)](#) | [Translational Hard Stop](#) | [Translational Hydro-Mechanical Converter](#)

Topics

“Upgrading Simscape Fluids Models Containing Hydraulics (Isothermal) Blocks”

Introduced in R2010a

Double-Acting Rotary Actuator (IL)

Double-acting rotary actuator in an isothermal liquid system

Library: Simscape / Fluids / Isothermal Liquid / Actuators



Description

The Double-Acting Rotary Actuator (IL) block models a rotary actuator in an isothermal liquid network. The actuator converts the pressure differential between two chambers into mechanical torque. The motion of the piston when it is near full extension or full retraction is limited by one of three hard stop models.

Ports **A** and **B** are the isothermal liquid conserving ports associated with inlets of chamber A and chamber B, respectively. Port **R** is associated with the actuator shaft and port **C** is associated with the reference actuator casing. If **Mechanical orientation** is set to Pressure at A causes positive rotation of R relative to C, the pressure in chamber A causes a positive rotation of the shaft at port **R** relative to port **C**. When the shaft angle is calculated internally, the physical signal port **q** reports the shaft angle. When the angle is set by a connection to a Simscape Multibody joint, it is received as a physical signal at port **q**.

Displacement

The piston displacement is measured as the position at port **R** relative to port **C**. The **Mechanical orientation** identifies the direction of piston displacement. The piston displacement is neutral, or θ , when the chamber volume is equal to the chamber dead volume. When displacement is received as an input, ensure that the derivative of the position is equal to the piston velocity. This is automatically the case when the input is received from a Rotational Multibody Interface block connection to a Simscape Multibody joint.

Hard Stop Model

To avoid mechanical damage to an actuator when it is fully extended or fully retracted, an actuator typically displays nonlinear behavior when the piston approaches these limits. The Single-Acting Rotary Actuator (IL) block models this behavior with a choice of three hard stop models, which model the material compliance through a spring-damper system. The hard stop models are:

- Stiffness and damping applied smoothly through transition region, damped rebound.
- Full stiffness and damping applied at bounds, undamped rebound.
- Full stiffness and damping applied at bounds, damped rebound.

The hard stop force is modeled when the piston is at its upper or lower bound. The boundary region is within the **Transition region** of the **Stroke** or piston initial displacement. Outside of this region, $F_{HardStop} = 0$.

For more information about these settings, see the Rotational Hard Stop block page.

Block Schematics

The Double-Acting Rotary Actuator (IL) block comprises three Foundation Library blocks:

- Ideal Rotational Motion Sensor
- Rotational Hard Stop
- Rotational Mechanical Converter (IL)

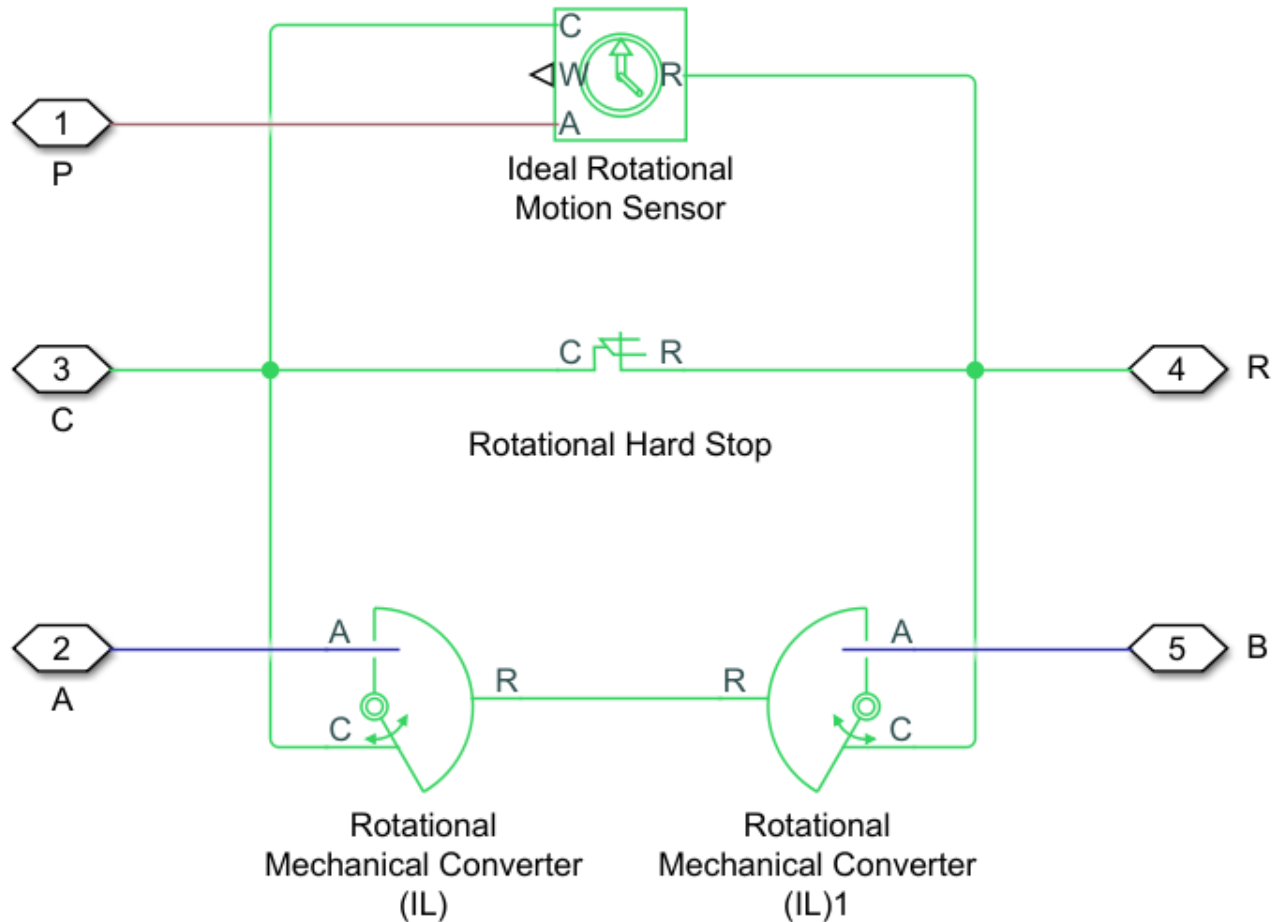

Underlying Block Components

Leakage

Laminar leakage is not accounted for in the Double-Acting Rotary Actuator (IL) block. To include leakage in your simulation, set the **Cross-sectional geometry** parameter to Custom and connect ports **A** and **B** to ports **A** and **B** of a Laminar Leakage (IL) block.

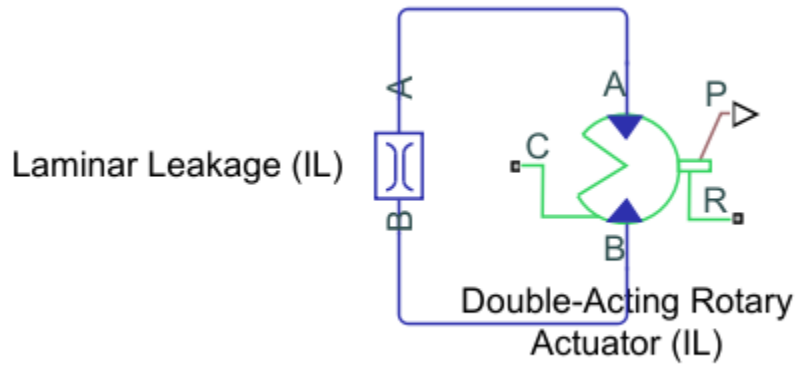

Adding Leakage to the Simulation

Ports

Conserving

A – Liquid port for chamber A

isothermal liquid

Isothermal liquid conserving port associated with the actuator chamber A.

B – Liquid port for chamber B

isothermal liquid

Isothermal liquid conserving port associated with the actuator chamber B.

R – Actuator shaft

mechanical translational

Mechanical rotational conserving port associated with the shaft angular velocity and torque.

C – Actuator casing

mechanical translational

Mechanical rotational conserving port associated with the reference cylinder casing.

Input

q – Shaft angle

physical signal

Shaft angle, received as a physical signal from a Simscape Multibody block.

Dependencies

To expose this port, set **Shaft rotation from chamber A** to Provide input signal from Multibody joint.

Output

q – Actuator angle

physical signal

Shaft angle, reported as a physical signal.

Dependencies

To expose this port, set **Shaft rotation from chamber A** to Calculate from angular velocity of port R relative to port C.

Parameters

Actuator

Mechanical orientation – Piston displacement direction

Pressure at A causes positive displacement of R relative to C (default) | Pressure at A causes negative displacement of R relative to C

Sets the piston displacement direction. When you set this parameter to:

- Pressure at A causes positive displacement of R relative to C the piston displacement is positive when the volume of liquid at port A is expanding. This corresponds to rod extension.
- Pressure at A causes negative displacement of R relative to C the piston displacement is negative when the volume of liquid at port A is expanding. This corresponds to rod contraction.

Volume displacement in chamber A – Volume displacement

$1e-4 \text{ m}^3/\text{rad}$ (default) | positive scalar

Effective displacement of the actuator in chamber A.

Volume displacement in chamber B – Volume displacement

$1e-4 \text{ m}^3/\text{rad}$ (default) | positive scalar

Effective displacement of the actuator in chamber B.

Stroke – Angle

5.0 rad (default) | positive scalar

Shaft maximum travel between stops.

Dead volume in chamber A – Fluid volume

$1e-5 \text{ m}^3$ (default) | positive scalar

Volume of liquid when the piston displacement is 0 in chamber A. This is the liquid volume when the piston is up against the actuator end cap.

Dead volume in chamber B – Fluid volume

$1e-5 \text{ m}^3$ (default) | positive scalar

Volume of liquid when the piston displacement is 0 in chamber B. This is the liquid volume when the piston is up against the actuator end cap.

Environment pressure specification – Pressure reference source

Atmospheric pressure (default) | Specified pressure

Choice of environment pressure. Options include Atmospheric pressure and Specified pressure.

Environment pressure – User-defined pressure reference

0.101325 MPa (default) | positive scalar

Pressure outside the actuator casing. This pressure acts against the pressures inside the actuator chambers. A value of zero corresponds to a vacuum.

Dependencies

To enable this parameter, set **Environment pressure specification** to Specified pressure.

Hard Stop**Hard stop stiffness coefficient – Stiffness coefficient**

1e6 N*m/rad (default) | positive scalar

Specifies the elasticity for the Rotational Hard Stop block. The greater the value of the parameter, the more rigid the impact between the rod and the stop becomes. Lower values result in softer contact and generally improve simulation efficiency and convergence.

Hard stop damping coefficient – Damping coefficient

150 N*m(rad/s) (default) | positive scalar

Specifies the dissipating property of colliding bodies for the Rotational Hard Stop block. At zero damping, the impact is elastic. The greater the value of the parameter, the greater the energy dissipation during piston-stop interaction. Damping affects slider motion as long as the slider is in contact with the stop, including the period when slider is pulled back from the contact. Set this parameter to a nonzero value to improve the efficiency and convergence of your simulation.

Hard stop model – Model choice for force on piston at full extension or retraction

Stiffness and damping applied smoothly through transition region, damped rebound (default) | Full stiffness and damping applied at bounds, undamped rebound | Full stiffness and damping applied at bounds, damped rebound

Model choice for the force on the piston at full extension or full retraction. See the Rotational Hard Stop block for more information.

Transition region – Transition region

0.001 rad (default) | positive scalar

Distance below which scaling is applied to the hard-stop force. The contact force is zero when the distance to the hard stop is equal to the value of this parameter. The contact force is at its full value when the distance to the hard stop is zero.

Initial Conditions**Shaft rotation from chamber A – Method for determining shaft angle**

Calculate from velocity of port R relative to port C (default) | Provide input signal from Multibody joint

Method for determining the shaft angle. The block can receive the angle from a Multibody block when set to **Provide input signal from Multibody joint**, or calculates the angle internally, which is reported at port **q**.

Initial shaft rotation from chamber A — Initial rotation

0 rad (default) | scalar

The position of the actuator at the beginning of simulation. This value falls between 0 and the value of the **Stroke** in the positive orientation, and 0 and the negative value of the **Stroke** in the negative orientation.

Dependencies

To enable this parameter, set **Shaft rotation from chamber A** to **Calculate from velocity of port R relative to port C**.

Fluid dynamic compressibility — Fluid compressibility

On (default) | Off

Whether to model any change in fluid density due to fluid compressibility. When **Fluid compressibility** is set to **On**, changes due to the mass flow rate into the block are calculated in addition to density changes due to changes in pressure. In the Isothermal Liquid Library, all blocks calculate density as a function of pressure.

Initial liquid pressure in chamber A — Liquid pressure

0.101325 MPa (default) | positive scalar

Pressure in actuator chamber A at the start of simulation.

Dependencies

To enable this parameter, set **Fluid dynamic compressibility** to **On**.

Initial liquid pressure in chamber B — Liquid pressure

0.101325 MPa (default) | positive scalar

Pressure in actuator chamber B at the start of simulation.

Dependencies

To enable this parameter, set **Fluid dynamic compressibility** to **On**.

See Also

Double-Acting Actuator (IL) | Double-Acting Actuator (G-IL) | Single-Acting Rotary Actuator (IL) | Rotating Single-Acting Actuator (IL) | Single-Acting Actuator (IL)

Topics

“Connecting Simscape Networks to Simscape Multibody Joints”

Introduced in R2020a

Double-Acting Rotary Actuator

Double-acting hydraulic rotary actuator



Library

Hydraulic Cylinders

Description

The Double-Acting Rotary Actuator block models a double-acting hydraulic rotary actuator, which directly converts hydraulic energy into mechanical rotational energy without employing intermediary transmissions such as rack-and-pinion, sliding spline, chain, and so on. Hydraulic fluid pumped under pressure into one of the two actuator chambers forces the shaft to rotate and generate torque. Double-acting actuators generate torque and motion in both directions.

The model of the actuator is built of Simscape Foundation library blocks. The schematic diagram of the model is shown below.

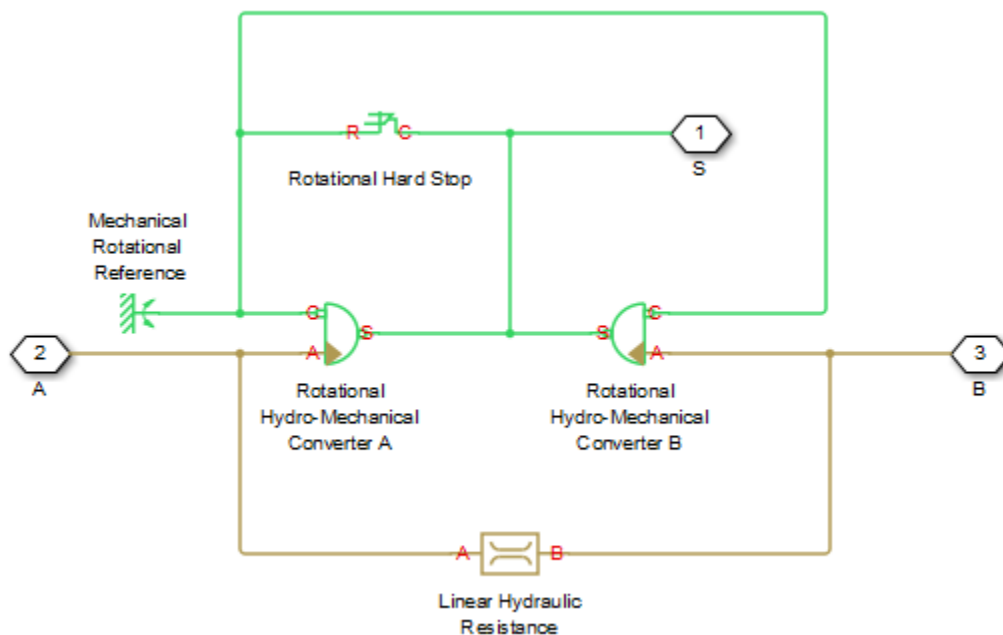

The blocks in the diagram perform the following functions:

Rotational Hydro-Mechanical Converter A	Converts hydraulics energy into mechanical rotational energy when fluid is pumped into actuator chamber A, while accounting for fluid compressibility.
Rotational Hydro-Mechanical Converter B	Converts hydraulics energy into mechanical rotational energy when fluid is pumped into actuator chamber B, while accounting for fluid compressibility.
Rotational Hard Stop	Imposes limits on shaft rotation.
Linear Hydraulic Resistance	Accounts for leakages.

Connections A and B are hydraulic conserving ports. Port A is connected to chamber A and port B is connected to chamber B. Connection S is a mechanical rotational conserving port associated with the actuator shaft.

The block directionality is adjustable and can be controlled with the **Actuator orientation** parameter.

Basic Assumptions and Limitations

No loading, such as inertia, friction, spring, and so on, is taken into account. If necessary, you can easily add them by connecting an appropriate building block to port S.

Parameters

Actuator displacement

Effective displacement of the actuator. The default value is $4.5e-5 \text{ m}^3/\text{rad}$.

Shaft stroke

Shaft maximum travel between stops. The default value is 5.1 rad .

Shaft initial angle

The position of the shaft at the beginning of simulation. You can set the shaft position to any angle within its stroke. The default value is 0 , which corresponds to the shaft position at the very beginning of the stroke.

Dead volume A

Fluid volume in chamber A that remains in the chamber when the shaft is positioned at the very beginning of the stroke. The default value is $1e-4 \text{ m}^3$.

Dead volume B

Fluid volume in chamber B that remains in the chamber when the shaft is positioned at the end of the stroke. The default value is $1e-4 \text{ m}^3$.

Leak coefficient

Leak coefficient for the Linear Hydraulic Resistance block. The default value is $1e-14 \text{ (m}^3/\text{s)/Pa}$.

Specific heat ratio

Gas-specific heat ratio for the Hydraulic Piston Chamber block. The default value is 1.4 .

Contact stiffness

Specifies the elastic property of colliding bodies for the Rotational Hard Stop block. The greater the value of the parameter, the less the bodies penetrate into each other, the more rigid the

impact becomes. Lesser value of the parameter makes contact softer, but generally improves convergence and computational efficiency. The default value is $1e6$ N*m/rad.

Contact damping

Specifies dissipating property of colliding bodies for the Rotational Hard Stop block. At zero damping, the impact is close to an absolutely elastic one. The greater the value of the parameter, the more energy dissipates during an interaction. Keep in mind that damping affects slider motion as long as the slider is in contact with the stop, including the period when slider is pulled back from the contact. For computational efficiency and convergence reasons, MathWorks recommends that you assign a nonzero value to this parameter. The default value is 150 N*m/(rad/s).

Hard stop model

Modeling approach for hard stops. Options include:

- **Stiffness and damping applied smoothly through transition region (default)** — Scale the magnitude of the contact force from zero to its full value over a specified transition length. The scaling is polynomial in nature. The polynomial scaling function is numerically smooth and it produces no zero crossings of any kind.
- **Full stiffness and damping applied at bounds, undamped rebound** — Apply the full value of the calculated contact force when the hard-stop location is breached. The contact force is a mix of spring and damping forces during penetration and a spring force—without a damping component—during rebound. No smoothing is applied.
- **Full stiffness and damping applied at bounds, damped rebound** — Apply the full value of the calculated contact force when the hard-stop location is breached. The contact force is a mix of spring and damping forces during both penetration and rebound. No smoothing is applied. This is the hard-stop model used in previous releases.

Transition region

Distance below which scaling is applied to the hard-stop force. The contact force is zero when the distance to the hard stop is equal to the value specified here. It is at its full value when the distance to the hard stop is zero. The default value is 1 mm..

Actuator orientation

Specifies actuator orientation with respect to the globally assigned positive direction. The actuator can be installed in two different ways, depending upon whether it generates torque in the positive or in the negative direction when pressure is applied at its inlet. If pressure applied at port A generates torque in the negative direction, set the parameter to `Acts in negative direction`. The default value is `Acts in positive direction`.

Restricted Parameters

When your model is in Restricted editing mode, you cannot modify the following parameter:

- **Actuator orientation**

All other block parameters are available for modification.

Global Parameters

Parameter determined by the type of working fluid:

- **Fluid bulk modulus**

Use the Hydraulic Fluid block or the Custom Hydraulic Fluid block to specify the fluid properties.

Ports

The block has the following ports:

A

Hydraulic conserving port associated with the actuator chamber A.

B

Hydraulic conserving port associated with the actuator chamber B.

S

Mechanical rotational conserving port associated with the actuator shaft.

Extended Capabilities

C/C++ Code Generation

Generate C and C++ code using Simulink® Coder™.

See Also

Linear Hydraulic Resistance | Rotational Hard Stop | Rotational Hydro-Mechanical Converter

Topics

“Upgrading Simscape Fluids Models Containing Hydraulics (Isothermal) Blocks”

Introduced in R2007a

Double-Acting Servo Valve Actuator (IL)

Double-acting servo cylinder with spring-centered spool in an isothermal liquid system

Library: Simscape / Fluids / Valve Actuators & Forces

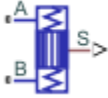

Description

The Double-Acting Servo Valve Actuator (IL) block models a double-acting servo cylinder arranged as a spring-centered spool. The spring neutral position is where the spool is located at the middle of the stroke. The motion of the piston when it is near full extension or full retraction is limited by one of three hard stop models. Fluid compressibility is optionally modeled in both piston chambers.

The physical signal output **P** reports the spool position.

Hard Stop Model

To avoid mechanical damage to an actuator when it is fully extended or fully retracted, an actuator typically displays nonlinear behavior when the piston approaches these limits. The Double-Acting Servo Valve Actuator (IL) block models this behavior with a choice of three hard stop models, which model the material compliance through a spring-damper system. The hard stop models are:

- Stiffness and damping applied smoothly through transition region, damped rebound.
- Full stiffness and damping applied at bounds, undamped rebound.
- Full stiffness and damping applied at bounds, damped rebound.

The hard stop force is modeled when the piston is at its upper or lower bound. The boundary region is within the **Transition region** of the **Spool stroke** or piston initial displacement. Outside of this region, $F_{HardStop} = 0$.

For more information about these settings, see the Translational Hard Stop block page.

Block Schematic

The Double-Acting Servo Actuator block comprises an Isothermal Liquid library block and two Simscape Foundation blocks:

- Double-Acting Actuator (IL)
- Translational Spring
- Translational Damper

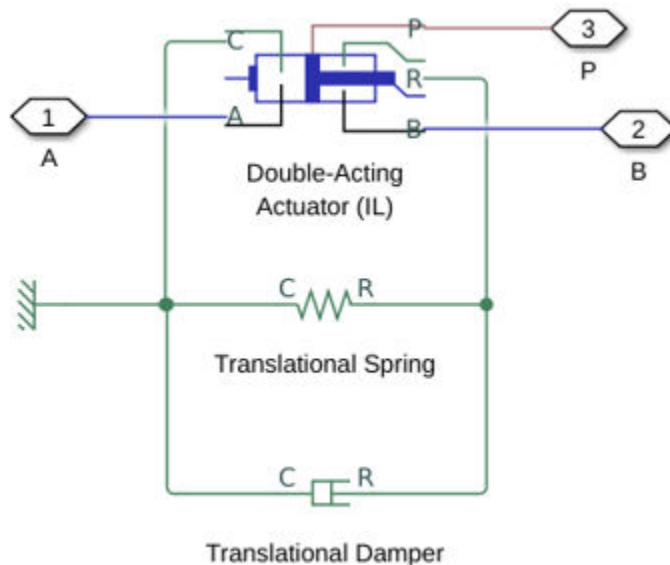

Ports

Conserving

A – Liquid port for chamber A

isothermal liquid

Isothermal liquid conserving port associated with the liquid inlet of chamber A.

B – Liquid port for chamber B

isothermal liquid

Isothermal liquid conserving port associated with the liquid inlet of chamber B.

Output

P – Spool position, in m

physical signal

Physical signal of the spool position, in m, specified as a physical signal. A position of zero indicates that the spool is at a neutral position in the middle of a stroke.

Parameters

Cylinder

Spool cross-sectional area – Area measurement

$1e-4 \text{ m}^2$ (default) | positive scalar

Cross-sectional area of the spool

Spool stroke – Distance

$5e-3 \text{ m}$ (default) | positive scalar

Distance the spool travels in a stroke.

Spring stiffness — Rate of force for the spring

1e3 N/m (default) | scalar

Spring rate of the centering springs.

Damping coefficient — Damping coefficient

150 N/(m/s) (default) | positive scalar

Damping coefficient in the contact between the piston and the case.

Hard Stop**Hard stop stiffness coefficient — Stiffness coefficient**

1e10 N/m (default) | positive scalar

Specifies the elasticity for the hard stop model. The greater the value of the parameter, the more rigid the impact between the rod and the stop becomes. Lower values result in softer contact and generally improve simulation efficiency and convergence.

Hard stop damping coefficient — Damping coefficient

150 N/(m/s) (default) | positive scalar

Specifies dissipating property of colliding bodies for the hard stop model. At zero damping, the impact is elastic. The greater the value of the parameter, the greater the energy dissipation during piston-stop interaction. Damping affects slider motion as long as the slider is in contact with the stop, including the period when slider is pulled back from the contact. Set this parameter to a nonzero value to improve the efficiency and convergence of your simulation.

Hard stop model — Model hard stops

Stiffness and damping applied smoothly through transition region, damped rebound (default) | Full stiffness and damping applied at bounds, undamped rebound | Full stiffness and damping applied at bounds, damped rebound

Modeling approach for hard stops.

- **Stiffness and damping applied smoothly through transition region, damped rebound** — Specify a transition region in which the torque is scaled from zero. At the end of the transition region, the full stiffness and damping are applied. This model has damping applied on the rebound, but it is limited to the value of the stiffness torque. Damping can reduce or eliminate the torque provided by the stiffness, but never exceed it. All equations are smooth and produce no zero crossings.
- **Full stiffness and damping applied at bounds, undamped rebound** — This model has full stiffness and damping applied with impact at the upper and lower bounds and no damping on the rebound. The equations produce no zero crossings when velocity changes sign, but there is a position-based zero crossing at the bounds. Having no damping on rebound helps to push the slider past this position quickly. This model has nonlinear equations.
- **Full stiffness and damping applied at bounds, damped rebound** — This model has full stiffness and damping applied with impact at the upper and lower bounds and damping applied on the rebound. The equations are switched linear, but produce position-based zero crossings. Use this hard stop model if `simscape.findNonlinearBlocks` indicates that this is the block that prevents the whole network from being switched linear.

Transition region — Transition region

0.001 rad (default) | positive scalar

Distance below which scaling is applied to the hard-stop force. The contact force is zero when the distance to the hard stop is equal to the value of this parameter. The contact force is at its full value when the distance to the hard stop is zero.

Effects and Initial Conditions**Spool initial displacement — Initial location of the spool**

0 m (default) | scalar

When the initial displacement of the spool is set to 0, the spool begins directly between chamber A and chamber B. A positive distance moves the spool away from chamber A, while a negative amount moves the spool toward chamber A.

Fluid dynamic compressibility — Fluid compressibility

On (default) | Off

Whether to model any change in fluid density due to fluid compressibility. When **Fluid compressibility** is set to On, changes due to the mass flow rate into the block are calculated in addition to density changes due to changes in pressure. In the Isothermal Liquid Library, all blocks calculate density as a function of pressure.

Initial liquid pressure in chamber A — Liquid pressure

0.101325 MPa (default) | positive scalar

Pressure in actuator chamber A at the start of simulation.

Dependencies

To enable this parameter, set **Fluid dynamic compressibility** to On.

Initial liquid pressure in chamber B — Liquid pressure

0.101325 MPa (default) | positive scalar

Pressure in actuator chamber B at the start of simulation.

Dependencies

To enable this parameter, set **Fluid dynamic compressibility** to On.

See Also

Double-Acting Actuator (IL) | Double-Acting Actuator (G-IL) | Double-Acting Rotary Actuator (IL) | Single-Acting Actuator (IL)

Introduced in R2020a

Double-Acting Servo Cylinder

Hydraulic double-acting servo cylinder with spring-centered plunger

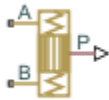

Library

Valve Actuators

Description

The Double-Acting Servo Cylinder block models a hydraulic double-acting servo cylinder implemented as a spring-centered plunger.

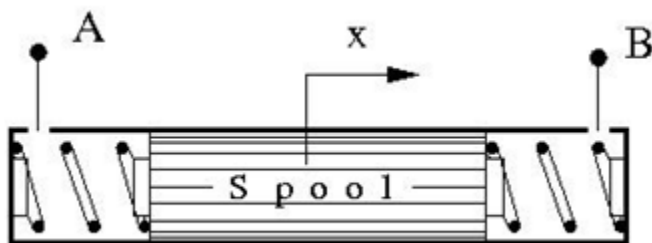

Changing pressure at ports A and B shifts the spool from the neutral position in proportion to the pressure differential. Use the servo cylinder for control purposes.

The model of the cylinder uses the Double-Acting Hydraulic Cylinder (Simple), Translational Spring, Translational Damper, and Ideal Translational Motion Sensor blocks. The following figure shows the schematic diagram of the model.

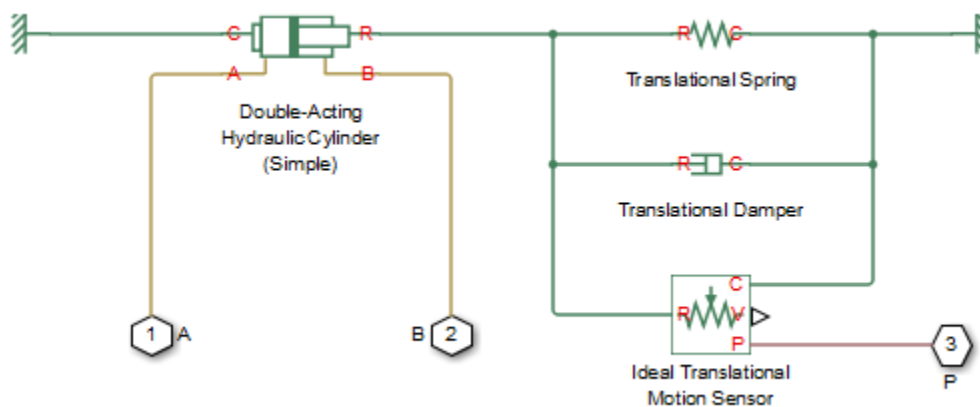

The plunger is located initially in the middle of the stroke. The plunger displacement is computed with the following equations:

$$A(p_A - p_B) = k \cdot x + B \cdot v + F_{HS}$$

$$F_{HS} = \begin{cases} (x - S/2) \cdot K_p \cdot v & \text{if } x > S/2, v > 0 \\ (x + S/2) \cdot K_p \cdot \text{abs}(v) & \text{if } x < -S/2, v < 0 \\ 0 & \text{otherwise} \end{cases}$$

where

p_A, p_B	Pressures at port A and B, respectively
A	Spool face area
k	Spring rate
B	Damping coefficient
F_{HS}	Hard stop force
K_p	Stop penetration coefficient
S	Piston stroke
v	Piston velocity
x	Piston displacement

Connection P is a physical signal output port that outputs the plunger displacement from the central position. Connections A and B are hydraulic conserving ports. Pressure at port A moves the plunger in the positive direction.

Basic Assumptions and Limitations

- Friction between moving parts is not taken into account.
- Inertia effects are not taken into account.
- Fluid compressibility is not taken into account.
- Leakage flows are assumed to be negligible.
- The hard stops are assumed to be fully inelastic. For details, see the Double-Acting Hydraulic Cylinder (Simple) block reference page.

Parameters

Piston area

The face area of the piston. The default value is $1e-4 \text{ m}^2$.

Piston stroke

The full piston stroke, from one hard stop to another. The piston is located initially in the middle of the stroke and can travel half a stroke in the positive and negative direction. The default value is 0.005 m .

Spring rate

The spring rate of the centering springs. The default value is 1000 N/m .

Damping coefficient

The damping coefficient in the contact between the piston and the case. The default value is 150 N/(m/s).

Stop penetration coefficient

The penetration property of the piston hard stop. The hard stop is represented as absolutely inelastic, and the property is characterized by the penetration coefficient. The default value of the coefficient is 1e12 N/m/(m/s).

Ports

The block has the following ports:

A

Hydraulic conserving port associated with the cylinder chamber A.

B

Hydraulic conserving port associated with the cylinder chamber B.

P

Physical signal output port that outputs the piston displacement.

Extended Capabilities**C/C++ Code Generation**

Generate C and C++ code using Simulink® Coder™.

See Also

Double-Acting Hydraulic Cylinder (Simple) | Ideal Translational Motion Sensor | Translational Damper | Translational Spring

Introduced in R2013a

Elbow

Hydraulic resistance in elbow



Library

Local Hydraulic Resistances

Description

The Elbow block represents an elbow as a local hydraulic resistance. The pressure loss is computed with the semi-empirical formula based on pressure loss coefficient, which is determined in accordance with the Crane Co. recommendations (see [1] on page 1-642, p. A-29). Two types of elbow are considered: smoothly curved (standard) and sharp-edged (miter). The block covers elbows in the 5-100 mm and 0-90 degrees range.

The block is based on the Local Resistance block. It computes the pressure loss coefficient and passes its value, as well as the critical Reynolds number value, to the Local Resistance block, which computes the pressure loss according to the formulas explained in the reference documentation for that block.

The pressure loss for turbulent flow regime is determined according to the following formula:

$$p = K \frac{\rho}{2A^2} q |q|$$

where

q	Flow rate
ρ	Pressure loss
K	Pressure loss coefficient
A	Elbow cross-sectional area
ρ	Fluid density

The flow regime is checked in the underlying Local Resistance block by comparing the Reynolds number to the specified critical Reynolds number value. For laminar flow regime, the formula for pressure loss computation is modified, as described in the reference documentation for the Local Resistance block.

The core data for the pressure loss coefficient computation is the table-specified relationship between the friction factor f_T and the internal diameter for clean commercial steel pipes, with flow in the zone of complete turbulence (see [1] on page 1-642, p. A-26). For smoothly curved, standard 90° elbows, the pressure loss coefficient is determined with the formula

$$K = 30f_T$$

For elbows with different angles, the coefficient is corrected with the relationship presented in [2] on page 1-642, Fig.4.6:

$$K_{corr} = \alpha(0.0142 - 3.703 \cdot 10^{-5}\alpha)$$

where α is the elbow angle in degrees ($0 \leq \alpha \leq 90$).

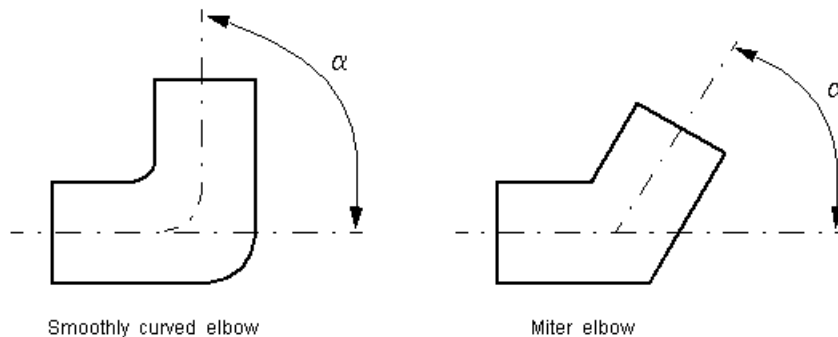

Therefore, the pressure loss coefficient for smoothly curved, standard elbows is determined with the formula

$$K_{SCE} = 30f_T \cdot \alpha(0.0142 - 3.703 \cdot 10^{-5}\alpha)$$

For sharp-edged, miter bends the pressure loss coefficient is determined according to the table provided in [1] on page 1-642, p. A-29, as a function of the elbow diameter and angle

$$K_{ME} = f(d, \alpha)$$

where $5 \leq d \leq 100$ mm and $0 \leq \alpha \leq 90$ degrees.

Connections A and B are conserving hydraulic ports associated with the block inlet and outlet, respectively.

The block positive direction is from port A to port B. This means that the flow rate is positive if fluid flows from A to B, and the pressure differential is determined as $p = p_A - p_B$.

Warning The formulas used in the Elbow block are very approximate, especially in the laminar and transient flow regions. For more accurate results, use the Local Resistance block with a table-specified $K=f(Re)$ relationship.

Basic Assumptions and Limitations

- Fluid inertia is not taken into account.
- The elbow is assumed to be made of a clean commercial steel pipe.

Parameters

Elbow type

The parameter can have one of two values: `Smoothly curved` or `Sharp-edged (miter)`. The default value is `Smoothly curved`.

Elbow internal diameter

The internal diameter of the pipe. The value must be in the range between 5 and 100 mm. The default value is 0.01 m.

Elbow angle

The angle of the bend. The value must be in the range between 0 and 90 degrees. The default value is 90 deg.

Laminar transition specification

Select how the block transitions between the laminar and turbulent regimes:

- **Pressure ratio** — The transition from laminar to turbulent regime is smooth and depends on the value of the **Laminar flow pressure ratio** parameter. This method provides better simulation robustness.
- **Reynolds number** — The transition from laminar to turbulent regime is assumed to take place when the Reynolds number reaches the value specified by the **Critical Reynolds number** parameter.

Laminar flow pressure ratio

Pressure ratio at which the flow transitions between laminar and turbulent regimes. The default value is 0.999. This parameter is visible only if the **Laminar transition specification** parameter is set to `Pressure ratio`.

Critical Reynolds number

The maximum Reynolds number for laminar flow. The value of the parameter depends on the orifice geometrical profile. You can find recommendations on the parameter value in hydraulics textbooks. The default value is 80. This parameter is visible only if the **Laminar transition specification** parameter is set to `Reynolds number`.

Restricted Parameters

When your model is in Restricted editing mode, you cannot modify the following parameter:

- **Elbow type**
- **Laminar transition specification**

All other block parameters are available for modification.

Global Parameters

Parameters determined by the type of working fluid:

- **Fluid density**
- **Fluid kinematic viscosity**

Use the Hydraulic Fluid block or the Custom Hydraulic Fluid block to specify the fluid properties.

Ports

The block has the following ports:

A

Hydraulic conserving port associated with the elbow inlet.

B

Hydraulic conserving port associated with the elbow outlet.

References

[1] *Flow of Fluids Through Valves, Fittings, and Pipe*, Crane Valves North America, Technical Paper No. 410M

[2] George R. Keller, *Hydraulic System Analysis*, Published by the Editors of Hydraulics & Pneumatics Magazine, 1970

Extended Capabilities

C/C++ Code Generation

Generate C and C++ code using Simulink® Coder™.

See Also

Gradual Area Change | Local Resistance | Pipe Bend | Sudden Area Change | T-junction

Topics

“Upgrading Simscape Fluids Models Containing Hydraulics (Isothermal) Blocks”

Introduced in R2006b

Elbow (IL)

Pipe turn in an isothermal liquid network

Library: Simscape / Fluids / Isothermal Liquid / Pipes & Fittings



Description

The Elbow (IL) block models flow in a pipe turn in an isothermal liquid network. Pressure losses due to pipe turns are calculated, but the effect of viscous friction is omitted.

Two **Elbow type** settings are available: Smoothly-curved and Sharp-edged (Miter). For a smooth pipe with a 90° bend and modeled losses due to friction, you can also use the Pipe Bend (IL) block.

Loss Coefficients

For smoothly-curved pipe segments, the loss coefficient is calculated as:

$$K = 30f_T C_{angle}.$$

C_{angle} , the angle correction factor, is calculated from Keller [2] as:

$$C_{angle} = 0.0148\theta - 3.9716 \cdot 10^{-5}\theta^2,$$

where θ is the **Bend angle** in degrees. The friction factor, f_T , is defined for clean commercial steel. The values are interpolated from tabular data based on the internal elbow diameter for f_T provided by Crane [1]:

**PIPE FRICTION DATA FOR CLEAN COMMERCIAL STEEL PIPE
WITH FLOW IN ZONE OF COMPLETE TURBULENCE**

Nominal Size	1/2"	3/4"	1"	1 1/4"	1 1/2"	2"	2 1/2, 3"	4"	5"	6"	8-10"	12-16"	18-24"
Friction Factor (f_T)	.027	.025	.023	.022	.021	.019	.018	.017	.016	.015	.014	.013	.012

The values provided by Crane are valid for diameters up to 600 mm. The friction factor for larger diameters or for wall roughness beyond this range is calculated by nearest-neighbor extrapolation.

For sharp-edged pipe segments, the loss coefficient K is calculated for the bend angle, α , according to Crane [1]:

MITRE BENDS

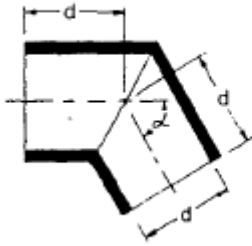

α	K
0°	$2 f_T$
15°	$4 f_T$
30°	$8 f_T$
45°	$15 f_T$
60°	$25 f_T$
75°	$40 f_T$
90°	$60 f_T$

Mass Flow Rate

Mass is conserved through the pipe segment:

$$\dot{m}_A + \dot{m}_B = 0.$$

The mass flow rate through the elbow is calculated as:

$$\dot{m} = A \sqrt{\frac{2\bar{\rho}}{K}} \frac{\Delta p}{[\Delta p^2 + \Delta p_{crit}^2]^{1/4}},$$

where:

- A is the flow area.
- $\bar{\rho}$ is the average fluid density.
- Δp is the pipe segment pressure difference, $p_A - p_B$.

The critical pressure difference, Δp_{crit} , is the pressure differential associated with the **Critical Reynolds number**, Re_{crit} , the flow regime transition point between laminar and turbulent flow:

$$\Delta p_{crit} = \frac{\bar{\rho}}{2} K \left(\frac{\nu Re_{crit}}{D} \right)^2,$$

where

- ν is the fluid kinematic viscosity.
- D is the elbow internal diameter.

Ports**Conserving****A – Liquid port**

isothermal liquid

Liquid entry or exit port to the pipe segment.

B – Liquid port

isothermal liquid

Liquid entry or exit port to the pipe segment.

Parameters

Elbow type – Bend geometry

Smoothly curved (default) | Sharp-edged (Miter)

Bend specification of the pipe segment. A sharp-edged, or mitre, bend introduces a sharp change in flow direction, such as at a pipe joint, and the flow losses are modeled by a separate set of empirical data from gradually-turning pipe segments.

Elbow internal diameter – Pipe internal diameter

0.01 m (default) | positive scalar

Internal diameter of the pipe elbow segment.

Elbow angle – Pipe curve angle

90 deg (default) | positive scalar

Angle of the swept pipe curve.

Critical Reynolds number – Upper Reynolds number limit for laminar flow

150 (default) | positive scalar

Upper Reynolds number limit for laminar flow through the pipe segment.

References

[1] Crane Co. *Flow of Fluids Through Valves, Fittings, and Pipe TP-410*. Crane Co., 1981.

[2] Keller, G. R. *Hydraulic System Analysis*. Penton, 1985.

See Also

Pipe Bend (IL) | T-Junction (IL) | Local Resistance (IL) | Area Change (IL) | Pipe (IL) | Partially Filled Pipe (IL)

Introduced in R2020a

E-NTU Heat Transfer

Detailed heat transfer model between two general fluids

Library: Simscape / Fluids / Fluid Network Interfaces / Heat Exchangers / Fundamental Components

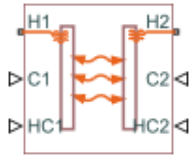

Description

The E-NTU Heat Transfer block models the heat exchange between two general fluids based on the standard Effectiveness-NTU method. The fluid thermal properties are specified explicitly through Simscape physical signals. Combine with the Heat Exchanger Interface (TL) block to model the pressure drop and temperature change between the inlet and outlet of a heat exchanger.

The block dialog box provides a choice of common heat exchanger configurations. These include concentric-pipe with parallel and counter flows, shell-and-tube with one or more shell passes, and cross-flow with mixed and unmixed flows. A generic configuration lets you model other heat exchangers based on tabular effectiveness data.

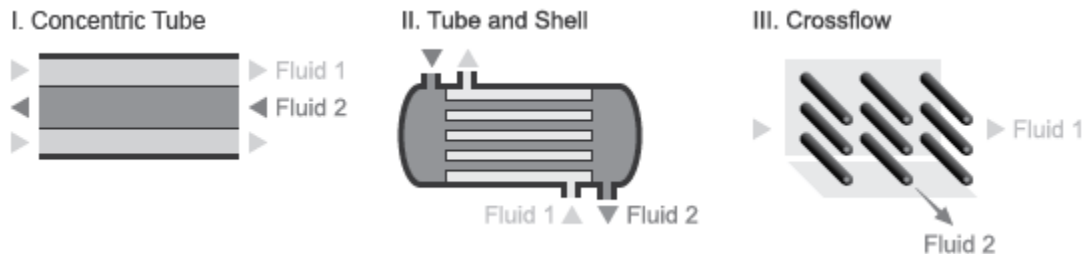

Heat Exchanger Configurations

Heat Transfer Rate

The E-NTU model defines the heat transfer rate between fluids 1 and 2 in terms of an effectiveness parameter ε :

$$Q_1 = -Q_2 = \varepsilon Q_{Max}, \quad 0 < \varepsilon < 1,$$

where:

- Q_1 and Q_2 are the heat transfer rates into fluid 1 and fluid 2.
- Q_{Max} is the maximum possible heat transfer rate between fluid 1 and fluid 2 at a given set of operating conditions.
- ε is the effectiveness parameter.

The maximum possible heat transfer rate between the two fluids is

$$Q_{Max} = C_{Min}(T_{1,In} - T_{2,In}),$$

where:

- C_{Min} is the minimum value of the thermal capacity rate:

$$C_{Min} = \min(\dot{m}_1 c_{p,1}, \dot{m}_2 c_{p,2})$$

- $T_{1,In}$ and $T_{2,In}$ are the inlet temperatures of fluid 1 and fluid 2.
- \dot{m}_1 and \dot{m}_2 are the mass flow rates of fluid 1 and fluid 2 into the heat exchanger volume through the inlet.
- $c_{p,1}$ and $c_{p,2}$ are the specific heat coefficients at constant pressure of fluid 1 and fluid 2. The **Minimum fluid-wall heat transfer coefficient** parameter in the block dialog box sets a lower bound on the allowed values of the heat transfer coefficients.

Heat Exchanger Effectiveness

The heat exchanger effectiveness calculations depend on the flow arrangement type selected in the block dialog box. For all but **Generic – effectiveness table**, the block computes the thermal exchange effectiveness through analytical expressions written in terms of the number of transfer units (NTU) and thermal capacity ratio. The number of transfer units is defined as

$$NTU = \frac{U_{Overall} A_{Heat}}{C_{Min}} = \frac{1}{C_{Min} R_{Overall}},$$

where:

- NTU is the number of transfer units.
- $U_{Overall}$ is the overall heat transfer coefficient between fluid 1 and fluid 2.
- $R_{Overall}$ is the overall thermal resistance between fluid 1 and fluid 2.
- A_{Heat} is aggregate area of the primary and secondary, or finned, heat transfer surfaces.

The thermal capacity ratio is defined as

$$C_{rel} = \frac{C_{Min}}{C_{Max}}$$

where:

- C_{rel} is the thermal capacity ratio.

The overall heat transfer coefficient and thermal resistance used in the NTU calculation are functions of the heat transfer mechanisms at work. These mechanisms include convective heat transfer between the fluids and the heat exchanger interface and conduction through the interface wall [2 on page 1-650]:

$$R_{Overall} = \frac{1}{U_{Overall} A_{Heat}} = \frac{1}{h_1 A_{Heat,1}} + R_{Foul,1} + R_{Wall} + R_{Foul,2} + \frac{1}{h_2 A_{Heat,2}},$$

where:

- h_1 and h_2 are the heat transfer coefficients between fluid 1 and the interface wall and between fluid 2 and the interface wall.

- $A_{Heat,1}$ and $A_{Heat,2}$ are the heat transfer surface areas on the fluid-1 and fluid-2 sides.
- $R_{Foul,1}$ and $R_{Foul,2}$ are the fouling resistances on the fluid-1 and fluid-2 sides.
- R_{Wall} is the interface wall thermal resistance.

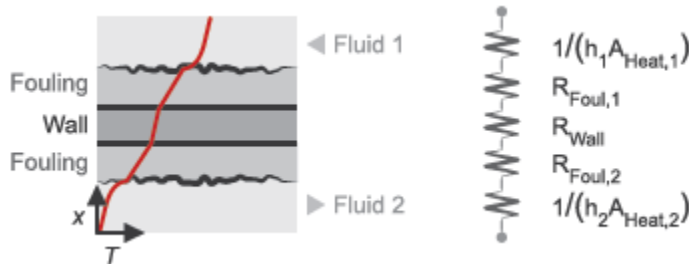

Heat Transfer From Fluid 1 to Fluid 2

The tables show some of the analytical expressions used to compute the heat exchange effectiveness [1 on page 1-650]. The parameter N refers to the number of shell passes and the parameter ε_1 to the effectiveness for a single shell pass.

Concentric Tubes	
Counter Flow	$\varepsilon = \begin{cases} \frac{1 - \exp[-NTU(1 - C_{rel})]}{1 - C_{rel}\exp[-NTU(1 - C_{rel})]}, & \text{if } C_{rel} < 1 \\ \frac{NTU}{1 + NTU}, & \text{if } C_{rel} = 1 \end{cases}$
Parallel Flow	$\varepsilon = \frac{1 - \exp[-NTU(1 + C_{rel})]}{1 + C_{rel}}$
Shell and Tube	
One shell pass and two, four, or six tube passes	$\varepsilon_1 = \frac{2}{1 + C_{rel} + \sqrt{1 + C_{rel}^2} \frac{1 + \exp(-NTU\sqrt{1 + C_{rel}^2})}{1 - \exp(-NTU\sqrt{1 + C_{rel}^2})}}$
N Shell Passes and $2N$, $4N$, or $6N$ Tube Passes	$\varepsilon = \frac{[(1 - \varepsilon_1 C_{rel}) / (1 - \varepsilon_1)]^N - 1}{[(1 - \varepsilon_1 C_{rel}) / (1 - \varepsilon_1)]^N - C_{rel}}$
Cross Flow (Single Pass)	
Both Fluids Unmixed	$\varepsilon = 1 - \exp\left(\frac{\exp(-C_{rel}NTU^{0.78}) - 1}{C_{rel}NTU^{-0.22}}\right)$
Both Fluids Mixed	$\varepsilon = \frac{1}{\frac{1}{1 - \exp(-NTU)} + \frac{C_{rel}}{1 - \exp(-C_{rel}NTU)} - \frac{1}{NTU}}$
C_{Max} mixed, C_{Min} unmixed	$\varepsilon = \frac{1}{C_{rel}}(1 - \exp(-C_{rel}(1 - \exp(-NTU))))$
C_{Max} unmixed, C_{Min} mixed	$\varepsilon = 1 - \exp\left(-\frac{1}{C_{rel}}(1 - \exp(-C_{rel}NTU))\right)$

Assumptions and Limitations

The flows are single-phase. The heat transfer is strictly one of sensible heat. The transfer is limited to interior of the exchanger, with the environment neither gaining heat from nor providing heat to the flows—the heat exchanger is an adiabatic component.

Ports

- H1 — Thermal conserving port associated with the inlet temperature of fluid 1
- H2 — Thermal conserving port associated with the inlet temperature of fluid 2
- C1 — Physical signal input port for the thermal capacity rate of fluid 1
- C2 — Physical signal input port for the thermal capacity rate of fluid 2
- HC1 — Physical signal input port for the heat transfer coefficient between fluid 1 and the interface wall
- HC2 — Physical signal input port for the heat transfer coefficient between fluid 2 and the interface wall

Parameters

Common Tab

Flow arrangement

Heat exchanger geometry. Common geometries that you can select include `Parallel` or `counter flow`, `Shell and tube`, and `Cross flow`. Select `Generic – effectiveness table` to model other heat exchanger geometries based on tabular effectiveness data.

In the `Parallel` or `counter flow` configuration, the relative flow directions of fluids 1 and 2 determine whether the heat exchanger is based on parallel or counter flows. The flow directions depend on the remainder of the Simscape Fluids model.

Number of shell passes

Number of times the flow traverses the shell before exiting.

This parameter is visible only when the **Flow arrangement** parameter is set to `Shell and tube`. The default value is 1, corresponding to a single shell pass.

Cross flow type

Fluid mixing configuration. The fluids can be mixed or unmixed. The block uses the mixing configuration to determine which empirical heat transfer correlations to use. This parameter is visible only when the **Flow arrangement** parameter is set to `Cross flow`. The default setting is `Both fluids mixed`.

Number of heat transfer units vector, NTU

M -element vector of NTU values at which to specify the effectiveness tabular data. The number of transfer units (NTU) is a dimensionless parameter defined as

$$NTU = \frac{A_s U}{C_{min}}$$

where:

- A_S is the heat transfer surface area.
- U is the overall heat transfer coefficient.
- C_{\min} is the smallest of the thermal capacity rates for the hot and cold fluids.

This parameter is visible only when the **Flow Arrangement** parameter is set to `Generic – effectiveness table`. The default vector is [0.5, 1.0, 2.0, 3.0, 4.0].

Thermal capacity ratio vector, CR

N -element vector of thermal capacity ratios at which to specify the effectiveness tabular data. The thermal capacity ratio is the fraction

$$C_r = \frac{C_{\min}}{C_{\max}},$$

where C_{\min} and C_{\max} are the minimum and maximum thermal capacity rates. This parameter is visible only when the **Flow arrangement** parameter is set to `Generic – effectiveness table`. The default vector is [0.0, 0.25, 0.5, 0.75, 1.0].

Effectiveness table, E(NTU, CR)

M -by- N matrix with the heat exchanger effectiveness values. The matrix rows correspond to the different values specified in the **Number of heat transfer units vector, NTU** parameter. The matrix columns correspond to the values specified in the **Thermal capacity ratio vector, CR** parameter.

This parameter is visible only when the **Flow arrangement** parameter is set to `Generic – effectiveness table`. The default table is a 6-by-5 matrix ranging in value from 0.30 to 0.99.

Wall thermal resistance

Thermal resistance of the interface wall separating the two heat exchanger fluids. The block uses this parameter to compute the rate of heat transfer between the fluids. The default value is 1.6×10^{-4} k/W.

Controlled Fluid 1 Tab | Controlled Fluid 2 Tab

Heat transfer surface area

Aggregate surface area for heat transfer between the cold and hot fluids. The default value is 0.01 m^2 .

Fouling factor

Empirical parameter used to quantify the increased thermal resistance due to dirt deposits on the heat transfer surface. The default value is $1 \times 10^{-4} \text{ m}^2 \cdot \text{K}/\text{W}$.

Minimum fluid-wall heat transfer coefficient

Smallest allowed value of the heat transfer coefficient. The heat transfer coefficients specified through physical signal ports HC1 and HC2 saturate at this value. The default value is $5 \text{ W}/(\text{m}^2 \cdot \text{K})$.

The block uses the heat transfer coefficient to calculate the heat transfer rate between fluids 1 and 2 as described in “Heat Transfer Rate” on page 1-646.

References

- [1] Holman, J. P. *Heat Transfer*. 9th ed. New York, NY: McGraw Hill, 2002.

[2] Shah, R. K. and D. P. Sekulic. *Fundamentals of Heat Exchanger Design*. Hoboken, NJ: John Wiley & Sons, 2003.

Extended Capabilities

C/C++ Code Generation

Generate C and C++ code using Simulink® Coder™.

See Also

Heat Exchanger Interface (TL) | Heat Exchanger Interface (G)

Introduced in R2016a

Fan (G)

Fan in gas network

Library: Simscape / Fluids / Gas / Turbomachinery



Description

The Fan (G) block represents a fan in a gas network. You can model the torque and pressure gain over the fan as a function of static pressure and flow rate or by using 1D or 2D tabulated reference pressure, shaft speed, and flow rate data.

By default, flow and pressure gain are from port **A** to port **B**. Port **C** represents the fan casing, and port **R** represents the fan shaft. You can specify the normal operating shaft direction in the **Mechanical orientation** parameter. If the shaft begins to spin in the opposite direction, the pressure difference across the fan drops to zero.

Parameterization by Nominal Pressure, Flow Rate, and Shaft Speed

When you set the **Fan parameterization** parameter to **Static pressure and flow rate at reference shaft speed**, the block uses the analytical fan affinity laws and reference pressure differential to calculate the pressure gain from port **A** to port **B**:

$$p_B - p_A = \Delta H_{ref} \rho g \left(\frac{\omega}{\omega_{ref}} \right)^2 \left(\frac{D}{D_{ref}} \right)^2,$$

where:

- Δp_{ref} is the reference pressure differential. The block uses a quadratic fit of the fan pressure differential values at the **Maximum static pressure gain at zero flow**, **Nominal static pressure gain**, and **Maximum volumetric flow rate at zero pressure** parameters.
- ω is the shaft angular velocity, $\omega_R - \omega_C$.
- ω_{ref} is the **Reference shaft speed** parameter.
- $\frac{D}{D_{ref}}$ is the **Fan diameter scale factor** parameter.

The block calculates the shaft torque from the reference mechanical power and the fan affinity laws:

$$\tau = \Phi_{ref} \frac{\omega^2}{\omega_{ref}^3} \left(\frac{D}{D_{ref}} \right)^5.$$

Where Φ_{ref} is the proportion of the pressure gain to the fan efficiency:

$$\Phi_{ref} = \frac{q_{ref} \Delta p_{ref}}{\eta_{ref}}.$$

When you set the **Shaft power specification** parameter to **Fan efficiency**, the block uses a quadratic fit of efficiency between the fan peak performance, η_{nom} , and 0. η_{nom} is equivalent to the **Nominal efficiency** parameter, which the block interprets as the peak efficiency. If you set the **Shaft power specification** parameter to **Brake power**, the block derives the nominal fan efficiency from the nominal brake power, Φ_{nom} , at peak or nominal conditions:

$$\eta_{nom} = \frac{q_{nom}\Delta p_{nom}}{\Phi_{nom}}.$$

The block assumes the efficiency is zero when there is no flow or when the flow reaches the maximum volumetric flow rate at zero pressure. The block uses the current flow q to compute the reference flow rate as:

$$q_{ref} = q \frac{\omega_{ref} \left(\frac{D_{ref}}{D}\right)^3}{\omega}.$$

1-D Tabulated Data Parameterization: Pressure as a Function of Flow Rate at Reference Shaft Speed

When you set the **Fan parameterization** parameter to **1D tabulated data - static pressure vs. flow rate at reference shaft speed**, you can model fan performance as a function of volumetric flow rate. The block interpolates the pressure gain from port **A** to port **B** from the **1-D Static pressure gain vector** parameter, $\Delta p_{ref}(q_{ref})$:

$$p_B - p_A = \Delta p_{ref}(q_{ref}) \left(\frac{\rho}{\rho_{ref}}\right) \left(\frac{\omega}{\omega_{ref}}\right)^2 \left(\frac{D}{D_{ref}}\right)^2.$$

Here, ρ is the moist air density, and ρ_{ref} is the reference density, which is equivalent to the **Reference density** parameter. The block calculates the shaft torque from the reference mechanical power and the fan affinity laws:

$$\tau = \Phi_{ref}(q_{ref}) \frac{\omega^2}{\omega_{ref}^3} \left(\frac{\rho}{\rho_{ref}}\right) \left(\frac{D}{D_{ref}}\right)^5,$$

where ρ_{ref} is the **Reference density**.

The block uses the current flow q to compute the reference flow rate:

$$q_{ref} = q \frac{\omega_{ref} \left(\frac{D_{ref}}{D}\right)^3}{\omega}.$$

When the simulation is outside of the normal fan operating conditions, the block linearly extrapolates the reference pressure and extrapolates the reference torque to its nearest neighbor.

2-D Tabulated Data Parameterization: Pressure as a Function of Shaft Speed and Flow Rate

When you set the **Fan parameterization** parameter to **2D tabulated data - static pressure vs. shaft speed and flow rate**, you can model fan performance as a 2-D function of volumetric flow rate and angular velocity. The block interpolates the pressure gain from port **A** to port **B** from the **2-D Static pressure gain table, dp(w,q)** parameter. The block defines the reference pressure gain, $\Delta p_{ref}(q_{ref}, \omega)$, as

$$p_B - p_A = \Delta p_{ref}(q_{ref}, \omega) \left(\frac{\rho}{\rho_{ref}}\right) \left(\frac{D}{D_{ref}}\right)^2.$$

The block calculates shaft torque from the reference mechanical power and the fan affinity laws:

$$\tau = \frac{\Phi_{ref}(\Delta p_{ref}, \omega)}{\omega} \left(\frac{\rho}{\rho_{ref}} \right) \left(\frac{D}{D_{ref}} \right)^5,$$

where the reference mechanical power is a function of the reference flow rate and the current shaft speed.

The block uses the current flow q to compute the reference flow rate:

$$q_{ref} = q \left(\frac{D_{ref}}{D} \right)^3.$$

When the simulation is outside of the normal fan operating conditions, the block linearly extrapolates the reference pressure and extrapolates the reference torque to its nearest neighbor.

2-D Tabulated Data Parameterization: Flow Rate as a Function of Shaft Speed and Pressure

When you set the **Fan parameterization** parameter to 2D tabulated data - flow rate vs. shaft speed and static pressure, you can model the flow rate through the fan as a 2-D function of pressure and angular velocity. The volumetric flow rate is interpolated from the 2-D **Volumetric flow rate table, $q(\mathbf{w}, \mathbf{dp})$** parameter, q_{ref} . The reference flow rate is a function of the reference pressure gain, Δp_{ref} , and the current shaft speed, ω :

$$q = q_{ref}(\Delta p_{ref}, \omega) \left(\frac{D}{D_{ref}} \right)^3,$$

where the reference pressure gain derives from the pressure differential over the fan:

$$\Delta p_{ref} = (p_B - p_A) \left(\frac{\rho_{ref}}{\rho} \right) \left(\frac{D_{ref}}{D} \right)^2.$$

The shaft torque derives from the reference mechanical power and the fan affinity laws:

$$\tau = \frac{\Phi_{ref}(\Delta p_{ref}, \omega)}{\omega} \left(\frac{\rho}{\rho_{ref}} \right) \left(\frac{D}{D_{ref}} \right)^5,$$

where the reference mechanical power is a function of the reference flow rate and the current shaft speed.

When the simulation is outside of the normal fan operating conditions, the block linearly extrapolates the reference pressure and extrapolates the reference torque to its nearest neighbor.

Power and Efficiency

You can specify shaft power as either fan efficiency or brake power.

The block calculates efficiency as

$$\eta = \frac{\Phi_{fluid}}{\Phi_{brake}},$$

where the *brake power*, or mechanical power measured at the shaft, is

$$\Phi_{brake} = \tau\omega.$$

The block calculates fluid power as

$$\Phi_{fluid} = q(p_B - p_A).$$

The block calculates torque as

$$\tau = \frac{\Phi_{brake}}{\omega}.$$

Visualizing the Fan Curve

You can check the parameterized fan performance by plotting the pressure, power, efficiency, and torque as a function of the flow. To generate a plot of the current pump settings, right-click on the block and select **Fluids > Plot Fan Characteristics**. If you change settings or data, click **Apply** on the block parameters and click **Reload Data** on the pump curve figure.

The default block parameterization results in these plots:

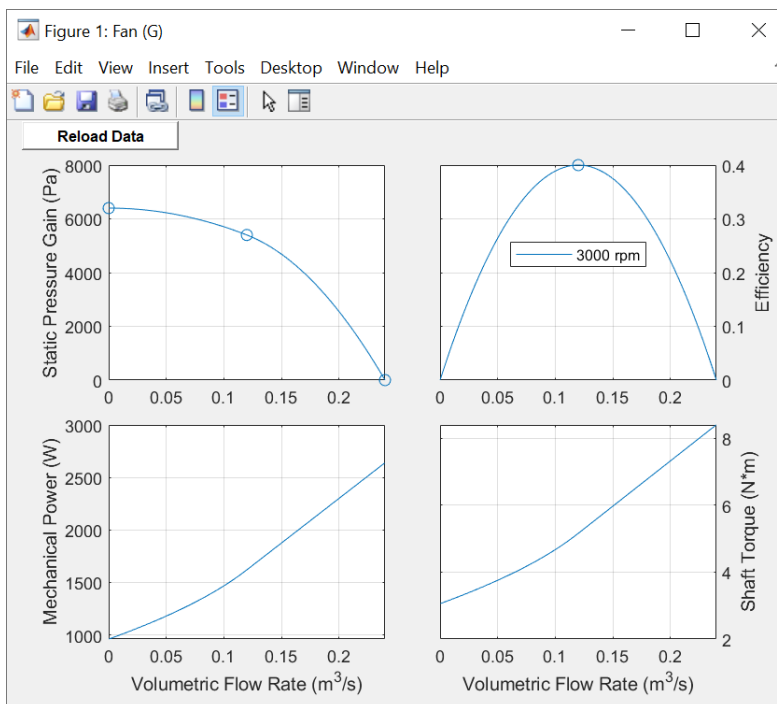

Assumptions and Limitations

- Reverse flow or a pressure drop over the fan is not normal operation, and the simulation results in these situations may not be accurate.
- The block assumes that the fan is quasi-steady.
- The block simulates fan performance in terms of static pressure rise, and not total fan pressure.

Ports

Conserving

A – Fluid entry

gas

Gas conserving port associated with the fluid.

B – Fluid exit

gas

Gas conserving port associated with the fluid.

R – Shaft

mechanical rotational

Mechanical rotational conserving port associated with the shaft.

C – Casing

mechanical rotational

Mechanical rotational conserving port associated with the casing.

Parameters

Fan parameterization – Fan performance model

Static pressure and flow rate at reference shaft speed (default) | 1D tabulated data - static pressure vs. flow rate at reference shaft speed | 2D tabulated data - static pressure vs. shaft speed and flow rate | 2D tabulated data - flow rate vs. shaft speed and static pressure

Fan performance model.

- Static pressure and flow rate at reference shaft speed - Specify fan performance based on typical, nominal, or rated pressure gain and volumetric flow rate.
- 1D tabulated data – static pressure vs flow rate at reference shaft speed - Specify fan performance based on interpolation of pressure gain data as a function of volumetric flow rate.
- 2D tabulated data – static pressure vs shaft speed and flow rate - Specify fan performance based on interpolation of pressure gain data as a function of shaft speed and volumetric flow rate.
- 2D tabulated data – flow rate vs shaft speed and static pressure - Specify fan performance based on interpolation of volumetric flow rate data as a function of shaft speed and pressure gain.

Shaft power specification – Power definition

Fan efficiency (default) | Brake power

Fan power specification.

- Fan efficiency - Derive the mechanical power from the fan efficiency.

- **Mechanical power** – Specify the mechanical power directly.

Nominal volumetric flow rate — Flow rate at reference shaft speed

0.12 m³/s (default) | positive scalar

Volumetric flow rate through the fan at the reference shaft speed under nominal, typical, or rated operating conditions.

Dependencies

To enable this parameter, set **Fan parameterization** to Static pressure and flow rate at reference shaft speed.

Nominal static pressure gain — Pressure gain at reference shaft speed

5400 Pa (default) | positive scalar

Pressure increase from port **A** to port **B** at the reference shaft speed under nominal, typical, or rated operating conditions.

Dependencies

To enable this parameter, set **Fan parameterization** to Static pressure and flow rate at reference shaft speed.

Nominal efficiency — Efficiency at reference shaft speed

0.40 (default) | positive scalar

Efficiency of converting the shaft power to fluid power at the reference shaft speed under nominal, typical, or rated operating conditions.

Dependencies

To enable this parameter, set:

- **Fan parameterization** to Static pressure and flow rate at reference shaft speed.
- **Shaft power specification** to Fan efficiency.

Nominal mechanical power — Power at nominal efficiency

1620 W (default) | positive scalar

Mechanical power driving moist air flow at the reference shaft speed under nominal, typical, or rated operating conditions.

Dependencies

To enable this parameter, set:

- **Fan parameterization** to Static pressure and flow rate at reference shaft speed.
- **Shaft power specification** to Brake power.

Maximum static pressure gain at zero flow — Maximum pressure at reference shaft speed

6400 Pa (default) | positive scalar

Pressure increase from port **A** to port **B** at the reference shaft speed when there is no flow through the fan.

Dependencies

To enable this parameter, set **Fan parameterization** to Static pressure and flow rate at reference shaft speed.

Maximum volumetric flow rate at zero pressure – Maximum flow rate at reference shaft speed

0.24 m³/s (default) | positive scalar

Free-delivery volumetric flow rate at the reference shaft speed and constant pressure.

Dependencies

To enable this parameter, set **Fan parameterization** to Static pressure and flow rate at reference shaft speed.

Reference shaft speed – Fan curve reference speed

3000 rpm (default) | positive scalar

Reference shaft angular velocity corresponding to the fan characteristic curve data.

Dependencies

To enable this parameter, set **Fan parameterization** to Static pressure and flow rate at reference shaft speed.

Volumetric flow rate vector – Fan curve flow rate vector

[.0278, .0556, .0833, .111, .139, .167] m³/s (default) | vector

Vector of volumetric flow rate grid points for the 1-D interpolation of the fan characteristic curve.

Dependencies

To enable this parameter, set **Fan parameterization** to 1D tabulated data - static pressure vs. flow rate at reference shaft speed.

Static pressure gain vector – Pressure gain for given volumetric flow rate

[6410, 6375, 6018, 5366, 4501, 3609] Pa (default) | vector

Vector of pressure gain data points. Each element in the vector corresponds to an element in the **Volumetric flow rate vector** parameter. The pressure gain is the increase in pressure from port **A** to port **B** at the reference shaft speed.

Dependencies

To enable this parameter, set **Fan parameterization** to 1D tabulated data - static pressure vs. flow rate at reference shaft speed.

Efficiency vector – Efficiency for given volumetric flow rate

[.257, .394, .453, .47, .459, .415] (default) | vector

Vector of fan efficiency data points. Each element in the vector corresponds to an element in the **Volumetric flow rate vector** parameter. The efficiency is the ratio of fluid power to shaft mechanical power at the reference shaft speed.

Dependencies

To enable this parameter, set **Fan parameterization** to 1D tabulated data - static pressure vs. flow rate at reference shaft speed and **Shaft power specification** to Fan efficiency.

Mechanical power vector — Power for parameterization of torque

[693, 900, 1107, 1267, 1363, 1452] W (default) | 1-by- n vector

Vector of shaft mechanical power data points. Each element in the vector corresponds to an element in the **Volumetric flow rate vector** parameter. The mechanical power is the power that drives the fan at the reference shaft speed.

Dependencies

To enable this parameter, set **Fan parameterization** to 1D tabulated data - static pressure vs. flow rate at reference shaft speed and **Shaft power specification** to Brake power.

Reference density — Density associated with fan curve data

1.2 kg/m³ (default) | positive scalar

Moist air density for a given characteristic fan curve.

Shaft speed vector, w — Shaft angular velocity for given

[2400; 3000; 3600] rpm (default) | vector

Vector of shaft angular velocity grid points for the 2-D interpolation of the fan characteristic curves.

Dependencies

To enable this parameter, set **Fan parameterization** to 2D tabulated data - static pressure vs. shaft speed and flow rate.

Volumetric flow rate vector, q — Flow rate for parameterization of pressure gain

[.0278, .0556, .0833, .111, .139, .167] m³/s (default) | 1-by- n vector

Vector of volumetric flow rate grid points for the 2-D interpolation of the fan characteristic curves.

Dependencies

To enable this parameter, set **Fan parameterization** to 2D tabulated data - static pressure vs. shaft speed and flow rate.

Static pressure gain table, $dp(w,q)$ — Pressure for parameterization of pressure

[4111, 4010, 3551, 2881, 2167, 1453; 6410, 6375, 6018, 5366, 4501, 3609; 9217, 9285, 9022, 8428, 7552, 6482] Pa (default) | M -by- N matrix

M -by- N matrix of pressure gain data points for the 2-D interpolation of the pressure gain. The pressure gain is the increase in pressure from port **A** to port **B**. M and N are the sizes of the corresponding vectors:

- M is the number of elements in the **Shaft speed vector, w** parameter. The elements in the first column must be in strictly ascending order.
- N is the number of elements in the **Volumetric flow rate vector, q** parameter.

Dependencies

To enable this parameter, set **Fan parameterization** to 2D tabulated data - static pressure vs. shaft speed and flow rate.

Efficiency table, eta(w,q) — Efficiency for parameterization of torque

[.3, .434, .468, .459, .4, .3; .257, .394, .453, .47, .459, .415; .225, .359, .434, .461, .47, .459] 1 (default) | *M*-by-*N* matrix

M-by-*N* matrix of efficiency data points for the 2-D interpolation of torque. The efficiency is the ratio of fluid power to shaft mechanical power. *M* and *N* are the sizes of the corresponding vectors:

- *M* is the number of elements in the **Shaft speed vector, w** parameter.
- *N* is the number of elements in the **Volumetric flow rate vector, q** parameter.

Dependencies

To enable this parameter, set **Fan parameterization** to 2D tabulated data - static pressure vs. shaft speed and flow rate and **Shaft power specification** to Fan efficiency.

Mechanical power table, W(w,q) — Mechanical power for parameterization of torque

[381, 514, 632, 697, 753, 809; 693, 900, 1107, 1267, 1363, 1452; 1139, 1438, 1732, 2029, 2233, 2358] W (default) | *M*-by-*N* matrix

M-by-*N* table of mechanical power data points for the 2-D interpolation of torque. The mechanical power is the power that drives the fan. *M* and *N* are the sizes of the corresponding vectors:

- *M* is the number of elements in the **Shaft speed vector, w** parameter. Elements in the first column must be in strictly ascending order.
- *N* is the number of elements in the **Volumetric flow rate vector, q** parameter.

Dependencies

To enable this parameter, set **Fan parameterization** to 2D tabulated data - static pressure vs. shaft speed and flow rate and **Shaft power specification** to Brake power.

Shaft speed vector, w — Shaft speed for parameterization of flow rate

[2990; 3450; 3867] rpm (default) | *M*-by-1 vector

Vector of shaft angular velocity grid points for the 2-D interpolation of the fan characteristic curves.

Dependencies

To enable this parameter, set **Fan parameterization** to 2D tabulated data - flow rate vs. shaft speed and static pressure.

Static pressure gain vector, dp — Pressure for parameterization of flow rate

[31, 62, 93, 124] Pa (default) | 1-by-*N* vector

Vector of pressure gain grid points for the 2-D interpolation of the fan characteristic curves.

Dependencies

To enable this parameter, set **Fan parameterization** to 2D tabulated data - flow rate vs. shaft speed and static pressure.

Volumetric flow rate table, $q(w, dp)$ – Flow rate for parameterization of flow rate

[.802, .759, .703, .611; .936, .902, .862, .81; 1.056, 1.027, .994, .956]
 m^3/s (default) | M -by- N matrix

M -by- N matrix of volumetric flow rate data points for the 2-D interpolation of volumetric flow rate. M and N are the sizes of the corresponding vectors:

- M is the number of elements in the **Shaft speed vector, w** parameter.
- N is the number of elements in the **Static pressure gain vector, Dp** parameter.

Dependencies

To enable this parameter, set **Fan parameterization** to 2D tabulated data - flow rate vs. shaft speed and static pressure.

Efficiency table, $\eta(w, dp)$ – Efficiency for parameterization of torque

[.088, .162, .22, .261; .068, .128, .18, .222; .055, .105, .148, .188] (default)
 | M -by- N matrix

M -by- N matrix of efficiency data points for the 2-D interpolation of torque. The efficiency is the ratio of fluid power to shaft mechanical power. M and N are the sizes of the corresponding vectors:

- M is the number of elements in the **Shaft speed vector, w** parameter.
- N is the number of elements in the **Static pressure gain vector, Dp** parameter.

Dependencies

To enable this parameter, set **Fan parameterization** to 2D tabulated data - flow rate vs. shaft speed and static pressure and **Shaft power specification** to Fan efficiency.

Mechanical power table, $W(w, dp)$ – Mechanical power for parameterization of torque

[283, 290, 297, 290; 427, 437, 445, 452; 595, 606, 625, 631] W (default) | M -by- N matrix

M -by- N matrix of mechanical power data points for the 2-D interpolation of torque. The mechanical power is the power that drives the fan. M and N are the sizes of the corresponding vectors:

- M is the number of elements in the **Shaft speed vector, w** parameter. The elements in the first column must be in strictly ascending order.
- N is the number of elements in the **Static pressure gain vector, Dp** parameter.

Dependencies

To enable this parameter, set **Fan parameterization** to 2D tabulated data - flow rate vs. shaft speed and static pressure and **Shaft power specification** to Brake power.

Fan diameter scale factor – Model-to-reference scale factor

1 (default) | positive scalar

Geometric scale factor to increase or decrease the size of the simulated fan from the given fan parameterization. The scaling may not be accurate for scale factors much larger or much smaller than 1.

Mechanical orientation — Rotational orientation

Positive angular velocity of port R relative to port C corresponds to normal fan operation (default) | Negative angular velocity of port R relative to port C corresponds to normal fan operation

Normal operating shaft direction. By default, flow and pressure gain are from port **A** to port **B**.

Inlet flow area (port A) — Port A area

0.01 m² (default) | positive scalar

Cross-sectional area of the moist air flow at the fan inlet.

Outlet flow area (port B) — Port B area

0.01 m² (default) | positive scalar

Cross-sectional area of the moist air flow at the fan outlet.

Compatibility Considerations**2-D Tabulated Data Parameterization: Flow Rate as a Function of Shaft Speed and Pressure Ratio**

Not recommended starting in R2021b

In R2021b, the block no longer supports the 2-D Tabulated Data Parameterization: Flow Rate as a Function of Shaft Speed and Pressure Ratio parameterization. In R2021b and later, if you open models created in a prior release that include the Fan (G) block, Simscape Fluids replaces the block with the Fan (MA) - Legacy block. This block supports the 2-D Tabulated Data Parameterization: Flow Rate as a Function of Shaft Speed and Pressure Ratio setting.

You can preserve the functionality of a model using this parameterization by setting **Fan parameterization** to 2D tabulated data - flow rate vs. shaft speed and static pressure¹ and converting the ratios to absolute values. An example script that performs this conversion takes in the legacy parameters `omega_DpMax_TLU`, `DpMax_TLU`, `omega_flow_TLU`, `Dp_DpMax_TLU`, `flow_rate_TLU`, and `eta_flow_TLU` and returns the converted parameters `omega_g_TLU`, `pressure_g_TLU`, `pressure_g_TLU`, and `eta_g_TLU`:

```
% Shaft speed vector for maximum pressure rise vector
omega_DpMax_TLU = [1800, 2400, 3000];

% Maximum pressure rise vector
DpMax_TLU       = [400, 1200, 2000];

% Shaft speed vector, omega
omega_flow_TLU  = [1800, 2400, 3000];

% Static pressure rise ratio vector, Dp/DpMax
Dp_DpMax_TLU   = linspace(0, 1, 4);

% Flow rate table, q(omega,Dp/DpMax)
flow_rate_TLU  = [
    0.33    0.26    0.18    0.07
```

1. Prior to R2021b, this setting was called 2D tabulated data - flow rate and total efficiency vs. angular speed and static pressure.

```

    1.20    0.91    0.64    0.26
    1.84    1.61    1.13    0.46];

% Total efficiency table, Eta(omega,Dp/DpMax)
eta_flow_TLU = [
    0.22    0.25    0.27    0.28
    0.48    0.52    0.55    0.53
    0.42    0.45    0.49    0.44];

% Create interpolants of the tables
DpMax_TLU_interp = griddedInterpolant(omega_DpMax_TLU, DpMax_TLU, ...
    'linear', 'linear');

flow_rate_TLU_interp = griddedInterpolant({omega_flow_TLU, Dp_DpMax_TLU}, flow_rate_TLU, ...
    'linear', 'linear');

eta_flow_TLU_interp = griddedInterpolant({omega_flow_TLU, Dp_DpMax_TLU}, eta_flow_TLU, ...
    'linear', 'nearest');

% Maximum pressure rise
DpMax = DpMax_TLU_interp(max(omega_flow_TLU, omega_DpMax_TLU(1)));

% Shaft speed vector, w
omega_q_TLU = omega_flow_TLU;

% Static pressure gain vector, Dp
pressure_q_TLU = unique(DpMax(:)*Dp_DpMax_TLU(:)');

% Interpolation query points as full grid arrays
omega_grid = omega_q_TLU(:)*ones(1, length(pressure_q_TLU));

Dp_DpMax_grid = pressure_q_TLU(:)' ./ DpMax(:);

% Volumetric flow rate table, q(w,Dp)
flow_rate_q_TLU = flow_rate_TLU_interp(omega_grid, Dp_DpMax_grid);

flow_rate_q_TLU = max(flow_rate_q_TLU, 1e-4*flow_rate_TLU(1,1)); % keep it > 0

% Efficiency table, eta(w,Dp)
eta_q_TLU = eta_flow_TLU_interp(omega_grid, Dp_DpMax_grid);

```

Extended Capabilities

C/C++ Code Generation

Generate C and C++ code using Simulink® Coder™.

See Also

Compressor (G) | Turbine (G)

Introduced in R2018b

Fixed Orifice

Hydraulic orifice with constant cross-sectional area



Library

Orifices

Description

The Fixed Orifice block models a sharp-edged constant-area orifice, flow rate through which is proportional to the pressure differential across the orifice. The flow rate is determined according to the following equations:

$$q = C_D \cdot A \sqrt{\frac{2}{\rho}} \cdot \frac{p}{(p^2 + p_{cr}^2)^{1/4}}$$

$$\Delta p = p_A - p_B,$$

where

q	Flow rate
p	Pressure differential
p_A, p_B	Gauge pressures at the block terminals
C_D	Flow discharge coefficient
A	Orifice passage area
ρ	Fluid density
p_{cr}	Minimum pressure for turbulent flow

The minimum pressure for turbulent flow, p_{cr} , is calculated according to the laminar transition specification method:

- By pressure ratio — The transition from laminar to turbulent regime is defined by the following equations:

$$p_{cr} = (p_{avg} + p_{atm})(1 - B_{lam})$$

$$p_{avg} = (p_A + p_B)/2$$

where

p_{avg}	Average pressure between the block terminals
p_{atm}	Atmospheric pressure, 101325 Pa

B_{lam}	Pressure ratio at the transition between laminar and turbulent regimes (Laminar flow pressure ratio parameter value)
------------------	--

- By Reynolds number — The transition from laminar to turbulent regime is defined by the following equations:

$$p_{cr} = \frac{\rho}{2} \left(\frac{Re_{cr} \cdot \nu}{C_D \cdot D_H} \right)^2$$

$$D_H = \sqrt{\frac{4A}{\pi}}$$

where

D_H	Orifice hydraulic diameter
ν	Fluid kinematic viscosity
Re_{cr}	Critical Reynolds number (Critical Reynolds number parameter value)

The block positive direction is from port A to port B. This means that the flow rate is positive if it flows from A to B, and the pressure differential is determined as $\Delta p = p_A - p_B$.

Variables

Use the **Variables** tab to set the priority and initial target values for the block variables prior to simulation. For more information, see “Set Priority and Initial Target for Block Variables”.

Basic Assumptions and Limitations

- Fluid inertia is not taken into account.

Parameters

Orifice area

Orifice passage area. The default value is $1e-4 \text{ m}^2$.

Flow discharge coefficient

Semi-empirical parameter for orifice capacity characterization. Its value depends on the geometrical properties of the orifice, and usually is provided in textbooks or manufacturer data sheets. The default value is 0.7 .

Laminar transition specification

Select how the block transitions between the laminar and turbulent regimes:

- Pressure ratio** — The transition from laminar to turbulent regime is smooth and depends on the value of the **Laminar flow pressure ratio** parameter. This method provides better simulation robustness.
- Reynolds number** — The transition from laminar to turbulent regime is assumed to take place when the Reynolds number reaches the value specified by the **Critical Reynolds number** parameter.

Laminar flow pressure ratio

Pressure ratio at which the flow transitions between laminar and turbulent regimes. The default value is 0.999. This parameter is visible only if the **Laminar transition specification** parameter is set to Pressure ratio.

Critical Reynolds number

The maximum Reynolds number for laminar flow. The value of the parameter depends on the orifice geometrical profile. You can find recommendations on the parameter value in hydraulics textbooks. The default value is 12, which corresponds to a round orifice in thin material with sharp edges. This parameter is visible only if the **Laminar transition specification** parameter is set to Reynolds number.

Global Parameters

Parameters determined by the type of working fluid:

- **Fluid density**
- **Fluid kinematic viscosity**

Use the Hydraulic Fluid block or the Custom Hydraulic Fluid block to specify the fluid properties.

Ports

The block has the following ports:

A

Hydraulic conserving port associated with the orifice inlet.

B

Hydraulic conserving port associated with the orifice outlet.

Extended Capabilities**C/C++ Code Generation**

Generate C and C++ code using Simulink® Coder™.

See Also

Annular Orifice | Constant Area Hydraulic Orifice | Fixed Orifice Empirical | Fixed Orifice with Fluid Inertia | Orifice with Variable Area Round Holes | Orifice with Variable Area Slot | Variable Area Hydraulic Orifice | Variable Orifice

Topics

“Upgrading Simscape Fluids Models Containing Hydraulics (Isothermal) Blocks”

Introduced in R2006a

Fixed Orifice Empirical

Fixed hydraulic orifice based on empirical data



Library

Orifices

Description

The Fixed Orifice Empirical block models a fixed orifice in hydraulic systems with data obtained from experimental testing. The data required for characterization is the set of pressure differentials across the orifice, together with associated flow rates determined for a particular fluid and temperature.

The flow rate through the orifice is determined with the table lookup block from the set of experimental measurements

$$q = f(p)$$

where

q	Volumetric flow rate
p	Pressure differential

You can select from two interpolation and two extrapolation methods.

Note Extrapolation could result in large errors if the operating point deviates significantly from the area of experiments.

The block positive direction is from port A to port B. This means that the flow rate is positive if it flows from A to B, and the pressure differential is determined as $\Delta p = p_A - p_B$.

Parameters

Tabulated pressure differentials

Specify the pressure differential vector as a one-dimensional array. The vector contains values of pressure differentials obtained during experimental characterization of the orifice. The vector must be strictly increasing. The values can be nonuniformly spaced. The minimum number of values depends on the interpolation method: you must provide at least two values for linear interpolation, at least three values for smooth interpolation. The default values, in bar, are [-40.0, -30.0, -20.0, -10.0, -5.0, 0.0, 5.0, 10.0, 20.0, 30.0, 40.0].

Tabulated flow rates

Specify the vector of flow rates through the orifice, corresponding to these pressure differentials, as a one-dimensional array. The vector must be of the same size as the **Tabulated pressure**

differentials vector. The default values, in m^3/s , are [-0.0024436 -0.0021248 -0.0016852 -0.0012248 -8.4476e-4 0 8.5333e-4 0.0012068 0.0017067 0.0020902 0.0024136].

Interpolation method

Select one of the following interpolation methods for approximating the output value when the input value is between two consecutive grid points:

- **Linear** — Select this option to get the best performance.
- **Smooth** — Select this option to produce a continuous curve with continuous first-order derivatives.

For more information on interpolation algorithms, see the PS Lookup Table (1D) block reference page.

Extrapolation method

Use extrapolation with extreme caution, because moving beyond the measurement limits could result in large errors. Select one of the following extrapolation methods for determining the output value when the input value is outside the range specified in the argument list:

- **Linear** — Select this option to produce a curve with continuous first-order derivatives in the extrapolation region and at the boundary with the interpolation region.
- **Nearest** — Select this option to produce an extrapolation that does not go above the highest point in the data or below the lowest point in the data.

For more information on extrapolation algorithms, see the PS Lookup Table (1D) block reference page.

Ports

The block has the following ports:

A

Hydraulic conserving port associated with the orifice inlet.

B

Hydraulic conserving port associated with the orifice outlet.

Extended Capabilities

C/C++ Code Generation

Generate C and C++ code using Simulink® Coder™.

See Also

Fixed Orifice | Fixed Orifice with Fluid Inertia

Topics

“Upgrading Simscape Fluids Models Containing Hydraulics (Isothermal) Blocks”

Introduced in R2012b

Fixed Orifice with Fluid Inertia

Fixed hydraulic orifice accounting for flow inertia



Library

Orifices

Description

The Fixed Orifice with Fluid Inertia block models a hydraulic fixed orifice and accounts for the fluid inertia, in addition to the static pressure loss.

Fluid inertia plays a noticeable role in orifices with a large ratio of orifice length to the orifice hydraulic diameter (L / D_H) and in sharp-edged short orifices when the rate of change of flow rate (fluid acceleration) is relatively large.

The orifice is based on the following equations:

$$q = C_D \cdot A \sqrt{\frac{2}{\rho}} \cdot \frac{p_r}{(p_r^2 + p_{cr}^2)^{1/4}}$$

$$p = p_{in} + p_r$$

$$p_{in} = \rho \frac{L}{A} \frac{dq}{dt}$$

where

q	Volumetric flow rate
p	Total pressure differential
p_{in}	Inertial pressure drop
p_r	Resistive pressure drop
C_D	Flow discharge coefficient
A	Orifice passage area
L	Orifice length
ρ	Fluid density
p_{cr}	Minimum pressure for turbulent flow

The minimum pressure for turbulent flow, p_{cr} , is calculated according to the laminar transition specification method:

- By pressure ratio — The transition from laminar to turbulent regime is defined by the following equations:

$$p_{cr} = (p_{avg} + p_{atm})(1 - B_{lam})$$

$$p_{avg} = (p_A + p_B)/2$$

where

p_{avg}	Average pressure between the block terminals
p_{atm}	Atmospheric pressure, 101325 Pa
B_{lam}	Pressure ratio at the transition between laminar and turbulent regimes (Laminar flow pressure ratio parameter value)

- By Reynolds number — The transition from laminar to turbulent regime is defined by the following equations:

$$p_{cr} = \frac{\rho}{2} \left(\frac{Re_{cr} \cdot \nu}{C_D \cdot D_H} \right)^2$$

$$D_H = \sqrt{\frac{4A}{\pi}}$$

where

D_H	Orifice hydraulic diameter
ν	Fluid kinematic viscosity
Re_{cr}	Critical Reynolds number (Critical Reynolds number parameter value)

Connections A and B are conserving hydraulic ports associated with the orifice inlet and outlet, respectively. The block positive direction is from port A to port B. This means that the flow rate is positive if it flows from A to B, and the pressure differential is determined as $\Delta p = p_A - p_B$.

Parameters

Orifice area

Cross-sectional area of the orifice. The default value is $1e-4 \text{ m}^2$.

Orifice length

Total length of the orifice. Generally, increase the geometrical length of the orifice up to $2 \cdot 0.8 \cdot D_H$ (where D_H is the orifice hydraulic diameter) to take into account the added volumes of fluid on both sides of the orifice. The default value is 0.01 m .

Flow discharge coefficient

Semi-empirical parameter for orifice capacity characterization. The coefficient affects the resistive pressure drop in the orifice. The default value is 0.6 .

Laminar transition specification

Select how the block transitions between the laminar and turbulent regimes:

- **Pressure ratio** — The transition from laminar to turbulent regime is smooth and depends on the value of the **Laminar flow pressure ratio** parameter. This method provides better simulation robustness.

- **Reynolds number** — The transition from laminar to turbulent regime is assumed to take place when the Reynolds number reaches the value specified by the **Critical Reynolds number** parameter.

Laminar flow pressure ratio

Pressure ratio at which the flow transitions between laminar and turbulent regimes. The default value is 0.999. This parameter is visible only if the **Laminar transition specification** parameter is set to **Pressure ratio**.

Critical Reynolds number

The maximum Reynolds number for laminar flow. The value of the parameter depends on the orifice geometrical profile. You can find recommendations on the parameter value in hydraulics textbooks. The default value is 10. This parameter is visible only if the **Laminar transition specification** parameter is set to **Reynolds number**.

Initial flow rate

Flow rate through the orifice at the start of simulation. This parameter specifies the initial condition for use in computing the block's state at the beginning of a simulation run. For more information, see "Initial Conditions Computation". The default value is 0.

Global Parameters

Parameters determined by the type of working fluid:

- **Fluid density**
- **Fluid kinematic viscosity**

Use the Hydraulic Fluid block or the Custom Hydraulic Fluid block to specify the fluid properties.

Ports

The block has the following ports:

A

Hydraulic conserving port associated with the orifice inlet.

B

Hydraulic conserving port associated with the orifice outlet.

See Also

Fixed Orifice | Fixed Orifice Empirical

Topics

"Upgrading Simscape Fluids Models Containing Hydraulics (Isothermal) Blocks"

Introduced in R2013a

Fixed-Displacement Motor

Hydraulic-to-mechanical power conversion device

Library: Simscape / Fluids / Hydraulics (Isothermal) / Pumps and Motors



Description

The Fixed-Displacement Motor block represents a device that extracts power from a hydraulic (isothermal liquid) network and delivers it to a mechanical rotational network. The motor displacement is fixed at a constant value that you specify through the **Displacement** parameter.

Ports **A** and **B** represent the motor inlet and outlet, respectively. Port **S** represents the motor drive shaft. During normal operation, the angular velocity at port **S** is positive if the pressure drop from port **A** to port **B** is positive also. This operation mode is referred to here as forward motor.

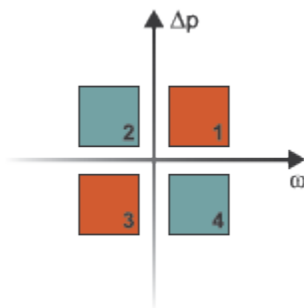

Operation Modes

A total of four operation modes are possible. The working mode depends on the pressure drop from port **A** to port **B** (Δp) and on the angular velocity at port **S** (ω). The “Operation Modes” on page 1-672 figure maps the modes to the octants of a Δp - ω - D chart. The modes are labeled 1-4:

- Mode **1**: forward motor — A positive pressure drop generates a positive shaft angular velocity.
- Mode **2**: reverse pump — A negative shaft angular velocity generates a negative pressure gain (shown in the figure as a positive pressure drop).
- Mode **3**: reverse motor — A negative pressure drop generates a negative shaft angular velocity.
- Mode **4**: forward pump — A positive shaft angular velocity generates a positive pressure gain (shown in the figure as a negative pressure drop).

The response time of the motor is considered negligible in comparison with the system response time. The motor is assumed to reach steady state nearly instantaneously and is treated as a quasi-steady component.

Block Variants and Loss Parameterizations

The motor model accounts for power losses due to leakage and friction. Leakage is internal and occurs between the motor inlet and outlet only. The block computes the leakage flow rate and friction torque using your choice of five loss parameterizations. You select a parameterization using block variants and, in the Analytical or tabulated data case, the **Friction and leakage parameterization** parameter.

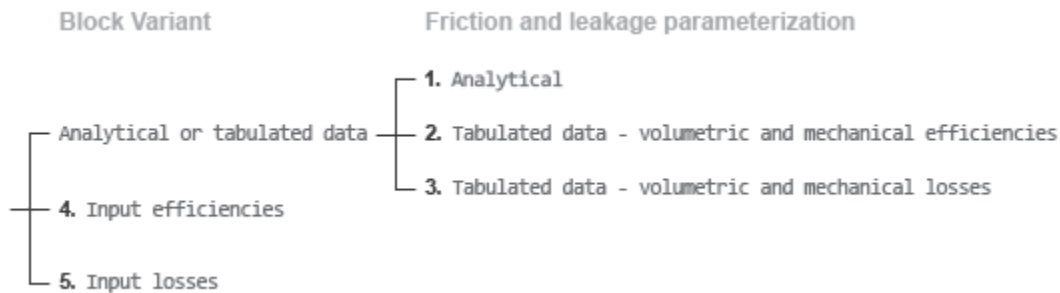

Loss Parameterizations

The block provides three Simulink® variants to select from. To change the active block variant, right-click the block and select **Simscape > Block choices**. The available variants are:

- **Analytical or tabulated data** — Obtain the mechanical and volumetric efficiencies or losses from analytical models based on nominal parameters or from tabulated data. Use the **Friction and leakage parameterization** parameter to select the exact input type.
- **Input efficiencies** — Provide the mechanical and volumetric efficiencies directly through physical signal input ports.
- **Input losses** — Provide the mechanical and volumetric losses directly through physical signal input ports. The mechanical loss is defined as the internal friction torque. The volumetric loss is defined as the internal leakage flow rate.

Flow Rate and Driving Torque

The volumetric flow rate required to power the motor is

$$q = q_{\text{Ideal}} + q_{\text{Leak}}$$

where:

- q is the net volumetric flow rate.
- q_{Ideal} is the ideal volumetric flow rate.
- q_{Leak} is the internal leakage volumetric flow rate.

The torque generated at the motor is

$$\tau = \tau_{\text{Ideal}} - \tau_{\text{Friction}}$$

where:

- τ is the net torque.

- τ_{Ideal} is the ideal torque.
- τ_{Friction} is the friction torque.

Ideal Flow Rate and Ideal Torque

The ideal volumetric flow rate is

$$q_{\text{Ideal}} = D\omega,$$

and the ideal generated torque is

$$\tau_{\text{Ideal}} = D\Delta p,$$

where:

- D is the specified value of the **Displacement** block parameter.
- ω is the instantaneous angular velocity of the rotary shaft.
- Δp is the instantaneous pressure drop from inlet to outlet.

Leakage Flow Rate and Friction Torque

The internal leakage flow rate and friction torque calculations depend on the block variant selected. If the block variant is **Analytical** or **tabulated data**, the calculations depend also on the **Leakage and friction parameterization** parameter setting. There are five possible permutations of block variant and parameterization settings.

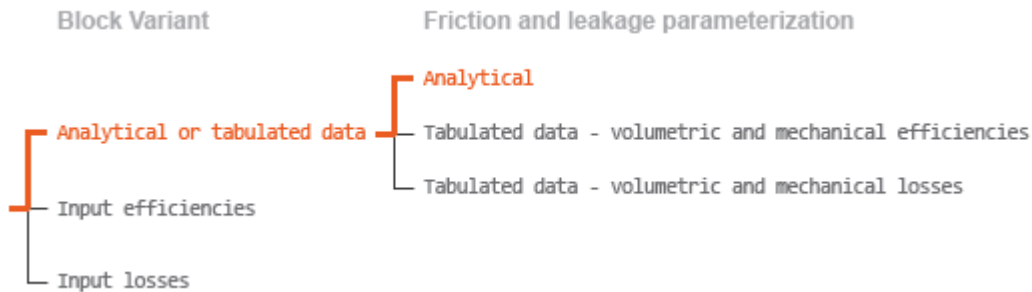

Case 1: Analytical Efficiency Calculation

If the active block variant is **Analytical** or **tabulated data** and the **Leakage and friction parameterization** parameter is set to **Analytical**, the leakage flow rate is

$$q_{\text{Leak}} = K_{\text{HP}}\Delta p,$$

and the friction torque is

$$\tau_{\text{Friction}} = (\tau_0 + K_{\text{TP}}|\Delta p|)\tanh\left(\frac{4\omega}{\omega_{\text{Threshold}}}\right),$$

where:

- K_{HP} is the Hagen-Poiseuille coefficient for laminar pipe flows. This coefficient is computed from the specified nominal parameters.

- K_{TP} is the specified value of the **Friction torque vs pressure drop coefficient** block parameter.
- τ_0 is the specified value of the **No-load torque** block parameter.
- $\omega_{Threshold}$ is the threshold angular velocity for the motor-pump transition. The threshold angular velocity is an internally set fraction of the specified value of the **Nominal shaft angular velocity** block parameter.

The Hagen-Poiseuille coefficient is determined from nominal fluid and component parameters through the equation

$$K_{HP} = \frac{\nu_{Nom} \rho_{Nom} \omega_{Nom} D_{Max}}{\rho v \Delta p_{Nom}} \left(\frac{1}{\eta_{v,Nom}} - 1 \right),$$

where:

- ν_{Nom} is the specified value of the **Nominal kinematic viscosity** block parameter. This is the kinematic viscosity at which the nominal volumetric efficiency is specified.
- ρ_{Nom} is the specified value of the **Nominal fluid density** block parameter. This is the density at which the nominal volumetric efficiency is specified.
- ω_{Nom} is the specified value of the **Nominal shaft angular velocity** block parameter. This is the angular velocity at which the nominal volumetric efficiency is specified.
- ρ is the actual fluid density in the attached hydraulic (isothermal liquid) network. This density can differ from the specified value of the **Nominal fluid density** block parameter.
- v is the kinematic viscosity of the fluid associated with the fluid network.
- Δp_{Nom} is the specified value of the **Nominal pressure drop** block parameter. This is the pressure drop at which the nominal volumetric efficiency is specified.
- $\eta_{v,Nom}$ is the specified value of the **Volumetric efficiency at nominal conditions** block parameter. This is the volumetric efficiency corresponding to the specified nominal conditions.

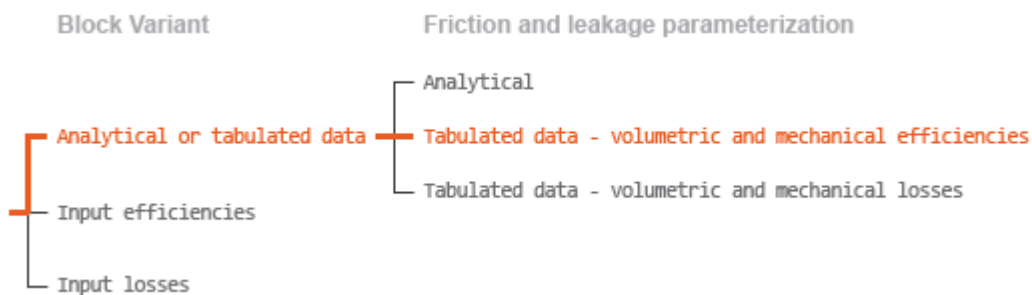

Case 2: Efficiency Tabulated Data

If the active block variant is Analytical or tabulated data and the **Leakage and friction parameterization** parameter is set to Tabulated data – volumetric and mechanical efficiencies, the leakage flow rate is

$$q_{Leak} = q_{Leak, Motor} \frac{(1 + \alpha)}{2} + q_{Leak, Pump} \frac{(1 - \alpha)}{2},$$

and the friction torque is

$$\tau_{Friction} = \tau_{Friction, Motor} \frac{1 + \alpha}{2} + \tau_{Friction, Pump} \frac{1 - \alpha}{2},$$

where:

- α is a numerical smoothing parameter for the motor-pump transition.
- $q_{\text{Leak, Motor}}$ is the leakage flow rate in motor mode.
- $q_{\text{Leak, Pump}}$ is the leakage flow rate in pump mode.
- $\tau_{\text{Friction, Motor}}$ is the friction torque in motor mode.
- $\tau_{\text{Friction, Pump}}$ is the friction torque in pump mode.

The smoothing parameter α is given by the hyperbolic function

$$\alpha = \tanh\left(\frac{4\Delta p}{\Delta p_{\text{Threshold}}}\right) \cdot \tanh\left(\frac{4\omega}{\omega_{\text{Threshold}}}\right),$$

where:

- $\Delta p_{\text{Threshold}}$ is the specified value of the **Pressure drop threshold for motor-pump transition** block parameter.
- $\omega_{\text{Threshold}}$ is the specified value of the **Angular velocity threshold for motor-pump transition** block parameter.

The leakage flow rate is computed from efficiency tabulated data through the equation

$$q_{\text{Leak, Motor}} = (1 - \eta_v)q,$$

in motor mode and through the equation

$$q_{\text{Leak, Pump}} = -(1 - \eta_v)q_{\text{Ideal}}.$$

in pump mode, where:

- η_v is the volumetric efficiency obtained through interpolation or extrapolation of the **Volumetric efficiency table, e_v(dp,w)** parameter data.

Similarly, the friction torque is computed from efficiency tabulated data through the equation

$$\tau_{\text{Friction, Motor}} = (1 - \eta_m)\tau_{\text{Ideal}},$$

in motor mode and through the equation

$$\tau_{\text{Friction, Pump}} = -(1 - \eta_m)\tau.$$

in pump mode, where:

- η_m is the mechanical efficiency obtained through interpolation or extrapolation of the **Mechanical efficiency table, e_m(dp,w)** parameter data.

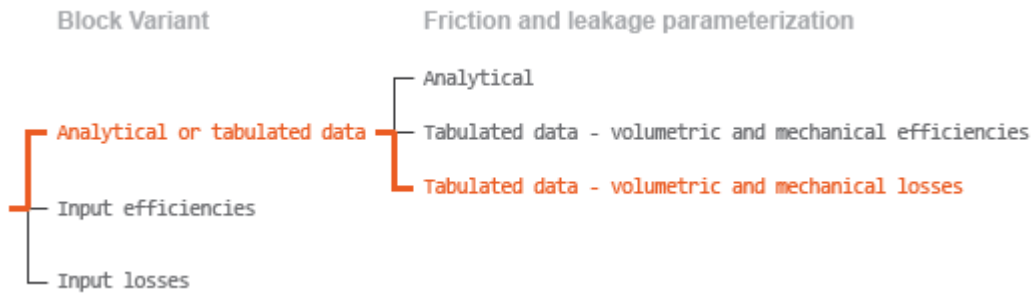

Case 3: Loss Tabulated Data

If the active block variant is Analytical or tabulated data and the **Leakage and friction parameterization** parameter is set to Tabulated data – volumetric and mechanical losses, the leakage flow rate equation is

$$q_{\text{Leak}} = q_{\text{Leak}}(\Delta p, \omega).$$

and the friction torque equation is

$$\tau_{\text{Friction}} = \tau_{\text{Friction}}(\Delta p, \omega),$$

where $q_{\text{Leak}}(\Delta p, \omega)$ and $\tau_{\text{Friction}}(\Delta p, \omega)$ are the volumetric and mechanical losses, obtained through interpolation or extrapolation of the **Volumetric loss table, $q_{\text{loss}}(\Delta p, \omega)$** and **Mechanical loss table, torque_loss ($\Delta p, \omega$)** parameter data.

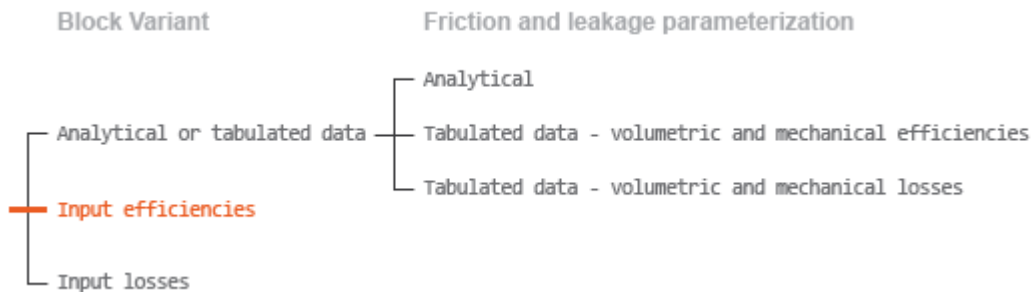

Case 4: Efficiency Physical Signal Inputs

If the active block variant is Input efficiencies, the leakage flow rate and friction torque calculations are as described for efficiency tabulated data (case 2). The volumetric and mechanical efficiency lookup tables are replaced with physical signal inputs that you specify through ports EV and EM.

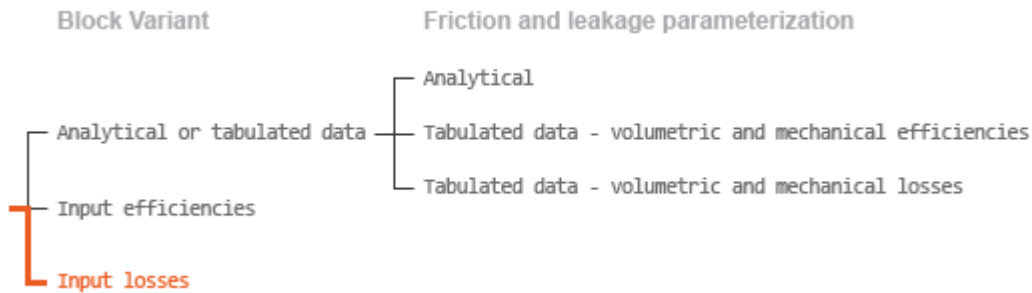

Case 5: Loss Physical Signal Inputs

If the block variant is `Input losses`, the leakage flow rate and friction torque calculations are as described for loss tabulated data (case 3). The volumetric and mechanical loss lookup tables are replaced with physical signal inputs that you specify through ports LV and LM.

Characteristic Curve Visualization

If the block variant is set to `Analytical or tabulated data`, you can plot a variety of performance, efficiency, and loss curves from simulation data and component parameters. Use the context-sensitive menu of the block to plot the characteristic curves. Right-click the block to open the menu and select **Fluids > Plot characteristic**. A test harness opens with instructions on how to generate the curves. See .

Assumptions

- Fluid compressibility is negligible.
- Loading on the motor shaft due to inertia, friction, and spring forces is negligible.

Ports

Input

EV — Volumetric efficiency, unitless

physical signal

Physical signal input port for the volumetric efficiency coefficient. The input signal has an upper bound at the **Maximum volumetric efficiency** parameter value and a lower bound at the **Minimum volumetric efficiency** parameter value.

Dependencies

This port is exposed only when the block variant is set to `Input efficiencies`.

EM — Mechanical efficiency, unitless

physical signal

Physical signal input port for the mechanical efficiency coefficient. The input signal has an upper bound at the **Maximum mechanical efficiency** parameter value and a lower bound at the **Minimum mechanical efficiency** parameter value.

Dependencies

This port is exposed only when the block variant is set to Input efficiencies.

LV – Volumetric loss, m³/s

physical signal

Physical signal input port for the volumetric loss, defined as the internal leakage flow rate between the motor inlets.

Dependencies

This port is exposed only when the block variant is set to Input losses.

LM – Mechanical loss, N*m

physical signal

Physical signal input port for the mechanical loss, defined as the friction torque on the rotating motor shaft.

Dependencies

This port is exposed only when the block variant is set to Input losses.

Conserving**A – Motor inlet**

hydraulic (isothermal)

Hydraulic (isothermal liquid) port representing the motor inlet.

B – Motor outlet

hydraulic (isothermal)

Hydraulic (isothermal liquid) port representing the motor outlet.

S – Motor shaft

mechanical rotational

Mechanical rotational port representing the motor shaft.

Parameters

The exposed block parameters depend on the active block variant. See “Block Variants and Loss Parameterizations” on page 1-673.

Variant 1: Analytical or tabulated data**Displacement – Fluid volume displaced per unit shaft rotation angle**

30 cm³/rev (default) | scalar with units of volume/angle

Fluid volume displaced per unit shaft rotation angle. The displacement is fixed at this value during simulation. The specified value must be greater than zero.

Leakage and friction parameterization – Parameterization used to compute leakage flow rate and friction torque

Analytical (default)

Parameterization used to compute flow-rate and torque losses due to internal leaks and friction. The **Analytical** parameterization relies on nominal parameters generally available from component data sheets. The remaining, tabular, options rely on lookup tables to map pressure drop and angular velocity to component efficiencies or losses. The tabular options include:

- Tabulated data – volumetric and mechanical efficiencies
- Tabulated data – volumetric and mechanical losses

Dependencies

This parameter is enabled when the block variant is set to **Analytical** or **tabulated data**.

Nominal shaft angular velocity – Shaft angular velocity at which to specify the nominal volumetric efficiency

188 rad/s (default) | scalar with units of angle/time

Angular velocity of the rotating shaft at which the component's nominal volumetric efficiency is known. Nominal parameters are typically published for standard operating conditions in manufacturer's data sheets. The block uses this parameter to calculate, using simple linear functions, the leakage flow rate and friction torque.

Dependencies

This parameter is enabled when the block variant is set to **Analytical** or **tabulated data** and the **Leakage and friction parameterization** parameter is set to **Analytical**.

Nominal pressure drop – Pressure gain at which to specify the nominal volumetric efficiency

100e5 Pa (default) | scalar with units of pressure

Pressure drop from inlet to outlet at which the component's nominal volumetric efficiency is known. Nominal parameters are typically published for standard operating conditions in manufacturer's data sheets. The block uses this parameter to calculate, using a simple linear function, the internal leakage flow rate.

Dependencies

This parameter is enabled when the block variant is set to **Analytical** or **tabulated data** and the **Leakage and friction parameterization** parameter is set to **Analytical**.

Nominal kinematic viscosity – Kinematic viscosity at which to specify the nominal volumetric efficiency

18 cSt (default) | scalar with units of area/time

Kinematic viscosity of the hydraulic fluid at which the component's nominal volumetric efficiency is known. Nominal parameters are typically published for standard operating conditions in manufacturer's data sheets. The block uses this parameter to calculate, using a simple linear function, the internal leakage flow rate.

Dependencies

This parameter is enabled when the block variant is set to **Analytical** or **tabulated data** and the **Leakage and friction parameterization** parameter is set to **Analytical**.

Nominal fluid density – Fluid density at which to specify the nominal volumetric efficiency900 kg/m³ (default) | scalar with units of mass/volume

Mass density of the hydraulic fluid at which the component's nominal volumetric efficiency is known. Nominal parameters are typically published for standard operating conditions in manufacturer's data sheets. The block uses this parameter to calculate, using a simple linear function, the internal leakage flow rate.

Dependencies

This parameter is enabled when the block variant is set to Analytical or tabulated data and the **Leakage and friction parameterization** parameter is set to Analytical.

Volumetric efficiency at nominal conditions – Volumetric efficiency at the specified nominal conditions

0.92 (default) | unitless scalar between 0 and 1

Volumetric efficiency, defined as the ratio of actual to ideal volumetric flow rates, at the specified nominal conditions. Nominal parameters are typically published for standard operating conditions in manufacturer's data sheets. The block uses this parameter to calculate, using a simple linear function, the internal leakage flow rate.

Dependencies

This parameter is enabled when the block variant is set to Analytical or tabulated data and the **Leakage and friction parameterization** parameter is set to Analytical.

No-load torque – Minimum torque required to induce shaft rotation

0.05 N*m (default) | scalar with units of torque

Torque required to overcome seal friction and induce rotation of the mechanical shaft. This torque is the load-independent component of the total friction torque.

Dependencies

This parameter is enabled when the block variant is set to Analytical or tabulated data and the **Leakage and friction parameterization** parameter is set to Analytical.

Friction torque vs. pressure drop coefficient – Proportionality constant between friction torque and pressure drop

0.6e-6 N*m/Pa (default) | scalar with units of torque/pressure

Proportionality constant between the friction torque on the mechanical shaft and the pressure drop from inlet to outlet.

Dependencies

This parameter is enabled when the block variant is set to Analytical or tabulated data and the **Leakage and friction parameterization** parameter is set to Tabulated data – volumetric and mechanical efficiencies.

Check if lower side pressure violating minimum valid condition – Simulation warning mode for minimum valid pressure

None (default) | Warning

Simulation warning mode for invalid pressures at the component ports. Select `Warning` to be notified when pressure falls below a minimum specified value. The warning can be useful in models where pressure can fall below the saturated vapor pressure of the hydraulic fluid, causing cavitation to occur.

Minimum valid pressure — Pressure required to trigger simulation warning

0 (default) | scalar with units of pressure

Lower bound of the pressure validity range. A warning is issued if pressure falls below the specified value.

Dependencies

This parameter is enabled when the **Check if lower side pressure violating minimum valid condition** parameter is set to `Warning`.

Pressure drop vector for efficiencies, `dp` — Pressure drops at which to specify the volumetric and mechanical efficiencies

M -element vector with units of pressure (default)

M -element vector of pressure gains at which to specify the efficiency tabular data. The vector size, M , must be two or greater. The vector elements need not be uniformly spaced. However, they must monotonically increase in value from left to right.

Dependencies

This parameter is enabled when the block variant is set to `Analytical` or `tabulated data` and the **Leakage and friction parameterization** parameter is set to `Tabulated data – volumetric and mechanical efficiencies`.

Shaft angular velocity vector for efficiencies, `w` — Angular velocities at which to specify the volumetric and mechanical efficiencies

N -element vector with units of angular velocity (default)

N -element vector of shaft angular velocities at which to specify the efficiency tabular data. The vector size, N , must be two or greater. The vector elements need not be uniformly spaced. However, they must monotonically increase in value from left to right.

Dependencies

This parameter is enabled when the block variant is set to `Analytical` or `tabulated data` and the **Leakage and friction parameterization** parameter is set to `Tabulated data – volumetric and mechanical efficiencies`.

Volumetric efficiency table, `e_v(dp,w)` — Volumetric efficiencies at the specified pressure drops and angular velocities

unitless M -by- N matrix

M -by- N matrix with the volumetric efficiencies at the specified fluid pressure drops and shaft angular velocities. The efficiencies must fall in the range of 0-1. M and N are the sizes of the specified lookup-table vectors:

- M is the number of vector elements in the **Pressure drop vector for efficiencies, `dp`** parameter.
- N is the number of vector elements in the **Shaft angular velocity vector for efficiencies, `w`** parameter.

Dependencies

This parameter is enabled when the block variant is set to `Analytical` or `tabulated data` and the **Leakage and friction parameterization** parameter is set to `Tabulated data – volumetric and mechanical efficiencies`.

Mechanical efficiency table, $e_m(dp,w)$ – Mechanical efficiencies at the specified pressure drops and angular velocities

unitless M -by- N matrix

M -by- N matrix with the mechanical efficiencies corresponding to the specified fluid pressure drops and shaft angular velocities. The efficiencies must fall in the range of 0-1. M and N are the sizes of the specified lookup-table vectors:

- M is the number of vector elements in the **Pressure drop vector for efficiencies, dp** parameter.
- N is the number of vector elements in the **Shaft angular velocity vector for efficiencies, w** parameter.

Dependencies

This parameter is enabled when the block variant is set to `Analytical` or `tabulated data` and the **Leakage and friction parameterization** parameter is set to `Tabulated data – volumetric and mechanical efficiencies`.

Pressure drop threshold for motor-pump transition – Pressure drop at which to initiate a smooth transition between motoring and pumping modes

$1e5$ Pa (default) | scalar with units of pressure

Pressure drop from inlet to outlet below which the component begins to transition between motoring and pumping modes. A hyperbolic Tanh function transforms the leakage flow rate and friction torque such that the transition is continuous and smooth.

Dependencies

This parameter is enabled when the block variant is set to `Input efficiencies` or when the block variant is set to `Analytical` or `tabulated data` and the **Leakage and friction parameterization** parameter is set to `Tabulated data – volumetric and mechanical efficiencies`.

Angular velocity threshold for pump–motor transition – Shaft angular velocity at which to initiate a smooth transition between motoring and pumping modes

10 rad/s (default) | scalar with units of angle/time

Shaft angular velocity below which the component begins to transition between motoring and pumping modes. A hyperbolic Tanh function transforms the leakage flow rate and friction torque such that the transition is continuous and smooth.

Dependencies

This parameter is enabled when the block variant is set to `Input efficiencies` or when the block variant is set to `Analytical` or `tabulated data` and the **Leakage and friction parameterization** parameter is set to `Tabulated data – volumetric and mechanical efficiencies`.

Check if operating beyond the quadrants of supplied tabulated data – Simulation warning mode for operating conditions outside the range of tabulated data

None (default) | Warning

Simulation warning mode for operating conditions outside the range of tabulated data. Select **Warning** to be notified when the fluid pressure gain or shaft angular velocity cross outside the specified tabular data. The warning does not cause simulation to stop.

Dependencies

This parameter is enabled when the block variant is set to **Analytical** or **tabulated data** and the **Leakage and friction parameterization** parameter is set to **Tabulated data – volumetric and mechanical efficiencies** or **Tabulated data – volumetric and mechanical losses**.

Pressure drop vector for losses, dp – Pressure drops at which to specify the volumetric and mechanical losses*M*-element vector with units of pressure (default)

M-element vector of pressure drops at which to specify the loss tabular data. The vector size, *M*, must be two or greater. The vector elements need not be uniformly spaced. However, they must monotonically increase in value from left to right.

Dependencies

This parameter is enabled when the block variant is set to **Analytical** or **tabulated data** and the **Leakage and friction parameterization** parameter is set to **Tabulated data – volumetric and mechanical losses**.

Shaft angular velocity vector for losses, w – Angular velocities at which to specify the volumetric and mechanical losses*N*-element vector with units of angle/time (default)

N-element vector of shaft angular velocities at which to specify the component loss data. The vector size, *N*, must be two or greater. The vector elements need not be uniformly spaced. However, they must monotonically increase in value from left to right.

Dependencies

This parameter is enabled when the block variant is set to **Analytical** or **tabulated data** and the **Leakage and friction parameterization** parameter is set to **Tabulated data – volumetric and mechanical losses**.

Volumetric loss table, q_loss(dp,w) – Internal leakage flow rates at the specified pressure gains and angular velocities*M*-by-*N* matrix with units of volume/time

M-by-*N* matrix with the volumetric gains at the specified fluid pressure drops and shaft angular velocities. Volumetric loss is defined here as the internal leakage volumetric flow rate between port A and port B. *M* and *N* are the sizes of the specified lookup-table vectors:

- *M* is the number of vector elements in the **Pressure drop vector for losses, dp** parameter.
- *N* is the number of vector elements in the **Shaft angular velocity vector for losses, w** parameter.

Dependencies

This parameter is enabled when the block variant is set to Analytical or tabulated data and the **Leakage and friction parameterization** parameter is set to Tabulated data – volumetric and mechanical losses.

Mechanical loss table, torque_loss(dp,w) – Friction torques at the specified pressure gains and angular velocities

M-by-*N* matrix with units of torque

M-by-*N* matrix with the mechanical losses at the specified fluid pressure drops and shaft angular velocities. Mechanical loss is defined here as the friction torque due to seals and internal components. *M* and *N* are the sizes of the specified lookup-table vectors:

- *M* is the number of vector elements in the **Pressure drop vector for losses, dp** parameter.
- *N* is the number of vector elements in the **Shaft angular velocity vector for losses, w** parameter.

Dependencies

This parameter is enabled when the block variant is set to Analytical or tabulated data and the **Leakage and friction parameterization** parameter is set to Tabulated data – volumetric and mechanical losses.

Variant 2: Input efficiencies**Displacement – Fluid volume displaced per unit shaft rotation angle**

30 cm³/rev (default) | scalar with units of volume/angle

Fluid volume displaced per unit shaft rotation angle. The displacement is fixed at this value during simulation. The specified value must be greater than zero.

Pressure drop threshold for motor-pump transition – Pressure drop at which to initiate a smooth transition between motoring and pumping modes

1e5 Pa (default) | scalar with units of pressure

Pressure drop from inlet to outlet below which the component begins to transition between motoring and pumping modes. A hyperbolic Tanh function transforms the leakage flow rate and friction torque such that the transition is continuous and smooth.

Dependencies

This parameter is enabled when the block variant is set to Input efficiencies.

Angular velocity threshold for motor-pump transition – Shaft angular velocity at which to initiate a smooth transition between motoring and pumping modes

10 rad/s (default) | scalar with units of angle/time

Shaft angular velocity below which the component begins to transition between motoring and pumping modes. A hyperbolic Tanh function transforms the leakage flow rate and friction torque such that the transition is continuous and smooth.

Dependencies

This parameter is enabled when the block variant is set to Input efficiencies.

Minimum volumetric efficiency – Lower saturation bound on the volumetric efficiency input signal

1e-3 (default) | unitless scalar between 0 and 1

Smallest allowed value of the volumetric efficiency. The input from physical signal port EV saturates at the specified value. If the input signal falls below the minimum volumetric efficiency, the volumetric efficiency is set to the minimum volumetric efficiency.

Dependencies

This parameter is enabled when the block variant is set to Input efficiencies.

Maximum volumetric efficiency – Upper saturation bound on the volumetric efficiency input signal

1 (default) | unitless scalar between 0 and 1

Largest allowed value of the volumetric efficiency. The input from physical signal port EV saturates at the specified value. If the input signal rises above the maximum volumetric efficiency, the volumetric efficiency is set to the maximum volumetric efficiency.

Dependencies

This parameter is enabled when the block variant is set to Input efficiencies.

Minimum mechanical efficiency – Lower saturation bound on the volumetric efficiency input signal

1e-3 (default) | unitless scalar between 0 and 1

Smallest allowed value of the mechanical efficiency. The input from physical signal port EM saturates at the specified value. If the input signal falls below the minimum mechanical efficiency, the mechanical efficiency is set to the minimum mechanical efficiency.

Dependencies

This parameter is enabled when the block variant is set to Input efficiencies.

Maximum mechanical efficiency – Upper saturation bound on the volumetric efficiency input signal

1 (default) | unitless scalar between 0 and 1

Largest allowed value of the mechanical efficiency. The input from physical signal port EM saturates at this value. If the input signal rises above the maximum mechanical efficiency, the mechanical efficiency is set to the maximum mechanical efficiency.

Dependencies

This parameter is enabled when the block variant is set to Input efficiencies.

Check if lower side pressure violating minimum valid condition – Simulation warning mode for minimum valid pressure

None (default) | Warning

Simulation warning mode for invalid pressures at the component ports. Select Warning to be notified when pressure falls below a minimum specified value. The warning can be useful in models where pressure can fall below the saturated vapor pressure of the hydraulic fluid, causing cavitation to occur.

Minimum valid pressure — Pressure required to trigger simulation warning

0 (default) | scalar with units of pressure

Lower bound of the pressure validity range. A warning is issued if pressure falls below the specified value.

Dependencies

This parameter is enabled when the **Check if lower side pressure violating minimum valid condition** parameter is set to Warning.

Variant 3: Input losses**Displacement — Fluid volume displaced per unit shaft rotation angle**30 cm³/rev (default) | scalar with units of volume/angle

Fluid volume displaced per unit shaft rotation angle. The displacement is fixed at this value during simulation. The specified value must be greater than zero.

Check if operating beyond the motor mode — Simulation warning mode for operating conditions outside motoring mode

None (default) | Warning

Simulation warning mode for operating conditions outside the motoring mode. A warning is issued if the motor transitions to pumping mode. Select Warning to be notified when this transition occurs. The warning does not cause simulation to stop.

Dependencies

This parameter is enabled when the block variant is set to Input losses.

Check if lower side pressure violating minimum valid condition — Simulation warning mode for minimum valid pressure

None (default) | Warning

Simulation warning mode for invalid pressures at the component ports. Select Warning to be notified when pressure falls below a minimum specified value. The warning can be useful in models where pressure can fall below the saturated vapor pressure of the hydraulic fluid, causing cavitation to occur.

Minimum valid pressure — Pressure required to trigger simulation warning

0 (default) | scalar with units of pressure

Lower bound of the pressure validity range. A warning is issued if pressure falls below the specified value.

Dependencies

This parameter is enabled when the **Check if lower side pressure violating minimum valid condition** parameter is set to Warning.

Extended Capabilities**C/C++ Code Generation**

Generate C and C++ code using Simulink® Coder™.

See Also

Fixed-Displacement Pump | Variable-Displacement Pump | Variable-Displacement Motor | Fixed-Displacement Pump (TL) | Fixed-Displacement Motor (TL)

Topics

“Upgrading Simscape Fluids Models Containing Hydraulics (Isothermal) Blocks”

Introduced in R2006b

Fixed-Displacement Motor (IL)

Fixed-displacement motor in isothermal liquid system

Library: Simscape / Fluids / Isothermal Liquid / Pumps & Motors

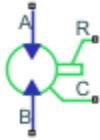

Description

The Fixed-Displacement Motor (IL) block models a motor with constant-volume displacement. The fluid may move from port **A** to port **B**, called *forward mode*, or from port **B** to port **A**, called *reverse mode*. Motor mode operation occurs when there is a pressure drop in the direction of the flow. Pump mode operation occurs when there is a pressure gain in the direction of the flow.

Shaft rotation corresponds to the sign of the fluid volume moving through the motor. Positive fluid displacement at corresponds to positive shaft rotation in forward mode. Negative fluid displacement corresponds to negative shaft angular velocity in forward mode.

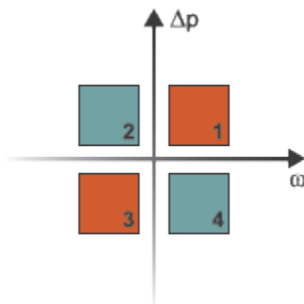

Operation Modes

The block has eight modes of operation. The working mode depends on the pressure drop from port **A** to port **B**, $\Delta p = p_A - p_B$ and the angular velocity, $\omega = \omega_R - \omega_C$:

- Mode 1, *Forward Motor*: Flow from port **A** to port **B** causes a pressure decrease from **A** to **B** and a positive shaft angular velocity.
- Mode 2, *Reverse Pump*: Negative shaft angular velocity causes a pressure increase from port **B** to port **A** and flow from **B** to port **A**.
- Mode 3, *Reverse Motor*: Flow from port **B** to port **A** causes a pressure decrease from **B** to **A** and a negative shaft angular velocity.
- Mode 4, *Forward Pump*: Positive shaft angular velocity causes a pressure increase from port **A** to port **B** and flow from **A** to **B**.

The motor block has analytical, lookup table, and physical signal parameterizations. When using tabulated data or an input signal for parameterization, you can choose to characterize the motor operation based on efficiency or losses.

In the tabulated data and the input signal parameterization options, the threshold parameters **Pressure drop threshold for motor-pump transition** and **Angular velocity threshold for motor-pump transition** identify regions where numerically smoothed flow transition between the motor operational modes can occur. Choose a transition region that provides some margin for the transition term, but which is small enough relative to the pressure and angular velocity that it will not impact calculation results.

Analytical Leakage and Friction Parameterization

If you set **Leakage and friction parameterization** to **Analytical**, the block calculates leakage and friction from constant values of shaft velocity, pressure drop, and friction torque. The leakage flow rate, which is correlated with the pressure differential over the motor, is calculated as:

$$\dot{m}_{leak} = K\rho_{avg}\Delta p,$$

where:

- Δp_{nom} is the **Nominal pressure drop**.
- ρ_{avg} is the average fluid density.
- K is the Hagen-Poiseuille coefficient for analytical loss,

$$K = \frac{D\omega_{nom}\left(\frac{1}{\eta_{v,nom}} - 1\right)}{\Delta p_{nom}},$$

where:

- D is the **Displacement**.
- ω_{nom} is the **Nominal shaft angular velocity**.
- $\eta_{v,nom}$ is the **Volumetric efficiency at nominal conditions**.
- Δp_{nom} is the **Nominal pressure drop**.

The friction torque, which is correlated with shaft angular velocity, is calculated as:

$$\tau_{fr} = (\tau_0 + k|\Delta p|)\tanh\left(\frac{4\omega}{5 \times 10^{-5}\omega_{nom}}\right),$$

where:

- τ_0 is the **No-load torque**.
- k is the friction torque vs. pressure gain coefficient at nominal displacement, which is determined from the **Mechanical efficiency at nominal conditions**, η_m :

$$k = \frac{\tau_{fr,nom} - \tau_0}{\Delta p_{nom}}.$$

τ_{fric} is the friction torque at nominal conditions:

$$\tau_{fr,nom} = (1 - \eta_{m,nom})D\Delta p_{nom}.$$

- Δp is the pressure drop between ports **A** and **B**.
- ω is the relative shaft angular velocity, or $\omega_R - \omega_C$.

Tabulated Data Parameterizations

When using tabulated data for motor efficiencies or losses, you can provide data for one or more of the motor operational modes. The signs of the tabulated data determine the operational regime of the block. When data is provided for less than four operational modes, the block calculates the complementing data for the other mode(s) by extending the given data into the remaining quadrants.

The Tabulated data - volumetric and mechanical efficiencies parameterization

The leakage flow rate is calculated as:

$$\dot{m}_{leak} = \dot{m}_{leak, motor} \left(\frac{1 + \alpha}{2} \right) + \dot{m}_{leak, pump} \left(\frac{1 - \alpha}{2} \right),$$

where:

- $\dot{m}_{leak, pump} = (\eta_v - 1) \dot{m}_{ideal}$
- $\dot{m}_{leak, motor} = (1 - \eta_v) \dot{m}$

and η_v is the volumetric efficiency, which is interpolated from the user-provided tabulated data. The transition term, α , is

$$\alpha = \tanh\left(\frac{4\Delta p}{\Delta p_{threshold}}\right) \tanh\left(\frac{4\omega}{\omega_{threshold}}\right),$$

where:

- Δp is $p_A - p_B$.
- $p_{threshold}$ is the **Pressure drop threshold for motor-pump transition**.
- ω is $\omega_R - \omega_C$.
- $\omega_{threshold}$ is the **Angular velocity threshold for motor-pump transition**.

The friction torque is calculated as:

$$\tau_{fr} = \tau_{fr, pump} \left(\frac{1 + \alpha}{2} \right) + \tau_{fr, motor} \left(\frac{1 - \alpha}{2} \right),$$

where:

- $\tau_{fr, pump} = (\eta_m - 1) \tau$
- $\tau_{fr, motor} = (1 - \eta_m) \tau_{ideal}$

and η_m is the mechanical efficiency, which is interpolated from the user-provided tabulated data.

The Tabulated data - volumetric and mechanical losses parameterization

The leakage flow rate is calculated as:

$$\dot{m}_{leak} = \rho_{avg} q_{loss}(\Delta p, \omega),$$

where q_{loss} is interpolated from the **Volumetric loss table, $q_{loss}(dp, w)$** parameter, which is based on user-supplied data for pressure drop, shaft angular velocity, and fluid volumetric displacement.

The shaft friction torque is calculated as:

$$\tau_{fr} = \tau_{loss}(\Delta p, \omega),$$

where τ_{loss} is interpolated from the **Mechanical loss table, torque_loss(dp,w)** parameter, which is based on user-supplied data for pressure drop and shaft angular velocity.

Input Signal Parameterization

When **Leakage and friction parameterization** is set to **Input signal - volumetric and mechanical efficiencies**, ports **EV** and **EM** are enabled. The internal leakage and shaft friction are calculated in the same way as the **Tabulated data - volumetric and mechanical efficiencies** parameterization, except that η_v and η_m are received directly at ports **EV** and **EM**, respectively.

When **Leakage and friction parameterization** is set to **Input signal - volumetric and mechanical losses**, ports **LV** and **LM** are enabled. These ports receive leakage flow and friction torque as positive physical signals. The leakage flow rate is calculated as:

$$\dot{m}_{leak} = \rho_{avg} q_{LV} \tanh\left(\frac{4\Delta p}{p_{thresh}}\right),$$

where:

- q_{LV} is the leakage flow received at port **LV**.
- p_{thresh} is the **Pressure drop threshold for motor-pump transition** parameter.

The friction torque is calculated as:

$$\tau_{fr} = \tau_{LM} \tanh\left(\frac{4\omega}{\omega_{thresh}}\right),$$

where

- τ_{LM} is the friction torque received at port **LM**.
- ω_{thresh} is the **Angular velocity threshold for motor-pump transition** parameter.

The volumetric and mechanical efficiencies range between the user-defined specified minimum and maximum values. Any values lower or higher than this range will take on the minimum and maximum specified values, respectively.

Pump Operation

The motor flow rate is:

$$\dot{m} = \dot{m}_{ideal} + \dot{m}_{leak},$$

where $\dot{m}_{ideal} = \rho_{avg} D \cdot \omega$.

The motor torque is:

$$\tau = \tau_{ideal} - \tau_{fr},$$

where $\tau_{ideal} = D \cdot \Delta p$.

The mechanical power extracted by the motor shaft is:

$$\varphi_{mech} = \tau\omega,$$

and the motor hydraulic power is:

$$\varphi_{hyd} = \frac{\Delta p \dot{m}}{\rho_{avg}}.$$

If you would like to know if the block is operating beyond the supplied tabulated data, you can set **Check if operating beyond the quadrants of supplied tabulated data** to *Warning* to receive a warning if this occurs, or *Error* to stop the simulation when this occurs. For parameterization by input signal for volumetric or mechanical losses, you can be notified if the simulation surpasses operating modes with the **Check if operating outside of motor mode** parameter.

You can also monitor motor functionality. Set **Check if pressures are less than motor minimum pressure** to *Warning* to receive a warning if this occurs, or *Error* to stop the simulation when this occurs.

Ports

Conserving

A – Liquid port

isothermal liquid

Entry or exit port to the motor.

B – Liquid port

isothermal liquid

Entry or exit port to the motor.

R – Mechanical port

mechanical rotational

Rotating shaft angular velocity and torque.

C – Mechanical port

mechanical rotational

Motor casing reference angular velocity and torque.

Input

EV – Volumetric efficiency

physical signal

Motor efficiency for fluid displacement, specified as a physical signal. The value must be between 0 and 1.

Dependencies

To enable this port, set **Leakage and friction parameterization** to *Input signal - volumetric and mechanical efficiencies*.

EM – Mechanical efficiency

physical signal

Motor efficiency for the mechanical extraction of energy, specified as a physical signal. The value must be between 0 and 1.

Dependencies

To enable this port, set **Leakage and friction parameterization** to Input signal - volumetric and mechanical efficiencies.

LV – Leakage flow rate, m³/s

physical signal

Motor losses associated with fluid displacement in m³/s, specified as a physical signal.

Dependencies

To enable this port, set **Leakage and friction parameterization** to Input signal - volumetric and mechanical losses.

LM – Friction torque, N*m

physical signal

Motor losses associated with the mechanical extraction of energy in N*m, specified as a physical signal.

Dependencies

To enable this port, set **Leakage and friction parameterization** to Input signal - volumetric and mechanical losses.

Parameters**Leakage and friction parameterization – Method of calculating leakage flow rate and friction torque**

Analytical (default) | Tabulated data - volumetric and mechanical efficiencies |
Tabulated data - volumetric and mechanical losses | Input signal - volumetric
and mechanical efficiencies | Input signal - volumetric and mechanical losses

Parameterization of the leakage and friction characteristics of the pump.

- In the **Analytical** parameterization, the leakage flow rate and the friction torque are calculated by analytical equations.
- In the **Tabulated data - volumetric and mechanical efficiencies** parameterization, the volumetric and mechanical efficiencies are calculated from the user-supplied **Pressure drop vector, dp** and **Shaft angular velocity vector, w** parameters and interpolated from the 2-D dependent **Volumetric efficiency table, e_v(dp,w)** and **Mechanical efficiency table, e_m(dp,w)** tables.
- In the **Tabulated data - volumetric and mechanical loss** parameterization, the leakage flow rate and torque friction are calculated from user-supplied **Pressure drop vector, dp** and **Shaft angular velocity vector, w** parameters and interpolated from the 2-D dependent **Volumetric loss table, q_loss(dp,w)** and **Mechanical loss table, torque_loss(dp,w)** tables.

- In the Input signal - volumetric and mechanical efficiencies parameterization, the volumetric and mechanical efficiencies are received as physical signals at ports **EV** and **EM**, respectively.
- In the Input signal - volumetric and mechanical loss parameterization, the leakage flow rate and torque friction are received as physical signals at ports **LV** and **LM**, respectively.

Displacement – Fixed-volume fluid displacement

30 cm³/rev (default) | scalar

Amount of fixed-volume fluid displacement.

Nominal shaft angular velocity – Shaft angular velocity

188 rad/s (default) | scalar

Angular velocity of the shaft under nominal operating conditions.

Dependencies

To enable this parameter, set **Leakage and friction parameterization** to Analytical.

Nominal pressure drop – Pressure drop between fluid entry and exit

10 MPa (default) | scalar

Motor pressure drop between the fluid entry and exit under nominal operating conditions.

Dependencies

To enable this parameter, set **Leakage and friction parameterization** to Analytical.

Volumetric efficiency at nominal conditions – Ratio of actual flow rate to ideal flow rate at nominal conditions

0.92 (default) | positive scalar in the range of (0,1]

Ratio of actual flow rate to ideal flow rate at nominal conditions.

Dependencies

To enable this parameter, set **Leakage and friction parameterization** to Analytical.

No-load torque – Baseline torque

0 N*m (default) | scalar

Minimum value of torque to overcome seal friction and induce shaft motion.

Dependencies

To enable this parameter, set **Leakage and friction parameterization** to Analytical.

Mechanical efficiency at nominal conditions – Ratio of actual torque to ideal torque generated

0.88 (default) | positive scalar

Ratio of actual torque to ideal torque generated at nominal conditions.

Dependencies

To enable this parameter, set **Leakage and friction parameterization** to Analytical.

Pressure drop vector, dp — Vector of pressure data for tabulated data parameterization
[.1, 1, 2] MPa (default) | 1-by- n vector

Vector of pressure differential values for the tabular parameterization of leakage and torque friction. This vector forms an independent axis with the **Shaft angular velocity vector, w** parameter for the 3-D dependent **Volumetric efficiency table, $e_v(dp,w)$** and **Mechanical efficiency table, $e_m(dp,w)$** parameters. The vector elements must be listed in ascending order.

Dependencies

To enable this parameter, set **Leakage and friction parameterization** to either:

- Tabulated data - volumetric and mechanical efficiencies
- Tabulated data - volumetric and mechanical losses

Shaft angular velocity vector, w — Vector of angular velocity data for tabulated data parameterization

[25, 50, 100, 200, 300, 400] rad/s (default) | 1-by- n vector

Vector of angular velocity data for the tabular parameterization of leakage and torque friction. This vector forms an independent axis with the **Shaft angular velocity vector, w** parameter for the 3-D dependent **Volumetric efficiency table, $e_v(dp,w)$** and **Mechanical efficiency table, $e_m(dp,w)$** parameters. The vector elements must be listed in ascending order.

Dependencies

To enable this parameter, set **Leakage and friction parameterization** to either:

- Tabulated data - volumetric and mechanical efficiencies
- Tabulated data - volumetric and mechanical losses

Volumetric efficiency table, $e_v(dp,w)$ — Volumetric efficiency for tabulated data parameterization

[.816, .908, .954, .977, .981, .984; .325, .663, .831, .916, .925, .946; .137, .568, .78, .892, .893, .91] (default) | M -by- N matrix

M -by- N matrix of volumetric efficiencies at the specified fluid pressure drop and shaft angular velocity. Linear interpolation is employed between table elements. M and N are the sizes of the correlated vectors:

- M is the number of vector elements in the **Pressure drop vector, dp** parameter.
- N is the number of vector elements in the **Shaft angular velocity vector, w** parameter.

Dependencies

To enable this parameter, set **Leakage and friction parameterization** to Tabulated data - volumetric and mechanical efficiencies.

Mechanical efficiency table, $e_m(dp,w)$ — Mechanical efficiency for tabulated data parameterization

[.996, .996, .996, .996, .996, .996; .988, .989, .989, .989, .989, .99; .981, .981, .982, .982, .983, .984] (default) | M -by- N matrix

M -by- N matrix of mechanical efficiencies at the specified fluid pressure drop and shaft angular velocity. Linear interpolation is employed between table elements. M and N are the sizes of the correlated vectors:

- M is the number of vector elements in the **Pressure drop vector, dp** parameter.
- N is the number of vector elements in the **Shaft angular velocity vector, w** parameter.

Dependencies

To enable this parameter, set **Leakage and friction parameterization** to Tabulated data - volumetric and mechanical efficiencies.

Volumetric loss table, $q_loss(dp,w)$ – Volumetric losses for tabulated data parameterization

[.023, .023, .023, .023, .0285, .032; .0844, .0842, .0845, .084, .1125, .108; .1079, .108, .11, .108, .1605, .18] * $1e-3$ m³/s (default) | M -by- N matrix

M -by- N matrix of volumetric efficiencies at the specified fluid pressure drop and shaft angular velocity. Linear interpolation is employed between table elements. M and N are the sizes of the correlated vectors:

- M is the number of vector elements in the **Pressure drop vector, dp** parameter.
- N is the number of vector elements in the **Shaft angular velocity vector, w** parameter.

Dependencies

To enable this parameter, set **Leakage and friction parameterization** to Tabulated data - volumetric and mechanical losses.

Mechanical loss table, $torque_loss(dp,w)$ – Mechanical losses for tabulated data parameterization

[.002, .002, .002, .002, .002, .002; .0607, .0556, .0556, .0556, .0556, .0505; .1937, .1937, .1833, .1833, .1729, .1626] N*m (default) | M -by- N matrix

M -by- N matrix of mechanical losses at the specified fluid pressure drop and shaft angular velocity. Linear interpolation is employed between table elements. M and N are the sizes of the correlated vectors:

- M is the number of vector elements in the **Pressure drop vector, dp** parameter.
- N is the number of vector elements in the **Shaft angular velocity vector, w** parameter.

Dependencies

To enable this parameter, set **Leakage and friction parameterization** to Tabulated data - volumetric and mechanical losses.

Minimum volumetric efficiency – Minimum value of volumetric efficiency

$1e-3$ (default) | positive scalar in the range of (0,1]

Minimum value of volumetric efficiency. If the input signal is below this value, the volumetric efficiency is set to the minimum volumetric efficiency.

Dependencies

To enable this parameter, set **Leakage and friction parameterization** to Input signal - volumetric and mechanical efficiencies.

Maximum volumetric efficiency – Maximum value of volumetric efficiency

1 (default) | positive scalar in the range of (0,1]

Maximum value of volumetric efficiency. If the input signal is above this value, the volumetric efficiency is set to the maximum volumetric efficiency.

Dependencies

To enable this parameter, set **Leakage and friction parameterization** to Input signal - volumetric and mechanical efficiencies.

Minimum mechanical efficiency – Minimum value of mechanical efficiency

1e-3 (default) | positive scalar in the range of (0,1]

Minimum value of mechanical efficiency. If the input signal is below this value, the mechanical efficiency is set to the minimum mechanical efficiency.

Dependencies

To enable this parameter, set **Leakage and friction parameterization** to Input signal - volumetric and mechanical efficiencies.

Maximum mechanical efficiency – Maximum value of mechanical efficiency

1 (default) | positive scalar in the range of (0,1]

Maximum value of mechanical efficiency. If the input signal is above this value, the mechanical efficiency is set to the maximum mechanical efficiency.

Dependencies

To enable this parameter, set **Leakage and friction parameterization** to Input signal - volumetric and mechanical efficiencies.

Pressure drop threshold for motor-pump transition – Pressure threshold for mode transition

1e-3 MPa (default) | positive scalar

Threshold pressure drop value for the transition between pump and motor functionality. A transition region is defined around 0 MPa between the positive and negative values of the pressure drop threshold. Within this transition region, the computed leakage flow rate and friction torque are adjusted according to the transition term α to ensure smooth transition from one mode to the other.

Dependencies

To enable this parameter, set **Leakage and friction parameterization** to either:

- Tabulated data - volumetric and mechanical efficiencies
- Input signal - volumetric and mechanical efficiencies
- Input signal - volumetric and mechanical losses

Angular velocity threshold for motor-pump transition – Angular velocity threshold for mode transition

10 rad/s (default) | positive scalar

Threshold angular velocity value for the transition between pump and motor functionality. A transition region is defined around 0 rad/s between the positive and negative values of the angular

velocity threshold. Within this transition region, the computed leakage flow rate and friction torque are adjusted according to the transition term α to ensure smooth transition from one mode to the other.

Dependencies

To enable this parameter, set **Leakage and friction parameterization** to either:

- Tabulated data - volumetric and mechanical efficiencies
- Input signal - volumetric and mechanical efficiencies
- Input signal - volumetric and mechanical losses

Check if operating beyond the quadrants of supplied tabulated data – Whether to notify if extents of supplied data are surpassed

None (default) | Warning | Error

Whether to notify if the extents of the supplied data are surpassed. Select Warning to be notified when the block uses values beyond the supplied data range. Select Error to stop the simulation when the block uses values beyond the supplied data range.

Dependencies

To enable this parameter, set **Leakage and friction parameterization** to:

- Tabulated data - volumetric and mechanical efficiencies
- Tabulated data - volumetric and mechanical losses

Check if operating outside of motor mode – Whether to notify if block operates outside of the motor mode functionality

None (default) | Warning | Error

Whether to notify if block operates outside of the motor mode functionality. This block has four operation modes: forward motor, reverse motor, reverse pump, and forward pump. Select Warning to be notified when the block operates in the forward or reverse motor pump modes. Select Error to stop the simulation when the block operates in the forward or reverse pump modes.

Dependencies

To enable this parameter, set **Leakage and friction parameterization** to Input signal - volumetric and mechanical losses.

Check if pressures are less than motor minimum pressure – Whether to notify if fluid exit pressure is low

None (default) | Warning | Error

Whether to notify if the fluid at port **A** or **B** experiences low pressure. Select Warning to be notified when the outlet pressure falls below a minimum specified value. Select Error to stop the simulation when the outlet pressure falls below a minimum specified value.

The parameter helps identify potential conditions for cavitation, when the fluid pressure falls below the fluid vapor pressure.

Motor minimum pressure – Lower threshold to acceptable pressure at the motor outlet

0.101325 MPa (default) | positive scalar

Lower threshold of acceptable pressure at the motor inlet or outlet.

Dependencies

To enable this parameter, set **Check if pressures are less than motor minimum pressure** to either:

- Warning
- Error

See Also

Variable-Displacement Motor (IL) | Fixed-Displacement Motor (TL) | Fixed-Displacement Pump (IL)

Topics

Introduced in R2020a

Fixed-Displacement Motor (TL)

Hydraulic-mechanical power conversion device

Library: Simscape / Fluids / Thermal Liquid / Pumps & Motors



Description

The Fixed-Displacement Motor (TL) block represents a device that extracts power from a thermal liquid network and delivers it to a mechanical rotational network. The motor displacement is fixed at a constant value that you specify through the **Displacement** parameter.

Ports **A** and **B** represent the motor inlets. Ports **R** and **C** represent the motor drive shaft and case. During normal operation, a pressure drop from port **A** to port **B** causes a positive flow rate from port **A** to port **B** and a positive rotation of the motor shaft relative to the motor case. This operation mode is referred to here as *forward motor*.

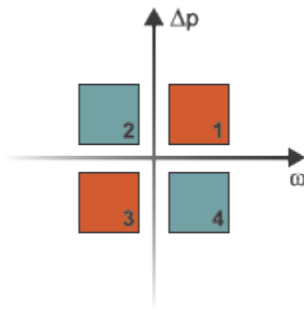

Operation Modes

The block has four modes of operation. The working mode depends on the pressure drop from port **A** to port **B**, $\Delta p = p_B - p_A$ and the angular velocity, $\omega = \omega_R - \omega_C$:

- Mode 1, *Forward Motor*: Flow from port **A** to port **B** causes a pressure decrease from **A** to **B** and a positive shaft angular velocity.
- Mode 2, *Reverse Pump*: Negative shaft angular velocity causes a pressure increase from port **B** to port **A** and flow from **B** to port **A**.
- Mode 3, *Reverse Motor*: Flow from port **B** to port **A** causes a pressure decrease from **B** to **A** and a negative shaft angular velocity.
- Mode 4, *Forward Pump*: Positive shaft angular velocity causes a pressure increase from port **A** to port **B** and flow from **A** to **B**.

The response time of the motor is considered negligible in comparison with the system response time. The motor is assumed to reach steady state nearly instantaneously and is treated as a quasi-steady component.

Energy Balance

Mechanical work done by the pump is associated with an energy exchange. The governing energy balance equation is:

$$\phi_A + \phi_B - P_{hydro} = 0,$$

where:

- Φ_A and Φ_B are energy flow rates at ports **A** and **B**, respectively.
- P_{hydro} is the motor hydraulic power. It is a function of the pressure difference between the motor ports: $P_{hydro} = \Delta p \frac{\dot{m}}{\rho}$

The motor mechanical power is generated from the motor torque, τ and angular velocity, ω :

$$P_{mech} = T\omega.$$

Flow Rate and Driving Torque

The mass flow rate generated at the motor is

$$\dot{m} = \dot{m}_{Ideal} + \dot{m}_{Leak},$$

where:

- \dot{m} is the actual mass flow rate.
- \dot{m}_{Ideal} is the ideal mass flow rate.
- \dot{m}_{Leak} is the internal leakage mass flow rate.

The torque generated at the motor is

$$\tau = \tau_{Ideal} - \tau_{Friction},$$

where:

- τ is the actual torque.
- τ_{Ideal} is the ideal torque.
- $\tau_{Friction}$ is the friction torque.

Ideal Flow Rate and Ideal Torque

The ideal mass flow rate is

$$\dot{m}_{Ideal} = \rho D \omega,$$

and the ideal generated torque is

$$\tau_{Ideal} = D \Delta p,$$

where:

- ρ is the average of the fluid densities at thermal liquid ports **A** and **B**.
- D is the **Displacement** parameter.

- ω is the shaft angular velocity.
- Δp is the pressure drop from inlet to outlet.

Leakage and friction parameterization

You can parameterize leakage and friction analytically, using tabulated efficiencies or losses, or by input efficiencies or input losses.

Analytical

When you set **Leakage and Friction Parameterization** to **Analytical**, the leakage flow rate is

$$\dot{m}_{\text{Leak}} = \frac{K_{\text{HP}}\rho_{\text{Avg}}\Delta p}{\mu_{\text{Avg}}},$$

and the friction torque is

$$\tau_{\text{Friction}} = \left(\tau_0 + K_{\text{TP}}|\Delta p| \tanh \frac{4\omega}{(5 \cdot 10^{-5})\omega_{\text{Nom}}} \right),$$

where:

- K_{HP} is the Hagen-Poiseuille coefficient for laminar pipe flows. This coefficient is computed from the specified nominal parameters.
- μ is the dynamic viscosity of the thermal liquid, taken here as the average of its values at the thermal liquid ports.
- K_{TP} is the friction torque vs. pressure gain coefficient at nominal displacement, which is determined from the **Mechanical efficiency at nominal conditions**, η_m :

$$k = \frac{\tau_{fr, \text{nom}} - \tau_0}{\Delta p_{\text{nom}}}.$$

τ_{fric} is the friction torque at nominal conditions:

$$\tau_{fr, \text{nom}} = (1 - \eta_{m, \text{nom}})D\Delta p_{\text{nom}}.$$

- τ_0 is the specified value of the **No-load torque** parameter.
- ω_{Nom} is the specified value of the **Nominal shaft angular velocity** parameter.
- Δp_{Nom} is the specified value of the **Nominal pressure drop** parameter. This is the pressure drop at which the nominal volumetric efficiency is specified.

The Hagen-Poiseuille coefficient is determined from nominal fluid and component parameters through the equation

$$K_{\text{HP}} = \frac{D\omega_{\text{Nom}}\mu_{\text{Nom}}\left(\frac{1}{\eta_{v, \text{Nom}}} - 1\right)}{\Delta p_{\text{Nom}}},$$

where:

- ω_{Nom} is the specified value of the **Nominal shaft angular velocity** parameter. This is the angular velocity at which the nominal volumetric efficiency is specified.

- μ_{Nom} is the specified value of the **Nominal Dynamic viscosity** block parameter. This is the dynamic viscosity at which the nominal volumetric efficiency is specified.
- $\eta_{\text{v,Nom}}$ is the specified value of the **Volumetric efficiency at nominal conditions** block parameter. This is the volumetric efficiency corresponding to the specified nominal conditions.

Tabulated Efficiencies

When you set **Leakage and friction parameterization** to Tabulated data - volumetric and mechanical efficiencies, the leakage flow rate is

$$\dot{m}_{\text{Leak}} = \dot{m}_{\text{Leak, Motor}} \frac{(1 + \alpha)}{2} + \dot{m}_{\text{Leak, Pump}} \frac{(1 - \alpha)}{2},$$

and the friction torque is

$$\tau_{\text{Friction}} = \tau_{\text{Friction, Motor}} \frac{1 + \alpha}{2} + \tau_{\text{Friction, Pump}} \frac{1 - \alpha}{2},$$

where:

- α is a numerical smoothing parameter for the motor-pump transition.
- $\dot{m}_{\text{Leak, Motor}}$ is the leakage flow rate in motor mode.
- $\dot{m}_{\text{Leak, Pump}}$ is the leakage flow rate in pump mode.
- $\tau_{\text{Friction, Motor}}$ is the friction torque in motor mode.
- $\tau_{\text{Friction, Pump}}$ is the friction torque in pump mode.

The smoothing parameter α is given by the hyperbolic function

$$\alpha = \tanh\left(\frac{4\Delta p}{\Delta p_{\text{Threshold}}}\right) \cdot \tanh\left(\frac{4\omega}{\omega_{\text{Threshold}}}\right) \cdot \tanh\left(\frac{4D}{D_{\text{Threshold}}}\right),$$

where:

- $\Delta p_{\text{Threshold}}$ is the specified value of the **Pressure drop threshold for motor-pump transition** block parameter.
- $\omega_{\text{Threshold}}$ is the specified value of the **Angular velocity threshold for motor-pump transition** block parameter.
- $D_{\text{Threshold}}$ is the specified value of the **Angular velocity threshold for motor-pump transition** block parameter.

The leakage flow rate is calculated from the volumetric efficiency, a quantity that is specified in tabulated form over the Δp - ω - D domain via the **Volumetric efficiency table** block parameter. When operating in motor mode (quadrants **1** and **3** of the Δp - ω - D chart shown in the "Operation Modes" on page 1-672 figure), the leakage flow rate is:

$$\dot{m}_{\text{Leak, Motor}} = (1 - \eta_{\text{v}})\dot{m},$$

where η_{v} is the volumetric efficiency, obtained either by interpolation or extrapolation of the tabulated data. Similarly, when operating in pump mode (quadrants **2** and **4** of the Δp - ω - D chart), the leakage flow rate is:

$$\dot{m}_{\text{Leak, Pump}} = -(1 - \eta_{\text{v}})\dot{m}_{\text{Ideal}}.$$

The friction torque is similarly calculated from the mechanical efficiency, a quantity that is specified in tabulated form over the Δp - ω - D domain via the **Mechanical efficiency table** block parameter. When operating in motor mode (quadrants **1** and **3** of the Δp - ω - D chart):

$$\tau_{\text{Friction, Motor}} = (1 - \eta_m)\tau_{\text{Ideal}},$$

where η_m is the mechanical efficiency, obtained either by interpolation or extrapolation of the tabulated data. Similarly, when operating in pump mode (quadrants **2** and **4** of the Δp - ω - D chart):

$$\tau_{\text{Friction, Pump}} = -(1 - \eta_m)\tau.$$

Tabulated Losses

When you set **Leakage and friction parameterization** to **Tabulated data - volumetric and mechanical losses**, the leakage (volumetric) flow rate is specified directly in tabulated form over the Δp - ω domain:

$$q_{\text{Leak}} = q_{\text{Leak}}(\Delta p, \omega).$$

The mass flow rate due to leakage is calculated from the volumetric flow rate:

$$\dot{m}_{\text{Leak}} = \rho q_{\text{Leak}}.$$

The friction torque is similarly specified in tabulated form:

$$\tau_{\text{Friction}} = \tau_{\text{Friction}}(\Delta p, \omega),$$

where $q_{\text{Leak}}(\Delta p, \omega)$ and $\tau_{\text{Friction}}(\Delta p, \omega)$ are the volumetric and mechanical losses, obtained through interpolation or extrapolation of the tabulated data specified via the **Volumetric loss table** and **Mechanical loss table** block parameters.

Input Efficiencies

When you set **Leakage and friction parameterization** to **Input signal - volumetric and mechanical efficiencies**, the leakage flow rate and friction torque calculations are identical to the **Tabulated data - volumetric and mechanical efficiencies** setting. The volumetric and mechanical efficiency lookup tables are replaced with physical signal inputs that you specify through ports **EV** and **EM**.

The efficiencies are positive quantities with value between 0 and 1. Input values outside of these bounds are set equal to the nearest bound (0 for inputs smaller than 0, 1 for inputs greater than 1). In other words, the efficiency signals are saturated at 0 and 1.

Input Losses

When you set **Leakage and friction parameterization** to **Input signal - volumetric and mechanical efficiencies**, the leakage flow rate and friction torque calculations are identical to the **Tabulated data - volumetric and mechanical efficiencies** setting. The volumetric and mechanical loss lookup tables are replaced with physical signal inputs that you specify through ports **LV** and **LM**.

The block ignores the sign of the input. The block sets the signs automatically from the operating conditions established during simulation—more precisely, from the Δp - ω quadrant in which the component happens to be operating.

Assumptions and Limitations

- The motor is treated as a quasi-steady component.
- The effects of fluid inertia and elevation are ignored.
- The motor wall is rigid.
- External leakage is ignored.

Ports

Input

EV — Volumetric efficiency, unitless

physical signal

Physical signal input port for the volumetric efficiency coefficient. The input signal has an upper bound at the **Maximum volumetric efficiency** parameter value and a lower bound at the **Minimum volumetric efficiency** parameter value.

Dependencies

To enable this port, set **Leakage and friction parameterization** to Input signal - volumetric and mechanical efficiencies.

EM — Mechanical efficiency, unitless

physical signal

Physical signal input port for the mechanical efficiency coefficient. The input signal has an upper bound at the **Maximum mechanical efficiency** parameter value and a lower bound at the **Minimum mechanical efficiency** parameter value.

Dependencies

To enable this port, set **Leakage and friction parameterization** to Input signal - volumetric and mechanical efficiencies.

LV — Volumetric loss, m³/s

physical signal

Physical signal input port for the volumetric loss, defined as the internal leakage flow rate between the motor inlets.

Dependencies

To enable this port, set **Leakage and friction parameterization** to Input signal - volumetric and mechanical losses.

LM — Mechanical loss, N*m

physical signal

Physical signal input port for the mechanical loss, defined as the friction torque on the rotating motor shaft.

Dependencies

To enable this port, set **Leakage and friction parameterization** to Input signal - volumetric and mechanical losses.

Conserving

A – Motor inlet

thermal liquid

Thermal liquid conserving port associated with the motor inlet.

B – Motor outlet

thermal liquid

Thermal liquid conserving port associated with the motor outlet.

C – Motor Case

mechanical rotational

Mechanical rotational conserving port associated with the motor case.

R – Motor Shaft

mechanical rotational

Mechanical rotational conserving port associated with the rotational motor shaft.

Parameters

Leakage and friction parameterization – Parameterization of leakage flow rate and friction torque

Analytical (default) | Tabulated data - volumetric and mechanical efficiencies | Tabulated data - volumetric and mechanical losses | Input signal - volumetric and mechanical efficiencies | Input signal - volumetric and mechanical losses

Method to compute flow-rate and torque losses due to internal leaks and friction. When you select **Analytical**, the block parameters are generally available from component data sheets. When you select **Tabulated data - volumetric and mechanical efficiencies** or **Tabulated data - volumetric and mechanical losses**, the block uses lookup tables to map pressure drop, angular velocity, and displacement to component efficiencies or losses.

When you select **Input signal - volumetric and mechanical efficiencies** or **Input signal - volumetric and mechanical losses**, the block performs the leakage flow rate and friction torque calculations the same as the **Tabulated data - volumetric and mechanical efficiencies** or **Tabulated data - volumetric and mechanical losses** settings, respectively, and the block enables the physical signal ports, **EV** and **EM**. You use these ports to specify the volumetric and mechanical efficiency.

Displacement – Fluid volume displaced per shaft rotation

30 cm³/rev (default) | positive scalar

Fluid volume displaced per shaft rotation. The block maintains this value throughout the simulation.

Nominal shaft angular velocity – Shaft angular velocity for given volumetric efficiency

188 rpm (default) | scalar

Angular velocity of the rotary shaft that corresponds to the given volumetric efficiency. These values are typically available at standard operating conditions in the manufacturer data sheet. The block uses this parameter to calculate the leakage flow rate and friction torque.

Dependencies

To enable this parameter, set **Leakage and friction parameterization** to Analytical.

Nominal pressure drop — Pressure drop for corresponding volumetric efficiency

10 MPa (default) | scalar

Pressure drop that corresponds to the given volumetric efficiency. These values are typically available at standard operating conditions in manufacturer data sheet. The block uses this parameter to calculate the internal leakage flow rate.

Dependencies

To enable this parameter, set **Leakage and friction parameterization** to Analytical.

Nominal dynamic viscosity — Dynamic viscosity at which to specify the volumetric efficiency

0.9 cP (default) | scalar

Dynamic viscosity of the hydraulic fluid for the given volumetric efficiency. These values are typically available at standard operating conditions in manufacturer data sheet. The block uses this parameter to calculate the internal leakage flow rate.

Dependencies

To enable this parameter, set **Leakage and friction parameterization** to Analytical.

Volumetric efficiency at nominal conditions — Volumetric efficiency at the specified nominal conditions

0.92 (default) | scalar in the range (0,1)

Volumetric efficiency for the given conditions. The block defines the volumetric efficiency as the ratio of actual to ideal volumetric flow rates. These values are typically available at standard operating conditions in manufacturer data sheet. The block uses this parameter to calculate the internal leakage flow rate.

Dependencies

To enable this parameter, set **Leakage and friction parameterization** to Analytical.

Mechanical efficiency at nominal conditions — Ratio of actual to ideal mechanical power

0.88 (default) | positive scalar

Ratio of actual mechanical power to ideal mechanical power at nominal conditions.

Dependencies

To enable this parameter, set **Leakage and friction parameterization** to Analytical.

No-load torque — Minimum torque required to induce shaft rotation

0 N*m (default) | scalar

Torque to overcome the seal friction and induce rotation of the mechanical shaft. This torque is the load-independent component of the total friction torque.

Dependencies

To enable this parameter, set **Leakage and friction parameterization** to Analytical.

Pressure drop vector for efficiencies, dp – Pressure drops for given volumetric and mechanical efficiencies

[.1, 1, 2] MPa (default) | vector

Pressure drops for the corresponding tabular efficiency data. The vector must be at least two elements in strictly increasing order.

You can specify the data for a single quadrant, $(\omega, \Delta p)$. Refer to the block description for the operation modes corresponding to the various quadrants.

Dependencies

To enable this parameter, set **Leakage and friction parameterization** to Tabulated data - volumetric and mechanical efficiencies.

Shaft angular velocity vector for efficiencies, w – Angular velocities at which to specify the volumetric and mechanical efficiencies

[25, 50, 100, 200, 300, 400] rad/s | vector

Shaft angular velocities for the corresponding tabular efficiency data. The vector must be at least two elements in strictly increasing order.

You can specify the data for a single quadrant, $(\omega, \Delta p)$. Refer to the block description for the operation modes corresponding to the various quadrants.

Dependencies

To enable this parameter, set **Leakage and friction parameterization** to Tabulated data - volumetric and mechanical efficiencies.

Volumetric efficiency table, $e_v(dp,w)$ – Volumetric efficiencies for given pressure drops and angular velocities

[.816, .908, .954, .977, .981, .984; .325, .663, .831, .916, .925, .946; .137, .568, .78, .892, .893, .91] | matrix

Volumetric efficiencies for the given fluid pressure drops, shaft angular velocities, and displacements. The efficiencies must be in the range (0,1]. M and N are the sizes of the specified lookup-table vectors:

- M is the number of vector elements in the **Pressure drop vector for efficiencies, dp** parameter.
- N is the number of vector elements in the **Shaft angular velocity vector for efficiencies, w** parameter.

You can specify the data for a single quadrant, $(\omega, \Delta p)$. Refer to the block description for the operation modes corresponding to the various quadrants.

Dependencies

To enable this parameter, set **Leakage and friction parameterization** to Tabulated data - volumetric and mechanical efficiencies.

Mechanical efficiency table, $e_m(dp,w)$ — Mechanical efficiencies for given pressure drops and angular velocities

[.996, .996, .996, .996, .996, .996; .988, .989, .989, .989, .989, .99; .981, .981, .982, .982, .983, .984] | matrix

Mechanical efficiencies for the given fluid pressure drops, shaft angular velocities, and displacements. The efficiencies must be in the range (0,1]. M and N are the sizes of the specified lookup-table vectors:

- M is the number of vector elements in the **Pressure drop vector for efficiencies, dp** parameter.
- N is the number of vector elements in the **Shaft angular velocity vector for efficiencies, w** parameter.

You can specify the data for a single quadrant, $(\omega, \Delta p)$. Refer to the block description for the operation modes corresponding to the various quadrants.

Dependencies

To enable this parameter, set **Leakage and friction parameterization** to Tabulated data - volumetric and mechanical efficiencies.

Pressure drop vector for losses, dp — Pressure drop for corresponding losses

[.1, 1, 2] MPa (default)

Pressure drops for the corresponding tabular efficiency data. The vector must be at least two elements in strictly increasing order.

You can specify the data for a single quadrant, $(\omega, \Delta p)$. Refer to the block description for the operation modes corresponding to the various quadrants.

Dependencies

To enable this parameter, set **Leakage and friction parameterization** to Tabulated data - volumetric and mechanical losses.

Shaft angular velocity vector for losses, w — Shaft speed for corresponding losses

[25, 50, 100, 200, 300, 400] rad/s (default)

Shaft angular velocity for the corresponding tabular efficiency data. The vector must be at least two elements in strictly increasing order.

You can specify the data for a single quadrant, $(\omega, \Delta p)$. Refer to the block description for the operation modes corresponding to the various quadrants.

Dependencies

To enable this parameter, set **Leakage and friction parameterization** to Tabulated data - volumetric and mechanical losses.

Volumetric loss table, $q_{loss}(dp,w)$ — Internal leakage flow rates for corresponding pressure drops and angular velocities

[.023, .023, .023, .023, .0285, .032; .0844, .0842, .0845, .084, .1125, .108; .1079, .108, .11, .108, .1605, .18] * $1e-3 \text{ m}^3/\text{s}$

Volumetric losses at the specified fluid pressure drops and shaft angular velocities. Volumetric loss is defined here as the internal leakage volumetric flow rate between port A and port B. M and N are the sizes of the specified lookup-table vectors:

- M is the number of vector elements in the **Pressure drop vector for losses, dp** parameter.
- N is the number of vector elements in the **Shaft angular velocity vector for losses, w** parameter.

You can specify the data for a single quadrant, $(\omega, \Delta p)$. Refer to the block description for the operation modes corresponding to the various quadrants.

Dependencies

To enable this parameter, set **Leakage and friction parameterization** to Tabulated data - volumetric and mechanical losses.

Mechanical loss table, torque_loss(dp,w) – Friction torques for the corresponding pressure drops and angular velocities

```
[.002, .002, .002, .002, .002, .002; .0607, .0556, .0556, .0556, .0556, .0505  
; .1937, .1937, .1833, .1833, .1729, .1626] N*m
```

Mechanical losses for the given pressure drops and shaft angular velocities. The block defines mechanical loss as the friction torque due to seals and internal components. M and N are the sizes of the specified lookup-table vectors:

- M is the number of vector elements in the **Pressure drop vector for losses, dp** parameter.
- N is the number of vector elements in the **Shaft angular velocity vector for losses, w** parameter.

You can specify the data for a single quadrant, $(\omega, \Delta p)$. Refer to the block description for the operation modes corresponding to the various quadrants. The tabulated data for the mechanical losses must obey the convention in the figure, with positive values at positive angular velocities and negative values at negative angular velocities.

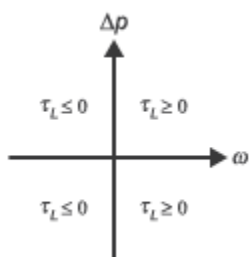

Dependencies

To enable this parameter, set **Leakage and friction parameterization** to Tabulated data - volumetric and mechanical losses.

Minimum volumetric efficiency – Lower saturation bound on the volumetric efficiency input signal

1e-3 (default) | scalar in the range (0,1)

Smallest allowed value of the volumetric efficiency. The input from the physical signal port **EV** saturates inputs below this value.

Dependencies

To enable this parameter, set **Leakage and friction parameterization** to Input signal - volumetric and mechanical efficiencies.

Maximum volumetric efficiency – Upper saturation bound on the volumetric efficiency input signal

1 (default) | scalar in the range (0,1)

Largest allowed value of the volumetric efficiency. The input from the physical signal port **EV** saturates inputs above this value.

Dependencies

To enable this parameter, set **Leakage and friction parameterization** to Input signal - volumetric and mechanical efficiencies.

Minimum mechanical efficiency – Lower saturation bound on the volumetric efficiency input signal

1e-3 (default) | scalar in the range (0,1)

Smallest allowed value of the mechanical efficiency. The input from the physical signal port **EM** saturates inputs below this value.

Dependencies

To enable this parameter, set **Leakage and friction parameterization** to Input signal - volumetric and mechanical efficiencies.

Maximum mechanical efficiency – Upper saturation bound on the volumetric efficiency input signal

1 (default) | scalar in the range (0,1)

Largest allowed value of the mechanical efficiency. The input from the physical signal port **EM** saturates inputs above this value.

Dependencies

To enable this parameter, set **Leakage and friction parameterization** to Input signal - volumetric and mechanical efficiencies.

Pressure drop threshold for motor-pump transition – Pressure drop at which to initiate a smooth transition between motor and pump modes

1e-3 MPa (default) | scalar

Pressure drop from inlet to outlet below which the block begins to transition between motoring and pumping modes. The block uses a hyperbolic tangent function to smooth the leakage flow rate and friction torque.

Dependencies

To enable this parameter, set **Leakage and friction parameterization** to Input signal - volumetric and mechanical efficiencies or Input signal - volumetric and mechanical losses.

Angular velocity threshold for motor-pump transition — Angular velocity at which to initiate a smooth transition between pump and motor modes

10 rad/s (default) | scalar

Shaft angular velocity below which the block begins to transition between motoring and pumping modes. The block uses the hyperbolic tangent function to smooth the leakage flow rate and friction torque.

Dependencies

To enable this parameter, set **Leakage and friction parameterization** to Input signal - volumetric and mechanical efficiencies or Input signal - volumetric and mechanical losses.

Cross-sectional area at ports A and B — Flow area at the component inlet and outlet0.01 m² (default) | positive scalar

Flow area at the component inlet and outlet. The areas are assumed equal.

Check if operating beyond the octants of supplied tabulated data — Simulation warning mode for operating conditions outside the range of tabulated data

None (default) | Warning

Simulation warning mode for operating conditions outside the range of tabulated data. Select **Warning** to be notified when the fluid pressure drop, shaft angular velocity, or instantaneous displacement cross outside the specified tabular data. The warning does not cause simulation to stop.

Dependencies

To enable this parameter, set **Leakage and friction parameterization** to:

- Tabulated data - volumetric and mechanical efficiencies
- Tabulated data - volumetric and mechanical losses
- Input signal - volumetric and mechanical efficiencies
- Input signal - volumetric and mechanical losses

Check if operating outside of motor mode — Simulation warning mode for operating conditions outside motoring mode

None (default) | Warning

Simulation warning mode for operating conditions outside the motoring mode. The block generates a warning if the motor transitions to pumping mode. Select **Warning** to be notified when this transition occurs. The warning does not cause simulation to stop.

Extended Capabilities**C/C++ Code Generation**

Generate C and C++ code using Simulink® Coder™.

See Also

Fixed-Displacement Pump (TL)

Introduced in R2016a

Fixed-Displacement Pump

Mechanical-to-hydraulic power conversion device

Library: Simscape / Fluids / Hydraulics (Isothermal) / Pumps and Motors

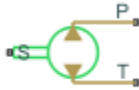

Description

The Fixed-Displacement Pump block represents a device that extracts power from a mechanical rotational network and delivers it to a hydraulic (isothermal liquid) network. The pump displacement is fixed at a constant value that you specify through the **Displacement** parameter.

Ports **T** and **P** represent the pump inlets. Port **S** represents the pump drive shaft. During normal operation, the pressure gain from port **T** to port **P** is positive if the angular velocity at port **S** is positive also. This operation mode is referred to here as *forward pump*.

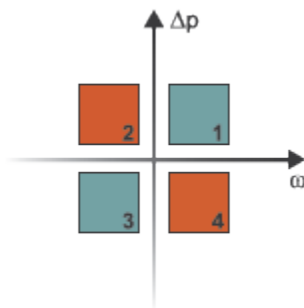

Operation Modes

A total of four operation modes are possible. The working mode depends on the pressure gain from port **T** to port **P** (Δp) and on the angular velocity at port **S** (ω). The “Operation Modes” on page 1-715 figure maps the modes to the quadrants of a Δp - ω chart. The modes are labeled 1-4:

- Mode **1**: forward pump — A positive shaft angular velocity generates a positive pressure gain.
- Mode **2**: reverse motor — A negative pressure drop (shown in the figure as a positive pressure gain) generates a negative shaft angular velocity.
- Mode **3**: reverse pump — A negative shaft angular velocity generates a negative pressure gain.
- Mode **4**: forward motor — A positive pressure drop (shown in the figure as a negative pressure gain) generates a positive shaft angular velocity.

The response time of the pump is considered negligible in comparison with the system response time. The pump is assumed to reach steady state nearly instantaneously and is treated as a quasi-steady component.

Block Variants and Loss Parameterizations

The pump model accounts for power losses due to leakage and friction. Leakage is internal and occurs between the pump inlet and outlet only. The block computes the leakage flow rate and friction torque using your choice of five loss parameterizations. You select a parameterization using block variants and, in the Analytical or tabulated data case, the **Friction and leakage parameterization** parameter.

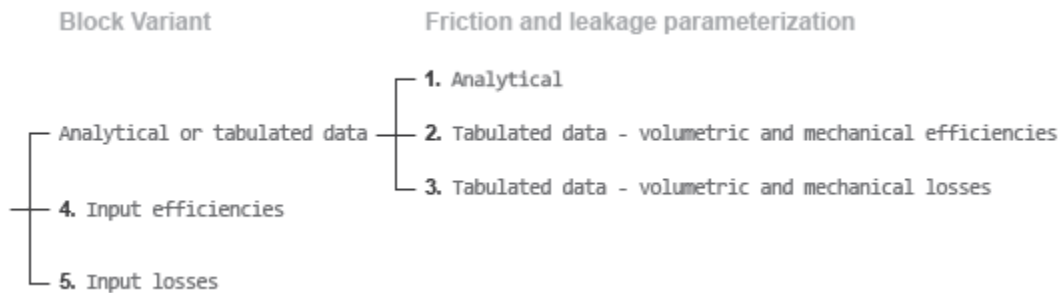

Loss Parameterizations

The block provides three Simulink variants to select from. To change the active block variant, right-click the block and select **Simscape > Block choices**. The available variants are:

- **Analytical or tabulated data** — Obtain the mechanical and volumetric efficiencies or losses from analytical models based on nominal parameters or from tabulated data. Use the **Friction and leakage parameterization** parameter to select the exact input type.
- **Input efficiencies** — Provide the mechanical and volumetric efficiencies directly through physical signal input ports.
- **Input losses** — Provide the mechanical and volumetric losses directly through physical signal input ports. The mechanical loss is defined as the internal friction torque. The volumetric loss is defined as the internal leakage flow rate.

Flow Rate and Driving Torque

The volumetric flow rate generated at the pump is

$$q = q_{\text{Ideal}} + q_{\text{Leak}}$$

where:

- q is the net volumetric flow rate.
- q_{Ideal} is the ideal volumetric flow rate.
- q_{Leak} is the internal leakage volumetric flow rate.

The driving torque required to power the pump is

$$\tau = \tau_{\text{Ideal}} + \tau_{\text{Friction}}$$

where:

- τ is the net driving torque.

- τ_{Ideal} is the ideal driving torque.
- τ_{Friction} is the friction torque.

Ideal Flow Rate and Ideal Torque

The ideal volumetric flow rate is

$$q_{\text{Ideal}} = D\omega,$$

and the ideal driving torque is

$$\tau_{\text{Ideal}} = D\Delta p,$$

where:

- D is the specified value of the **Displacement** block parameter.
- ω is the instantaneous angular velocity of the rotary shaft.
- Δp is the instantaneous pressure gain from inlet to outlet.

Leakage Flow Rate and Friction Torque

The internal leakage flow rate and friction torque calculations depend on the block variant selected. If the block variant is **Analytical** or **tabulated data**, the calculations depend also on the **Leakage and friction parameterization** parameter setting. There are five possible permutations of block variant and parameterization settings.

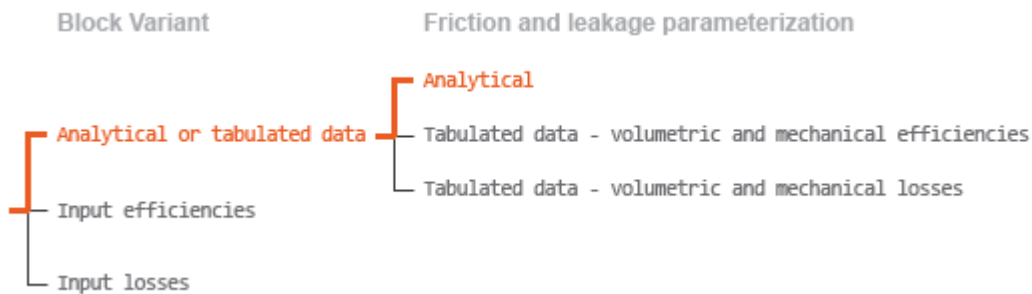

Case 1: Analytical Efficiency Calculation

If the active block variant is **Analytical** or **tabulated data** and the **Leakage and friction parameterization** parameter is set to **Analytical**, the leakage flow rate is

$$q_{\text{Leak}} = K_{\text{HP}}\Delta p,$$

and the friction torque is

$$\tau_{\text{Friction}} = (\tau_0 + K_{\text{TP}}|\Delta p|)\tanh\left(\frac{4\omega}{\omega_{\text{Threshold}}}\right),$$

where:

- K_{HP} is the Hagen-Poiseuille coefficient for laminar pipe flows. This coefficient is computed from the specified nominal parameters.

- K_{TP} is the specified value of the **Friction torque vs pressure gain coefficient** block parameter.
- τ_0 is the specified value of the **No-load torque** block parameter.
- $\omega_{Threshold}$ is the threshold angular velocity for the motor-pump transition. The threshold angular velocity is an internally set fraction of the specified value of the **Nominal shaft angular velocity** block parameter.

The Hagen-Poiseuille coefficient is determined from nominal fluid and component parameters through the equation

$$K_{HP} = \frac{\nu_{Nom} \rho_{Nom} \omega_{Nom} D_{Max}}{\rho v \Delta p_{Nom}} (1 - \eta_{v,Nom}),$$

where:

- ν_{Nom} is the specified value of the **Nominal kinematic viscosity** block parameter. This is the kinematic viscosity at which the nominal volumetric efficiency is specified.
- ρ_{Nom} is the specified value of the **Nominal fluid density** block parameter. This is the density at which the nominal volumetric efficiency is specified.
- ω_{Nom} is the specified value of the **Nominal shaft angular velocity** block parameter. This is the angular velocity at which the nominal volumetric efficiency is specified.
- ρ is the actual fluid density in the attached hydraulic (isothermal liquid) network. This density can differ from the specified value of the **Nominal fluid density** block parameter.
- v is the kinematic viscosity of the fluid associated with the fluid network.
- Δp_{Nom} is the specified value of the **Nominal pressure gain** block parameter. This is the pressure drop at which the nominal volumetric efficiency is specified.
- $\eta_{v,Nom}$ is the specified value of the **Volumetric efficiency at nominal conditions** block parameter. This is the volumetric efficiency corresponding to the specified nominal conditions.

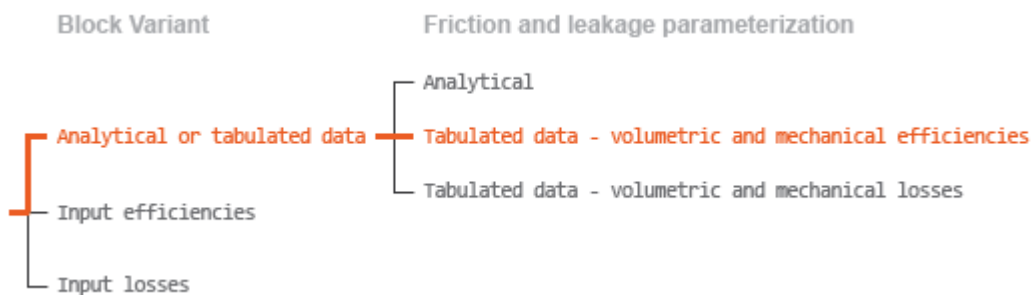

Case 2: Efficiency Tabulated Data

If the active block variant is **Analytical or tabulated data** and the **Leakage and friction parameterization** parameter is set to **Tabulated data – volumetric and mechanical efficiencies**, the leakage flow rate is

$$q_{Leak} = q_{Leak,Pump} \frac{(1 + \alpha)}{2} + q_{Leak,Motor} \frac{(1 - \alpha)}{2},$$

and the friction torque is

$$\tau_{Friction} = \tau_{Friction,Pump} \frac{1 + \alpha}{2} + \tau_{Friction,Motor} \frac{1 - \alpha}{2},$$

where:

- α is a numerical smoothing parameter for the pump-pump transition.
- $q_{\text{Leak,Pump}}$ is the leakage flow rate in pump mode.
- $q_{\text{Leak,Motor}}$ is the leakage flow rate in motor mode.
- $\tau_{\text{Friction,Pump}}$ is the friction torque in pump mode.
- $\tau_{\text{Friction,Motor}}$ is the friction torque in motor mode.

The smoothing parameter α is given by the hyperbolic function

$$\alpha = \tanh\left(\frac{4\Delta p}{\Delta p_{\text{Threshold}}}\right) \cdot \tanh\left(\frac{4\omega}{\omega_{\text{Threshold}}}\right),$$

where:

- $\Delta p_{\text{Threshold}}$ is the specified value of the **Pressure drop threshold for motor-pump transition** block parameter.
- $\omega_{\text{Threshold}}$ is the specified value of the **Angular velocity threshold for motor-pump transition** block parameter.

The leakage flow rate is computed from efficiency tabulated data through the equation

$$q_{\text{Leak,Pump}} = (1 - \eta_v)q_{\text{Ideal}},$$

in pump mode and through the equation

$$q_{\text{Leak,Motor}} = -(1 - \eta_v)q,$$

in motor mode, where:

- η_v is the volumetric efficiency obtained through interpolation or extrapolation of the **Volumetric efficiency table, e_v(dp,w)** parameter data.

Similarly, the friction torque is computed from efficiency tabulated data through the equation

$$\tau_{\text{Friction,Pump}} = (1 - \eta_m)\tau,$$

in pump mode and through the equation

$$\tau_{\text{Friction,Motor}} = -(1 - \eta_m)\tau_{\text{Ideal}},$$

in motor mode, where:

- η_m is the mechanical efficiency obtained through interpolation or extrapolation of the **Mechanical efficiency table, e_m(dp,w)** parameter data.

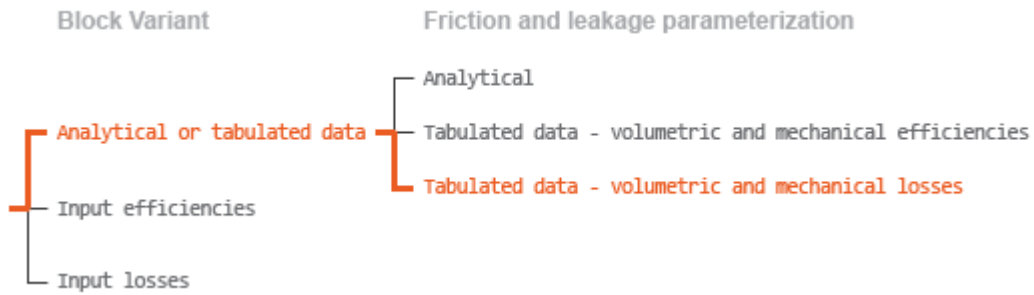

Case 3: Loss Tabulated Data

If the active block variant is Analytical or tabulated data and the **Leakage and friction parameterization** parameter is set to Tabulated data – volumetric and mechanical losses, the leakage flow rate equation is

$$q_{Leak} = q_{Leak}(\Delta p, \omega).$$

and the friction torque equation is

$$\tau_{Friction} = \tau_{Friction}(\Delta p, \omega),$$

where $q_{Leak}(\Delta p, \omega)$ and $\tau_{Friction}(\Delta p, \omega)$ are the volumetric and mechanical losses, obtained through interpolation or extrapolation of the **Volumetric loss table, q_loss(dp,w)** and **Mechanical loss table, torque_loss (dp,w)** parameter data.

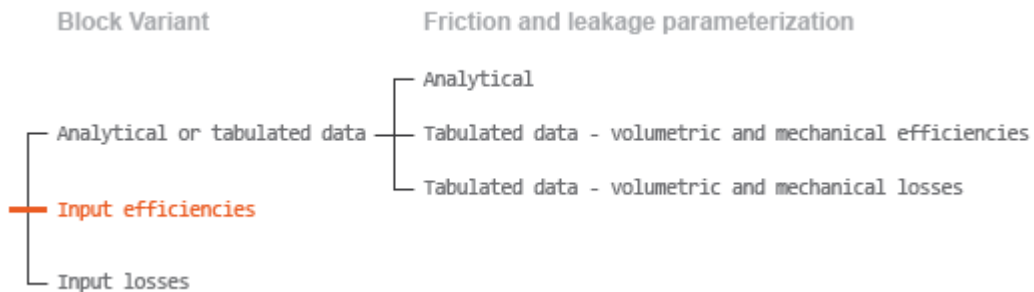

Case 4: Efficiency Physical Signal Inputs

If the active block variant is Input efficiencies, the leakage flow rate and friction torque calculations are as described for efficiency tabulated data (case 2). The volumetric and mechanical efficiency lookup tables are replaced with physical signal inputs that you specify through ports EV and EM.

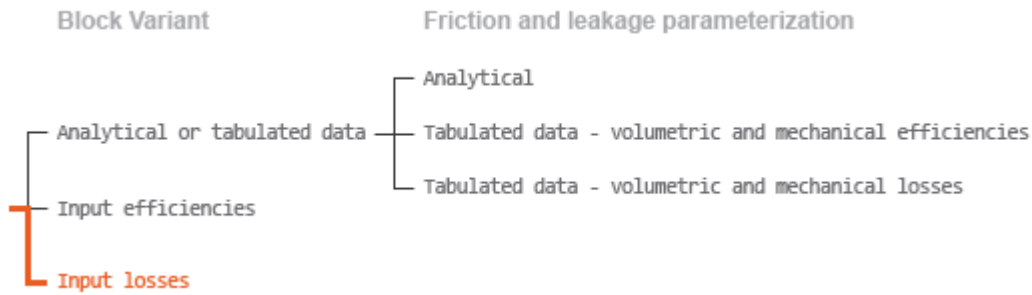

Case 5: Loss Physical Signal Inputs

If the block variant is `Input losses`, the leakage flow rate and friction torque calculations are as described for loss tabulated data (case 3). The volumetric and mechanical loss lookup tables are replaced with physical signal inputs that you specify through ports LV and LM.

Characteristic Curve Visualization

If the block variant is set to `Analytical or tabulated data`, you can plot a variety of performance, efficiency, and loss curves from simulation data and component parameters. Use the context-sensitive menu of the block to plot the characteristic curves. Right-click the block to open the menu and select **Fluids > Plot characteristic**. A test harness opens with instructions on how to generate the curves. See .

Assumptions

- Fluid compressibility is negligible.
- Loading on the pump shaft due to inertia, friction, and spring forces is negligible.

Ports

Input

EV — Volumetric efficiency, unitless

physical signal

Physical signal input port for the volumetric efficiency coefficient. The input signal has an upper bound at the **Maximum volumetric efficiency** parameter value and a lower bound at the **Minimum volumetric efficiency** parameter value.

Dependencies

This port is exposed only when the block variant is set to `Input efficiencies`.

EM — Mechanical efficiency, unitless

physical signal

Physical signal input port for the mechanical efficiency coefficient. The input signal has an upper bound at the **Maximum mechanical efficiency** parameter value and a lower bound at the **Minimum mechanical efficiency** parameter value.

Dependencies

This port is exposed only when the block variant is set to Input efficiencies.

LV – Volumetric loss, m³/s

physical signal

Physical signal input port for the volumetric loss, defined as the internal leakage flow rate between the pump inlets.

Dependencies

This port is exposed only when the block variant is set to Input losses.

LM – Mechanical loss, N*m

physical signal

Physical signal input port for the mechanical loss, defined as the friction torque on the rotating pump shaft.

Dependencies

This port is exposed only when the block variant is set to Input losses.

Conserving**P – Pump outlet**

hydraulic (isothermal liquid)

Hydraulic (isothermal liquid) conserving port representing the pump outlet.

T – Pump inlet

hydraulic (isothermal liquid)

Hydraulic (isothermal liquid) conserving port representing the pump inlet.

S – Pump shaft

mechanical rotational

Mechanical rotational conserving port representing the pump shaft.

Parameters

The exposed block parameters depend on the active block variant. See “Block Variants and Loss Parameterizations” on page 1-716.

Variant 1: Analytical or tabulated data**Displacement – Fluid volume displaced per unit shaft rotation angle**

30 cm³/rev (default) | scalar with units of volume/angle

Fluid volume displaced per unit shaft rotation angle. The displacement is fixed at this value during simulation. The specified value must be greater than zero.

Leakage and friction parameterization – Parameterization used to compute leakage flow rate and friction torque

Analytical (default)

Parameterization used to compute flow-rate and torque losses due to internal leaks and friction. The **Analytical** parameterization relies on nominal parameters generally available from component data sheets. The remaining, tabular, options rely on lookup tables to map pressure drop and angular velocity to component efficiencies or losses. The tabular options include:

- Tabulated data – volumetric and mechanical efficiencies
- Tabulated data – volumetric and mechanical losses

Dependencies

This parameter is enabled when the block variant is set to **Analytical** or **tabulated data**.

Nominal shaft angular velocity – Shaft angular velocity at which to specify the nominal volumetric efficiency

188 rad/s (default) | scalar with units of angle/time

Angular velocity of the rotating shaft at which the component's nominal volumetric efficiency is known. Nominal parameters are typically published for standard operating conditions in manufacturer's data sheets. The block uses this parameter to calculate, using simple linear functions, the leakage flow rate and friction torque.

Dependencies

This parameter is enabled when the block variant is set to **Analytical** or **tabulated data** and the **Leakage and friction parameterization** parameter is set to **Analytical**.

Nominal pressure gain – Pressure gain at which to specify the nominal volumetric efficiency

100e5 Pa (default) | scalar with units of pressure

Pressure gain from inlet to outlet at which the component's nominal volumetric efficiency is known. Nominal parameters are typically published for standard operating conditions in manufacturer's data sheets. The block uses this parameter to calculate, using a simple linear function, the internal leakage flow rate.

Dependencies

This parameter is enabled when the block variant is set to **Analytical** or **tabulated data** and the **Leakage and friction parameterization** parameter is set to **Analytical**.

Nominal kinematic viscosity – Kinematic viscosity at which to specify the nominal volumetric efficiency

18 cSt (default) | scalar with units of area/time

Kinematic viscosity of the hydraulic fluid at which the component's nominal volumetric efficiency is known. Nominal parameters are typically published for standard operating conditions in manufacturer's data sheets. The block uses this parameter to calculate, using a simple linear function, the internal leakage flow rate.

Dependencies

This parameter is enabled when the block variant is set to **Analytical** or **tabulated data** and the **Leakage and friction parameterization** parameter is set to **Analytical**.

Nominal fluid density — Fluid density at which to specify the nominal volumetric efficiency900 kg/m³ (default) | scalar with units of mass/volume

Mass density of the hydraulic fluid at which the component's nominal volumetric efficiency is known. Nominal parameters are typically published for standard operating conditions in manufacturer's data sheets. The block uses this parameter to calculate, using a simple linear function, the internal leakage flow rate.

Dependencies

This parameter is enabled when the block variant is set to Analytical or tabulated data and the **Leakage and friction parameterization** parameter is set to Analytical.

Volumetric efficiency at nominal conditions — Volumetric efficiency at the specified nominal conditions

0.92 (default) | unitless scalar between 0 and 1

Volumetric efficiency, defined as the ratio of actual to ideal volumetric flow rates, at the specified nominal conditions. Nominal parameters are typically published for standard operating conditions in manufacturer's data sheets. The block uses this parameter to calculate, using a simple linear function, the internal leakage flow rate.

Dependencies

This parameter is enabled when the block variant is set to Analytical or tabulated data and the **Leakage and friction parameterization** parameter is set to Analytical.

No-load torque — Minimum torque required to induce shaft rotation

0.05 N*m (default) | scalar with units of torque

Torque required to overcome seal friction and induce rotation of the mechanical shaft. This torque is the smoothed load-independent component of the total friction torque.

Dependencies

This parameter is enabled when the block variant is set to Analytical or tabulated data and the **Leakage and friction parameterization** parameter is set to Analytical.

Friction torque vs. pressure gain coefficient — Proportionality constant between friction torque and pressure gain

0.6e-6 N*m/Pa (default) | scalar with units of torque/pressure

Proportionality constant between the friction torque on the mechanical shaft and the pressure gain from inlet to outlet.

Dependencies

This parameter is enabled when the block variant is set to Analytical or tabulated data and the **Leakage and friction parameterization** parameter is set to Tabulated data – volumetric and mechanical efficiencies.

Check if lower side pressure violating minimum valid condition — Simulation warning mode for minimum valid pressure

None (default) | Warning

Simulation warning mode for invalid pressures at the component ports. Select `Warning` to be notified when pressure falls below a minimum specified value. The warning can be useful in models where pressure can fall below the saturated vapor pressure of the hydraulic fluid, causing cavitation to occur.

Minimum valid pressure — Pressure required to trigger simulation warning

0 (default) | scalar with units of pressure

Lower bound of the pressure validity range. A warning is issued if pressure falls below the specified value.

Dependencies

This parameter is enabled when the **Check if lower side pressure violating minimum valid condition** parameter is set to `Warning`.

Pressure gain vector for efficiencies, dp — Pressure gains at which to specify the volumetric and mechanical efficiencies

M -element vector with units of pressure (default)

M -element vector of pressure gains at which to specify the efficiency tabular data. The vector size, M , must be two or greater. The vector elements need not be uniformly spaced. However, they must monotonically increase in value from left to right.

Dependencies

This parameter is enabled when the block variant is set to `Analytical` or `tabulated data` and the **Leakage and friction parameterization** parameter is set to `Tabulated data – volumetric and mechanical efficiencies`.

Shaft angular velocity vector for efficiencies, w — Angular velocities at which to specify the volumetric and mechanical efficiencies

N -element vector with units of angular velocity (default)

N -element vector of shaft angular velocities at which to specify the efficiency tabular data. The vector size, N , must be two or greater. The vector elements need not be uniformly spaced. However, they must monotonically increase in value from left to right.

Dependencies

This parameter is enabled when the block variant is set to `Analytical` or `tabulated data` and the **Leakage and friction parameterization** parameter is set to `Tabulated data – volumetric and mechanical efficiencies`.

Volumetric efficiency table, $e_v(dp,w)$ — Volumetric efficiencies at the specified pressure gains and angular velocities

unitless M -by- N matrix

M -by- N matrix with the volumetric efficiencies at the specified fluid pressure gains and shaft angular velocities. The efficiencies must fall in the range of 0-1. M and N are the sizes of the specified lookup-table vectors:

- M is the number of vector elements in the **Pressure gain vector for efficiencies, dp** parameter.
- N is the number of vector elements in the **Shaft angular velocity vector for efficiencies, w** parameter.

Dependencies

This parameter is enabled when the block variant is set to `Analytical` or `tabulated data` and the **Leakage and friction parameterization** parameter is set to `Tabulated data – volumetric and mechanical efficiencies`.

Mechanical efficiency table, $e_m(dp,w)$ – Mechanical efficiencies at the specified pressure gains and angular velocities

unitless M -by- N matrix

M -by- N matrix with the mechanical efficiencies corresponding to the specified fluid pressure gains and shaft angular velocities. The efficiencies must fall in the range of 0-1. M and N are the sizes of the specified lookup-table vectors:

- M is the number of vector elements in the **Pressure gain vector for efficiencies, dp** parameter.
- N is the number of vector elements in the **Shaft angular velocity vector for efficiencies, w** parameter.

Dependencies

This parameter is enabled when the block variant is set to `Analytical` or `tabulated data` and the **Leakage and friction parameterization** parameter is set to `Tabulated data – volumetric and mechanical efficiencies`.

Pressure gain threshold for pump–motor transition – Pressure gain at which to initiate a smooth transition between pumping and motoring modes

$1e5$ Pa (default) | scalar with units of pressure

Pressure gain from inlet to outlet below which the component begins to transition between pumping and motoring modes. A hyperbolic Tanh function transforms the leakage flow rate and friction torque such that the transition is continuous and smooth.

Dependencies

This parameter is enabled when the block variant is set to `Input efficiencies` or when the block variant is set to `Analytical` or `tabulated data` and the **Leakage and friction parameterization** parameter is set to `Tabulated data – volumetric and mechanical efficiencies`.

Angular velocity threshold for pump–motor transition – Shaft angular velocity at which to initiate a smooth transition between pumping and motoring modes

10 rad/s (default) | scalar with units of angle/time

Shaft angular velocity below which the component begins to transition between pumping and motoring modes. A hyperbolic Tanh function transforms the leakage flow rate and friction torque such that the transition is continuous and smooth.

Dependencies

This parameter is enabled when the block variant is set to `Input efficiencies` or when the block variant is set to `Analytical` or `tabulated data` and the **Leakage and friction parameterization** parameter is set to `Tabulated data – volumetric and mechanical efficiencies`.

Check if operating beyond the quadrants of supplied tabulated data – Simulation warning mode for operating conditions outside the range of tabulated data

None (default) | Warning

Simulation warning mode for operating conditions outside the range of tabulated data. Select **Warning** to be notified when the fluid pressure gain or shaft angular velocity cross outside the specified tabular data. The warning does not cause simulation to stop.

Dependencies

This parameter is enabled when the block variant is set to **Analytical** or **tabulated data** and the **Leakage and friction parameterization** parameter is set to **Tabulated data – volumetric and mechanical efficiencies** or **Tabulated data – volumetric and mechanical losses**.

Pressure gain vector for losses, dp – Pressure gains at which to specify the volumetric and mechanical losses*M*-element vector with units of pressure (default)

M-element vector of pressure gains at which to specify the loss tabular data. The vector size, *M*, must be two or greater. The vector elements need not be uniformly spaced. However, they must monotonically increase in value from left to right.

Dependencies

This parameter is enabled when the block variant is set to **Analytical** or **tabulated data** and the **Leakage and friction parameterization** parameter is set to **Tabulated data – volumetric and mechanical losses**.

Shaft angular velocity vector for losses, w – Angular velocities at which to specify the volumetric and mechanical losses*N*-element vector with units of angle/time (default)

N-element vector of shaft angular velocities at which to specify the component loss data. The vector size, *N*, must be two or greater. The vector elements need not be uniformly spaced. However, they must monotonically increase in value from left to right.

Dependencies

This parameter is enabled when the block variant is set to **Analytical** or **tabulated data** and the **Leakage and friction parameterization** parameter is set to **Tabulated data – volumetric and mechanical losses**.

Volumetric loss table, q_loss(dp,w) – Internal leakage flow rates at the specified pressure gains and angular velocities*M*-by-*N* matrix with units of volume/time

M-by-*N* matrix with the volumetric gains at the specified fluid pressure gains and shaft angular velocities. Volumetric loss is defined here as the internal leakage volumetric flow rate between port A and port B. *M* and *N* are the sizes of the specified lookup-table vectors:

- *M* is the number of vector elements in the **Pressure gain vector for losses, dp** parameter.
- *N* is the number of vector elements in the **Shaft angular velocity vector for losses, w** parameter.

Dependencies

This parameter is enabled when the block variant is set to Analytical or tabulated data and the **Leakage and friction parameterization** parameter is set to Tabulated data – volumetric and mechanical losses.

Mechanical loss table, torque_loss(dp,w) – Friction torques at the specified pressure gains and angular velocities

M-by-*N* matrix with units of torque

M-by-*N* matrix with the mechanical losses at the specified fluid pressure gains and shaft angular velocities. Mechanical loss is defined here as the friction torque due to seals and internal components. *M* and *N* are the sizes of the specified lookup-table vectors:

- *M* is the number of vector elements in the **Pressure gain vector for losses, dp** parameter.
- *N* is the number of vector elements in the **Shaft angular velocity vector for losses, w** parameter.

Dependencies

This parameter is enabled when the block variant is set to Analytical or tabulated data and the **Leakage and friction parameterization** parameter is set to Tabulated data – volumetric and mechanical losses.

Variant 2: Input efficiencies**Pump Displacement – Fluid volume displaced per unit shaft rotation angle**

30 cm³/rev (default) | scalar with units of volume/angle

Fluid volume displaced per unit shaft rotation angle. The displacement is fixed at this value during simulation. The specified value must be greater than zero.

Pressure gain threshold for pump–motor transition – Pressure gain at which to initiate a smooth transition between motor and pump modes

1e5 Pa (default) | scalar with units of pressure

Pressure gain from inlet to outlet below which the component begins to transition between motoring and pumping modes. A hyperbolic Tanh function transforms the leakage flow rate and friction torque such that the transition is continuous and smooth.

Dependencies

This parameter is enabled when the block variant is set to Input efficiencies.

Angular velocity threshold for pump–motor transition – Shaft angular velocity at which to initiate a smooth transition between pump and motor modes

10 rad/s (default) | scalar with units of angle/time

Shaft angular velocity below which the component begins to transition between motoring and pumping modes. A hyperbolic Tanh function transforms the leakage flow rate and friction torque such that the transition is continuous and smooth.

Dependencies

This parameter is enabled when the block variant is set to Input efficiencies.

Minimum volumetric efficiency – Lower saturation bound on the volumetric efficiency input signal

1e-3 (default) | unitless scalar between 0 and 1

Smallest allowed value of the volumetric efficiency. The input from physical signal port EV saturates at the specified value. If the input signal falls below the minimum volumetric efficiency, the volumetric efficiency is set to the minimum volumetric efficiency.

Dependencies

This parameter is enabled when the block variant is set to Input efficiencies.

Maximum volumetric efficiency – Upper saturation bound on the volumetric efficiency input signal

1 (default) | unitless scalar between 0 and 1

Largest allowed value of the volumetric efficiency. The input from physical signal port EV saturates at the specified value. If the input signal rises above the maximum volumetric efficiency, the volumetric efficiency is set to the maximum volumetric efficiency.

Dependencies

This parameter is enabled when the block variant is set to Input efficiencies.

Minimum mechanical efficiency – Lower saturation bound on the volumetric efficiency input signal

1e-3 (default) | unitless scalar between 0 and 1

Smallest allowed value of the mechanical efficiency. The input from physical signal port EM saturates at the specified value. If the input signal falls below the minimum mechanical efficiency, the mechanical efficiency is set to the minimum mechanical efficiency.

Dependencies

This parameter is enabled when the block variant is set to Input efficiencies.

Maximum mechanical efficiency – Upper saturation bound on the volumetric efficiency input signal

1 (default) | unitless scalar between 0 and 1

Largest allowed value of the mechanical efficiency. The input from physical signal port EM saturates at the specified value. If the input signal rises above the maximum mechanical efficiency, the mechanical efficiency is set to the maximum mechanical efficiency.

Dependencies

This parameter is enabled when the block variant is set to Input efficiencies.

Check if lower side pressure violating minimum valid condition – Simulation warning mode for minimum valid pressure

None (default) | Warning

Simulation warning mode for invalid pressures at the component ports. Select Warning to be notified when pressure falls below a minimum specified value. The warning can be useful in models where pressure can fall below the saturated vapor pressure of the hydraulic fluid, causing cavitation to occur.

Minimum valid pressure — Pressure required to trigger simulation warning

0 (default) | scalar with units of pressure

Lower bound of the pressure validity range. A warning is issued if pressure falls below the specified value.

Dependencies

This parameter is enabled when the **Check if lower side pressure violating minimum valid condition** parameter is set to Warning.

Variant 3: Input losses**Pump Displacement — Fluid volume displaced per unit shaft rotation angle**

30 cm³/rev (default) | scalar with units of volume/angle

Fluid volume displaced per unit shaft rotation angle. The displacement is fixed at this value during simulation. The specified value must be greater than zero.

Check if operating beyond the pump mode — Simulation warning mode for operating conditions outside pumping mode

None (default) | Warning

Simulation warning mode for operating conditions outside the pumping mode. A warning is issued if the pump transitions to motoring mode. Select Warning to be notified when this transition occurs. The warning does not cause simulation to stop.

Dependencies

This parameter is enabled when the block variant is set to Input losses.

Check if lower side pressure violating minimum valid condition — Simulation warning mode for minimum valid pressure

None (default) | Warning

Simulation warning mode for invalid pressures at the component ports. Select Warning to be notified when pressure falls below a minimum specified value. The warning can be useful in models where pressure can fall below the saturated vapor pressure of the hydraulic fluid, causing cavitation to occur.

Minimum valid pressure — Pressure required to trigger simulation warning

0 (default) | scalar with units of pressure

Lower bound of the pressure validity range. A warning is issued if pressure falls below the specified value.

Dependencies

This parameter is enabled when the **Check if lower side pressure violating minimum valid condition** parameter is set to Warning.

Extended Capabilities**C/C++ Code Generation**

Generate C and C++ code using Simulink® Coder™.

See Also

Fixed-Displacement Motor | Variable-Displacement Pump | Variable-Displacement Motor | Fixed-Displacement Pump (TL) | Fixed-Displacement Motor (TL)

Topics

“Upgrading Simscape Fluids Models Containing Hydraulics (Isothermal) Blocks”

Introduced in R2006b

Fixed-Displacement Pump (IL)

Fixed-displacement pump in isothermal liquid system

Library: Simscape / Fluids / Isothermal Liquid / Pumps & Motors

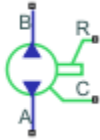

Description

The Fixed-Displacement Pump (IL) block models a pump with constant-volume displacement. The fluid may move from port **A** to port **B**, called *forward mode*, or from port **B** to port **A**, called *reverse mode*. Pump mode operation occurs when there is a pressure gain in the direction of the flow. Motor mode operation occurs when there is a pressure drop in the direction of the flow.

Shaft rotation corresponds to the sign of the fluid volume. Positive fluid displacement corresponds to positive shaft rotation in forward mode. Negative fluid displacement corresponds to negative shaft angular velocity in forward mode.

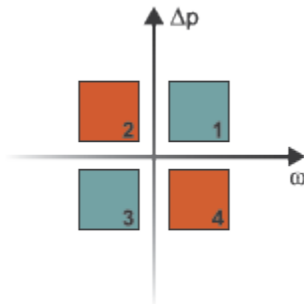

Operation Modes

The block has four modes of operation. The working mode depends on the pressure gain from port **A** to port **B**, $\Delta p = p_B - p_A$ and the angular velocity, $\omega = \omega_R - \omega_C$:

- Mode 1, *Forward Pump*: Positive shaft angular velocity causes a pressure increase from port **A** to port **B** and flow from port **A** to port **B**.
- Mode 2, *Reverse Motor*: Flow from port **B** to port **A** causes a pressure decrease from **B** to **A** and negative shaft angular velocity.
- Mode 3, *Reverse Pump*: Negative shaft angular velocity causes a pressure increase from port **B** to port **A** and flow from **B** to **A**.
- Mode 4, *Forward Motor*: Flow from port **A** to **B** causes a pressure decrease from **A** to **B** and positive shaft angular velocity.

The pump block has analytical, lookup table, and physical signal parameterizations. When using tabulated data or an input signal for parameterization, you can choose to characterize pump operation based on efficiency or losses.

The threshold parameters **Pressure gain threshold for pump-motor transition** and **Angular velocity threshold for pump-motor transition** identify regions where numerically smoothed flow transition between the pump operational modes can occur. For the pressure and angular velocity thresholds, choose a transition region that provides some margin for the transition term, but which is small enough relative to the typical pump pressure gain and angular velocity so that it will not impact calculation results.

Analytical Leakage and Friction Parameterization

If you set **Leakage and friction parameterization** to **Analytical**, the block calculates leakage and friction from constant values of shaft velocity, pressure gain, and friction torque. The leakage flow rate, which is correlated with the pressure differential over the pump, is calculated as:

$$\dot{m}_{leak} = K\rho_{avg}\Delta p,$$

where:

- Δp_{nom} is $p_B - p_A$.
- ρ_{avg} is the average fluid density.
- K is the Hagen-Poiseuille coefficient for analytical loss,

$$K = \frac{D\omega_{nom}(1 - \eta_{v, nom})}{\Delta p_{nom}},$$

where:

- D is the **Displacement**.
- ω_{nom} is the **Nominal shaft angular velocity**.
- $\eta_{v, nom}$ is the **Volumetric efficiency at nominal conditions**.
- Δp_{nom} is the **Nominal pressure gain**.

The friction torque, which is related to the pump pressure differential, is calculated as:

$$\tau_{fr} = (\tau_0 + k|\Delta p|)\tanh\left(\frac{4\omega}{5 \times 10^{-5}\omega_{nom}}\right),$$

where:

- τ_0 is the **No-load torque**.
- k is the friction torque vs. pressure gain coefficient at nominal displacement, which is determined from the **Mechanical efficiency at nominal conditions**, $\eta_{m, nom}$:

$$k = \frac{\tau_{fr, nom} - \tau_0}{\Delta p_{nom}}.$$

$\tau_{fr, nom}$ is the friction torque at nominal conditions:

$$\tau_{fr, nom} = \left(\frac{1 - \eta_{m, nom}}{\eta_{m, nom}}\right)D\Delta p_{nom}.$$

- ω is the relative shaft angular velocity, or $\omega_R - \omega_C$.

Tabulated Data Parameterizations

When using tabulated data for pump efficiencies or losses, you can provide data for one or more of the pump operational modes. The signs of the tabulated data determine the operational regime of the block. When data is provided for less than four operational modes, the block calculates the complementing data for the other mode(s) by extending the given data into the remaining quadrants.

The Tabulated data - volumetric and mechanical efficiencies parameterization

The leakage flow rate is calculated as:

$$\dot{m}_{leak} = \dot{m}_{leak, pump} \left(\frac{1 + \alpha}{2} \right) + \dot{m}_{leak, motor} \left(\frac{1 - \alpha}{2} \right),$$

where:

- $\dot{m}_{leak, pump} = (1 - \eta_v) \dot{m}_{ideal}$
- $\dot{m}_{leak, motor} = (\eta_v - 1) \dot{m}$

and η_v is the volumetric efficiency, which is interpolated from the user-provided tabulated data. The transition term, α , is

$$\alpha = \tanh\left(\frac{4\Delta p}{\Delta p_{threshold}}\right) \tanh\left(\frac{4\omega}{\omega_{threshold}}\right),$$

where:

- Δp is $p_B - p_A$.
- $p_{threshold}$ is the **Pressure gain threshold for pump-motor transition**.
- ω is $\omega_R - \omega_C$.
- $\omega_{threshold}$ is the **Angular velocity threshold for pump-motor transition**.

The friction torque is calculated as:

$$\tau_{fr} = \tau_{fr, pump} \left(\frac{1 + \alpha}{2} \right) + \tau_{fr, motor} \left(\frac{1 - \alpha}{2} \right),$$

where:

- $\tau_{fr, pump} = (1 - \eta_m) \tau$
- $\tau_{fr, motor} = (\eta_m - 1) \tau_{ideal}$

and η_m is the mechanical efficiency, which is interpolated from the user-provided tabulated data.

The Tabulated data - volumetric and mechanical losses parameterization

The leakage flow rate is calculated as:

$$\dot{m}_{leak} = \rho_{avg} q_{loss}(\Delta p, \omega),$$

where q_{loss} is interpolated from the **Volumetric loss table, $q_loss(dp, w)$** parameter, which is based on user-supplied data for pressure drop, shaft angular velocity, and fluid volumetric displacement.

The shaft friction torque is calculated as:

$$\tau_{fr} = \tau_{loss}(\Delta p, \omega),$$

where τ_{loss} is interpolated from the **Mechanical loss table, torque_loss(dp,w)** parameter, which is based on user-supplied data for pressure drop and shaft angular velocity.

Input Signal Parameterization

When you select **Input signal - volumetric and mechanical efficiencies**, ports **EV** and **EM** are enabled. The internal leakage and shaft friction are calculated in the same way as the **Tabulated data - volumetric and mechanical efficiencies** parameterization, except that η_v and η_m are received directly at ports **EV** and **EM**, respectively.

When you select **Input signal - volumetric and mechanical losses**, ports **LV** and **LM** are enabled. These ports receive leakage flow and friction torque as positive physical signals. The leakage flow rate is calculated as:

$$\dot{m}_{leak} = \rho_{avg} q_{LV} \tanh\left(\frac{4\Delta p}{p_{thresh}}\right),$$

where:

- q_{LV} is the leakage flow received at port **LV**.
- p_{thresh} is the **Pressure gain threshold for pump-motor transition** parameter.

The friction torque is calculated as:

$$\tau_{fr} = \tau_{LM} \tanh\left(\frac{4\omega}{\omega_{thresh}}\right),$$

where

- τ_{LM} is the friction torque received at port **LM**.
- ω_{thresh} is the **Angular velocity threshold for pump-motor transition** parameter.

The volumetric and mechanical efficiencies range between the user-defined specified minimum and maximum values. Any values lower or higher than this range will take on the minimum and maximum specified values, respectively.

Pump Operation

The pump flow rate is:

$$\dot{m} = \dot{m}_{ideal} - \dot{m}_{leak},$$

where $\dot{m}_{ideal} = \rho_{avg} D \cdot \omega$.

The pump torque is:

$$\tau = \tau_{ideal} + \tau_{fr},$$

where $\tau_{ideal} = D \cdot \Delta p$.

The mechanical power delivered by the pump shaft is:

$$\varphi_{mech} = \tau\omega,$$

and the pump hydraulic power is:

$$\varphi_{hyd} = \frac{\Delta p \dot{m}}{\rho_{avg}}.$$

If you would like to know if the block is operating beyond the supplied tabulated data, you can set **Check if operating beyond the quadrants of supplied tabulated data** to `Warning` to receive a warning if this occurs, or `Error` to stop the simulation when this occurs. For parameterization by input signal for volumetric or mechanical losses, you can be notified if the simulation surpasses operating modes with the **Check if operating beyond pump mode** parameter.

You can also monitor pump functionality. Set **Check if pressures are less than pump minimum pressure** to `Warning` to receive a warning if this occurs, or `Error` to stop the simulation when this occurs.

Predefined Parameterization

Pre-parameterization of the Fixed-Displacement Pump (IL) block with manufacturer data is available. This data allows you to model a specific supplier component.

To load a predefined parameterization,

- 1 Click the "Select a predefined parameterization" hyperlink in the Fixed-Displacement Pump (IL) block dialog description.
- 2 Select a part from the drop-down menu and click **Update block with selected part**.
- 3 If you change any parameter settings after loading a parameterization, you can check your changes by clicking **Compare block settings with selected part**. Any difference in settings between the block and pre-defined parameterization will display in the MATLAB command window.

Note Predefined parameterizations of Simscape components use available data sources for supplying parameter values. Engineering judgement and simplifying assumptions are used to fill in for missing data. As a result, deviations between simulated and actual physical behavior should be expected. To ensure requisite accuracy, you should validate simulated behavior against experimental data and refine component models as necessary.

Ports

Conserving

A – Liquid port

isothermal liquid

Liquid entry or exit port to the pump.

B – Liquid port

isothermal liquid

Liquid entry or exit port to the pump.

R – Mechanical port

mechanical rotational

Rotating shaft angular velocity and torque.

C – Mechanical port

mechanical rotational

Pump casing angular velocity and torque.

Input**EV – Volumetric efficiency**

physical signal

Pump efficiency for fluid displacement, specified as a physical signal. The value must be between 0 and 1.

Dependencies

To enable this port, set **Leakage and friction parameterization** to Input signal - volumetric and mechanical efficiencies.

EM – Mechanical efficiency

physical signal

Pump efficiency for the mechanical supply of energy, specified as a physical signal. The value must be between 0 and 1.

Dependencies

To enable this port, set **Leakage and friction parameterization** to Input signal - volumetric and mechanical efficiencies.

LV – Leakage flow rate, m³/s

physical signal

Pump volumetric losses in m³/s, specified as a physical signal.

Dependencies

To enable this port, set **Leakage and friction parameterization** to Input signal - volumetric and mechanical losses.

LM – Friction torque, N*m

physical signal

Pump mechanical losses in N*m, specified as a physical signal.

Dependencies

To enable this port, set **Leakage and friction parameterization** to Input signal - volumetric and mechanical losses.

Parameters

Leakage and friction parameterization — Method of calculating leakage flow rate and friction torque

Analytical (default) | Tabulated data - volumetric and mechanical efficiencies | Tabulated data - volumetric and mechanical losses | Input signal - volumetric and mechanical efficiencies | Input signal - volumetric and mechanical losses

Parameterization of the leakage and friction characteristics of the pump.

- In the **Analytical** parameterization, the leakage flow rate and the friction torque are calculated by analytical equations.
- In the **Tabulated data - volumetric and mechanical efficiencies** parameterization, the volumetric and mechanical efficiencies are calculated from the user-supplied **Pressure gain vector, dp** and **Shaft angular velocity vector, w** parameters and interpolated from the 2-D dependent **Volumetric efficiency table, $e_v(dp,w)$** and **Mechanical efficiency table, $e_m(dp,w)$** tables.
- In the **Tabulated data - volumetric and mechanical loss** parameterization, the leakage flow rate and friction torque are calculated from the user-supplied **Pressure gain vector, dp** and **Shaft angular velocity vector, w** parameters and interpolated from the 2-D dependent **Volumetric loss table, $q_{loss}(dp,w)$** and **Mechanical loss table, $torque_{loss}(dp,w)$** tables.
- In the **Input signal - volumetric and mechanical efficiencies** parameterization, the volumetric and mechanical efficiencies are received as physical signals at ports **EV** and **EM**, respectively.
- In the **Input signal - volumetric and mechanical loss** parameterization, the leakage flow rate and torque friction are received as physical signals at ports **LV** and **LM**, respectively.

Displacement — Fixed-volume fluid displacement

30 cm³/rev (default) | scalar

Amount of fluid displaced by shaft rotating under nominal or typical operating conditions.

Nominal shaft angular velocity — Shaft angular velocity

188 rad/s (default) | scalar

Angular velocity of the shaft under nominal operating conditions.

Dependencies

To enable this parameter, set **Leakage and friction parameterization** to **Analytical**.

Nominal pressure gain — Pressure gain between fluid entry and exit

10 MPa (default) | scalar

Pump pressure gain between the fluid entry and exit under nominal or typical operating conditions.

Dependencies

To enable this parameter, set **Leakage and friction parameterization** to **Analytical**.

Volumetric efficiency at nominal conditions — Ratio of actual flow rate to ideal flow rate

0.92 (default) | positive scalar in the range of (0,1]

Ratio of actual flow rate to ideal flow rate at nominal conditions.

Dependencies

To enable this parameter, set **Leakage and friction parameterization** to Analytical.

No-load torque – Baseline torque

0 N*m (default) | scalar

Minimum value of torque to overcome seal friction and induce shaft motion.

Dependencies

To enable this parameter, set **Leakage and friction parameterization** to Analytical.

Mechanical efficiency at nominal conditions – Ratio of actual torque to ideal torque generated

0.88 (default) | positive scalar

Ratio of actual torque to ideal torque generated at nominal conditions.

Dependencies

To enable this parameter, set **Leakage and friction parameterization** to Analytical.

Pressure gain vector, dp – Vector of pressure data for tabulated data parameterization

[.1, 1, 2] MPa (default) | 1-by-n vector

Vector of pressure differential values for the tabular parameterization of leakage and torque friction. This vector forms an independent axis with the **Shaft angular velocity vector, w** parameter for the 2-D dependent **Volumetric efficiency table, e_v(dp,w)** and **Mechanical efficiency table, e_m(dp,w,D)** parameters. The vector elements must be listed in ascending order.

Dependencies

To enable this parameter, set **Leakage and friction parameterization** to either:

- Tabulated data - volumetric and mechanical efficiencies
- Tabulated data - volumetric and mechanical losses

Shaft angular velocity vector, w – Vector of angular velocity data for tabulated data parameterization

[25, 50, 100, 200, 300, 400] rad/s (default) | 1-by-n vector

Vector of angular velocity data for the tabular parameterization of leakage and torque friction. This vector forms an independent axis with the **Shaft angular velocity vector, w** parameter for the 2-D dependent **Volumetric efficiency table, e_v(dp,w)** and **Mechanical efficiency table, e_m(dp,w)** parameters. The vector elements must be listed in ascending order.

Dependencies

To enable this parameter, set **Leakage and friction parameterization** to either:

- Tabulated data - volumetric and mechanical efficiencies
- Tabulated data - volumetric and mechanical losses

Volumetric efficiency table, $e_v(dp,w)$ — Volumetric efficiency for tabulated data parameterization

[.816, .908, .954, .977, .981, .984; .325, .663, .831, .916, .925, .946; .137, .568, .78, .892, .893, .91] (default) | M -by- N -by- P matrix

M -by- N matrix of volumetric efficiencies at the specified fluid pressure gain and shaft angular velocity. Linear interpolation is employed between table elements. M and N are the sizes of the correlated vectors:

- M is the number of vector elements in the **Pressure gain vector, dp** parameter.
- N is the number of vector elements in the **Shaft angular velocity vector, w** parameter.

Dependencies

To enable this parameter, set **Leakage and friction parameterization** to Tabulated data - volumetric and mechanical efficiencies.

Mechanical efficiency table, $e_m(dp,w)$ — Mechanical efficiency for tabulated data parameterization

[.996, .996, .996, .996, .996, .996; .988, .989, .989, .989, .989, .99; .981, .981, .982, .982, .983, .984] (default) | M -by- N -by- P matrix

M -by- N matrix of mechanical efficiencies at the specified fluid pressure gain and shaft angular velocity. Linear interpolation is employed between table elements. M and N are the sizes of the correlated vectors:

- M is the number of vector elements in the **Pressure gain vector, dp** parameter.
- N is the number of vector elements in the **Shaft angular velocity vector, w** parameter.

Dependencies

To enable this parameter, set **Leakage and friction parameterization** to Tabulated data - volumetric and mechanical efficiencies.

Volumetric loss table, $q_{loss}(dp,w)$ — Volumetric losses for tabulated data parameterization

[.023, .023, .023, .023, .0285, .032; .0844, .0842, .0845, .084, .1125, .108; .1079, .108, .11, .108, .1605, .18] * $1e-3$ m³/s (default) | M -by- N -by- P matrix

M -by- N matrix of volumetric efficiencies at the specified fluid pressure gain and shaft angular velocity. Linear interpolation is employed between table elements. M and N are the sizes of the correlated vectors:

- M is the number of vector elements in the **Pressure gain vector, dp** parameter.
- N is the number of vector elements in the **Shaft angular velocity vector, w** parameter.

Dependencies

To enable this parameter, set **Leakage and friction parameterization** to Tabulated data - volumetric and mechanical loss.

Mechanical loss table, $torque_{loss}(dp,w)$ — Mechanical losses for tabulated data parameterization

[.002, .002, .002, .002, .002, .002; .0607, .0556, .0556, .0556, .0556, .0505; .1937, .1937, .1833, .1833, .1729, .1626] N*m (default) | M -by- N -by- P matrix

M -by- N matrix of mechanical losses at the specified fluid pressure gain and shaft angular velocity. Linear interpolation is employed between table elements. M and N are the sizes of the correlated vectors:

- M is the number of vector elements in the **Pressure gain vector, dp** parameter.
- N is the number of vector elements in the **Shaft angular velocity vector, w** parameter.

Dependencies

To enable this parameter, set **Leakage and friction parameterization** to Tabulated data - volumetric and mechanical loss.

Minimum volumetric efficiency – Minimum value of volumetric efficiency

1e-3 (default) | positive scalar in the range of (0,1]

Minimum value of volumetric efficiency. If the input signal is below this value, the volumetric efficiency is set to the minimum volumetric efficiency.

Dependencies

To enable this parameter, set **Leakage and friction parameterization** to Input signal - volumetric and mechanical efficiencies.

Maximum volumetric efficiency – Maximum value of volumetric efficiency

1 (default) | positive scalar in the range of (0,1]

Maximum value of volumetric efficiency. If the input signal is above this value, the volumetric efficiency is set to the maximum volumetric efficiency.

Dependencies

To enable this parameter, set **Leakage and friction parameterization** to Input signal - volumetric and mechanical efficiencies.

Minimum mechanical efficiency – Minimum value of mechanical efficiency

1e-3 (default) | positive scalar in the range of (0,1]

Minimum value of mechanical efficiency. If the input signal is below this value, the mechanical efficiency is set to the minimum mechanical efficiency.

Dependencies

To enable this parameter, set **Leakage and friction parameterization** to Input signal - volumetric and mechanical efficiencies.

Maximum mechanical efficiency – Maximum value of mechanical efficiency

1 (default) | positive scalar in the range of (0,1]

Maximum value of mechanical efficiency. If the input signal is above this value, the mechanical efficiency is set to the maximum mechanical efficiency.

Dependencies

To enable this parameter, set **Leakage and friction parameterization** to Input signal - volumetric and mechanical efficiencies.

Pressure gain threshold for pump-motor transition – Pressure threshold for mode transition

1e-3 MPa (default) | positive scalar

Threshold pressure gain value for the transition between pump and motor functionality. A transition region is defined around 0 MPa between the positive and negative values of the pressure gain threshold. Within this transition region, the computed leakage flow rate and friction torque are adjusted according to the transition term α to ensure smooth transition from one mode to the other.

Dependencies

To enable this parameter, set **Leakage and friction parameterization** to either:

- Tabulated data - volumetric and mechanical efficiencies
- Input signal - volumetric and mechanical efficiencies
- Input signal - volumetric and mechanical losses

Angular velocity threshold for pump-motor transition – Angular velocity threshold for mode transition

10 rad/s (default) | positive scalar

Threshold angular velocity value for the transition between pump and motor functionality. A transition region is defined around 0 rad/s between the positive and negative values of the angular velocity threshold. Within this transition region, the computed leakage flow rate and friction torque are adjusted according to the transition term α to ensure smooth transition from one mode to the other.

Dependencies

To enable this parameter, set **Leakage and friction parameterization** to:

- Tabulated data - volumetric and mechanical efficiencies
- Input signal - volumetric and mechanical efficiencies
- Input signal - volumetric and mechanical losses

Check if operating beyond the quadrants of supplied tabulated data – Whether to notify if extents of supplied data are surpassed

None (default) | Warning | Error

Whether to notify if the extents of the supplied data are surpassed. Select Warning to be notified when the block uses values beyond the supplied data range. Select Error to stop the simulation when the block uses values beyond the supplied data range.

Dependencies

To enable this parameter, set **Leakage and friction parameterization** to:

- Tabulated data - volumetric and mechanical efficiencies
- Tabulated data - volumetric and mechanical losses

Check if operating outside of pump mode – Whether to notify if block operates outside of the pump mode functionality

None (default) | Warning | Error

Whether to notify if block operates outside of the pump mode functionality. This block has four operation modes: forward pump, reverse pump, reverse motor, and forward motor. Select **Warning** to be notified when the block operates in the forward or reverse motor modes. Select **Error** to stop the simulation when the block operates in the forward or reverse motor modes.

Dependencies

To enable this parameter, set **Leakage and friction parameterization** to `Input signal - volumetric and mechanical losses`.

Check if pressures are less than pump minimum pressure — Whether to notify if fluid exit pressure is low

None (default) | Warning | Error

Whether to notify if the fluid at port **A** or **B** experiences low pressure. Select **Warning** to be notified when the outlet pressure falls below a minimum specified value. Select **Error** to stop the simulation when the outlet pressure falls below a minimum specified value.

The parameter helps to identify potential conditions for cavitation, when the fluid pressure falls below the fluid vapor pressure.

Pump minimum pressure — Lower threshold to acceptable pressure at the pump outlet

0.101325 MPa (default) | positive scalar

Lower threshold of acceptable pressure at the pump inlet and outlet.

Dependencies

To enable this parameter, set **Check if pressures are less than pump minimum pressure** to:

- Warning
- Error

See Also

Variable-Displacement Pump (IL) | Fixed-Displacement Pump (TL) | Pressure-Compensated Pump (IL) | Fixed-Displacement Motor (IL)

Topics

Introduced in R2020a

Fixed-Displacement Pump (TL)

Mechanical-hydraulic power conversion device

Library: Simscape / Fluids / Thermal Liquid / Pumps & Motors



Description

The Fixed-Displacement Pump (TL) block represents a pump that extracts power from a mechanical rotational network and delivers it to a thermal liquid network. The pump displacement is fixed at a constant value that you specify through the **Displacement** parameter.

Ports **A** and **B** represent the pump inlets. Ports **R** and **C** represent the motor drive shaft and case. During normal operation, the pressure gain from port **A** to port **B** is positive if the angular velocity at port **R** relative to port **C** is positive also. This operation mode is referred to here as *forward pump*.

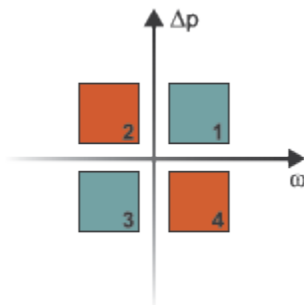

Operation Modes

The block has four modes of operation. The working mode depends on the pressure gain from port **A** to port **B**, $\Delta p = p_B - p_A$ and the angular velocity, $\omega = \omega_R - \omega_C$:

- Mode **1**, *Forward Pump*: Positive shaft angular velocity causes a pressure increase from port **A** to port **B** and flow from port **A** to port **B**.
- Mode **2**, *Reverse Motor*: Flow from port **B** to port **A** causes a pressure decrease from **B** to **A** and negative shaft angular velocity.
- Mode **3**, *Reverse Pump*: Negative shaft angular velocity causes a pressure increase from port **B** to port **A** and flow from **B** to **A**.
- Mode **4**, *Forward Motor*: Flow from port **A** to **B** causes a pressure decrease from **A** to **B** and positive shaft angular velocity.

The response time of the pump is considered negligible in comparison with the system response time. The pump is assumed to reach steady state nearly instantaneously and is treated as a quasi-steady component.

Energy Balance

Mechanical work done by the pump is associated with an energy exchange. The governing energy balance equation is

$$\phi_A + \phi_B + P_{hydro} = 0,$$

where

- Φ_A and Φ_B are energy flow rates at ports **A** and **B**, respectively.
- P_{hydro} is the pump hydraulic power. It is a function of the pressure difference between pump ports:

$$P_{hydro} = \Delta p \frac{\dot{m}}{\rho}.$$

The mechanical power is generated due to torque, τ , and angular velocity, ω :

$$P_{mech} = \tau\omega.$$

Flow Rate and Driving Torque

The mass flow rate generated at the pump is

$$\dot{m} = \dot{m}_{Ideal} - \dot{m}_{Leak},$$

where:

- \dot{m} is the actual mass flow rate.
- \dot{m}_{Ideal} is the ideal mass flow rate.
- \dot{m}_{Leak} is the internal leakage mass flow rate.

The driving torque required to power the pump is

$$\tau = \tau_{Ideal} + \tau_{Friction},$$

where:

- τ is the actual driving torque.
- τ_{Ideal} is the ideal driving torque.
- $\tau_{Friction}$ is the friction torque.

Ideal Flow Rate and Ideal Torque

The ideal mass flow rate is

$$\dot{m}_{Ideal} = \rho D\omega,$$

and the ideal generated torque is

$$\tau_{Ideal} = D\Delta p,$$

where:

- ρ is the average of the fluid densities at thermal liquid ports **A** and **B**.
- D is the **Displacement** parameter.

- ω is the shaft angular velocity.
- Δp is the pressure drop from inlet to outlet.

Leakage and Friction Parameterization

You can parameterize leakage and friction analytically, using tabulated efficiencies or losses, or by input efficiencies or input losses.

Analytical

When you set **Leakage and friction parameterization** to `Analytical`, the leakage flow rate is

$$\dot{m}_{\text{Leak}} = \frac{K_{\text{HP}}\rho_{\text{Avg}}\Delta p}{\mu_{\text{Avg}}},$$

and the friction torque is

$$\tau_{\text{Friction}} = \left(\tau_0 + K_{\text{TP}}|\Delta p| \tanh\left(\frac{4\omega}{(5 \cdot 10^{-5})\omega_{\text{Nom}}}\right) \right),$$

where:

- K_{HP} is the Hagen-Poiseuille coefficient for laminar pipe flows. This coefficient is computed from the specified nominal parameters.
- μ is the dynamic viscosity of the thermal liquid, taken here as the average of its values at the thermal liquid ports.
- K_{TP} is the friction torque vs. pressure gain coefficient at nominal displacement, which is determined from the **Mechanical efficiency at nominal conditions**, η_m :

$$k = \frac{\tau_{fr, nom} - \tau_0}{\Delta p_{nom}}.$$

$\tau_{fr, nom}$ is the friction torque at nominal conditions:

$$\tau_{fr, nom} = \left(\frac{1 - \eta_{m, nom}}{\eta_{m, nom}} \right) D \Delta p_{nom}.$$

- Δp_{Nom} is the specified value of the **Nominal pressure drop** block parameter. This is the pressure drop at which the nominal volumetric efficiency is specified.
- τ_0 is the specified value of the **No-load torque** parameter.
- ω_{Nom} is the specified value of the **Nominal shaft angular velocity** parameter.

The Hagen-Poiseuille coefficient is determined from nominal fluid and component parameters through the equation

$$K_{\text{HP}} = \frac{D\omega_{\text{Nom}}\mu_{\text{Nom}}(1 - \eta_{v, \text{Nom}})}{\Delta p_{\text{Nom}}},$$

where:

- ω_{Nom} is the specified value of the **Nominal shaft angular velocity** parameter. This is the angular velocity at which the nominal volumetric efficiency is specified.

- μ_{Nom} is the specified value of the **Nominal Dynamic viscosity** parameter. This is the dynamic viscosity at which the nominal volumetric efficiency is specified.
- $\eta_{v,\text{Nom}}$ is the specified value of the **Volumetric efficiency at nominal conditions** parameter. This is the volumetric efficiency corresponding to the specified nominal conditions.

Tabulated Efficiencies

When you set **Leakage and friction parameterization** to Tabulated data - volumetric and mechanical efficiencies, the leakage flow rate is

$$\dot{m}_{\text{Leak}} = \dot{m}_{\text{Leak, Motor}} \frac{(1 + \alpha)}{2} + \dot{m}_{\text{Leak, Pump}} \frac{(1 - \alpha)}{2},$$

and the friction torque is

$$\tau_{\text{Friction}} = \tau_{\text{Friction, Pump}} \frac{1 + \alpha}{2} + \tau_{\text{Friction, Motor}} \frac{1 - \alpha}{2},$$

where:

- α is a numerical smoothing parameter for the motor-pump transition.
- $\dot{m}_{\text{Leak, Motor}}$ is the leakage flow rate in motor mode.
- $\dot{m}_{\text{Leak, Pump}}$ is the leakage flow rate in pump mode.
- $\tau_{\text{Friction, Motor}}$ is the friction torque in motor mode.
- $\tau_{\text{Friction, Pump}}$ is the friction torque in pump mode.

The smoothing parameter α is given by the hyperbolic function

$$\alpha = \tanh\left(\frac{4\Delta p}{\Delta p_{\text{Threshold}}}\right) \cdot \tanh\left(\frac{4\omega}{\omega_{\text{Threshold}}}\right),$$

where:

- $\Delta p_{\text{Threshold}}$ is the specified value of the **Pressure drop threshold for motor-pump transition** parameter.
- $\omega_{\text{Threshold}}$ is the specified value of the **Angular velocity threshold for motor-pump transition** parameter.

The leakage flow rate is calculated from the volumetric efficiency, a quantity that is specified in tabulated form over the Δp - ω domain via the **Volumetric efficiency table** block parameter. When operating in pump mode (quadrants **1** and **3** of the Δp - ω chart shown in the “Operation Modes” on page 1-672 figure), the leakage flow rate is:

$$\dot{m}_{\text{Leak, Pump}} = (1 - \eta_v) \dot{m}_{\text{Ideal}},$$

where η_v is the volumetric efficiency, obtained either by interpolation or extrapolation of the tabulated data. Similarly, when operating in motor mode (quadrants **2** and **4** of the Δp - ω chart), the leakage flow rate is:

$$\dot{m}_{\text{Leak, Motor}} = -(1 - \eta_v) \dot{m}.$$

The friction torque is similarly calculated from the mechanical efficiency, a quantity that is specified in tabulated form over the Δp - ω domain via the **Mechanical efficiency table** block parameter. When operating in pump mode (quadrants **1** and **3** of the Δp - ω chart):

$$\tau_{\text{Friction,Pump}} = (1 - \eta_m)\tau,$$

where η_m is the mechanical efficiency, obtained either by interpolation or extrapolation of the tabulated data. Similarly, when operating in motor mode (quadrants **2** and **4** of the Δp - ω chart):

$$\tau_{\text{Friction,Motor}} = -(1 - \eta_m)\tau_{\text{Ideal}}.$$

Tabulated Losses

When you set **Leakage and friction parameterization** to **Tabulated data - volumetric and mechanical losses**, the leakage (volumetric) flow rate is specified directly in tabulated form over the Δp - ω domain:

$$q_{\text{Leak}} = q_{\text{Leak}}(\Delta p, \omega).$$

The mass flow rate due to leakage is calculated from the volumetric flow rate:

$$\dot{m}_{\text{Leak}} = \rho q_{\text{Leak}}.$$

The friction torque is similarly specified in tabulated form:

$$\tau_{\text{Friction}} = \tau_{\text{Friction}}(\Delta p, \omega),$$

where $q_{\text{Leak}}(\Delta p, \omega)$ and $\tau_{\text{Friction}}(\Delta p, \omega)$ are the volumetric and mechanical losses, obtained through interpolation or extrapolation of the tabulated data specified via the **Volumetric loss table** and **Mechanical loss table** block parameters.

Input Efficiencies

When you set **Leakage and friction parameterization** to **Input signal - volumetric and mechanical efficiencies**, the leakage flow rate and friction torque calculations are identical to the **Tabulated data - volumetric and mechanical efficiencies** setting. The volumetric and mechanical efficiency lookup tables are replaced with physical signal inputs that you specify through ports **EV** and **EM**.

The efficiencies are positive quantities with value between 0 and 1. Input values outside of these bounds are set equal to the nearest bound (0 for inputs smaller than 0, 1 for inputs greater than 1). In other words, the efficiency signals are saturated at 0 and 1.

Input Losses

When you set **Leakage and friction parameterization** to **Input signal - volumetric and mechanical efficiencies**, the leakage flow rate and friction torque calculations are identical to the **Tabulated data - volumetric and mechanical efficiencies** setting. The volumetric and mechanical loss lookup tables are replaced with physical signal inputs that you specify through ports **LV** and **LM**.

The block ignores the sign of the input. The block sets the signs automatically from the operating conditions established during simulation—more precisely, from the Δp - ω quadrant in which the component happens to be operating.

Assumptions and Limitations

- The pump is treated as a quasi-steady component.
- The effects of fluid inertia and elevation are ignored.

- The pump wall is rigid.
- External leakage is ignored.

Variables

Use the **Variables** tab to set the priority and initial target values for the block variables prior to simulation. For more information, see “Set Priority and Initial Target for Block Variables”.

Ports

Input

EV — Volumetric efficiency, unitless

physical signal

Physical signal input port for the volumetric efficiency coefficient. The input signal has an upper bound at the **Maximum volumetric efficiency** parameter value and a lower bound at the **Minimum volumetric efficiency** parameter value.

Dependencies

To enable this port, set **Leakage and friction parameterization** to Input signal - volumetric and mechanical efficiencies.

EM — Mechanical efficiency, unitless

physical signal

Physical signal input port for the mechanical efficiency coefficient. The input signal has an upper bound at the **Maximum mechanical efficiency** parameter value and a lower bound at the **Minimum mechanical efficiency** parameter value.

Dependencies

To enable this port, set **Leakage and friction parameterization** to Input signal - volumetric and mechanical efficiencies.

LV — Volumetric loss, m³/s

physical signal

Physical signal input port for the volumetric loss, defined as the internal leakage flow rate between the pump inlets.

Dependencies

To enable this port, set **Leakage and friction parameterization** to Input signal - volumetric and mechanical losses.

LM — Mechanical loss, N*m

physical signal

Physical signal input port for the mechanical loss, defined as the friction torque on the rotating pump shaft.

Dependencies

To enable this port, set **Leakage and friction parameterization** to Input signal - volumetric and mechanical losses.

Conserving

A – Pump inlet

thermal liquid

Thermal liquid conserving port associated with the pump inlet.

B – Pump outlet

thermal liquid

Thermal liquid conserving port associated with the pump outlet.

C – Pump Case

mechanical rotational

Mechanical rotational conserving port associated with the pump case.

R – Pump Shaft

mechanical rotational

Mechanical rotational conserving port associated with the rotational pump shaft.

Parameters

Leakage and friction parameterization – Parameterization of leakage flow rate and friction torque

Analytical (default) | Tabulated data - volumetric and mechanical efficiencies | Tabulated data - volumetric and mechanical losses | Input signal - volumetric and mechanical efficiencies | Input signal - volumetric and mechanical losses

Method to compute flow-rate and torque losses due to internal leaks and friction. When you select Analytical, the block parameters are generally available from component data sheets. When you select Tabulated data - volumetric and mechanical efficiencies or Tabulated data - volumetric and mechanical losses, the block uses lookup tables to map pressure drop, angular velocity, and displacement to component efficiencies or losses.

When you select Input signal - volumetric and mechanical efficiencies or Input signal - volumetric and mechanical losses, the block performs the leakage flow rate and friction torque calculations the same as the Tabulated data - volumetric and mechanical efficiencies or Tabulated data - volumetric and mechanical losses settings, respectively, and the block enables the physical signal ports, **EV** and **EM**. You use these ports to specify the volumetric and mechanical efficiency.

Displacement – Fluid volume displaced per shaft rotation

30 cm³/rev (default) | positive scalar

Fluid volume displaced per shaft rotation. The block maintains this value throughout the simulation.

Nominal shaft angular velocity – Shaft angular velocity for given volumetric efficiency

188 rpm (default) | scalar

Angular velocity of the rotary shaft that corresponds to the given volumetric efficiency. These values are typically available at standard operating conditions in the manufacturer data sheet. The block uses this parameter to calculate the leakage flow rate and friction torque.

Dependencies

To enable this parameter, set **Leakage and friction parameterization** to Analytical.

Nominal pressure drop – Pressure drop for corresponding volumetric efficiency

10 MPa (default) | scalar

Pressure drop that corresponds to the given volumetric efficiency. These values are typically available at standard operating conditions in manufacturer data sheet. The block uses this parameter to calculate the internal leakage flow rate.

Dependencies

To enable this parameter, set **Leakage and friction parameterization** to Analytical.

Nominal dynamic viscosity – Dynamic viscosity at which to specify the volumetric efficiency

0.9 cP (default) | scalar

Dynamic viscosity of the hydraulic fluid for the given volumetric efficiency. These values are typically available at standard operating conditions in manufacturer data sheet. The block uses this parameter to calculate the internal leakage flow rate.

Dependencies

To enable this parameter, set **Leakage and friction parameterization** to Analytical.

Volumetric efficiency at nominal conditions – Volumetric efficiency at the specified nominal conditions

0.92 (default) | scalar in the range (0,1)

Volumetric efficiency for the given conditions. The block defines the volumetric efficiency as the ratio of actual to ideal volumetric flow rates. These values are typically available at standard operating conditions in manufacturer data sheet. The block uses this parameter to calculate the internal leakage flow rate.

Dependencies

To enable this parameter, set **Leakage and friction parameterization** to Analytical.

Mechanical efficiency at nominal conditions – Ratio of actual to ideal mechanical power

0.88 (default) | positive scalar

Ratio of actual mechanical power to ideal mechanical power at nominal conditions.

Dependencies

To enable this parameter, set **Leakage and friction parameterization** to Analytical.

No-load torque – Minimum torque required to induce shaft rotation

0 N*m (default) | scalar

Torque to overcome the seal friction and induce rotation of the mechanical shaft. This torque is the load-independent component of the total friction torque.

Dependencies

To enable this parameter, set **Leakage and friction parameterization** to Analytical.

Pressure drop vector for efficiencies, dp — Pressure drops for given volumetric and mechanical efficiencies

[.1, 1, 2] MPa (default) | vector

Pressure drops for the corresponding tabular efficiency data. The vector must be at least two elements in strictly increasing order.

You can specify the data for a single quadrant, $(\omega, \Delta p)$. Refer to the block description for the operation modes corresponding to the various quadrants.

Dependencies

To enable this parameter, set **Leakage and friction parameterization** to Tabulated data - volumetric and mechanical efficiencies.

Shaft angular velocity vector for efficiencies, w — Angular velocities at which to specify the volumetric and mechanical efficiencies

[25, 50, 100, 200, 300, 400] rad/s | vector

Shaft angular velocities for the corresponding tabular efficiency data. The vector must be at least two elements in strictly increasing order.

You can specify the data for a single quadrant, $(\omega, \Delta p)$. Refer to the block description for the operation modes corresponding to the various quadrants.

Dependencies

To enable this parameter, set **Leakage and friction parameterization** to Tabulated data - volumetric and mechanical efficiencies.

Volumetric efficiency table, $e_v(dp,w)$ — Volumetric efficiencies for given pressure drops and angular velocities

[.816, .908, .954, .977, .981, .984; .325, .663, .831, .916, .925, .946; .137, .568, .78, .892, .893, .91] | matrix

Volumetric efficiencies for the given fluid pressure drops, shaft angular velocities, and displacements. The efficiencies must be in the range (0,1]. M and N are the sizes of the specified lookup-table vectors:

- M is the number of vector elements in the **Pressure drop vector for efficiencies, dp** parameter.
- N is the number of vector elements in the **Shaft angular velocity vector for efficiencies, w** parameter.

You can specify the data for a single quadrant, $(\omega, \Delta p)$. Refer to the block description for the operation modes corresponding to the various quadrants.

Dependencies

To enable this parameter, set **Leakage and friction parameterization** to Tabulated data - volumetric and mechanical efficiencies.

Mechanical efficiency table, $e_m(dp,w)$ — Mechanical efficiencies for given pressure drops and angular velocities

```
[.996, .996, .996, .996, .996, .996; .988, .989, .989, .989, .989, .99; .981, .981, .982, .982, .983, .984] | matrix
```

Mechanical efficiencies for the given fluid pressure drops, shaft angular velocities, and displacements. The efficiencies must be in the range (0,1]. M and N are the sizes of the specified lookup-table vectors:

- M is the number of vector elements in the **Pressure drop vector for efficiencies, dp** parameter.
- N is the number of vector elements in the **Shaft angular velocity vector for efficiencies, w** parameter.

You can specify the data for a single quadrant, $(\omega, \Delta p)$. Refer to the block description for the operation modes corresponding to the various quadrants.

Dependencies

To enable this parameter, set **Leakage and friction parameterization** to Tabulated data - volumetric and mechanical efficiencies.

Pressure drop vector for losses, dp — Pressure drop for corresponding losses

```
[.1, 1, 2] MPa (default)
```

Pressure drops for the corresponding tabular loss data. The vector must be at least two elements in strictly increasing order.

You can specify the data for a single quadrant, $(\omega, \Delta p)$. Refer to the block description for the operation modes corresponding to the various quadrants.

Dependencies

To enable this parameter, set **Leakage and friction parameterization** to Tabulated data - volumetric and mechanical losses.

Shaft angular velocity vector for losses, w — Shaft speed for corresponding losses

```
[25, 50, 100, 200, 300, 400] rad/s (default)
```

Shaft angular velocity for the corresponding tabular loss data. The vector must be at least two elements in strictly increasing order.

You can specify the data for a single quadrant, $(\omega, \Delta p)$. Refer to the block description for the operation modes corresponding to the various quadrants.

Dependencies

To enable this parameter, set **Leakage and friction parameterization** to Tabulated data - volumetric and mechanical losses.

Volumetric loss table, $q_{loss}(dp,w)$ — Internal leakage flow rates for corresponding pressure drops and angular velocities

```
[.023, .023, .023, .023, .0285, .032; .0844, .0842, .0845, .084, .1125, .108; .1079, .108, .11, .108, .1605, .18] * 1e-3 m^3/s
```

Volumetric losses at the specified fluid pressure drops and shaft angular velocities. Volumetric loss is defined here as the internal leakage volumetric flow rate between port A and port B. M and N are the sizes of the specified lookup-table vectors:

- M is the number of vector elements in the **Pressure drop vector for losses, dp** parameter.
- N is the number of vector elements in the **Shaft angular velocity vector for losses, w** parameter.

You can specify the data for a single quadrant, $(\omega, \Delta p)$. Refer to the block description for the operation modes corresponding to the various quadrants.

Dependencies

To enable this parameter, set **Leakage and friction parameterization** to Tabulated data - volumetric and mechanical losses.

Mechanical loss table, torque_loss(dp,w) – Friction torques for the corresponding pressure drops and angular velocities

```
[.002, .002, .002, .002, .002, .002; .0607, .0556, .0556, .0556, .0556, .0505  
; .1937, .1937, .1833, .1833, .1729, .1626] N*m
```

Mechanical losses for the given pressure drops and shaft angular velocities. The block defines mechanical loss as the friction torque due to seals and internal components. M and N are the sizes of the specified lookup-table vectors:

- M is the number of vector elements in the **Pressure drop vector for losses, dp** parameter.
- N is the number of vector elements in the **Shaft angular velocity vector for losses, w** parameter.

You can specify the data for a single quadrant, $(\omega, \Delta p)$. Refer to the block description for the operation modes corresponding to the various quadrants. The tabulated data for the mechanical losses must obey the convention in the figure, with positive values at positive angular velocities and negative values at negative angular velocities.

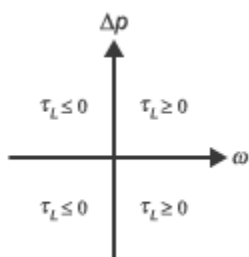

Dependencies

To enable this parameter, set **Leakage and friction parameterization** to Tabulated data - volumetric and mechanical losses.

Minimum volumetric efficiency – Lower saturation bound on the volumetric efficiency input signal

1e-3 (default) | scalar in the range (0,1)

Smallest allowed value of the volumetric efficiency. The input from the physical signal port **EV** saturates inputs below this value.

Dependencies

To enable this parameter, set **Leakage and friction parameterization** to Input signal - volumetric and mechanical efficiencies.

Maximum volumetric efficiency – Upper saturation bound on the volumetric efficiency input signal

1 (default) | scalar in the range (0,1)

Largest allowed value of the volumetric efficiency. The input from the physical signal port **EV** saturates inputs above this value.

Dependencies

To enable this parameter, set **Leakage and friction parameterization** to Input signal - volumetric and mechanical efficiencies.

Minimum mechanical efficiency – Lower saturation bound on the volumetric efficiency input signal

1e-3 (default) | scalar in the range (0,1)

Smallest allowed value of the mechanical efficiency. The input from the physical signal port **EM** saturates inputs below this value.

Dependencies

To enable this parameter, set **Leakage and friction parameterization** to Input signal - volumetric and mechanical efficiencies.

Maximum mechanical efficiency – Upper saturation bound on the volumetric efficiency input signal

1 (default) | scalar in the range (0,1)

Largest allowed value of the mechanical efficiency. The input from the physical signal port **EM** saturates inputs above this value.

Dependencies

To enable this parameter, set **Leakage and friction parameterization** to Input signal - volumetric and mechanical efficiencies.

Pressure drop threshold for motor-pump transition – Pressure drop at which to initiate a smooth transition between motor and pump modes

1e-3 MPa (default) | scalar

Pressure drop from inlet to outlet below which the block begins to transition between motoring and pumping modes. The block uses a hyperbolic tangent function to smooth the leakage flow rate and friction torque.

Dependencies

To enable this parameter, set **Leakage and friction parameterization** to Input signal - volumetric and mechanical efficiencies or Input signal - volumetric and mechanical losses.

Angular velocity threshold for motor-pump transition — Angular velocity at which to initiate a smooth transition between pump and motor modes

10 rad/s (default) | scalar

Shaft angular velocity below which the block begins to transition between motoring and pumping modes. The block uses the hyperbolic tangent function to smooth the leakage flow rate and friction torque.

Dependencies

To enable this parameter, set **Leakage and friction parameterization** to Input signal - volumetric and mechanical efficiencies or Input signal - volumetric and mechanical losses.

Cross-sectional area at ports A and B — Flow area at the component inlet and outlet0.01 m² (default) | positive scalar

Flow area at the component inlet and outlet. The areas are assumed equal.

Check if operating beyond the octants of supplied tabulated data — Simulation warning mode for operating conditions outside the range of tabulated data

None (default) | Warning

Simulation warning mode for operating conditions outside the range of tabulated data. Select **Warning** to be notified when the fluid pressure drop, shaft angular velocity, or instantaneous displacement cross outside the specified tabular data. The warning does not cause simulation to stop.

Dependencies

To enable this parameter, set **Leakage and friction parameterization** to:

- Tabulated data - volumetric and mechanical efficiencies
- Tabulated data - volumetric and mechanical losses
- Input signal - volumetric and mechanical efficiencies
- Input signal - volumetric and mechanical losses

Check if operating outside of motor mode — Simulation warning mode for operating conditions outside motoring mode

None (default) | Warning

Simulation warning mode for operating conditions outside the motoring mode. The block generates a warning if the motor transitions to pumping mode. Select **Warning** to be notified when this transition occurs. The warning does not cause simulation to stop.

Extended Capabilities**C/C++ Code Generation**

Generate C and C++ code using Simulink® Coder™.

See Also

Centrifugal Pump (TL) | Fixed-Displacement Motor (TL) | Variable-Displacement Pump (TL)

Introduced in R2016a

Flow Coefficient Parameterized Valve (TL)

Valve with flow area modeled in terms of its Cv or Kv flow coefficient

Library: Simscape / Fluids / Thermal Liquid / Valves & Orifices



Description

The Flow Coefficient Parameterized Valve (TL) block models the flow characteristics of a valve using the flow coefficient as a means to relate the flow rate through the ports to the pressure drop across them. The flow coefficient parameterization suits those cases in which the internal geometry of a valve is known in poor detail or in which the flow coefficient is the preferred means of characterizing a valve. The valve model is sufficiently general in its assumptions that it can be applied to a variety of valves; no single valve type is assumed in this block.

Flow Coefficient Parameterization

The flow coefficient measures the ease with which a fluid driven by a pressure differential flows across a valve. It is an important parameter in the sizing of valves and a convenient way of characterizing one in a model. In this role it is especially useful, as it quantifies in a single number all of the losses incurred in the flow passages of the valve. The flow coefficient is typically measured by the valve manufacturer and reported in a data sheet provided for the valve.

Strictly speaking there are two flow coefficients in common use: C_v and K_v . These describe what is fundamentally the same quantity: the volumetric flow rate of water passing through a valve that has been opened to its maximum and set to some standard operating conditions. The flow coefficients differ only in the temperature and pressure drop established during the measurement (the operating conditions) and in the physical units used in its expression:

- C_v is measured at a generally accepted temperature of 60 °F and pressure drop of 1 PSI; it is expressed in imperial units of US gpm. This is the flow coefficient used in the model when the **Flow coefficient specification** block parameter is set to Cv coefficient (USG/min) [1 on page 1-764].
- K_v is measured at a generally accepted temperature of 15 °C and pressure drop of bar; it is expressed in metric units of m³/h. This is the flow coefficient used in the model when the **Flow coefficient specification** block parameter is set to Kv coefficient (m³/h). [2 on page 1-764].

Two values are required of the flow coefficient, a *maximum* and a *minimum*. The maximum corresponds to a valve open to full capacity; this is the value frequently reported in valve data sheets. The minimum corresponds to a valve closed tight, when only leakage flow remains, if any at all. This lower bound imposed on the flow coefficient serves primarily to ensure the numerical robustness of the model. Its exact value is less important than its being a (generally very small) number greater than zero.

Valve Opening Parameterization

The opening fraction of the valve (the ratio of the valve opening area to its maximum value) is determined during simulation from the input specified at port L. This input is the *control signal* and it

is, in some valves, associated with *stroke* or *lift percent*. The control signal can range in value from θ to 1. If a lesser or greater value is specified, it is adjusted to the nearest of the two limits. In other words, the signal is *saturated* at θ and 1.

The conversion from control signal to opening fraction depends on the **Valve opening characteristics** parameterization selected in the block. The calculation result is the same for all parameterizations when the control signal is either θ or 1: a value of θ at port **L** always means a maximally (though not necessarily *completely*) closed valve; a value of 1 always means a maximally open valve. At intermediate values, the opening fractions differ:

- **Linear** — The valve opening fraction (denoted $f(L)$ in the figure) is equal to the control signal at port **L**. The two vary in tandem until the control signal either drops below zero (the valve is fully closed) or rises above its maximum value (the valve is fully open). The opening fraction ranges from θ to 1 (a statement that does not apply to all valve opening parameterizations).

$$f(L) = L.$$

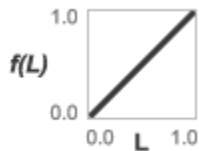

- **Quick opening** — The valve opening fraction, $f(L)$, is a power function of the control signal at port **L**. The opening fraction rises quickly with the control signal at values near θ and slowly at values near 1. The exponent (α) in the calculation determines how the opening rate changes with the control signal. The opening fraction ranges from θ to 1.

$$f(L) = L^{1/\alpha}, \quad \alpha > 1.$$

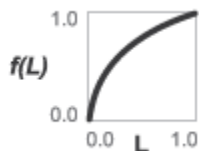

- **Equal percentage** — The valve opening fraction is an exponential function of the control signal at port **L**. The opening fraction rises slowly with the control signal at values near θ and quickly at values near 1. The base of the exponent (R , the *rangeability* of the valve, the ratio between the maximum and minimum flow rates through the ports) determines how the opening rate changes with the control signal. The opening fraction ranges from a small fraction ($\theta .02$ – $\theta .05$ for typical rangeability values of 20–50) to 1.

$$f(L) = R^{L-1}, \quad R \approx 20 - 50.$$

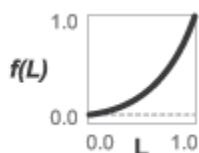

Mass Balance

The volume of fluid inside the valve, and therefore the mass of the same, is assumed to be very small and it is, for modeling purposes, ignored. As a result, no amount of fluid can accumulate there. By the principle of conservation of mass, the mass flow rate into the valve through one port must therefore equal that out of the valve through the other port:

$$\dot{m}_A + \dot{m}_B = 0,$$

where \dot{m} is defined as the mass flow rate *into* the valve through the port indicated by the subscript (**A** or **B**).

Momentum Balance

The causes of those pressure losses incurred in the passages of the valve are ignored in the block. Whatever their natures—sudden area changes, flow passage contortions—only their cumulative effect is considered during simulation. It is this cumulative effect that the flow coefficient of the valve enables the block to capture in a model. This constant factors in the momentum balance of the valve *indirectly*, by way of the effective opening area (S) of the same:

$$p_A - p_B = \frac{\dot{m}\sqrt{\dot{m}^2 + \dot{m}_{cr}^2}}{\rho_{avg}S^2},$$

where:

- p is the pressure at the port indicated by the subscript (**A** or **B**).
- ρ_{avg} is the arithmetic mean of the fluid densities at the ports.
- \dot{m} is the mass flow rate at a port.
- \dot{m}_{cr} is the critical mass flow rate, that at which the flow is assumed to switch between laminar and turbulent regimes:

$$\dot{m}_{cr} = Re_{cr}\mu_{avg}\sqrt{\frac{\pi}{4}}S,$$

where Re_{cr} is the Reynolds number at the transition point and μ_{avg} is the average of the dynamic viscosities at the ports.

The effective opening area (S) is the product of scaling of the maximum opening area of the valve by the opening fraction ($f(L)$). The calculation imposes a lower bound on the opening area at which only leakage flow remains:

$$S(L) = \begin{cases} S_{max}f(L), & \text{if } S_{max}f(L) > S_{min} \\ S_{min}, & \text{else} \end{cases},$$

where the subscripts **max** and **min** refer to a valve in the fully opened and maximally closed positions; the function $f(L)$ is the opening fraction calculated from the control signal specified at port **L**:

$$f(L) = \begin{cases} L, & \text{Linear parameterization} \\ L^{1/\alpha}, & \text{Quick opening parameterization} \\ R^L - 1, & \text{Equal percentages parameterization} \end{cases},$$

where α is obtained from the **Exponent number** block parameter and R from the **Rangeability** parameter. The maximum opening area is obtained by multiplying the (maximum) flow coefficient by an appropriate conversion factor:

$$S_{\text{Max}} = \begin{cases} \lambda_C C_{v,\text{max}}, & \text{if } C_v \text{ is used} \\ \lambda_K K_{v,\text{max}}, & \text{if } K_v \text{ is used} \end{cases}$$

where:

- λ_C is the conversion factor between the maximum flow coefficient in imperial units ($C_{v,\text{max}}$) and the maximum opening area: $2.4015 \times 10^{-5} \text{ m}^2$.
- λ_K is the conversion factor between the maximum flow coefficient in SI units ($K_{v,\text{max}}$) and the maximum opening area: $2.7765 \times 10^{-5} \text{ m}^2$.

The minimum opening area in turn is obtained by multiplying the maximum opening area by the ratio between minimum and maximum flow coefficients:

$$S_{\text{Min}} = \begin{cases} \frac{C_{v,\text{min}}}{C_{v,\text{max}}} S_{\text{max}}, & \text{if } C_v \text{ is used} \\ \frac{K_{v,\text{min}}}{K_{v,\text{max}}} S_{\text{max}}, & \text{if } K_v \text{ is used} \end{cases}$$

Energy Balance

The valve is modeled as an adiabatic component. No heat exchange can occur between the fluid and the wall that surrounds it. No work is done on or by the fluid as it traverses from inlet to outlet. With these assumptions, energy can flow by advection only, through ports **A** and **B**. By the principle of conservation of energy, the sum of the port energy flows must then always equal zero:

$$\phi_A + \phi_B = 0,$$

where ϕ is defined as the energy flow rate *into* the valve through one of the ports (**A** or **B**).

Ports

Input

L – Valve control signal, unitless

physical signal

Port through which to specify the signal that controls the opening of the valve (in certain valve types associated with *stroke* or *lift percent*). The valve is fully closed at a value of 0 and fully open at a value of 1.

Conserving

A – Flow passage

thermal liquid

Opening through which the flow can enter or exit the flow resistance. Which of the ports serves as inlet and which as outlet depends on the direction of flow.

B – Flow passage

thermal liquid

Opening through which the flow can enter or exit the flow resistance. Which of the ports serves as inlet and which as outlet depends on the direction of flow.

Parameters**Flow coefficient specification – Parameterization by which to specify the flow coefficient of the valve**`Cv coefficient (USG/min) (default) | Kv coefficient (m3/h)`

Choice of flow coefficient to specify. C_v and K_v differ in the physical conditions of their measurement and in the physical units of their expression. Generally at least one of these is reported in product data sheets provided by the manufacturer. Select the option for which data is available.

 C_v coefficient at maximum flow – Flow coefficient expressed in imperial units for a maximally open valve`1 (default) | positive scalar in units of USG/min`

Flow coefficient expressed in imperial units for a valve opened to full capacity. This is the value reported in the valve data sheets when the C_v coefficient is provided by the manufacturer.

 K_v coefficient at maximum flow – Flow coefficient expressed in SI units for a maximally open valve`1 (default) | positive scalar in units of m3/h`

Flow coefficient expressed in SI units for a valve opened to full capacity. This is the value reported in the valve data sheets when the K_v coefficient is provided by the manufacturer.

 C_v coefficient at minimum flow – Flow coefficient expressed in imperial units for a maximally closed valve`1e-4 (default) | positive scalar in units of USG/min`

Flow coefficient expressed in imperial units for a valve that is closed tight and devoid of all flow except for that due to internal leakage between port **A** and port **B**. The primary purpose of this parameter is to ensure the numerical robustness of the model during simulation. Its exact value is less important than its being a very small number greater than zero.

 K_v coefficient at minimum flow – Flow coefficient expressed in SI units for a maximally closed valve`1e-4 (default) | positive scalar in units of m3/h`

Flow coefficient expressed in SI units for a valve that is closed tight and devoid of all flow except for that due to internal leakage between port **A** and port **B**. The primary purpose of this parameter is to ensure the numerical robustness of the model during simulation. Its exact value is less important than it being a very small number greater than zero.

Valve opening characteristics – Parameterization by which to compute the valve opening fraction`Linear (default) | Quick openingEqual percentages`

Choice of valve opening profile to use during simulation. The selection made here determines how the control signal specified at port **L** is converted into a valve opening fraction (and opening area). See the block description for detail on the opening parameterizations.

Exponent number – Denominator of the exponent in the quick-opening parameterization

2 (default) | positive unitless scalar

Number by which to divide the exponent in the governing equation of the quick-opening parameterization. Use a value greater than 1 for a true quick-opening profile, one corresponding to a valve that opens quickly from a maximally closed position but progressively more slowly as it approaches the maximally opened position.

Valve rangeability – Base of the exponent in the equal-percentages parameterization

50 (default) | positive unitless scalar

Number to which the exponent is applied in the governing equation of the equal-percentages parameterization. This number is the ratio between the maximum and minimum flow rates through the valve (the first corresponding obtained when the valve is maximally opened and the second when the valve is maximally closed). Typical values range from 20 to 50.

Cross-sectional area at ports A and B – Flow area at the inlet and outlet of the valve

0.01 m (default) | positive scalar in units of area

Area normal to the flow path at each port. The ports are assumed to be equal in size. The flow area specified here should match those of the inlets of those components to which the valve connects.

Characteristic longitudinal length – Measure of the length of the flow path through the valve

0.1 (default) | positive scalar in units of length

Average distance traversed by the fluid as it travels from inlet to outlet. This distance is used in the calculation of the internal thermal conduction that occurs between the two ports (as part of the smoothed upwind energy scheme employed in the thermal liquid domain).

Critical Reynolds number – Reynolds number at which the flow switches between laminar and turbulent

12 (default) | positive unitless scalar

Reynolds number at which the fluid in the valve is expected to switch between its laminar and turbulent flow regimes. The switch is assumed to occur at once: the transition region that normally exists between the two flow regimes is ignored.

Variables Tab

Mass flow rate into port A – Desired initial value of the mass flow rate at port A

cleared (default) | checked

Mass flow rate to apply at port **A** at the start of simulation. The block uses this value as a guide when preparing the model for simulation. If the value is compatible with the constraints of the model, then it is used to configure the initial state of the valve. If the value conflicts with initial state variables specified in other blocks, then its **Priority** setting determines whether it is applied precisely, approximately, or not at all.

References

[1] *Control Valve Handbook*. 4th ed. Marshalltown, IA: Fisher Controls International. 2005.

[2] *Flow of Fluids through Valves, Fittings and Pipe*. Stamford, CT: Crane, 2010.

Extended Capabilities

C/C++ Code Generation

Generate C and C++ code using Simulink® Coder™.

See Also

Check Valve (TL) | Ball Valve (TL) | Gate Valve (TL)

Introduced in R2016a

Flow Divider

Hydraulic two-path flow divider



Library

Flow Control Valves

Description

The Flow Divider block simulates a hydraulic two-path flow divider, which consists of a spring-centered spool installed in a case, as shown in the figure.

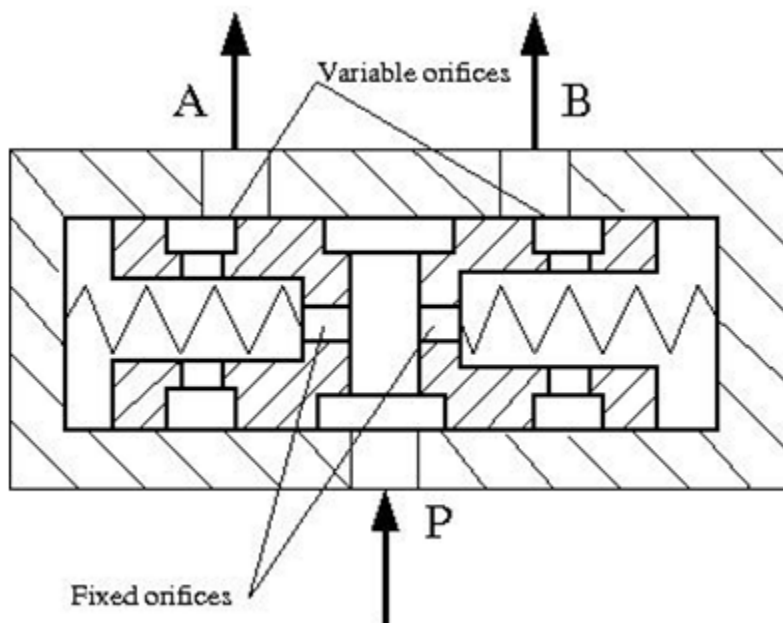

The flow from the source enters the valve through port P and is split into two parts flowing through the P-A and P-B paths. Each path contains a fixed orifice and a variable orifice. The fixed orifices must be precisely matched to divide flow in equal parts, or arranged in a certain proportion if unequal division is required.

The purpose of variable orifices is to maintain a constant pressure drop across the fixed orifices, regardless of pressure fluctuations at valve outlets. The load increase on any outlet causes the pressure drop across the spool (and across fixed orifices) to change, and thus shift the spool. As a result, the passage areas of variable orifices change until the pressure drop values across the fixed orifices even out.

The model of the flow divider uses the Double-Acting Servo Cylinder, Fixed Orifice, and Orifice with Variable Area Round Holes blocks. The following figure shows the schematic diagram of the model. The Double-Acting Servo Cylinder detects the pressure drop and shifts the variable orifice control member accordingly.

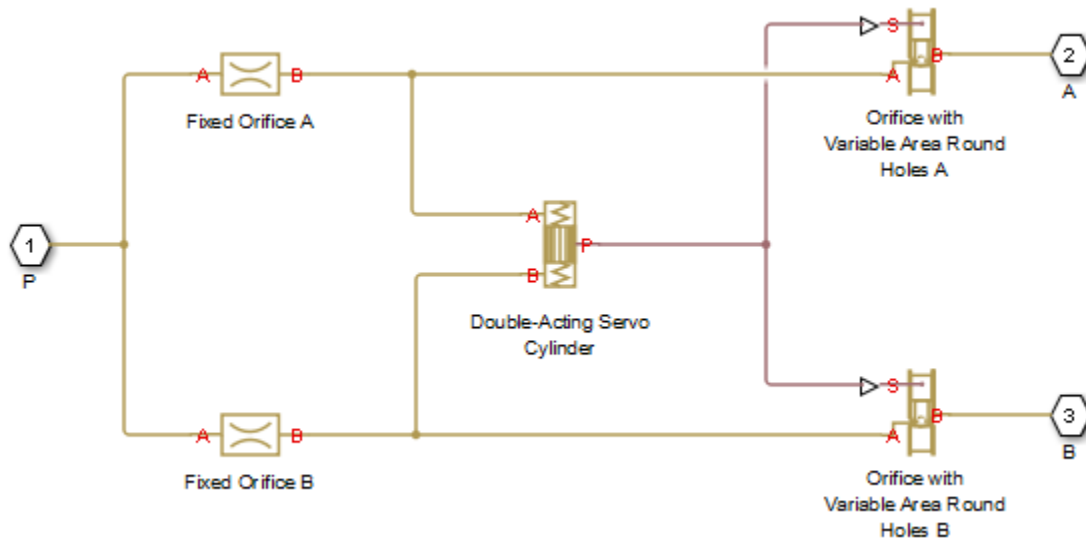

Note You cannot use this block as a flow combiner. Use the Flow Divider-Combiner block instead.

Assumptions and Limitations

- Friction between moving parts is not taken into account.
- Inertia effects are not taken into account.
- Fluid compressibility is not taken into account.
- Leakage flows are assumed to be negligible.
- The hard stops in the Double-Acting Servo Cylinder are assumed to be fully inelastic.

Parameters

- “Fixed Orifices Tab” on page 1-766
- “Variable Orifices Tab” on page 1-767
- “Servo Cylinder Tab” on page 1-768

Fixed Orifices Tab

Fixed orifice A area

The cross-sectional passage area of the fixed orifice in the P-A path. The default value is $1e-4 \text{ m}^2$.

Fixed orifice B area

The cross-sectional passage area of the fixed orifice in the P-B path. The default value is $1e-4 \text{ m}^2$.

Fixed orifice A flow discharge coefficient

Semi-empirical parameter defining the capacity of the fixed orifice in the P-A path. The value depends on the geometrical properties of the orifice, and usually is provided in textbooks or manufacturer data sheets. The default value is 0.7.

Fixed orifice B flow discharge coefficient

Semi-empirical parameter defining the capacity of the fixed orifice in the P-B path. The value depends on the geometrical properties of the orifice, and usually is provided in textbooks or manufacturer data sheets. The default value is 0.7.

Fixed orifice laminar transition specification

Select how the block transitions between the laminar and turbulent regimes:

- **Pressure ratio** — The transition from laminar to turbulent regime is smooth and depends on the value of the **Laminar flow pressure ratio** parameter. This method provides better simulation robustness.
- **Reynolds number** — The transition from laminar to turbulent regime is assumed to take place when the Reynolds number reaches the value specified by the **Critical Reynolds number** parameter.

Fixed orifice A laminar flow pressure ratio

Pressure ratio at which the flow transitions between laminar and turbulent regimes for the fixed orifice in the P-A path. The default value is 0.999. This parameter is visible only if the **Fixed orifice laminar transition specification** parameter is set to **Pressure ratio**.

Fixed orifice B laminar flow pressure ratio

Pressure ratio at which the flow transitions between laminar and turbulent regimes for the fixed orifice in the P-B path. The default value is 0.999. This parameter is visible only if the **Fixed orifice laminar transition specification** parameter is set to **Pressure ratio**.

Fixed orifice A critical Reynolds number

The maximum Reynolds number for laminar flow for the fixed orifice in the P-A path. The transition from laminar to turbulent regime is assumed to take place when the Reynolds number reaches this value. The default value is 10. This parameter is visible only if the **Fixed orifice laminar transition specification** parameter is set to **Reynolds number**.

Fixed orifice B critical Reynolds number

The maximum Reynolds number for laminar flow for the fixed orifice in the P-B path. The transition from laminar to turbulent regime is assumed to take place when the Reynolds number reaches this value. The default value is 10. This parameter is visible only if the **Fixed orifice laminar transition specification** parameter is set to **Reynolds number**.

Variable Orifices Tab**Diameter of round holes**

Diameter of the round holes in the two identical Variable Orifice with Round Holes blocks. The default value is 0.005 m.

Number of round holes

Number of holes in each of the Variable Orifice with Round Holes blocks. The default value is 4.

Variable orifices flow discharge coefficient

Semi-empirical parameter defining the orifice capacity of the Variable Orifice with Round Holes blocks. The value depends on the geometrical properties of the orifice, and usually is provided in textbooks or manufacturer data sheets. The default value is 0.65.

Variable orifice A initial opening

Initial opening of the variable orifice in the P-A path. The parameter can be positive (underlapped orifice), negative (overlapped orifice), or 0 for zero-lap configuration. The value of initial opening does not depend on the orifice orientation. The default value is 0.0025 m.

Variable orifice B initial opening

Initial opening of the variable orifice in the P-B path. The parameter can be positive (underlapped orifice), negative (overlapped orifice), or 0 for zero-lap configuration. The value of initial opening does not depend on the orifice orientation. The default value is 0.0025 m.

Variable orifice laminar transition specification

Select how the block transitions between the laminar and turbulent regimes:

- **Pressure ratio** — The transition from laminar to turbulent regime is smooth and depends on the value of the **Laminar flow pressure ratio** parameter. This method provides better simulation robustness.
- **Reynolds number** — The transition from laminar to turbulent regime is assumed to take place when the Reynolds number reaches the value specified by the **Critical Reynolds number** parameter.

Variable orifice A laminar flow pressure ratio

Pressure ratio at which the flow transitions between laminar and turbulent regimes for the fixed orifice in the P-A path. The default value is 0.999. This parameter is visible only if the **Variable orifice laminar transition specification** parameter is set to **Pressure ratio**.

Variable orifice B laminar flow pressure ratio

Pressure ratio at which the flow transitions between laminar and turbulent regimes for the fixed orifice in the P-B path. The default value is 0.999. This parameter is visible only if the **Variable orifice laminar transition specification** parameter is set to **Pressure ratio**.

Variable orifice A critical Reynolds number

The maximum Reynolds number for laminar flow through the variable orifice in the P-A path. The transition from laminar to turbulent regime is assumed to take place when the Reynolds number reaches this value. The default value is 10. This parameter is visible only if the **Variable orifice laminar transition specification** parameter is set to **Reynolds number**.

Variable orifice B critical Reynolds number

The maximum Reynolds number for laminar flow through the variable orifice in the P-B path. The transition from laminar to turbulent regime is assumed to take place when the Reynolds number reaches this value. The default value is 10. This parameter is visible only if the **Variable orifice laminar transition specification** parameter is set to **Reynolds number**.

Variable orifice leakage area

The total area of possible leaks in each variable orifice when it is completely closed. The main purpose of the parameter is to maintain numerical integrity of the circuit by preventing a portion of the system from becoming isolated after the orifice is completely closed. The parameter value must be greater than 0. The default value is $1e-9 \text{ m}^2$.

Servo Cylinder Tab**Servo cylinder piston area**

The face area of the piston in the servo cylinder. The default value is $1.6e-4 \text{ m}^2$.

Servo cylinder piston stroke

The full piston stroke in the servo cylinder, from one hard stop to another. The piston is located initially in the middle of the stroke and can travel half a stroke in the positive and negative direction. The default value is 0.005 m.

Servo cylinder spring rate

The spring rate of the centering springs in the servo cylinder. The default value is 1000 N/m.

Servo cylinder damping coefficient

The damping coefficient in the contact between the piston and the case of the servo cylinder. The default value is 150 N/(m/s).

Servo cylinder stop penetration coefficient

The penetration property of the piston hard stop in the servo cylinder. The hard stop is represented as absolutely inelastic, and its property is characterized by the penetration coefficient. The default value of the coefficient is $1e12$ N/m/(m/s).

Global Parameters

Parameters determined by the type of working fluid:

- **Fluid density**
- **Fluid kinematic viscosity**

Use the Hydraulic Fluid block or the Custom Hydraulic Fluid block to specify the fluid properties.

Ports

The block has the following ports:

P

Hydraulic conserving port associated with the inlet port P.

A

Hydraulic conserving port associated with the outlet port A.

B

Hydraulic conserving port associated with the outlet port B.

Extended Capabilities**C/C++ Code Generation**

Generate C and C++ code using Simulink® Coder™.

See Also

Double-Acting Servo Cylinder | Fixed Orifice | Flow Divider-Combiner | Orifice with Variable Area Round Holes

Topics

“Upgrading Simscape Fluids Models Containing Hydraulics (Isothermal) Blocks”

Introduced in R2013a

Flow Divider-Combiner

Hydraulic two-path flow divider-combiner



Library

Flow Control Valves

Description

The Flow Divider-Combiner block models a hydraulic valve that divides incoming flow through port P (direct flow) between two outlets, and also maintains a specified proportion between return flows through ports A and B in the total flow rate through port P. In other words, the valve works in two distinctive modes: flow divider for direct flow and flow combiner for reverse flow.

The figure shows a schematic for the flow divider-combiner valve: a) in the divider mode, and b) in the combiner mode.

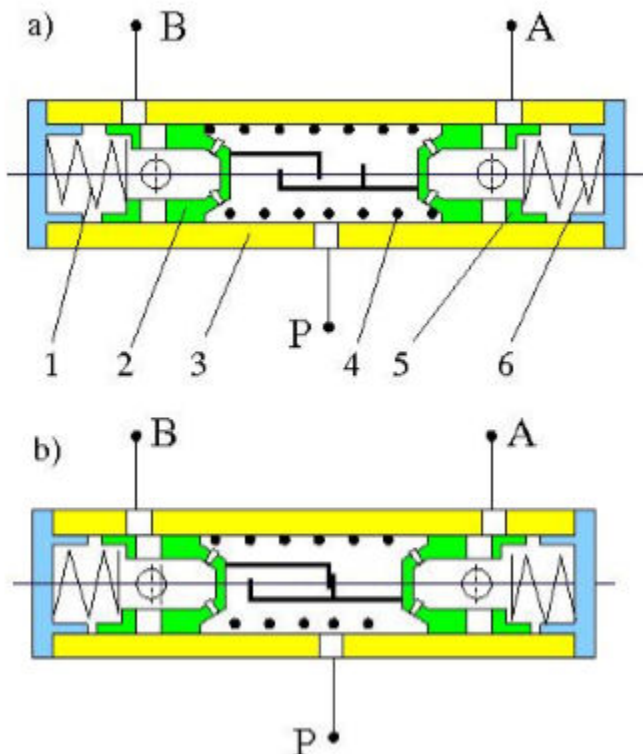

The valve works as a flow divider when fluid is pumped through port P to ports A and B (schematic figure a). In this mode, fluid passes through fixed orifices in pistons 2 and 5 and through variable orifices formed by round holes in the pistons and case. The pressure differential across pistons moves them apart from each other proportionally to the piston areas and the spring 1 and 6 forces. The spring-suspended pistons and the respective variable orifices work as pressure reducing valves maintaining constant pressure drop across fixed orifices and thus keeping flow rates through them practically constant. The flow divider-combiner valve is essentially a combination of two pressure-compensated flow control valves working in parallel.

For reverse flows (schematic figure b), the pressure differential across pistons forces them against each other until the gap in the hard stop is cleared. The pistons settle at a position where pressure drops across fixed orifices are equal, thus maintaining equal flow rates through branches.

The model of the flow divider-combiner uses the Fixed Orifice, Orifice with Variable Area Round Holes, Double-Acting Hydraulic Cylinder (Simple), Translational Hard Stop, Translational Spring, and Translational Damper blocks, as shown in the block diagram.

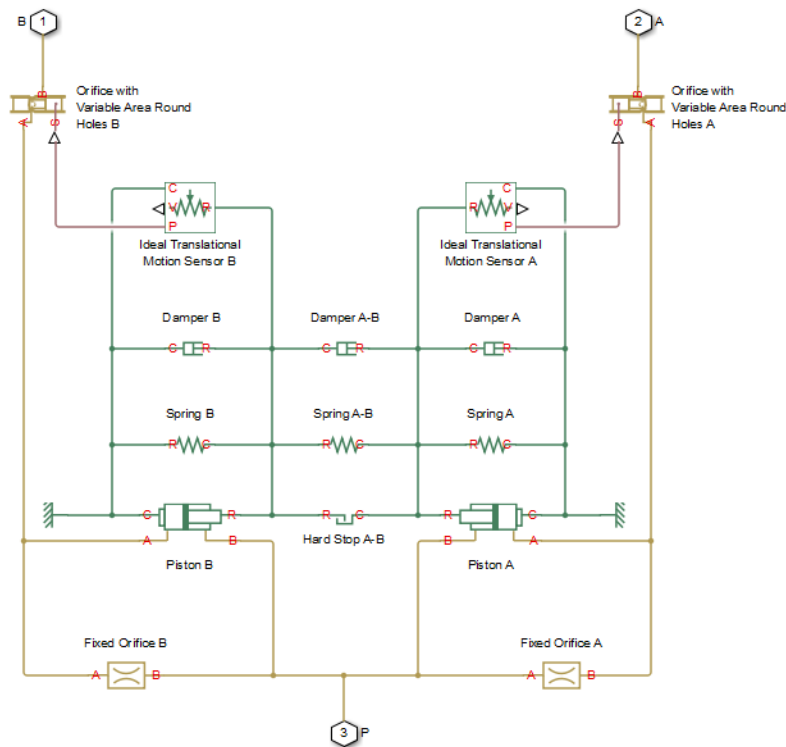

The table explains the purpose of each model component.

Name in the block diagram	Purpose (numbers refer to the valve schematic)	Name in the actual component file
Fixed Orifice A	Fixed orifice in piston 5	fixed_orifice_A
Fixed Orifice B	Fixed orifice in piston 2	fixed_orifice_B
Piston A	Piston 5	piston_A
Piston B	Piston 2	piston_B

Name in the block diagram	Purpose (numbers refer to the valve schematic)	Name in the actual component file
Hard Stop A-B	Hard stop between pistons 2 and 5	hard_stop_A_B
Spring A	Spring 6	spring_A
Spring A-B	Spring 4	spring_A_B
Spring B	Spring 1	spring_B
Damper A	Spring 6 damping	damper_A
Damper A-B	Spring 4 damping	damper_A_B
Damper B	Spring 1 damping	damper_B
Orifice with Variable Area Round Holes A	Variable orifice created by round holes in piston 5 and the case	variable_orifice_A
Orifice with Variable Area Round Holes B	Variable orifice created by round holes in piston 2 and the case	variable_orifice_B
Ideal Translational Motion Sensor A	Measures piston 5 displacement and exports the measurement to the Orifice with Variable Area Round Holes A	sensor_A
Ideal Translational Motion Sensor B	Measures piston 2 displacement and exports the measurement to the Orifice with Variable Area Round Holes B	sensor_B

The block orientations in the model are explained by the structure section of the underlying component file, reproduced below:

```
connections
  connect(P, fixed_orifice_A.A, fixed_orifice_B.A, piston_A.B, piston_B.B);
  connect(fixed_orifice_A.B, piston_A.A, variable_orifice_A.A);
  connect(fixed_orifice_B.B, piston_B.A, variable_orifice_B.A);
  connect(B, variable_orifice_B.B);
  connect(A, variable_orifice_A.B);
  connect(reference.V, piston_A.C, spring_A.C, damper_A.C, sensor_A.C, ...
    piston_B.C, spring_B.C, damper_B.C, sensor_B.C);
  connect(piston_A.R, spring_A.R, hard_stop_A_B.C, spring_A_B.C, ...
    damper_A.R, damper_A_B.R, sensor_A.R);
  connect(piston_B.R, spring_B.R, hard_stop_A_B.R, spring_A_B.R, ...
    damper_B.R, damper_A_B.C, sensor_B.R);
  connect(sensor_A.P, variable_orifice_A.S);
  connect(sensor_B.P, variable_orifice_B.S);
end
```

Assumptions and Limitations

The block does not account for inertia, friction, and hydraulic forces. For additional assumptions and limitations, see the reference pages of the underlying member blocks.

Parameters

- “Fixed Orifices Tab” on page 1-774
- “Pistons Tab” on page 1-774
- “Springs/Dampers Tab” on page 1-775
- “Variable Orifices Tab” on page 1-775
- “Hard Stop Between Pistons Tab” on page 1-777

Fixed Orifices Tab

Fixed orifice A area

The cross-sectional passage area of the fixed orifice in piston 5 (the P-A path). The default value is $1.5e-5 \text{ m}^2$.

Fixed orifice B area

The cross-sectional passage area of the fixed orifice in piston 2 (the P-B path). The default value is $1.5e-5 \text{ m}^2$.

Fixed orifice flow discharge coefficient

Semi-empirical coefficient for fixed orifice capacity characterization. The value depends on the orifice geometrical properties, and usually is provided in textbooks or manufacturer data sheets. The default value is 0.7.

Fixed orifice laminar transition specification

Select how the block transitions between the laminar and turbulent regimes for the fixed orifices:

- **Pressure ratio** — The transition from laminar to turbulent regime is smooth and depends on the value of the **Fixed orifice laminar flow pressure ratio** parameter. This method provides better simulation robustness.
- **Reynolds number** — The transition from laminar to turbulent regime is assumed to take place when the Reynolds number reaches the value specified by the **Fixed orifice critical Reynolds number** parameter.

Fixed orifice laminar flow pressure ratio

Pressure ratio at which the flow transitions between laminar and turbulent regimes. The default value is 0.999. This parameter is visible only if the **Fixed orifice laminar transition specification** parameter is set to **Pressure ratio**.

Fixed orifice critical Reynolds number

The maximum Reynolds number for laminar flow in the fixed orifices. The transition from laminar to turbulent regime is assumed to take place when the Reynolds number reaches this value. The default value is 10. This parameter is visible only if the **Fixed orifice laminar transition specification** parameter is set to **Reynolds number**.

Pistons Tab

Piston A area

The face area of Piston A (piston 5). The default value is $2e-4 \text{ m}^2$.

Piston A stroke

The full stroke of Piston A. The default value is 5 mm.

Piston A initial extension

The initial extension of Piston A. The default value is 0 m.

Piston B area

The face area of Piston B (piston 2). The default value is $2e-4 \text{ m}^2$.

Piston B stroke

The full stroke of Piston B. The default value is 5 mm.

Piston B initial extension

The initial extension of Piston B. The default value is 0 m.

Piston stop penetration coefficient

The penetration property of colliding bodies in the underlying cylinder blocks, which is assumed to be absolutely plastic. The default value is $1e12 \text{ s}^2/\text{N/m}^2$.

Springs/Dampers Tab**Spring A rate**

Spring rate of Spring A (spring 6). The default value is $1e3 \text{ N/m}$.

Spring A preload

This parameter sets the initial high-priority target value for the **Deformation** variable in the underlying Spring A block. For more information, see "Variable Priority for Model Initialization". The default value is 0.1 m.

Damping coefficient A

Damping coefficient of Damper A (spring 6 damping). The default value is 150 N/(m/s) .

Spring B rate

Spring rate of Spring B (spring 1). The default value is $1e3 \text{ N/m}$.

Spring B preload

This parameter sets the initial high-priority target value for the **Deformation** variable in the underlying Spring B block. For more information, see "Variable Priority for Model Initialization". The default value is -0.1 m.

Damping coefficient B

Damping coefficient of Damper B (spring 1 damping). The default value is 150 N/(m/s) .

Spring A-B rate

Spring rate of Spring A-B (spring 4). The default value is $1e3 \text{ N/m}$.

Spring A-B preload

This parameter sets the initial high-priority target value for the **Deformation** variable in the underlying Spring A-B block. For more information, see "Variable Priority for Model Initialization". The default value is 0.1 m.

Damping coefficient A_B

Damping coefficient of Damper A-B (spring 4 damping). The default value is 150 N/(m/s) .

Variable Orifices Tab**Variable orifice A hole diameter**

Diameter of the holes in the underlying Orifice with Variable Area Round Holes A block. The default value is 0.0025 m.

Variable orifice B hole diameter

Diameter of the holes in the underlying Orifice with Variable Area Round Holes B block. The default value is 0.0025 m.

Number of hole pairs in the variable orifice

Number of holes in each of the Orifice with Variable Area Round Holes blocks. The default value is 4.

Variable orifice flow discharge coefficient

Semi-empirical parameter defining the orifice capacity of the Orifice with Variable Area Round Holes blocks. The value depends on the geometrical properties of the orifice, and usually is provided in textbooks or manufacturer data sheets. The default value is 0.7.

Variable orifice A initial center distance

Initial opening in the underlying Orifice with Variable Area Round Holes A block. The parameter value can be positive (underlapped orifice), negative (overlapped orifice), or equal to zero for zero lap configuration. The default value is 0.0025 m, which corresponds to the position of piston 5 in the valve schematic drawing.

Variable orifice B initial center distance

Initial opening in the underlying Orifice with Variable Area Round Holes B block. The parameter value can be positive (underlapped orifice), negative (overlapped orifice), or equal to zero for zero lap configuration. The default value is -0.0025 m, which corresponds to the position of piston 2 in the valve schematic drawing.

Variable orifice laminar transition specification

Select how the block transitions between the laminar and turbulent regimes for the variable orifices:

- **Pressure ratio** — The transition from laminar to turbulent regime is smooth and depends on the value of the **Variable orifice laminar flow pressure ratio** parameter. This method provides better simulation robustness.
- **Reynolds number** — The transition from laminar to turbulent regime is assumed to take place when the Reynolds number reaches the value specified by the **Variable orifice critical Reynolds number** parameter.

Variable orifice laminar flow pressure ratio

Pressure ratio at which the flow transitions between laminar and turbulent regimes. The default value is 0.999. This parameter is visible only if the **Variable orifice laminar transition specification** parameter is set to **Pressure ratio**.

Variable orifice critical Reynolds number

The maximum Reynolds number for laminar flow through the variable orifices. The transition from laminar to turbulent regime is assumed to take place when the Reynolds number reaches this value. The default value is 10. This parameter is visible only if the **Variable orifice laminar transition specification** parameter is set to **Reynolds number**.

Variable orifice leakage area

The total area of possible leaks in each variable orifice when it is completely closed. The main purpose of the parameter is to maintain numerical integrity of the circuit by preventing a portion of the system from becoming isolated after the orifice is completely closed. The parameter value must be greater than 0. The default value is $1e-9 \text{ m}^2$.

Hard Stop Between Pistons Tab

Hard stop upper bound

Gap between the slider and the upper bound in the underlying Hard Stop block. The default value is 5.1 mm.

Hard stop lower bound

Gap between the slider and the lower bound in the underlying Hard Stop block. The default value is 1 mm.

Hard stop stiffness

The elastic property of colliding bodies in the hard stop. The default value is 1e8 N/m.

Hard stop damping coefficient

The dissipating property of colliding bodies in the hard stop. The default value is 150 N/(m/s).

Global Parameters

Parameters determined by the type of working fluid:

- **Fluid density**
- **Fluid kinematic viscosity**

Use the Hydraulic Fluid block or the Custom Hydraulic Fluid block to specify the fluid properties.

Ports

The block has the following ports:

P

Hydraulic conserving port associated with the inlet port P.

A

Hydraulic conserving port associated with the outlet port A.

B

Hydraulic conserving port associated with the outlet port B.

Extended Capabilities

C/C++ Code Generation

Generate C and C++ code using Simulink® Coder™.

See Also

Double-Acting Hydraulic Cylinder (Simple) | Fixed Orifice | Flow Divider | Orifice with Variable Area Round Holes | Translational Damper | Translational Hard Stop | Translational Spring

Topics

“Upgrading Simscape Fluids Models Containing Hydraulics (Isothermal) Blocks”

Introduced in R2014b

Gas-Charged Accumulator (IL)

Accumulator with gas as compressible medium in an isothermal liquid system

Library: Simscape / Fluids / Isothermal Liquid / Tanks & Accumulators



Description

The Gas-Charged Accumulator (IL) block models a gas-charged accumulator in an isothermal liquid network. The accumulator consists of a precharged gas chamber and a liquid chamber. The chambers are separated by a bladder, a piston, or any kind of a diaphragm.

As the liquid pressure at the accumulator inlet becomes greater than the precharge pressure, liquid enters the accumulator and compresses the gas through a polytropic process. A decrease in the liquid pressure causes the gas to decompress and discharge stored liquid into the system. The separator motion is restricted by a hard stop when the liquid volume is zero and when the liquid volume is at the liquid chamber capacity. The liquid chamber capacity is the total accumulator volume minus the minimum gas volume.

Inlet liquid resistance, and separator properties such as inertia and damping are not modeled. The flow rate is positive if liquid flows into the accumulator.

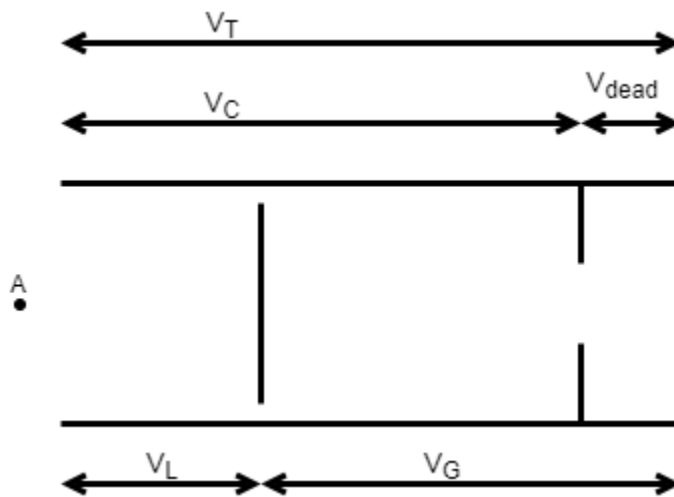

This diagram represents a gas-charged accumulator. The total accumulator volume, V_T , is divided into the liquid chamber on the left and the gas chamber on the right by the vertical separator. The distance between the left side and the separator defines the liquid volume, V_L . The distance between the right side and the separator defines the gas volume, V_G . The liquid chamber capacity, V_C , is less than the total accumulator volume, so that the gas volume never becomes zero:

$$V_L = V_T - V_G$$

$$V_C = V_T - V_{dead}$$

where:

- V_T is the total volume of the accumulator, including the liquid chamber and the gas chamber.
- V_L is the volume of the liquid in the accumulator.
- V_G is the volume of the gas in the accumulator.
- V_C is the liquid chamber capacity ($V_T - V_G$).
- V_{dead} is the gas chamber dead volume, a small portion of the gas chamber that remains filled with gas when the liquid chamber is at capacity.

The hard stop contact pressure is modeled with a stiffness term and a damping term. The relationship of the gas pressure and gas volume between the current state and the precharge state is polytropic and pressure is balanced at the separator:

$$p_G V_G^{k_{sh}} = p_{pr} V_T^{k_{sh}},$$

where:

- p_G is the gas pressure in the gas chamber.
- p_{pr} is the pressure in the gas chamber when the liquid chamber is empty
- k_{sh} is the specific heat ratio (adiabatic index).

Conservation of Mass

Conservation of mass is represented by the following equation.

$$\left\{ \begin{array}{ll} \dot{p}_I \frac{d\rho_I}{dp_I} V_L + \rho_I \dot{V}_L = \dot{m}_A, & \text{compressibility on} \\ \rho_I \dot{V}_L = \dot{m}_A, & \text{compressibility of f} \end{array} \right.$$

where:

- p_I is the liquid pressure in the liquid chamber, which is equal to the pressure at the accumulator inlet.
- \dot{m}_A is the mass flow rate of liquid coming into port **A**.
- ρ_I is the density of the liquid in the liquid chamber.

$$\dot{V}_L = \begin{cases} \frac{\dot{p}_I}{k_{sh} \frac{p_G}{V_G}}, & \text{if } 0 < V_L < V_C \\ \frac{\dot{p}_I}{k_{sh} \frac{p_G}{V_G} + K_{stiff}}, & \text{else} \end{cases}$$

where K_{stiff} is the hard-stop stiffness coefficient.

Conservation of Momentum

Conservation of momentum is represented by:

$$p_I = p_G + p_{HS}$$

where p_{HS} is the hard-stop contact pressure.

$$p_{HS} = \begin{cases} (V_L - V_C)K_{stiff}, & \text{if } V_L \geq V_C \\ V_L K_{stiff}, & \text{if } V_L \leq 0 \\ 0, & \text{else} \end{cases}$$

Variables

Use the **Variables** tab to set the priority and initial target values for the block variables prior to simulation. For more information, see “Set Priority and Initial Target for Block Variables”.

Ports

Conserving

A – Liquid port

isothermal liquid

Isothermal liquid port associated with the accumulator inlet. The flow rate is positive if liquid flows into the accumulator.

Parameters

Total accumulator volume – Accumulator volume

8e-3 m³ (default) | positive scalar

Total volume of the accumulator, including the liquid chamber and the gas chamber. It is the sum of the liquid chamber capacity and the minimum gas volume.

Minimum gas volume – Gas chamber dead volume

4e-5 m³ (default) | positive scalar

Gas chamber dead volume, which is defined as a small portion of the gas chamber that remains filled with gas when the liquid chamber is filled to capacity. A nonzero volume is necessary so that the gas pressure does not become infinite when the liquid chamber is at capacity.

Precharge pressure – Gas chamber pressure

1.101325 MPa (default) | positive scalar

Pressure in the gas chamber when the liquid chamber is empty.

Specific heat ratio – Specific heat ratio

1.4 (default) | positive scalar

Specific heat ratio (adiabatic index). To account for heat exchange, set it to a value normally between 1 and 2, depending on the properties of the gas in the gas chamber. For dry air at 20°C, this value is 1 for an isothermal process or 1.4 for an adiabatic (and isentropic) process.

Hard stop stiffness coefficient – Proportionality constant

1e4 MPa/m³ (default) | positive scalar

Proportionality constant of the hard-stop contact pressure with respect to the liquid volume penetrated into the hard stop. The hard stops are used to restrict the liquid volume between zero and liquid chamber capacity.

Fluid dynamic compressibility – Fluid compressibility

On (default) | Off

Whether to model any change in fluid density due to fluid compressibility. When **Fluid compressibility** is set to On, changes due to the mass flow rate into the block are calculated in addition to density changes due to changes in pressure. In the Isothermal Liquid Library, all blocks calculate density as a function of pressure.

See Also

Gas-Charged Accumulator (TL) | Spring-Loaded Accumulator (IL)

Introduced in R2020a

Gas-Charged Accumulator

Hydraulic accumulator with gas as compressible medium



Library

Accumulators

Description

This block models a gas-charged accumulator. The accumulator consists of a precharged gas chamber and a fluid chamber. The fluid chamber is connected to a hydraulic system. The chambers are separated by a bladder, a piston, or any kind of a diaphragm.

As the fluid pressure at the accumulator inlet becomes greater than the precharge pressure, fluid enters the accumulator and compresses the gas, storing hydraulic energy. A decrease in the fluid pressure causes the gas to decompress and discharge the stored fluid into the system.

During typical operations, the pressure in the gas chamber is equal to the pressure in the fluid chamber. However, if the pressure at the accumulator inlet drops below the precharge pressure, the gas chamber becomes isolated from the system. In this situation, the fluid chamber is empty and the pressure in the gas chamber remains constant and equal to the precharge pressure. The pressure at the accumulator inlet depends on the hydraulic system to which the accumulator is connected. If the pressure at the accumulator inlet builds up to the precharge pressure or higher, fluid enters the accumulator again.

The motion of the separator between the fluid chamber and the gas chamber is restricted by two hard stops that limit the expansion and contraction of the fluid volume. The fluid volume is limited when the fluid chamber is at capacity and when the fluid chamber is empty. The hard stops are modeled with finite stiffness and damping. This means that it is possible for the fluid volume to become negative or greater than the fluid chamber capacity, depending on the values of the hard-stop stiffness coefficient and the accumulator inlet pressure.

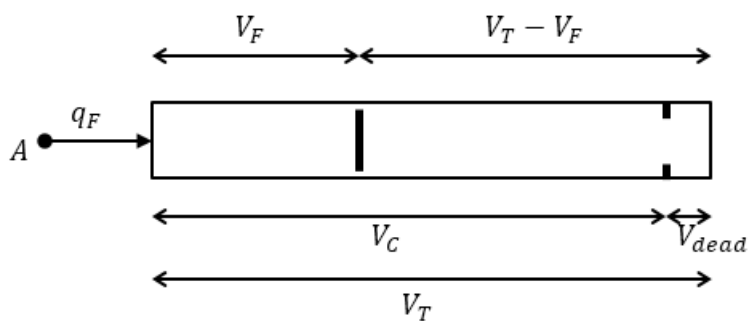

The diagram represents a gas-charged accumulator. The total accumulator volume (V_T) is divided into the fluid chamber on the left and the gas chamber on the right by the vertical separator. The distance between the left side and the separator defines the fluid volume (V_F). The distance between the right side and the separator defines the gas volume ($V_T - V_F$). The fluid chamber capacity (V_C) is less than the total accumulator volume (V_T) so that the gas volume never becomes zero.

The hard stop contact pressure is modeled with a stiffness term and a damping term. The relationship of the gas pressure and gas volume between the current state and the precharge state is given by the polytropic relation, with pressure balanced at the separator:

$$(p_G + p_A)(V_T - V_F)^k = (p_{pr} + p_A)V_T^k$$

$$p_F = p_G + p_{HS}$$

$$V_C = V_T - V_{dead}$$

$$p_{HS} = \begin{cases} K_S(V_F - V_C) + K_d q_F^{\pm}(V_F - V_C) & \text{if } V_F \geq V_C \\ K_S V_F - K_d q_F^- V_F & \text{if } V_F \leq 0 \\ 0 & \text{otherwise} \end{cases}$$

$$q_F^{\pm} = \begin{cases} q_F & \text{if } q_F \geq 0 \\ 0 & \text{otherwise} \end{cases}$$

$$q_F^- = \begin{cases} q_F & \text{if } q_F \leq 0 \\ 0 & \text{otherwise} \end{cases}$$

where

V_T	Total volume of the accumulator, including the fluid chamber and the gas chamber
V_F	Volume of fluid in the accumulator
V_{init}	Initial volume of fluid in the accumulator
V_C	Fluid chamber capacity, the difference between total accumulator volume and the gas chamber dead volume
V_{dead}	Gas chamber dead volume, a small portion of the gas chamber that remains filled with gas when the fluid chamber is at capacity
p_F	Fluid pressure (gauge) in the fluid chamber, which is equal to the pressure at the accumulator inlet
p_{pr}	Pressure (gauge) in the gas chamber when the fluid chamber is empty
p_A	Atmospheric pressure
p_G	Gas pressure (gauge) in the gas chamber
p_{HS}	Hard-stop contact pressure
K_S	Hard-stop stiffness coefficient
K_d	Hard-stop damping coefficient
k	Specific heat ratio (adiabatic index)
q_F	Fluid flow rate into the accumulator, which is positive if fluid flows into the accumulator

The flow rate into the accumulator is the rate of change of the fluid volume:

$$q_F = \frac{dV_F}{dt}$$

At $t = 0$, the initial condition is $V_F = V_{\text{init}}$, where V_{init} is the value you assign to the **Initial fluid volume** parameter.

Basic Assumptions and Limitations

- The process in the gas chamber is assumed to be polytropic.
- Loading on the separator, such as inertia or friction, is not considered.
- Inlet hydraulic resistance is not considered.
- Fluid compressibility is not considered.

Parameters

- “Parameters Tab” on page 1-784
- “Variables Tab” on page 1-785

Parameters Tab

Total accumulator volume

Total volume of the accumulator including the fluid chamber and the gas chamber. It is the sum of the fluid chamber capacity and the minimum gas volume. The default value is $8e-3 \text{ m}^3$.

Minimum gas volume

Gas chamber dead volume, a small portion of the gas chamber that remains filled with gas when the fluid chamber is at capacity. A nonzero volume is necessary so that the gas pressure does not become infinite when the fluid chamber is at capacity. The default value is $4e-5 \text{ m}^3$.

Precharge pressure (gauge)

Pressure (gauge) in the gas chamber when the fluid chamber is empty. The default value is $10e5 \text{ Pa}$.

Specific heat ratio

Specific heat ratio (adiabatic index). To account for heat exchange, you can set it to a value normally between 1 and 2, depending on the properties of the gas in the gas chamber. For dry air at 20°C , this value is 1 for an isothermal process and 1.4 for an adiabatic (and isentropic) process. The default value is 1.4.

Hard-stop stiffness coefficient

Proportionality constant of the hard-stop contact pressure with respect to the fluid volume penetrated into the hard stop. The hard stops are used to restrict the fluid volume between zero and fluid chamber capacity. The default value is $1e10 \text{ Pa/m}^3$.

Hard-stop damping coefficient

Proportionality constant of the hard-stop contact pressure with respect to the flow rate and the fluid volume penetrated into the hard stop. The hard stops are used to restrict the fluid volume between zero and fluid chamber capacity. The default value is $1e10 \text{ Pa*s/m}^6$.

Variables Tab

Accumulator flow rate

Volumetric flow rate through the accumulator port at time zero. Simscape software uses this parameter to guide the initial configuration of the component and model. Initial variables that conflict with each other or are incompatible with the model may be ignored. Set the **Priority** column to High to prioritize this variable over other, low-priority, variables.

Volume of fluid

Volume of fluid in the accumulator at time zero. Simscape software uses this parameter to guide the initial configuration of the component and model. Initial variables that conflict with each other or are incompatible with the model may be ignored. Set the **Priority** column to High to prioritize this variable over other, low-priority, variables.

Pressure of liquid volume

Gauge pressure in the accumulator at time zero. Simscape software uses this parameter to guide the initial configuration of the component and model. Initial variables that conflict with each other or are incompatible with the model may be ignored. Set the **Priority** column to High to prioritize this variable over other, low-priority, variables.

Global Parameters

Atmospheric pressure

Absolute pressure of the environment. The default value is 101325 Pa.

Ports

The block has one hydraulic conserving port associated with the accumulator inlet.

The flow rate is positive if fluid flows into the accumulator.

Extended Capabilities

C/C++ Code Generation

Generate C and C++ code using Simulink® Coder™.

See Also

Spring-Loaded Accumulator

Topics

“Upgrading Simscape Fluids Models Containing Hydraulics (Isothermal) Blocks”

Introduced in R2006a

Gas-Charged Accumulator (TL)

Pressurized thermal liquid container with compressed gas charge



Library

Thermal Liquid/Tanks & Accumulators

Description

The Gas-Charged Accumulator (TL) block models a pressurized thermal liquid container with a compressed gas charge. The accumulator consists of thermal liquid and gas chambers separated by a hermetic and insulated diaphragm.

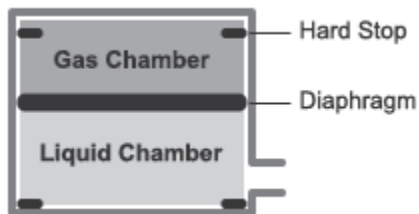

Accumulator Schematic

If the inlet pressure is greater than the gas charge pressure, the liquid chamber volume increases, compressing the gas chamber. If the inlet pressure is lower than the gas charge pressure, the liquid chamber volume decreases, decompressing the gas chamber.

Hard stops limit the diaphragm motion when the liquid chamber is at capacity and when the liquid chamber is empty. The hard-stop compliance is modeled through spring and damper forces. If the specified spring stiffness is low, the liquid volume can momentarily fall below zero or rise above capacity.

Chamber Volumes

The liquid chamber volume is the difference between the total accumulator volume and the gas chamber volume:

$$V_L = V_T - V_G,$$

where:

- V_L is the liquid chamber volume.
- V_T is the total accumulator volume.
- V_G is the gas chamber volume.



Chamber Volumes

The liquid chamber capacity is the difference between the total accumulator volume and the dead volume of gas in the accumulator at full capacity:

$$V_C = V_T - V_{Dead},$$

where:

- V_C is the liquid chamber capacity.
- V_{Dead} is the dead volume of gas at full capacity.

The gas chamber pressure and volume follow from the precharge states as described by the polytropic equation

$$p_G V_G^k = p_{pr} V_T^k,$$

where:

- p_G is the gas chamber pressure at a given time step.
- V_G is the gas chamber volume at a given time step.
- p_{pr} is the precharge gas chamber pressure when the liquid chamber is empty.
- V_T is the total liquid chamber volume.
- k is the polytropic index.

Mass Balance

The mass conservation equation in the liquid chamber is

$$V_L \rho_L \left(\frac{1}{\beta_L} \frac{dp_L}{dt} - \alpha_L \frac{dT_L}{dt} \right) + \rho_L \frac{dV_L}{dt} = \dot{m}_A,$$

where:

- ρ_L is the thermal liquid density.
- β_L is the isothermal bulk modulus.
- α_L is the isobaric thermal expansion coefficient.
- p_L is the thermal liquid pressure.
- T_L is the thermal liquid temperature.
- \dot{m}_A is the thermal liquid mass flow rate into the accumulator through port A.

The time variation of the liquid chamber volume is given by the conditional equation

$$\frac{dV_L}{dt} = \begin{cases} \frac{\dot{p}_L}{kp_{pr}V_T^kV_G^{(-k-1)} + K_s + K_d\dot{m}^+/\rho_L}, & V_L \geq V_C \\ \frac{\dot{p}_L}{kp_{pr}V_T^kV_G^{(-k-1)} + K_s - K_d\dot{m}^-/\rho_L}, & V_L \leq 0 \\ \frac{\dot{p}_L}{kp_{pr}V_T^kV_G^{(-k-1)}}, & \text{Else} \end{cases}$$

where:

- K_s is the hard-stop stiffness coefficient.
- K_d is the hard-stop damping coefficient.
- \dot{m}^+ is the mass flow rate into the liquid chamber when the accumulator diaphragm contacts the top hard stop:

$$\dot{m}^+ = \begin{cases} \dot{m}, & \dot{m} > 0 \\ 0, & \text{Else} \end{cases}$$

- \dot{m}^- is the mass flow rate from the liquid chamber when the accumulator diaphragm contacts the bottom hard stop:

$$\dot{m}^- = \begin{cases} \dot{m}, & \dot{m} < 0 \\ 0, & \text{Else} \end{cases}$$

Momentum Balance

The momentum conservation equation in the accumulator volume is

$$p_L = p_G + p_{HS},$$

where:

- p_{HS} is the hard-stop contact pressure:

$$p_{HS} = \begin{cases} (V_L - V_C)(K_s + K_d\dot{m}^+/\rho), & V_L \geq V_C \\ V_L(K_s - K_d\dot{m}^-/\rho), & V_L \leq 0 \\ 0, & \text{Else} \end{cases}$$

Energy Balance

The energy conservation equation in the liquid chamber volume is

$$\frac{d}{dt}(\rho_L u_L V_L) = \phi_A + \phi_H,$$

where:

- u_L is the thermal liquid specific internal energy.
- ϕ_A is the energy flow rate into the liquid chamber through the accumulator inlet.
- ϕ_H is the thermal energy flow rate into the liquid chamber through the accumulator wall.

Assumptions and Limitations

- Gas chamber compression is treated as a polytropic process.
- Diaphragm loading is ignored.
- Fluid inertia is ignored.

Parameters

Parameters Tab

Total accumulator volume

Combined liquid and gas volume in the accumulator. The default value is $8e-3 \text{ m}^3$.

Minimum gas volume

Remnant gas volume in the accumulator in a completely filled state. The default value is $4e-5 \text{ m}^3$.

Precharge pressure

Initial gas charge pressure of the empty accumulator. Fluid enters the accumulator if the inlet pressure is equal to or greater than the precharge pressure. The default value is 0 MPa gauge pressure.

Specific heat ratio

Ratio of the gas specific heat at constant pressure to that at constant volume. The default value is 1.4 .

Hard-stop stiffness coefficient

Stiffness coefficient of the top and bottom accumulator hard stops. The hard stops restrict diaphragm motion between zero and the maximum liquid chamber level. The stiffness coefficient accounts for the restorative portion of the hard-stop contact forces. The default value is $1e4 \text{ MPa/m}^3$.

Hard-stop damping coefficient

Damping coefficients of the top and bottom accumulator hard stops. The hard stops restrict diaphragm motion between zero and the maximum liquid chamber level. The damping coefficients account for the dissipative portion of the hard-stop contact forces. The default value is $1e4 \text{ s*MPa/m}^6$.

Cross-sectional area at port A

Flow cross-sectional area at the accumulator inlet. The default value is 0.01 m^2 .

Variables Tab

Volume of liquid

Volume of thermal liquid in the accumulator at the start of simulation. The default value is 0.005 m^3 .

Mass of liquid

Mass of thermal liquid in the accumulator at the start of simulation. The default value is 5 kg .

Pressure of liquid volume

Pressure in the thermal liquid chamber at the start of simulation. The default value is 0.101325 MPa .

Temperature of liquid volume

Temperature in the thermal liquid chamber at the start of simulation. The default value is 293.15 K.

Ports

- A — Thermal liquid port representing the accumulator inlet
- H — Thermal port representing heat transfer between the liquid and the environment through the accumulator wall

Extended Capabilities**C/C++ Code Generation**

Generate C and C++ code using Simulink® Coder™.

See Also

Tank (TL)

Introduced in R2016a

Gate Valve

Hydraulic gate valve



Library

Flow Control Valves

Description

The Gate Valve block models a valve consisting of a round orifice in the valve housing and a flat gate, which moves perpendicular to the orifice axis. The orifice in the gate has the same diameter as the orifice in the housing. As the gate moves, it opens or closes the valve passage (shown as a shaded area in the following illustration).

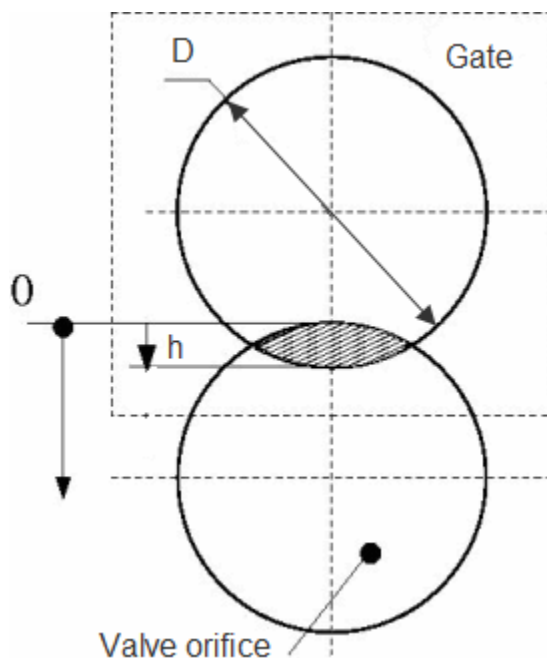

The flow rate through the valve is proportional to the valve opening and to the pressure differential across the valve. The flow rate is determined according to the following equations:

$$q = C_D \cdot A(h) \sqrt{\frac{2}{\rho} \frac{\Delta p}{(\Delta p^2 + p_{Cr}^2)^{1/4}}}$$

$$\Delta p = p_A - p_B,$$

$$h = x_0 + x$$

$$A(h) = \begin{cases} A_{leak} & \text{for } h \leq 0 \text{ or } h > 2D \\ D^2 \cdot \left(\frac{\alpha}{2} - \frac{\sin(2\alpha)}{4} \right), \alpha = a \cos \left| 1 - \frac{h}{D} \right| & \text{for } 0 < h \leq 2D \end{cases}$$

where

q	Flow rate
p	Pressure differential
p_A, p_B	Gauge pressures at the block terminals
C_D	Flow discharge coefficient
$A(h)$	Instantaneous orifice passage area
x_0	Initial opening
x	Gate displacement from initial position
h	Valve opening
D	Orifice diameter
ρ	Fluid density
A_{leak}	Closed valve leakage area
p_{cr}	Minimum pressure for turbulent flow

The minimum pressure for turbulent flow, p_{cr} , is calculated according to the laminar transition specification method:

- By pressure ratio — The transition from laminar to turbulent regime is defined by the following equations:

$$p_{cr} = (p_{avg} + p_{atm})(1 - B_{lam})$$

$$p_{avg} = (p_A + p_B)/2$$

where

p_{avg}	Average pressure between the block terminals
p_{atm}	Atmospheric pressure, 101325 Pa
B_{lam}	Pressure ratio at the transition between laminar and turbulent regimes (Laminar flow pressure ratio parameter value)

- By Reynolds number — The transition from laminar to turbulent regime is defined by the following equations:

$$p_{cr} = \frac{\rho}{2} \left(\frac{Re_{cr} \cdot \nu}{C_D \cdot D_H} \right)^2$$

$$D_H = \sqrt{\frac{4A}{\pi}}$$

where

D_H	Valve instantaneous hydraulic diameter
ν	Fluid kinematic viscosity
Re_{cr}	Critical Reynolds number (Critical Reynolds number parameter value)

Connections A and B are hydraulic conserving ports. Connection S is a physical signal port that controls the gate displacement. The block positive direction is from port A to port B. This means that the flow rate is positive if it flows from A to B, and the pressure differential is determined as $\Delta p = p_A - p_B$. Positive signal at the physical signal port S opens the valve.

Basic Assumptions and Limitations

- No inertial effects are taken into account.

Parameters

Valve orifice diameter

The diameter of the valve orifice. The orifices in the valve housing and in the gate have the same diameter. The default value is 0.01 m.

Initial opening

The initial opening of the valve. The parameter can take both positive and negative values. The default value is 0.

Flow discharge coefficient

Semi-empirical parameter for valve capacity characterization. Its value depends on the geometrical properties of the orifice, and usually is provided in textbooks or manufacturer data sheets. The default value is 0.65.

Laminar transition specification

Select how the block transitions between the laminar and turbulent regimes:

- **Pressure ratio** — The transition from laminar to turbulent regime is smooth and depends on the value of the **Laminar flow pressure ratio** parameter. This method provides better simulation robustness.
- **Reynolds number** — The transition from laminar to turbulent regime is assumed to take place when the Reynolds number reaches the value specified by the **Critical Reynolds number** parameter.

Laminar flow pressure ratio

Pressure ratio at which the flow transitions between laminar and turbulent regimes. The default value is 0.999. This parameter is visible only if the **Laminar transition specification** parameter is set to **Pressure ratio**.

Critical Reynolds number

The maximum Reynolds number for laminar flow. The value of the parameter depends on the orifice geometrical profile. You can find recommendations on the parameter value in hydraulics textbooks. The default value is 10. This parameter is visible only if the **Laminar transition specification** parameter is set to **Reynolds number**.

Leakage area

The total area of possible leaks in the completely closed valve. The main purpose of the parameter is to maintain numerical integrity of the circuit by preventing a portion of the system

from getting isolated after the valve is completely closed. The parameter value must be greater than 0. The default value is $1e-12 \text{ m}^2$.

Global Parameters

Parameters determined by the type of working fluid:

- **Fluid density**
- **Fluid kinematic viscosity**

Use the Hydraulic Fluid block or the Custom Hydraulic Fluid block to specify the fluid properties.

Ports

The block has the following ports:

A

Hydraulic conserving port associated with the valve inlet.

B

Hydraulic conserving port associated with the valve outlet.

S

Physical signal port that controls the gate displacement. The signal applied to this port is treated as translational motion, in meters.

Extended Capabilities

C/C++ Code Generation

Generate C and C++ code using Simulink® Coder™.

See Also

Ball Valve | Needle Valve | Poppet Valve | Pressure-Compensated Flow Control Valve

Topics

“Upgrading Simscape Fluids Models Containing Hydraulics (Isothermal) Blocks”

Introduced in R2011b

Gate Valve (IL)

Gate valve in an isothermal liquid system

Library: Simscape / Fluids / Isothermal Liquid / Valves & Orifices / Flow Control Valves



Description

The Gate Valve (IL) block models flow control by a gate valve in an isothermal liquid network. The valve comprises a round, sharp-edged orifice and a round gate with the same diameter. The gate opens or closes according to the displacement signal at port **S**. A positive signal retracts the gate and opens the valve.

Opening Area

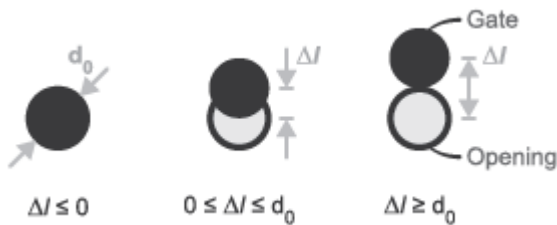

Gate Valve Opening Schematic

The area open to flow as the gate retracts is:

$$A_{open} = \frac{\pi d_0^2}{4} - A_{shielded},$$

where d_0 is the **Valve orifice diameter**. The area shielded by the gate in a partially open valve is:

$$A_{shielded} = \frac{d_0^2}{2} \cos^{-1}\left(\frac{\Delta l}{d_0}\right) - \frac{\Delta l}{2} \sqrt{d_0^2 - (\Delta l)^2},$$

where Δl is the gate displacement, which is the sum of the signal at port **S** and the **Gate position when fully covering orifice**.

If displacement exceeds the **Orifice diameter**, the valve area A_{open} is the sum of the maximum orifice area and the **Leakage area**:

$$A_{open} = \frac{\pi}{4} d_0^2 + A_{leak}.$$

For any combination of the signal at port **S** and the gate offset that is less than 0, the minimum valve area is the **Leakage area**.

Numerically-Smoothed Displacement

At the extremes of the gate displacement range, you can maintain numerical robustness in your simulation by adjusting the block **Smoothing factor**. When the smoothing factor is nonzero, a smoothing function is applied to every calculated displacement, but primarily influences the simulation at the extremes of this range.

The normalized gate displacement is:

$$\Delta \hat{l} = \frac{\Delta l}{\Delta l_{\max}},$$

where Δl_{\max} is the **Valve orifice diameter**.

The **Smoothing factor**, s , is applied to the normalized displacement:

$$\Delta \hat{l}_{\text{smoothed}} = \frac{1}{2} + \frac{1}{2} \sqrt{\Delta \hat{l}^2 + \left(\frac{s}{4}\right)^2} - \frac{1}{2} \sqrt{(\Delta \hat{l} - 1)^2 + \left(\frac{s}{4}\right)^2}.$$

The smoothed displacement is:

$$\Delta l_{\text{smoothed}} = \Delta \hat{l}_{\text{smoothed}} \Delta l_{\max}.$$

Mass Flow Rate Equation

Mass is conserved through the valve:

$$\dot{m}_A + \dot{m}_B = 0.$$

The mass flow rate through the valve is calculated as:

$$\dot{m} = \frac{C_d A_{\text{valve}} \sqrt{2\bar{\rho}}}{\sqrt{PR_{\text{loss}} \left(1 - \left(\frac{A_{\text{valve}}}{A_{\text{port}}}\right)^2\right)}} \frac{\Delta p}{[\Delta p^2 + \Delta p_{\text{crit}}^2]^{1/4}},$$

where:

- C_d is the **Discharge coefficient**.
- A_{valve} is the valve open area.
- A_{port} is the **Cross-sectional area at ports A and B**.
- $\bar{\rho}$ is the average fluid density.
- Δp is the valve pressure difference $p_A - p_B$.

The critical pressure difference, Δp_{crit} , is the pressure differential associated with the **Critical Reynolds number**, Re_{crit} , which is the flow regime transition point between laminar and turbulent flow:

$$\Delta p_{\text{crit}} = \frac{\pi \bar{\rho}}{8 A_{\text{valve}}} \left(\frac{\nu Re_{\text{crit}}}{C_d} \right)^2.$$

Pressure loss describes the reduction of pressure in the valve due to a decrease in area. PR_{loss} is calculated as:

$$PR_{\text{loss}} = \frac{\sqrt{1 - \left(\frac{A_{\text{valve}}}{A_{\text{port}}}\right)^2 (1 - C_d^2)} - C_d \frac{A_{\text{valve}}}{A_{\text{port}}}}{\sqrt{1 - \left(\frac{A_{\text{valve}}}{A_{\text{port}}}\right)^2 (1 - C_d^2)} + C_d \frac{A_{\text{valve}}}{A_{\text{port}}}}$$

Pressure recovery describes the positive pressure change in the valve due to an increase in area. If you do not wish to capture this increase in pressure, set **Pressure recovery** to Off. In this case, PR_{loss} is 1.

Ports

Conserving

A – Liquid port

isothermal liquid

Liquid entry or exit port to the valve.

B – Liquid port

isothermal liquid

Liquid entry or exit port to the valve.

Input

S – Gate displacement, m

physical signal

Gate displacement, in m, specified as a physical signal. A positive signal retracts the gate and opens the valve.

Parameters

Valve orifice diameter – Orifice diameter

5e-3 m² (default) | positive scalar

Valve open-area diameter.

Gate position when fully covering orifice – Gate offset

0 m (default) | positive scalar

Gate offset when the valve is closed. A positive, nonzero value indicates a partially open valve. A negative, nonzero value indicates an overlapped valve that remains closed for an initial displacement set by the physical signal at port **S**.

Leakage area – Gap area when in fully closed position

1e-10 m² (default) | positive scalar

Sum of all gaps when the valve is in the fully closed position. Any area smaller than this value is saturated to the specified leakage area. This contributes to numerical stability by maintaining continuity in the flow.

Cross-sectional area at ports A and B – Orifice area at conserving ports

inf m² (default) | positive scalar

Areas at the entry and exit ports **A** and **B**, which are used in the pressure-flow rate equation that determines the mass flow rate through the orifice.

Discharge coefficient – Discharge coefficient

0.64 (default) | positive scalar

Correction factor accounting for discharge losses in theoretical flows. The default discharge coefficient for a valve in Simscape Fluids is 0.64.

Critical Reynolds number – Upper Reynolds number limit for laminar flow

150 (default) | positive scalar

Upper Reynolds number limit for laminar flow through the valve.

Smoothing factor – Numerical smoothing factor

0.01 (default) | positive scalar in the range [0,1]

Continuous smoothing factor that introduces a layer of gradual change to the flow response when the valve is in near-open or near-closed positions. Set this value to a nonzero value less than one to increase the stability of your simulation in these regimes.

Pressure recovery – Whether to account for pressure increase in area expansions

Off (default) | On

Whether to account for pressure increase when fluid flows from a region of smaller cross-sectional area to a region of larger cross-sectional area.

See Also

Needle Valve (IL) | Poppet Valve (IL) | Orifice (IL)

Introduced in R2020a

Gate Valve (G)

Valve with sliding gate as control element

Library: Simscape / Fluids / Gas / Valves & Orifices / Flow Control
Valves



Description

The Gate Valve (G) block models an orifice with a translating gate (or *sluice*) as a flow control mechanism. The gate is circular and constrained by the groove of its seat to slide perpendicular to the flow. The seat is annular and its bore, part of the orifice through which the flow must pass, is sized to match the gate. The overlap of the two—the gate and the bore—determines the opening area of the valve.

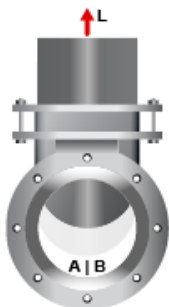

Gate valve with conical seat

The flow can be laminar or turbulent, and it can reach (up to) sonic speeds. This happens at the vena contracta, a point just past the throat of the valve where the flow is both its narrowest and fastest. The flow then chokes and its velocity saturates, with a drop in downstream pressure no longer sufficing to increase its velocity. Choking occurs when the back-pressure ratio hits a critical value characteristic of the valve. Supersonic flow is not captured by the block.

Gate valves are generally quick-opening. They are most sensitive to gate displacement near the closed position, where a small displacement translates into a disproportionately large change in opening area. Valves of this sort have too high a gain in that region to effectively throttle, or modulate, flow. They more commonly serve as binary on/off switches—often as shutoff and isolation valves—to open and close gas circuits.

Gate Mechanics

In a real valve, the gate connects by a gear mechanism to a handle. When the handle is turned from a fully closed position—by hand, say, or with the aid of an electrical actuator—the gate rises from the bore, progressively opening the valve up to a maximum. Hard stops keep the disk from breaching its minimum and maximum positions.

The block captures the motion of the disk but not the detail of its mechanics. The motion you specify as a normalized displacement at port **L**. The input (a physical signal) carries the fraction of the instantaneous displacement over its value in the fully open valve. It helps to think of displacements directly as fractions, rather than as lengths to be converted to (and from) fractions.

If the action of the handle and hard stop matter in your model, you can capture these elements separately using other Simscape blocks. A Simscape Mechanical subsystem makes a good source for the gate displacement signal. In many cases, however, it suffices to know what displacement to impart to the disk. You can usually ignore the mechanics of the valve.

Gate Position

The displacement signal allows the block to compute the instantaneous position of the gate, from which the opening of the valve follows. The opening is easily understood as a flow area but, for ease of modeling, it is often best expressed as a flow coefficient or sonic conductance. (The "ease of modeling" depends on the data available from the manufacturer.)

The position and displacement variables measure different things. The (instantaneous) position gives the distance of the gate to its resting place on the seat; the displacement gives only that distance to its normal (unactuated) position. The normal position, a fixed coordinate, need not be zero: the gate can be installed so that it is normally off-center with respect to the orifice. (The valve is then partially open even when it is disconnected and therefore idle.)

The normal distance between the gate and its centered position gives the *valve lift control offset*, specified in the block parameter of the same name. Think of it as the permanent displacement given to the gate while assembling the valve. The variable displacement from port **L**, on the other hand, captures the motion of the gate during operation of the valve, after it has been assembled and installed. The instantaneous position of the gate is the sum of the two:

$$h(L) = L + h_0,$$

where:

- h is the instantaneous position of the gate, normalized against its maximum value. This variable can range from θ to 1, with θ giving a maximally closed valve and 1 a fully open valve. If the calculation should return a number outside of this range, that number is set to the nearest bound (θ if the result is negative, 1 otherwise). In other words, the normalized position *saturates* at θ and 1.
- L is the variable displacement of the gate, normalized against the maximum position of the same. This variable is obtained from the physical signal at port **L**. There are no restrictions on its value. You can make it smaller than θ or greater than 1, for example, to compensate for an equally extreme valve offset.
- h_0 is the fixed offset of the gate relative to its seat in the normal position (when the valve is disconnected and free of inputs). Its value too is normalized against the maximum position of the gate, though there is no requirement that it lie between θ and 1.

Numerical Smoothing

The normalized position, h , spans three regions. At a sufficiently small displacement, it saturates at θ and the valve is fully closed. At a sufficiently large displacement, it saturates at 1 and the valve is fully open. In between, it varies linearly between its saturation bounds, giving a valve that is partially open.

The transitions between the regions are sharp and their slopes discontinuous. These pose a challenge to variable-step solvers (the sort commonly used with Simscape models). To precisely capture discontinuities, referred to in some contexts as *zero crossing events*, the solver must reduce its time step, pausing briefly at the time of the crossing in order to recompute its Jacobian matrix (a representation of the dependencies between the state variables of the model and their time derivatives).

This solver strategy is efficient and robust when discontinuities are present. It makes the solver less prone to convergence errors—but it can considerably extend the time needed to finish the simulation run, perhaps excessively so for practical use in real-time simulation. An alternative approach, used here, is to remove the discontinuities altogether.

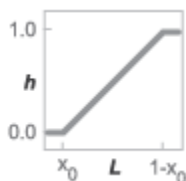

Normalized position with sharp transitions

To remove the slope discontinuities, the block smoothes them over a small portion of the opening curve. The smoothing, which adds a slight distortion at each transition, ensures that the valve eases into its limiting positions rather than snap (abruptly) into them. The smoothing is optional: you can disable it by setting its time scale to zero. The shape and scale of the smoothing, when applied, derives in part from the cubic polynomials:

$$\lambda_L = 3\bar{h}_L^2 - 2\bar{h}_L^3$$

and

$$\lambda_R = 3\bar{h}_R^2 - 2\bar{h}_R^3,$$

where

$$\bar{h}_L = \frac{h}{\Delta h^*}$$

and

$$\bar{h}_R = \frac{h - (1 - \Delta h^*)}{\Delta h^*}.$$

In the equations:

- λ_L is the smoothing expression for the transition from the maximally closed position.
- λ_R is the smoothing expression for the transition from the fully open position.
- Δh^* is the (unitless) characteristic width of the smoothing region:

$$\Delta h^* = \frac{1}{2}f^*,$$

where f^* is a smoothing factor valued between 0 and 1 and obtained from the block parameter of the same name.

When the smoothing factor is 0, the normalized gate position stays in its original form—no smoothing applied—and its transitions remain abrupt. When it is 1, the smoothing spans the whole of the gate's travel range (with the normalized gate position taking the shape of an S-curve).

At intermediate values, the smoothing is limited to a fraction of that range. A value of 0.5, for example, will smooth the transitions over a quarter of the travel range on each side (for a total smooth region of half that range).

The smoothing adds two new regions to the normalized gate position function—one for the smooth transition on the left, another for that on the right, giving a total of five regions. These are expressed in the piecewise function:

$$h^* = \begin{cases} 0, & h \leq 0 \\ h\lambda_L, & 0 < h < \Delta h^* \\ h, & \Delta h^* \leq h \leq 1 - \Delta h^* \\ h(1 - \lambda_R) + \lambda_R, & 1 - \Delta h^* < h < 1 \\ 1 & h \geq 1 \end{cases}$$

where h^* is the smoothed valve opening area. The figure shows the effect of smoothing on the sharpness of the transitions.

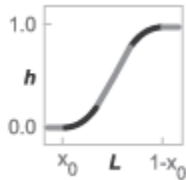

Opening Area

The opening area of the valve is that of its bore adjusted for the instantaneous overlap of the gate—a function of its displacement—and leakage between its ports:

$$S = \frac{\pi D^2}{4} h - S_C + S_{\text{Leak}}$$

where:

- S is the instantaneous valve opening area. This area is later smoothed to remove derivative discontinuities at the limiting valve positions.
- D is the common diameter of the gate and its bore (the two being identical). This value is obtained from the **Orifice diameter** block parameter.
- S_C is the area of overlap between the gate and bore, computed as a function of the gate position, h (which in turn depends on the gate displacement signal, L):

$$S_C = \frac{D^2}{2} \arccos(h) - \frac{hD}{2} \sqrt{D^2 - h^2 D^2},$$

- S_{Leak} is the residual area that remains open after the valve has closed to its maximum. This area can be due to bore tolerances, surface defects, or an imperfect seal between the gate and its seat. This area is obtained from the **Leakage area** block parameter.

The figure shows a front view of the valve maximally closed (left), partially open (middle), and fully open (right). The parameters and variables used in the opening area calculation are shown.

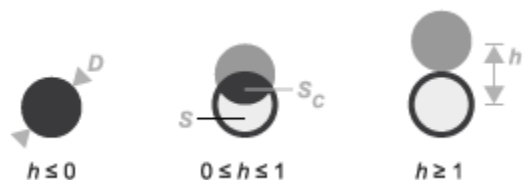

Sonic Conductance

As the opening area varies during simulation, so does the mass flow rate through the valve. The relationship between the two variables, however, is indirect. The mass flow rate is defined in terms of the valve's sonic conductance and it is this quantity that the opening area truly determines.

Sonic conductance, if you are unfamiliar with it, describes the ease with which a gas will flow when it is choked—when its velocity is at its theoretical maximum (the local speed of sound). Its measurement and calculation are covered in detail in the ISO 6358 standard (on which this block is based).

Only one value is commonly reported in valve data sheets: one taken at steady state in the fully open position. This is the same specified in the block dialog box (when the **Valve parameterization** setting is **Sonic conductance**). For values across the opening range of the valve, this maximum is scaled by the (normalized) valve opening area:

$$C(S) = \frac{S}{S_{\text{Max}}} C_{\text{Max}},$$

where C is sonic conductance and the subscript **Max** denotes the specified (manufacturer's) value. The sonic conductance varies linearly between C_{Max} in the fully open position and $S_{\text{Leak}} \div S_{\text{Max}} \times C_{\text{Max}}$ in the maximally closed position—a value close to zero and due only to internal leakage between the ports.

Other Parameterizations

Because sonic conductance may not be available (or the most convenient choice for your model), the block provides several equivalent parameterizations. Use the **Valve parameterization** drop-down list to select the best for the data at hand. The parameterizations are:

- Compute from geometry
- Sonic conductance
- Cv coefficient (USCS)
- Kv coefficient (SI)

The parameterizations differ only in the data that they require of you. Their mass flow rate calculations are still based on sonic conductance. If you select a parameterization other than **Sonic conductance**, then the block converts the alternate data—the (computed) opening area or a (specified) flow coefficient—into an equivalent sonic conductance.

Flow Coefficients

The flow coefficients measure what is, at bottom, the same quantity—the flow rate through the valve at some agreed-upon temperature and pressure differential. They differ only in the standard conditions used in their definition and in the physical units used in their expression:

- C_v is measured at a generally accepted temperature of 60 °F and pressure drop of 1 PSI; it is expressed in imperial units of US gpm. This is the flow coefficient used in the model when the **Valve parameterization** block parameter is set to **Cv coefficient (USCS)**.
- K_v is measured at a generally accepted temperature of 15 °C and pressure drop of 1 bar; it is expressed in metric units of m³/h. This is the flow coefficient used in the model when the **Valve parameterization** block parameter is set to **Kv coefficient (SI)**.

Sonic Conductance Conversions

If the valve parameterization is set to **Cv Coefficient (USCS)**, the sonic conductance is computed at the maximally closed and fully open valve positions from the **Cv coefficient (SI) at maximum flow** and **Cv coefficient (SI) at leakage flow** block parameters:

$$C = (4 \times 10^{-8} C_v) m^3 / (sPa),$$

where C_v is the flow coefficient value at maximum or leakage flow. The subsonic index, m , is set to 0.5 and the critical pressure ratio, b_{cr} , is set to 0.3. (These are used in the mass flow rate calculations given in the Momentum Balance section.)

If the **Kv coefficient (SI)** parameterization is used instead, the sonic conductance is computed at the same valve positions (maximally closed and fully open) from the **Kv coefficient (USCS) at maximum flow** and **Kv coefficient (USCS) at leakage flow** block parameters:

$$C = (4.758 \times 10^{-8} K_v) m^3 / (sPa),$$

where K_v is the flow coefficient value at maximum or leakage flow. The subsonic index, m , is set to 0.5 and the critical pressure ratio, b_{cr} , is set to 0.3.

For the **Restriction area** parameterization, the sonic conductance is computed (at the same valve positions) from the **Maximum opening area**, and **Leakage area** block parameters:

$$C = (0.128 \times 4S_R / \pi) L / (sbar),$$

where S_R is the opening area at maximum or leakage flow. The subsonic index, m , is set to 0.5 while the critical pressure ratio, b_{cr} is computed from the expression:

$$0.41 + 0.272 \left(\frac{S_R}{S_P} \right)^{0.25},$$

where the subscript P refers to the inlet of the connecting pipe.

Momentum Balance

The causes of those pressure losses incurred in the passages of the valve are ignored in the block. Whatever their natures—sudden area changes, flow passage contortions—only their cumulative effect is considered during simulation. This effect is assumed to reflect entirely in the sonic conductance of the valve (or in the data of the alternate valve parameterizations).

Mass Flow Rate

When the flow is choked, the mass flow rate is a function of the sonic conductance of the valve and of the thermodynamic conditions (pressure and temperature) established at the inlet. The function is linear with respect to pressure:

$$\dot{m}_{\text{ch}} = C\rho_0 p_{\text{in}} \sqrt{\frac{T_0}{T_{\text{in}}}},$$

where:

- C is the sonic conductance inside the valve. Its value is obtained from the block parameter of the same name or by conversion of other block parameters (the exact source depending on the **Valve parameterization** setting).
- ρ is the gas density, here at standard conditions (subscript 0), obtained from the **Reference density** block parameter.
- p is the absolute gas pressure, here corresponding to the inlet (in).
- T is the gas temperature at the inlet (in) or at standard conditions (0), the latter obtained from the **Reference temperature** block parameter.

When the flow is subsonic, and therefore no longer choked, the mass flow rate becomes a nonlinear function of pressure—both that at the inlet as well as the reduced value at the outlet. In the turbulent flow regime (with the outlet pressure contained in the back-pressure ratio of the valve), the mass flow rate expression is:

$$\dot{m}_{\text{tur}} = C\rho_0 p_{\text{in}} \sqrt{\frac{T_0}{T_{\text{in}}}} \left[1 - \left(\frac{p_r - b_{\text{cr}}}{1 - b_{\text{cr}}} \right)^{2m} \right],$$

where:

- p_r is the back-pressure ratio, or that between the outlet pressure (p_{out}) and the inlet pressure (p_{in}):

$$P_r = \frac{p_{\text{out}}}{p_{\text{in}}}$$

- b_{cr} is the critical pressure ratio at which the flow becomes choked. Its value is obtained from the block parameter of the same name or by conversion of other block parameters (the exact source depending on the **Valve parameterization** setting).
- m is the *subsonic index*, an empirical coefficient used to more accurately characterize the behavior of subsonic flows. Its value is obtained from the block parameter of the same name or by conversion of other block parameters (the exact source depending on the **Valve parameterization** setting).

When the flow is laminar (and still subsonic), the mass flow rate expression changes to:

$$\dot{m}_{\text{lam}} = C\rho_0 p_{\text{in}} \left[\frac{1 - p_r}{1 - b_{\text{lam}}} \right] \sqrt{\frac{T_0}{T_{\text{in}}}} \left[1 - \left(\frac{b_{\text{lam}} - b_{\text{cr}}}{1 - b_{\text{cr}}} \right)^{2m} \right]$$

where b_{lam} is the critical pressure ratio at which the flow transitions between laminar and turbulent regimes (obtained from the **Laminar flow pressure ratio** block parameter). Combining the mass flow rate expressions into a single (piecewise) function, gives:

$$\dot{m} = \begin{cases} \dot{m}_{\text{lam}}, & b_{\text{lam}} \leq p_r < 1 \\ \dot{m}_{\text{tur}}, & b_{\text{Cr}} \leq p_r < p_{\text{lam}}, \\ \dot{m}_{\text{ch}}, & p_r < b_{\text{Cr}} \end{cases}$$

with the top row corresponding to subsonic and laminar flow, the middle row to subsonic and turbulent flow, and the bottom row to choked (and therefore sonic) flow.

Mass Balance

The volume of fluid inside the valve, and therefore the mass of the same, is assumed to be very small and it is, for modeling purposes, ignored. As a result, no amount of gas can accumulate there. By the principle of conservation of mass, the mass flow rate into the valve through one port must therefore equal that out of the valve through the other port:

$$\dot{m}_A + \dot{m}_B = 0,$$

where \dot{m} is defined as the mass flow rate *into* the valve through port **A** or **B**. Note that in this block the flow can reach but not exceed sonic speeds.

Energy Balance

The valve is modeled as an adiabatic component. No heat exchange can occur between the gas and the wall that surrounds it. No work is done on or by the gas as it traverses from inlet to outlet. With these assumptions, energy can flow by advection only, through ports **A** and **B**. By the principle of conservation of energy, the sum of the port energy flows must then always equal zero:

$$\phi_A + \phi_B = 0,$$

where ϕ is defined as the energy flow rate *into* the valve through one of the ports (**A** or **B**).

Ports

Input

L – Valve control signal, unitless

physical signal

Input port through which to specify the relative displacement of the gate (as a fraction of its maximum). The block uses this input to compute the position of the gate—and from it, the mass flow rate through the valve.

The gate position is the sum of this signal and the valve lift control offset (specified in the block parameter of the same name). This position should range between 0 for a maximally closed valve to 1 for a fully open valve.

The control signal range is enforced by saturating the calculated gate position at these limits. If no control signal is provided, the gate position is fixed to the specified valve lift control offset.

Conserving

A – Valve entrance

gas

Opening through which the working fluid can enter or exit the valve. The direction of flow depends on the pressure differential established across the valve. Both forward and backward directions are allowed.

B – Valve entrance

gas

Opening through which the working fluid can enter or exit the valve. The direction of flow depends on the pressure differential established across the valve. Both forward and backward directions are allowed.

Parameters

Orifice diameter – Diameter of the bore of the valve

0.01 m (default) | positive scalar in units of length

Diameter of the bore of the valve and of the gate that controls the opening area. The orifice is assumed to be constant in cross section throughout its length (from one port to the other).

Gate displacement fraction offset – Distance of the gate from its centered position

0 (default) | unitless scalar

Displacement of the gate from the maximally closed position, expressed as a fraction of the travel range for the same. This displacement is the position of the gate in the normal valve position, when no control input is provided or when that input is zero. The instantaneous gate position is calculated during simulation as the sum of this offset and the control signal specified at port L. The valve is partially open in its normal position when the offset is a fraction between 0 and 1.

Valve parameterization – Method by which to characterize the opening of the valve

Sonic conductance (default) | Cv coefficient (USCS) | Kv coefficient (SI) | Restriction area

Choice of ISO method to use in the calculation of mass flow rate. All calculations are based on the **Sonic conductance** parameterization; if a different option is selected, the data specified in converted into equivalent sonic conductance, critical pressure ratio, and subsonic index. See the block description for more information on the conversion.

This parameter determines which measures of valve opening you must specify—and therefore which of those measures appear as parameters in the block dialog box.

Sonic conductance at maximum flow – Measure of maximum flow rate at reference upstream conditions

1.6 l/s/bar (default) | positive scalar in units of volume/time/pressure

Equivalent measure of the maximum flow rate allowed through the valve at some reference inlet conditions, generally those outlined in ISO 8778. The flow is at a maximum when the valve is fully open and the flow velocity is choked (it being saturated at the local speed of sound). This is the value generally reported by manufacturers in technical data sheets.

Sonic conductance is defined as the ratio of the mass flow rate through the valve to the product of the pressure and density upstream of the valve inlet. This parameter is often referred to in the literature as the *C-value*.

Dependencies

This parameter is active and exposed in the block dialog box when the **Valve parameterization** setting is **Sonic conductance**.

Critical pressure ratio — Back-pressure ratio, at reference upstream conditions, at which the flow rate is a maximum

0.3 (default) | positive unitless scalar

Ratio of downstream to upstream absolute pressures at which the flow becomes choked (and its velocity becomes saturated at the local speed of sound). This parameter is often referred to in the literature as the *b-value*. Enter a number greater than or equal to zero and smaller than the **Laminar flow pressure ratio** block parameter.

Dependencies

This parameter is active and exposed in the block dialog box when the **Valve parameterization** setting is **Sonic conductance**.

Subsonic index — Exponent used to more accurately characterize flow in the subsonic regime

0.5 (default) | positive unitless scalar

Empirical exponent used to more accurately calculate the mass flow rate through the valve when the flow is subsonic. This parameter is sometimes referred to as the *m-index*. Its value is approximately 0.5 for valves (and other components) whose flow paths are fixed.

Dependencies

This parameter is active and exposed in the block dialog box when the **Valve parameterization** setting is **Sonic conductance**.

Cv coefficient (USCS) at maximum flow — Flow coefficient of the fully open valve expressed in US customary units

0.4 (default) | positive scalar in units of ft³/min

Flow coefficient of the fully open valve, expressed in the US customary units of ft³/min (as described in NFPA T3.21.3). This parameter measures the relative ease with which the gas will traverse the valve when driven by a given pressure differential. This is the value generally reported by manufacturers in technical data sheets.

Dependencies

This parameter is active and exposed in the block dialog box when the **Valve parameterization** setting is **Cv coefficient (USCS)**.

Kv coefficient (SI) at maximum flow — Flow coefficient of the fully open valve expressed in SI units

0.3 (default) | positive scalar in units of m³/hr

Flow coefficient of the fully open valve, expressed in the SI units of m³/hr. This parameter measures the relative ease with which the gas will traverse the valve when driven by a given pressure differential. This is the value generally reported by manufacturers in technical data sheets.

Dependencies

This parameter is active and exposed in the block dialog box when the **Valve parameterization** setting is **Kv coefficient (SI)**.

Leakage area — Opening area in the maximally closed position due to sealing imperfections

1e-12 m² (default) | positive scalar in units of area

Opening area of the valve in the maximally closed position, when only internal leakage between the ports remains. This parameter serves primarily to ensure that closure of the valve does not cause portions of the gas network to become isolated (a condition known to cause problems in simulation). The exact value specified here is less important than its being a (very small) number greater than zero.

Dependencies

This parameter is active and exposed in the block dialog box when the **Valve parameterization** setting is **Opening area**.

Cross-sectional area at ports A and B — Area normal to the flow path at the valve ports

0.01 m² (default) | positive scalar in units of area

Area normal to the flow path at the valve ports. The ports are assumed to be the same in size. The flow area specified here should ideally match those of the inlets of adjoining components.

Laminar flow pressure ratio — Pressure ratio at which the flow transitions between laminar and turbulent

0.999 (default) | positive unitless scalar

Pressure ratio at which the flow transitions between laminar and turbulent flow regimes. The pressure ratio is the fraction of the absolute pressure downstream of the valve over that just upstream of it. The flow is laminar when the actual pressure ratio is above the threshold specified here and turbulent when it is below. Typical values range from 0.995 to 0.999.

Reference temperature — ISO 8778 reference temperature

293.15 K (default) | scalar in units of temperature

Temperature at standard reference atmosphere, defined as 293.15 K in ISO 8778.

Reference density — ISO 8778 reference density

1.185 (default) | positive scalar in units of mass/volume

Density at standard reference atmosphere, defined as 1.185 kg/m³ in ISO 8778.

Smoothing factor — Amount of smoothing to apply to the valve opening area function

0 (default)

Amount of smoothing to apply to the opening area function of the valve. This parameter determines the widths of the regions to be smoothed—one located at the fully open position, the other at the fully closed position.

The smoothing superposes on each region of the opening area function a nonlinear segment (a third-order polynomial function, from which the smoothing arises). The greater the value specified here, the greater the smoothing is, and the broader the nonlinear segments become.

At the default value of θ , no smoothing is applied. The transitions to the maximally closed and fully open positions then introduce discontinuities (associated with zero-crossings), which tend to slow down the rate of simulation.

Extended Capabilities

C/C++ Code Generation

Generate C and C++ code using Simulink® Coder™.

See Also

Variable Orifice ISO 6358 (G) | Ball Valve (G)

Introduced in R2018b

Gate Valve (TL)

Flow control valve actuated by transverse motion of circular gate

Library: Simscape / Fluids / Thermal Liquid / Valves & Orifices / Flow Control Valves



Description

The Gate Valve (TL) block represents a flow control valve with a circular opening and a circular gate. The gate moves in a direction orthogonal to the fluid flow. The opening and gate are equal in diameter. The figure shows a schematic of the gate valve in three different positions—closed, partially open, and fully open.

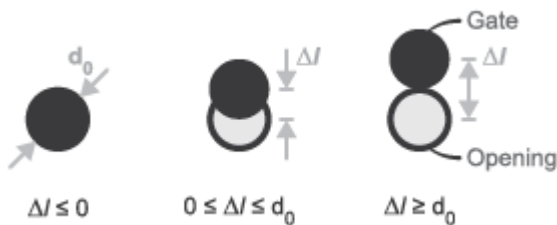

Gate Valve in Different Positions

A smoothing function allows the valve opening area to change smoothly between the fully closed and fully open positions. The smoothing function does this by removing the abrupt opening area changes at the zero and maximum ball positions. The figure shows the effect of smoothing on the valve opening area curve.

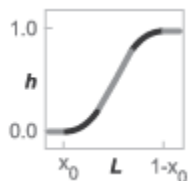

Opening-Area Curve Smoothing

Valve Opening Area

The block computes the valve opening area directly from valve geometry parameters using the expression

$$A = \frac{\pi d_0^2}{4} - A_{Covered},$$

where:

- A is the valve opening area.
- d_0 is the valve orifice diameter.
- $A_{Covered}$ is the portion of the valve orifice area covered by the gate:

$$A_{Covered} = \frac{d_0^2}{2} \arccos\left(\frac{\Delta l}{d_0}\right) - \frac{\Delta l}{2} \sqrt{d_0^2 - (\Delta l)^2}$$

- Δl is the net displacement of the gate center relative to the orifice center.

$$\Delta l = \begin{cases} 0, & (x_0 + S_d) \leq 0 \\ d_0, & (x_0 + S_d) \geq d_0, \\ (x_0 + S), & \text{Else} \end{cases}$$

- x_0 is the **Gate displacement offset** specified in the block dialog box.
- S_d is the gate displacement specified through physical signal input port S.

The valve opening expressions introduce undesirable discontinuities at the fully open and fully closed positions. The block eliminates these discontinuities using polynomial expressions that smooth the transitions to and from the fully open and fully closed positions. The valve smoothing expressions are

$$\lambda_L = 3\overline{\Delta l}_L^2 - 2\overline{\Delta l}_L^3$$

and

$$\lambda_R = 3\overline{\Delta l}_R^2 - 2\overline{\Delta l}_R^3$$

where:

$$\overline{\Delta l}_L = \frac{\Delta l}{\Delta l_{smooth}}$$

and

$$\overline{\Delta l}_R = \frac{\Delta l - (d_0 - \Delta l_{smooth})}{d_0 - (d_0 - \Delta l_{smooth})}$$

In the equations:

- λ_L is the smoothing expression for the fully closed portion of the valve opening curve.
- λ_R is the smoothing expression applied to the fully open portion of the valve opening curve.
- Δl_{smooth} is the gate displacement smoothing region:

$$\Delta l_{smooth} = f_{smooth} \frac{d_0}{2},$$

where f_{smooth} is a smoothing factor between 0 and 1.

The smoothed valve opening area is given by the piecewise conditional expression

$$S_R = \begin{cases} S_{Leak}, & \Delta l \leq 0 \\ S_{Leak}(1 - \lambda_L) + (A + S_{Leak})\lambda_L, & \Delta l < \Delta l_{smooth} \\ A + S_{Leak}, & \Delta l \leq d_0 - \Delta l_{smooth}, \\ (A + S_{Leak})(1 - \lambda_R) + (S_{Leak} + S_{Max})\lambda_R, & \Delta l < d_0 \\ S_{Leak} + S_{Max}, & \Delta l \geq d_0 \end{cases}$$

where:

- S_R is the smoothed valve opening area.
- S_{Leak} is the valve leakage area.
- S_{Max} is the maximum valve opening area:

$$S_{Max} = \frac{\pi d_0^2}{4}.$$

Mass Balance

The mass conservation equation in the valve is

$$\dot{m}_A + \dot{m}_B = 0,$$

where:

- \dot{m}_A is the mass flow rate into the valve through port A.
- \dot{m}_B is the mass flow rate into the valve through port B.

Energy Balance

The energy conservation equation in the valve is

$$\phi_A + \phi_B = 0,$$

where:

- ϕ_A is the energy flow rate into the valve through port A.
- ϕ_B is the energy flow rate into the valve through port B.

Momentum Balance

The momentum conservation equation in the valve is

$$p_A - p_B = \frac{\dot{m}\sqrt{\dot{m}^2 + \dot{m}_{cr}^2}}{2\rho_{Avg}C_d^2S^2} \left[1 - \left(\frac{S_R}{S} \right)^2 \right] PR_{Loss},$$

where:

- p_A and p_B are the pressures at port A and port B.
- \dot{m} is the mass flow rate.
- \dot{m}_{cr} is the critical mass flow rate:

$$\dot{m}_{cr} = Re_{cr} \rho_{Avg} \sqrt{\frac{\pi}{4}} S_R.$$

- ρ_{Avg} is the average liquid density.
- C_d is the discharge coefficient.
- S is the valve inlet area.
- PR_{Loss} is the pressure ratio:

$$PR_{Loss} = \frac{\sqrt{1 - (S_R/S)^2(1 - C_d^2)} - C_d(S_R/S)}{\sqrt{1 - (S_R/S)^2(1 - C_d^2)} + C_d(S_R/S)}.$$

Ports

- A — Thermal liquid conserving port representing valve inlet A
- B — Thermal liquid conserving port representing valve inlet B
- S — Physical signal input port for the control member displacement

Parameters

Parameters Tab

Orifice diameter

Diameter of the valve flow area in the fully open position. The default value is 7e-3 m.

Gate displacement offset

Gate offset from the zero position. The instantaneous gate displacement is the sum of the gate offset and input signal S. The default value is 0 m.

Leakage area

Aggregate area of all fluid leaks in the valve. The leakage area helps to prevent numerical issues due to isolated fluid network sections. For numerical robustness, set this parameter to a nonzero value. The default value is 1e-12.

Smoothing factor

Portion of the opening-area curve to smooth expressed as a fraction. Smoothing eliminates discontinuities at the minimum and maximum flow valve positions. The smoothing factor must be between 0 and 1. Enter a value of 0 for zero smoothing. Enter a value of 1 for full-curve smoothing. The default value is 0.01.

Cross-sectional area at ports A and B

Flow area at the valve inlets. The inlets are assumed equal in size. The default value is 0.01 m².

Characteristic longitudinal length

Approximate length of the valve. This parameter provides a measure of the longitudinal scale of the valve. The default value is 0.1 m.

Discharge coefficient

Semi-empirical parameter commonly used as a measure of valve performance. The discharge coefficient is defined as the ratio of the actual mass flow rate through the valve to its theoretical value.

The block uses this parameter to account for the effects of valve geometry on mass flow rates. Textbooks and valve data sheets are common sources of discharge coefficient values. By definition, all values must be greater than 0 and smaller than 1. The default value is 0.7.

Critical Reynolds number

Reynolds number corresponding to the transition between laminar and turbulent flow regimes. The flow through the valve is assumed laminar below this value and turbulent above it. The appropriate values to use depend on the specific valve geometry. The default value is 12.

Variables Tab**Mass flow rate into port A**

Mass flow rate into the component through port **A** at the start of simulation. The default value is 1 kg/s.

Extended Capabilities**C/C++ Code Generation**

Generate C and C++ code using Simulink® Coder™.

See Also

Ball Valve (TL)

Introduced in R2016a

Gradual Area Change

Gradual enlargement or contraction



Library

Local Hydraulic Resistances

Description

The Gradual Area Change block represents a local hydraulic resistance, such as a gradual cross-sectional area change. The resistance represents a gradual enlargement (diffuser) if fluid flows from inlet to outlet, or a gradual contraction if fluid flows from outlet to inlet. The block is based on the Local Resistance block. It determines the pressure loss coefficient and passes its value to the underlying Local Resistance block. The block offers two methods of parameterization: by applying semi-empirical formulas (with a constant value of the pressure loss coefficient) or by table lookup for the pressure loss coefficient based on the Reynolds number.

If you choose to apply the semi-empirical formulas, you provide geometric parameters of the resistance, and the pressure loss coefficient is determined according to the A.H. Gibson equations (see [1] on page 1-820 and [2] on page 1-820):

$$K_{GE} = \begin{cases} K_{cor} \left(1 - \frac{A_s}{A_L}\right)^2 \cdot 2.6 \sin \frac{\alpha}{2} & \text{for } 0 < \alpha \leq 45^\circ \\ K_{cor} \left(1 - \frac{A_s}{A_L}\right)^2 & \text{for } 45^\circ < \alpha < 180^\circ \end{cases}$$

$$K_{GC} = \begin{cases} K_{cor} \cdot 0.5 \left(1 - \frac{A_s}{A_L}\right)^{0.75} \cdot 1.6 \sin \frac{\alpha}{2} & \text{for } 0 < \alpha \leq 45^\circ \\ K_{cor} \cdot 0.5 \left(1 - \frac{A_s}{A_L}\right)^{0.75} \cdot \sqrt{\sin \frac{\alpha}{2}} & \text{for } 45^\circ < \alpha < 180^\circ \end{cases}$$

where

K_{GE}	Pressure loss coefficient for the gradual enlargement, which takes place if fluid flows from inlet to outlet
K_{GC}	Pressure loss coefficient for the gradual contraction, which takes place if fluid flows from outlet to inlet
K_{cor}	Correction factor
A_s	Small area
A_L	Large area

α	Enclosed angle
----------	----------------

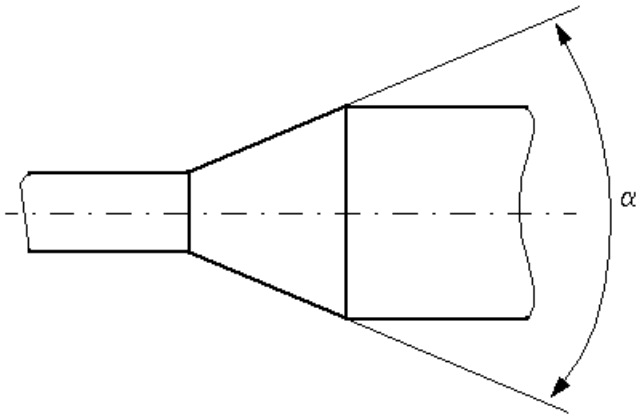

If you choose to specify the pressure loss coefficient by a table, you have to provide a tabulated relationship between the loss coefficient and the Reynolds number. In this case, the loss coefficient is determined by one-dimensional table lookup. You have a choice of two interpolation methods and two extrapolation methods.

The pressure loss coefficient, determined by either of the two methods, is then passed to the underlying Local Resistance block, which computes the pressure loss according to the formulas explained in the reference documentation for that block. The flow regime is checked in the underlying Local Resistance block by comparing the Reynolds number to the specified critical Reynolds number value, and depending on the result, the appropriate formula for pressure loss computation is used.

The Gradual Area Change block is bidirectional and computes pressure loss for both the direct flow (gradual enlargement) and return flow (gradual contraction). If the loss coefficient is specified by a table, the table must cover both the positive and the negative flow regions.

Connections A and B are conserving hydraulic ports associated with the block inlet and outlet, respectively.

The block positive direction is from port A to port B. This means that the flow rate is positive if fluid flows from A to B, and the pressure loss is determined as $p = p_A - p_B$.

Basic Assumptions and Limitations

- Fluid inertia is not taken into account.
- If you select parameterization by the table-specified relationship $K=f(Re)$, the flow is assumed to be turbulent.

Parameters

Model parameterization

Select one of the following methods for block parameterization:

- By semi-empirical formulas — Provide geometrical parameters of the resistance. This is the default method.

- **Tabulated data – loss coefficient vs. Reynolds number** — Provide tabulated relationship between the loss coefficient and the Reynolds number. The loss coefficient is determined by one-dimensional table lookup. You have a choice of two interpolation methods and two extrapolation methods. The table must cover both the positive and the negative flow regions.

Small diameter

Internal diameter of the small port, **A**. The default value is 0.01 m.

Large diameter

Internal diameter of the large port, **B**. The default value is 0.02 m. This parameter is used if **Model parameterization** is set to `By semi-empirical formulas`.

Cone angle

The enclosed angle. The default value is 30 deg. This parameter is used if **Model parameterization** is set to `By semi-empirical formulas`.

Correction coefficient

Correction factor used in the formula for computation of the loss coefficient. The default value is 1. This parameter is used if **Model parameterization** is set to `By semi-empirical formulas`.

Laminar transition specification

If **Model parameterization** is set to `By semi-empirical formulas`, select how the block transitions between the laminar and turbulent regimes:

- **Pressure ratio** — The transition from laminar to turbulent regime is smooth and depends on the value of the **Laminar flow pressure ratio** parameter. This method provides better simulation robustness.
- **Reynolds number** — The transition from laminar to turbulent regime is assumed to take place when the Reynolds number reaches the value specified by the **Critical Reynolds number** parameter.

Laminar flow pressure ratio

Pressure ratio at which the flow transitions between laminar and turbulent regimes. The default value is 0.999. This parameter is visible only if the **Laminar transition specification** parameter is set to `Pressure ratio`.

Critical Reynolds number

The maximum Reynolds number for laminar flow. The value of the parameter depends on the orifice geometrical profile. You can find recommendations on the parameter value in hydraulics textbooks. The default value is 350. This parameter is visible only if the **Laminar transition specification** parameter is set to `Reynolds number`.

Reynolds number vector

Specify the vector of input values for Reynolds numbers as a one-dimensional array. The input values vector must be strictly increasing. The values can be nonuniformly spaced. The minimum number of values depends on the interpolation method: you must provide at least two values for linear interpolation, at least three values for smooth interpolation. The default values are [-4000, -3000, -2000, -1000, -500, -200, -100, -50, -40, -30, -20, -15, -10, 10, 20, 30, 40, 50, 100, 200, 500, 1000, 2000, 4000, 5000, 10000]. This parameter is used if **Model parameterization** is set to `By loss coefficient vs. Re table`.

Loss coefficient vector

Specify the vector of the loss coefficient values as a one-dimensional array. The loss coefficient vector must be of the same size as the Reynolds numbers vector. The default values are [0.25, 0.3, 0.65, 0.9, 0.65, 0.75, 0.90, 1.15, 1.35, 1.65, 2.3, 2.8, 3.10, 5, 2.7, 1.8, 1.46, 1.3, 0.9, 0.65, 0.42, 0.3, 0.20, 0.40, 0.42, 0.25]. This parameter is used if **Model parameterization** is set to **By loss coefficient vs. Re table**.

Interpolation method

Select one of the following interpolation methods for approximating the output value when the input value is between two consecutive grid points:

- **Linear** — Select this option to get the best performance.
- **Smooth** — Select this option to produce a continuous curve with continuous first-order derivatives.

For more information on interpolation algorithms, see the PS Lookup Table (1D) block reference page. This parameter is used if **Model parameterization** is set to **By loss coefficient vs. Re table**.

Extrapolation method

Select one of the following extrapolation methods for determining the output value when the input value is outside the range specified in the argument list:

- **Linear** — Select this option to produce a curve with continuous first-order derivatives in the extrapolation region and at the boundary with the interpolation region.
- **Nearest** — Select this option to produce an extrapolation that does not go above the highest point in the data or below the lowest point in the data.

For more information on extrapolation algorithms, see the PS Lookup Table (1D) block reference page. This parameter is used if **Model parameterization** is set to **By loss coefficient vs. Re table**.

Restricted Parameters

When your model is in Restricted editing mode, you cannot modify the following parameters:

- **Model parameterization**
- **Interpolation method**
- **Extrapolation method**

All other block parameters are available for modification. The actual set of modifiable block parameters depends on the value of the **Model parameterization** parameter at the time the model entered Restricted mode.

Global Parameters

Parameters determined by the type of working fluid:

- **Fluid density**
- **Fluid kinematic viscosity**

Use the Hydraulic Fluid block or the Custom Hydraulic Fluid block to specify the fluid properties.

Ports

The block has the following ports:

A

Hydraulic conserving port associated with the resistance inlet.

B

Hydraulic conserving port associated with the resistance outlet.

References

[1] *Flow of Fluids Through Valves, Fittings, and Pipe*, Crane Valves North America, Technical Paper No. 410M

[2] Idelchik, I.E., *Handbook of Hydraulic Resistance*, CRC Begell House, 1994

Extended Capabilities

C/C++ Code Generation

Generate C and C++ code using Simulink® Coder™.

See Also

Elbow | Local Resistance | Pipe Bend | Sudden Area Change | T-junction

Topics

“Upgrading Simscape Fluids Models Containing Hydraulics (Isothermal) Blocks”

Introduced in R2006b

Heat Exchanger (G)

Heat exchanger for systems with gas and controlled flows

Library: Simscape / Fluids / Fluid Network Interfaces / Heat Exchangers

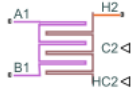

Description

The Heat Exchanger (G) block models heat exchange between a gas, which flows between ports **A1** and **B1**, and an external, *controlled* fluid via a physical signal. The physical signal ports **C2** and **HC2** are exposed when heat exchange is calculated according to the E-NTU model. The physical signal ports **CP2** and **M2** are exposed when heat exchange is calculated according to the Simple model.

You can set the E-NTU or Simple block variant by right-clicking on the block, selecting **Simscape > Block Choices**, and choosing your preferred heat exchange model.



The E-NTU Model

The default variant. Its heat transfer model derives from the Effectiveness-NTU method. Heat transfer in the steady state then proceeds at a fraction of the ideal rate which the flows, if kept each at its inlet temperature, and if cleared of every thermal resistance in between, could in theory support:

$$Q_{\text{Act}} = \epsilon Q_{\text{Max}}$$

where Q_{Act} the actual heat transfer rate, Q_{Max} is the ideal heat transfer rate, and ϵ is the fraction of the ideal rate actually observed in a real heat exchanger encumbered with losses. The fraction is the heat exchanger effectiveness, and it is a function of the number of transfer units, or NTU, a measure of the ease with which heat moves between flows, relative to the ease with which the flows absorb that heat:

$$NTU = \frac{1}{RC_{\text{Min}}},$$

where the fraction is the overall thermal conductance between the flows and C_{Min} is the smallest of the heat capacity rates from among the flows—that belonging to the flow least capable of absorbing

heat. The heat capacity rate of a flow depends on the specific heat of the fluid (c_p) and on its mass flow rate through the exchanger (\dot{m}):

$$C = c_p \dot{m}.$$

The effectiveness depends also on the relative disposition of the flows, the number of passes between them, and the mixing condition for each. This dependence reflects in the effectiveness expression used, with different flow arrangements corresponding to different expressions. For a list of the effectiveness expressions, see the E-NTU Heat Transfer block.

Flow Arrangement

Use the **Flow arrangement** block parameter to set how the flows meet in the heat exchanger. The flows can run parallel to each other, counter to each other, or across each other. They can also run in a pressurized shell, one through tubes enclosed in the shell, the other around those same tubes. The figure shows an example. The tube flow can make one pass through the shell flow (shown right) or, for greater exchanger effectiveness, multiple passes (left).

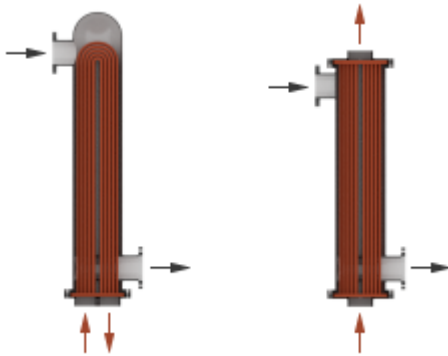

Other flow arrangements are possible through a generic parameterization based on tabulated effectiveness data and requiring little detail about the heat exchanger. Flow arrangement, mixing condition, and number of shell or tube passes, if relevant to the heat exchanger, are assumed to manifest in the tabulated data.

Mixing Condition

Use the **Cross flow type** parameter to mix each of the flows, one of the flows, or none of the flows. Mixing in this context is the lateral movement of fluid in channels that have no internal barriers, normally guides, baffles, fins, or walls. Such movement serves to even out temperature variations in the transverse plane. Mixed flows have variable temperature in the longitudinal plane alone. Unmixed flows have variable temperature in both the transverse and longitudinal planes. The figure shows a mixed flow (i) and an unmixed flow (ii).

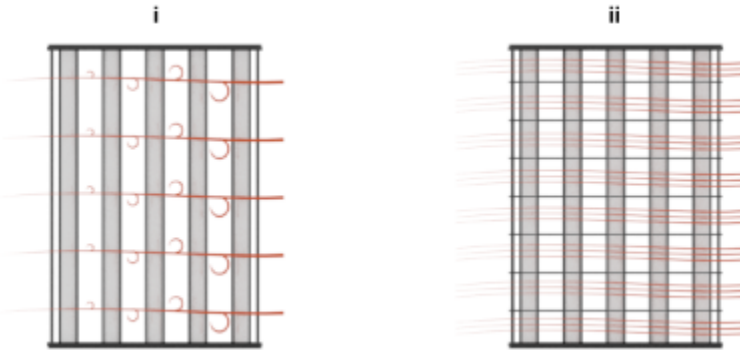

The distinction between mixed and unmixed flows is considered only in cross flow arrangements. There, longitudinal temperature variation in one fluid produces transverse temperature variation in the second fluid that mixing can even out. In counter and parallel flow arrangements, longitudinal temperature variation in one fluid produces longitudinal temperature variation in the second fluid and mixing, as it is of little effect here, is ignored.

Effectiveness Curves

Shell-and-tube exchangers with multiple passes (**iv.b-e** in the figure for 2, 3, and 4 passes) are most effective. Of exchangers with a single pass, those with counter flows (**ii**) are most effective and those with parallel flows (**i**) are least.

Cross-flow exchangers are intermediate in effectiveness, with mixing condition playing a factor. They are most effective when both flows are unmixed (**iii.a**) and least effective when both flows are mixed (**iii.b**). Mixing just the flow with the smallest heat capacity rate (**iii.c**) lowers the effectiveness more than mixing just the flow with the largest heat capacity rate (**iii.d**).

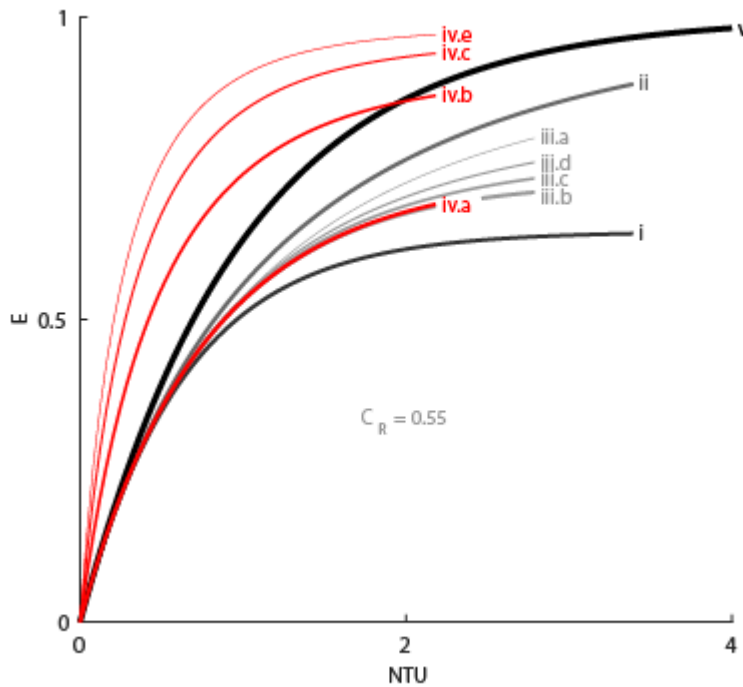

Thermal Resistance

The overall thermal resistance, R , is the sum of the local resistances lining the heat transfer path. The local resistances arise from convection at the surfaces of the wall, conduction through the wall, and, if the wall sides are fouled, conduction through the layers of fouling. Expressed in order from the gas side (subscript 1) to the controlled fluid side (subscript 2):

$$R = \frac{1}{U_1 A_{Th,1}} + \frac{F_1}{A_{Th,1}} + R_{Wall} + \frac{F_2}{A_{Th,2}} + \frac{1}{U_2 A_{Th,2}}$$

where U is the convective heat transfer coefficient, F is the fouling factor, and A_{Th} is the heat transfer surface area, each for the flow indicated in the subscript. R_W is the thermal resistance of the wall.

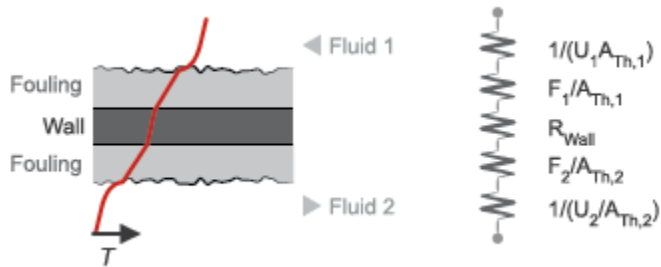

The wall thermal resistance and fouling factors are simple constants obtained from block parameters. The heat transfer coefficients are elaborate functions of fluid properties, flow geometry, and wall friction, and derive from standard empirical correlations between Reynolds, Nusselt, and Prandtl

numbers. The correlations depend on flow arrangement and mixing condition, and are detailed for each in the E-NTU Heat Transfer block on which the E-NTU Model variant is based.

Composite Structure

The E-NTU Model variant is a composite component built from simpler blocks. A Heat Exchanger Interface (G) block models the gas flow. Physical signals for the heat capacity rate and heat transfer coefficient, along with a thermal port for temperature, capture the controlled flow. An E-NTU Heat Transfer block models the heat exchanged across the wall between the flows. The figure shows the block connections for the E-NTU Model block variant.

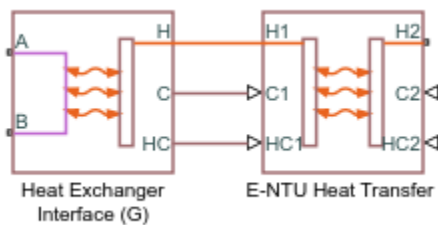

The Simple Model

The alternative variant. Its heat transfer model depends on the concept of *specific dissipation*, a measure of the heat transfer rate observed when gas and controlled fluid inlet temperatures differ by one degree. Its product with the inlet temperature difference gives the expected heat transfer rate:

$$Q = \xi(T_{In,1} - T_{In,2}),$$

where ξ is specific dissipation and T_{In} is inlet temperature for gas (subscript 1) or controlled fluid (subscript 2). The specific dissipation is a tabulated function of the mass flow rates into the exchanger through the gas and controlled fluid inlets:

$$\xi = f(\dot{m}_1, \dot{m}_2)$$

To accommodate reverse flows, the tabulated data can extend over positive and negative flow rates, in which case the inlets can also be thought of as outlets. The data normally derives from measurement of heat transfer rate against temperature in a real prototype:

$$\xi = \frac{Q}{T_{In,1} - T_{In,2}}$$

The heat transfer model, as it relies almost entirely on tabulated data, and as that data normally derives from experiment, requires little detail about the exchanger. Flow arrangement, mixing condition, and number of shell or tube passes, if relevant to the heat exchanger modeled, are assumed to manifest entirely in the tabulated data.

Composite Structure

The Simple Model variant is a composite component. A Simple Heat Exchanger Interface (G) block models the gas flow. Physical signals for the heat transfer coefficient and mass flow rate, along with a thermal port for temperature, capture the controlled flow. A Specific Dissipation Heat Transfer block models the heat exchanged across the wall between the flows.

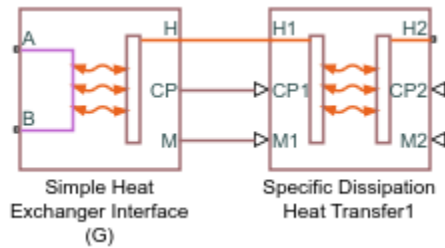

Ports

Conserving

A1 — Gas port

gas

Opening for gas to enter and exit its side of the heat exchanger.

B1 — Gas port

gas

Opening for gas to enter and exit its side of the heat exchanger.

Input

C2 — Heat capacity rate

physical signal

Instantaneous value of the heat capacity rate for the controlled flow.

Dependencies

This port is active only for the block variant of E-NTU Model.

HC2 — Heat transfer coefficient

physical signal

Instantaneous value of the heat transfer coefficient between the controlled flow and the wall.

Dependencies

This port is active only for the block variant of E-NTU Model.

CP2 — Isobaric specific heat of controlled fluid

physical signal

Instantaneous value of the isobaric specific heat for the controlled fluid.

Dependencies

This port is active only for the block variant of Simple Model.

M2 — Mass flow rate of controlled fluid

physical signal

Instantaneous value of the mass flow rate of the controlled fluid.

Dependencies

This port is active only for the block variant of Simple Model.

Parameters

Block Variant: Simple Model

Heat Transfer Tab

Gas mass flow rate vector — Mass flow rate of gas at each breakpoint in lookup table for specific heat dissipation table

numerical array with units of mass over time

Mass flow rate of gas at each breakpoint in the lookup table for the specific heat dissipation table. The block inter- and extrapolates the breakpoints to obtain the specific heat dissipation of the heat exchanger at any mass flow rate. Interpolation is the MATLAB `linear` type and extrapolation is nearest.

The mass flow rates can be positive, zero, or negative, but they must increase monotonically from left to right. Their number must equal the number of columns in the **Specific heat dissipation table** parameter. If the table has m rows and n columns, the mass flow rate vector must be n elements long.

Controlled fluid mass flow rate vector — Mass flow rate of controlled fluid at each breakpoint in lookup table for specific heat dissipation table

numerical array with units of mass over time

Mass flow rate of controlled fluid at each breakpoint in the lookup table for the specific heat dissipation table. The block inter- and extrapolates the breakpoints to obtain the specific heat dissipation of the heat exchanger at any mass flow rate. Interpolation is the MATLAB `linear` type and extrapolation is nearest.

The mass flow rates can be positive, zero, or negative, but they must increase monotonically from left to right. Their number must equal the number of columns in the **Specific heat dissipation table** parameter. If the table has m rows and n columns, the mass flow rate vector must be n elements long.

Specific heat dissipation table — Specific heat dissipation at each breakpoint in lookup table over mass flow rates of gas and controlled fluid

numerical array with units of power over temperature

Specific heat dissipation at each breakpoint in its lookup table over the mass flow rates of gas and controlled fluid. The block inter- and extrapolates the breakpoints to obtain the effectiveness at any pair of gas and controlled fluid mass flow rates. Interpolation is the MATLAB `linear` type and extrapolation is nearest.

The specific heat dissipation values must not be negative. They must align from top to bottom in order of increasing mass flow rate in the gas channel, and from left to right in order of increasing mass flow rate in the controlled fluid channel. The number of rows must equal the size of the **Gas mass flow rate vector** parameter, and the number of columns must equal the size of the **Controlled fluid mass flow rate vector** parameter.

Check if violating maximum specific dissipation — Warning condition for specific heat dissipation in excess of minimum heat capacity rate

Warning (default) | None

Warning condition for specific heat dissipation in excess of minimum heat capacity rate. Heat capacity rate is the product of mass flow rate and specific heat, and its minimum value is the lowest between the flows. This minimum gives the specific dissipation for a heat exchanger with maximum effectiveness and cannot be exceeded. See the Specific Dissipation Heat Transfer block for more detail.

Pressure Loss Tab

Mass flow rate vector — Mass flow rate at each breakpoint in lookup table for pressure drop

numerical array with units of mass per unit time

Mass flow rate at each breakpoint in the lookup table for the pressure drop. The block inter- and extrapolates the breakpoints to obtain the pressure drop at any mass flow rate. Interpolation is the MATLAB `linear` type and extrapolation is `nearest`.

The mass flow rates can be positive, zero, or negative and they can span across laminar, transient, and turbulent zones. They must, however, increase monotonically from left to right. Their number must equal the size of the **Pressure drop vector** parameter, with which they are to combine to complete the tabulated breakpoints.

Pressure drop vector — Pressure drop at each breakpoint in lookup table over mass flow rate

numerical array with units of pressure

Pressure drop at each breakpoint in its lookup table over the mass flow rate. The block inter- and extrapolates the breakpoints to obtain the pressure drop at any mass flow rate. Interpolation is the MATLAB `linear` type and extrapolation is `nearest`.

The pressure drops can be positive, zero, or negative, and they can span across laminar, transient, and turbulent zones. They must, however, increase monotonically from left to right. Their number must equal the size of the **Mass flow rate vector** parameter, with which they are to combine to complete the tabulated breakpoints.

Reference inflow temperature — Absolute inlet temperature assumed in tabulated data

293.15 K (default) | scalar with units of temperature

Absolute temperature established at the inlet in the gathering of the tabulated pressure drops. The reference inflow temperature and pressure determine the fluid density assumed in the tabulated data. During simulation, the ratio of reference to actual fluid densities multiplies the tabulated pressure drop to obtain the actual pressure drop.

Reference inflow pressure — Absolute inlet pressure assumed in tabulated data

0.101325 MPa (default) | scalar with units of pressure

Absolute pressure established at the inlet in the gathering of the tabulated pressure drops. The reference inflow temperature and pressure determine the fluid density assumed in the tabulated data. During simulation, the ratio of reference to actual fluid densities multiplies the tabulated pressure drop to obtain the actual pressure drop.

Mass flow rate threshold for flow reversal — Upper bound of numerically smooth region for mass flow rate

1e-3 kg/s (default) | scalar with units of mass/time

Mass flow rate below which its value is numerically smoothed to avoid discontinuities known to produce simulation errors at zero flow. See the Simple Heat Exchanger Interface (G) block (on which the Simple Model variant is based) for detail on the calculations for the gas side of the exchanger.

Gas volume — Volume of fluid in the gas flow channel

0.01 m³ (default) | scalar with units of length cubed

Volume of fluid in the gas flow channel.

Cross-sectional area at ports A1 and B1 — Flow area at the inlet and outlet of the flow channel

0.01 m² (default) | scalar with units of length squared

Flow area at the inlet and outlet of the gas flow channel. The ports are of the same size.

Block Variant: E-NTU Model

Common Tab

Flow arrangement — Manner in which the flows align in the heat exchanger

Parallel or counter flow (default) | Shell and tube | Cross flow | Generic - effectiveness table

Manner in which the flows align in the heat exchanger. The flows can run parallel to each other, counter to each other, or across each other. They can also run in a pressurized shell, one through tubes enclosed in the shell, the other around those tubes. Other flow arrangements are possible through a generic parameterization based on tabulated effectiveness data and requiring little detail about the heat exchanger.

Number of shell passes — Number of times the flow traverses the shell before exiting

1 (default) | unitless scalar

Number of times the flow traverses the shell before exiting.

Dependencies

This parameter applies solely to the **Flow arrangement** setting of Shell and tube.

Cross flow type — Mixing condition in each of the flow channels

Both fluids mixed (default) | Both fluids unmixed | Gas mixed & Controlled Fluid unmixed | Gas unmixed & Controlled Fluid mixed

Mixing condition in each of the flow channels. Mixing in this context is the lateral movement of fluid as it proceeds along its flow channel toward the outlet. The flows remain separate from each other. Unmixed flows are common in channels with plates, baffles, or fins. This setting reflects in the effectiveness of the heat exchanger, with unmixed flows being most effective and mixed flows being least.

Dependencies

This parameter applies solely to the **Flow arrangement** setting of Shell and tube.

Number of heat transfer units vector, NTU — Number of transfer units at each breakpoint in lookup table for heat exchanger effectiveness

unitless numerical array

Number of transfer units at each breakpoint in the lookup table for the heat exchanger effectiveness number. The table is two-way, with both the number of transfer units and the thermal capacity ratio serving as independent coordinates. The block inter- and extrapolates the breakpoints to obtain the effectiveness at any number of transfer units. Interpolation is the MATLAB `linear` type and extrapolation is `nearest`.

The numbers specified must be greater than zero and increase monotonically from left to right. The size of the vector must equal the number of rows in the **Effectiveness table** parameter. If the table has m rows and n columns, the vector for the number of transfer units must be m elements long.

Dependencies

This parameter applies solely to the **Flow arrangement** setting of `Generic - effectiveness table`.

Thermal capacity ratio vector, CR — Thermal capacity ratio at each breakpoint in lookup table for heat exchanger effectiveness

unitless numerical array

Thermal capacity ratio at each breakpoint in lookup table for heat exchanger effectiveness. The table is two-way, with both the number of transfer units and the heat capacity rate ratio serving as independent coordinates. The block inter- and extrapolates the breakpoints to obtain the effectiveness at any thermal capacity ratio. Interpolation is the MATLAB `linear` type and extrapolation is `nearest`.

The thermal capacity ratios must be greater than zero and increase monotonically from left to right. The size of the vector must equal the number of columns in the **Nusselt number table** parameter. If the table has m rows and n columns, the vector for the thermal capacity ratio must be n elements long. The thermal capacity ratio is the fraction of minimum over maximum heat capacity rates.

Dependencies

This parameter applies solely to the **Flow arrangement** setting of `Generic - effectiveness table`.

Effectiveness table, E(NTU, CR) — Heat exchanger effectiveness at each breakpoint in lookup table over the number of transfer units and thermal capacity ratio

unitless numerical array

Heat exchanger effectiveness at each breakpoint in its lookup table over the number of transfer units and thermal capacity ratio. The block inter- and extrapolates the breakpoints to obtain the effectiveness at any pair of number of transfer units and thermal capacity ratio. Interpolation is the MATLAB `linear` type and extrapolation is `nearest`.

The effectiveness values must be not be negative. They must align from top to bottom in order of increasing number of transfer units and from left to right in order of increasing thermal capacity ratio. The number of rows must equal the size of the **Number of heat transfer units vector** parameter, and the number of columns must equal the size of the **Thermal capacity ratio vector** parameter.

Dependencies

This parameter applies solely to the **Flow arrangement** setting of `Generic - effectiveness table`.

Wall thermal resistance — Resistance of the wall to heat flow by thermal conduction

1.6e-4 K/W (default) | scalar with units of temperature over power

Resistance of the wall to heat flow by thermal conduction, and the inverse of thermal conductance, or the product of thermal conductivity with the ratio of surface area to length. Wall resistance adds to convective and fouling resistances to determine the overall heat transfer coefficient between the flows.

Gas Tab**Minimum free-flow area — Cross-sectional area of the flow channel at its narrowest point**0.01 m² (default) | scalar with units of length squared

Cross-sectional area of the flow channel at its narrowest point. If the channel is a collection of ducts, tubes, slots, or grooves, the area is the sum of the areas in the collection—minus the occlusion due to walls, ridges, plates, or other barriers.

Gas volume — Total volume of fluid in the gas flow channel0.01 m³ (default) | scalar with units of length squared

Total volume of fluid contained in the gas flow channel.

Hydraulic diameter for pressure loss — Effective diameter of the flow channel at its narrowest point

0.1 m (default) | scalar with units of length

Effective inner diameter of the flow at its narrowest point. For channels not circular in cross section, that diameter is of an imaginary circle equal in area to the flow cross section. Its value is the ratio of the minimum free-flow area to a fourth of its gross perimeter.

If the channel is a collection of ducts, tubes, slots, or grooves, the gross perimeter is the sum of the perimeters in the collection. If the channel is a single pipe or tube and it is circular in cross section, the hydraulic diameter is the same as the true diameter.

Laminar flow upper Reynolds number limit — Start of transition between laminar and turbulent zones

2000 (default) | unitless scalar

Start of transition between laminar and turbulent zones. Above this number, inertial forces take hold and the flow grows progressively turbulent. The default value is characteristic of circular pipes and tubes with smooth surfaces.

Turbulent flow lower Reynolds number limit — End of transition between laminar and turbulent zones

4000 (default) | unitless scalar

End of transition between laminar and turbulent zones. Below this number, viscous forces take hold and the flow grows progressively laminar. The default value is characteristic of circular pipes and tubes with smooth surfaces.

Pressure loss parameterization — Mathematical model for pressure loss by viscous friction

constant loss coefficient (default) | correlations for tubes | Tabulated data - Darcy friction factor vs. Reynolds number | Tabulated data - Euler number vs. Reynolds number

Mathematical model for pressure loss by viscous friction. This setting determines which expressions to use for calculation and which block parameters to specify as input. See the Heat Exchanger Interface (G) block for the calculations by parameterization.

Pressure loss coefficient – Aggregate loss coefficient for all flow resistances between the ports

0.1 (default) | unitless scalar

Aggregate loss coefficient for all flow resistances in the flow channel—including the wall friction responsible for major loss and the local resistances, due to bends, elbows, and other geometry changes, responsible for minor loss.

The loss coefficient is an empirical dimensionless number commonly used to express the pressure loss due to viscous friction. It can be calculated from experimental data or, in some cases, obtained from product data sheets.

Dependencies

This parameter applies solely to the **Pressure loss parameterization** setting of Constant loss coefficient.

Length of flow path from inlet to outlet – Distance traveled from port to port

1 m (default) | unitless scalar with units of length

Total distance the flow must travel to reach across the ports. In multi-pass shell-and-tube exchangers, the total distance is the sum over all shell passes. In tube bundles, corrugated plates, and other channels in which the flow is split into parallel branches, it is the distance covered in a single branch. The longer the flow path, the steeper the major pressure loss due to viscous friction at the wall.

Dependencies

This parameter applies solely to the **Pressure loss parameterization** setting of Correlations for tubes and Tabulated data - Darcy friction factor vs Reynolds number.

Aggregate equivalent length of local resistances – Aggregate minor pressure loss expressed as a length

0.1 m (default) | scalar with units of length

Aggregate minor pressure loss expressed as a length. This length is that which all local resistances, such as elbows, tees, and unions, would add to the flow path if in their place was a simple wall extension. The larger the equivalent length, the steeper the minor pressure loss due to the local resistances.

Dependencies

This parameter applies solely to the **Pressure loss parameterization** setting of Correlations for tubes.

Internal surface absolute roughness – Mean height of surface protrusions behind wall friction

15e-6 m (default) | scalar with units of length

Mean height of the surface protrusions from which wall friction arises. Higher protrusions mean a rougher wall for more friction and so a steeper pressure loss. Surface roughness features in the Haaland correlation from which the Darcy friction factor derives and on which the pressure loss calculation depends.

Dependencies

This parameter applies solely to the **Pressure loss parameterization** setting of Correlations for tubes.

Laminar friction constant for Darcy friction factor – Pressure loss correction for flow cross section in laminar flow conditions

64 (default) | unitless scalar

Pressure loss correction for flow cross section in laminar flow conditions. This parameter is commonly referred to as the shape factor. Its ratio to the Reynolds number gives the Darcy friction factor for the pressure loss calculation in the laminar zone. The default value belongs to cylindrical pipes and tubes.

The shape factor derives for certain shapes from the solution of the Navier-Stokes equations. A square duct has a shape factor of 56, a rectangular duct with aspect ratio of 2:1 has a shape factor of 62, and an annular tube has a shape factor of 96, as does a slender conduit between parallel plates.

Dependencies

This parameter applies solely to the **Pressure loss parameterization** setting of Correlations for tubes.

Reynolds number vector for Darcy friction factor – Reynolds number at each breakpoint in lookup table for Darcy friction factor

unitless numerical array

Reynolds number at each breakpoint in the lookup table for the Darcy friction factor. The block interpolates and extrapolates the breakpoints to obtain the Darcy friction factor at any Reynolds number. Interpolation is the MATLAB `linear` type and extrapolation is `nearest`.

The Reynolds numbers must be greater than zero and increase monotonically from left to right. They can span across laminar, transient, and turbulent zones. Their number must equal the size of the **Darcy friction factor vector** parameter, with which they are to combine to complete the tabulated breakpoints.

Dependencies

This parameter applies solely to the **Pressure loss parameterization** setting of Tabulated data - Darcy friction factor vs. Reynolds number.

Darcy friction factor vector – Darcy friction factor at each breakpoint in lookup table over Reynolds number

unitless numerical array

Darcy friction factor at each breakpoint in its lookup table over the Reynolds number. The block interpolates and extrapolates the breakpoints to obtain the Darcy friction factor at any Reynolds number. Interpolation is the MATLAB `linear` type and extrapolation is `nearest`.

The Darcy friction factors must not be negative and they must align from left to right in order of increasing Reynolds number. Their number must equal the size of the **Reynolds number vector for Darcy friction factor** parameter, with which they are to combine to complete the tabulated breakpoints.

Dependencies

This parameter applies solely to the **Pressure loss parameterization** setting of Tabulated data - Darcy friction factor vs. Reynolds number.

Reynolds number vector for Euler number — Reynolds number at each breakpoint in lookup table for Euler number

unitless numerical array

Reynolds number at each breakpoint in the lookup table for the Euler number. The block inter- and extrapolates the breakpoints to obtain the Euler number at any Reynolds number. Interpolation is the MATLAB linear type and extrapolation is nearest.

The Reynolds numbers must be greater than zero and increase monotonically from left to right. They can span across laminar, transient, and turbulent zones. Their number must equal the size of the **Euler number vector** parameter, with which they are to combine to complete the tabulated breakpoints.

Dependencies

This parameter applies solely to the **Pressure loss parameterization** setting of Tabulated data - Euler number vs. Reynolds number.

Euler number vector — Euler number at each breakpoint in lookup table over Reynolds number

unitless numerical array

Euler number at each breakpoint in its lookup table over the Reynolds number. The block inter- and extrapolates the breakpoints to obtain the Euler number at any Reynolds number. Interpolation is the MATLAB linear type and extrapolation is nearest.

The Euler numbers must not be negative and they must align from left to right in order of increasing Reynolds number. Their number must equal the size of the **Reynolds number vector for Euler number** parameter, with which they are to combine to complete the tabulated breakpoints.

Dependencies

This parameter applies solely to the **Pressure loss parameterization** setting of Tabulated data - Euler number vs. Reynolds number.

Heat transfer parameterization — Mathematical model for heat transfer between fluid and wall

Constant heat transfer coefficient (default) | Correlations for tubes | Tabulated data - Colburn factor vs. Reynolds number | Tabulated data - Nusselt number vs. Reynolds number & Prandtl number

Mathematical model for heat transfer between fluid and wall. The choice of model determines which expressions to apply and which parameters to specify for heat transfer calculation. See the E-NTU Heat Transfer block for the calculations by parameterization.

Heat transfer surface area — Effective surface area used in heat transfer between fluid and wall

0.4 m² (default) | scalar with units of length squared

Effective surface area used in heat transfer between fluid and wall. The effective surface area is the sum of primary and secondary surface areas, or those of the wall, where it is exposed to fluid, and of the fins, if any are used. Fin surface area is normally scaled by a fin efficiency factor.

Gas-wall heat transfer coefficient – Heat transfer coefficient for convection between fluid and wall

0.4 m² (default) | unitless scalar

Heat transfer coefficient for convection between fluid and wall. Resistance due to fouling is captured separately in the **Fouling factor** parameter.

Dependencies

This parameter applies solely to the **Heat transfer parameterization** setting of Constant heat transfer coefficient.

Length of flow path for heat transfer – Characteristic length traversed in heat transfer between fluid and wall

1 m (default) | scalar with units of length

Characteristic length traversed in heat transfer between fluid and wall. This length factors in the calculation of the hydraulic diameter from which the heat transfer coefficient and the Reynolds number, as defined in the tabulated heat transfer parameterizations, derives.

Dependencies

This parameter applies solely to the **Heat transfer parameterization** setting of Tabulated data - Colburn factor vs. Reynolds number or Tabulated data - Nusselt number vs. Reynolds number & Prandtl number.

Nusselt number for laminar flow heat transfer – Constant assumed for Nusselt number in laminar flow

3.66 (default) | positive unitless scalar

Constant assumed for Nusselt number in laminar flow. The Nusselt number factors in the calculation of the heat transfer coefficient between fluid and wall, on which the heat transfer rate depends. The default value belongs to cylindrical pipes and tubes.

Dependencies

This parameter applies solely to the **Heat transfer parameterization** setting of Correlations for tubes.

Reynolds number vector for Colburn factor – Values of the Reynolds number at which to specify the Colburn factor data

unitless numerical array

Reynolds number at each breakpoint in the lookup table for the Colburn factor. The block interpolates the breakpoints to obtain the Colburn factor at any Reynolds number. Interpolation is the MATLAB linear type and extrapolation is nearest.

The Reynolds numbers must be greater than zero and increase monotonically from left to right. They can span across laminar, transient, and turbulent zones. Their number must equal the size of the **Colburn factor vector** parameter, with which they are to combine to complete the tabulated breakpoints.

Dependencies

This parameter applies solely to the **Heat transfer parameterization** setting of Tabulated data - Colburn factor vs. Reynolds number.

Colburn factor vector — Colburn factor at each breakpoint in lookup table over Reynolds number

unitless numerical array

Colburn factor at each breakpoint in its lookup table over the Reynolds number. The block inter- and extrapolates the breakpoints to obtain the Euler number at any Reynolds number. Interpolation is the MATLAB linear type and extrapolation is nearest.

The Colburn factors must not be negative and they must align from left to right in order of increasing Reynolds number. Their number must equal the size of the **Reynolds number vector for Colburn factor** parameter, with which they are to combine to complete the tabulated breakpoints.

Dependencies

This parameter applies solely to the **Heat transfer parameterization** setting of Tabulated data - Colburn factor vs. Reynolds number.

Reynolds number vector for Nusselt number — Reynolds number at each breakpoint in lookup table for Nusselt number

unitless numerical array

Reynolds number at each breakpoint in the lookup table for the Nusselt number. The table is two-way, with both Reynolds and Prandtl numbers serving as independent coordinates. The block inter- and extrapolates the breakpoints to obtain the Nusselt number at any Reynolds number. Interpolation is the MATLAB linear type and extrapolation is nearest.

The Reynolds numbers must be greater than zero and increase monotonically from left to right. They can span across laminar, transient, and turbulent zones. The size of the vector must equal the number of rows in the **Nusselt number table** parameter. If the table has m rows and n columns, the Reynolds number vector must be m elements long.

Dependencies

This parameter applies solely to the **Heat transfer parameterization** setting of Tabulated data - Nusselt number vs. Reynolds number & Prandtl number.

Prandtl number vector for Nusselt number — Prandtl number at each breakpoint in lookup table for Nusselt number

unitless numerical array

Prandtl number at each breakpoint in the lookup table for the Nusselt number. The table is two-way, with both Reynolds and Prandtl numbers serving as independent coordinates. The block inter- and extrapolates the breakpoints to obtain the Nusselt number at any Prandtl number. Interpolation is the MATLAB linear type and extrapolation is nearest.

The Prandtl numbers must be greater than zero and increase monotonically from left to right. They can span across laminar, transient, and turbulent zones. The size of the vector must equal the number of columns in the **Nusselt number table** parameter. If the table has m rows and n columns, the Prandtl number vector must be n elements long.

Dependencies

This parameter applies solely to the **Heat transfer parameterization** setting of Tabulated data - Nusselt number vs. Reynolds number & Prandtl number.

Nusselt number table, Nu (Re,Pr) — Nusselt number at each breakpoint in lookup table over Reynolds and Prandtl numbers

unitless numerical array

Nusselt number at each breakpoint in its lookup table over the Reynolds and Prandtl numbers. The block inter- and extrapolates the breakpoints to obtain the Nusselt number at any pair of Reynolds and Prandtl numbers. Interpolation is the MATLAB `linear` type and extrapolation is `nearest`. By determining the Nusselt number, the table feeds the calculation from which the heat transfer coefficient between fluid and wall derives.

The Nusselt numbers must be greater than zero. They must align from top to bottom in order of increasing Reynolds number and from left to right in order of increasing Prandtl numbers. The number of rows must equal the size of the **Reynolds number vector for Nusselt number** parameter, and the number of columns must equal the size of the **Prandtl number vector for Nusselt number** parameter.

Dependencies

This parameter applies solely to the **Heat transfer parameterization** setting of Tabulated data - Nusselt number vs. Reynolds number & Prandtl number.

Fouling factor — Measure of thermal resistance due to fouling deposits

$1.6e-4$ K/W (default) | scalar with units of temperature over power

Measure of thermal resistance due to fouling deposits which over time tend to build on the exposed surfaces of the wall. The deposits, as they impose between the fluid and wall a new solid layer through which heat must traverse, add to the heat transfer path an extra thermal resistance. Fouling deposits grow slowly and the resistance due to them is accordingly assumed constant during simulation.

Minimum fluid-wall heat transfer coefficient — Lower bound for the heat transfer coefficient

100 W/(m² * K) (default) | scalar with units of power/area/temperature

Lower bound for the heat transfer coefficient between fluid and wall. If calculation returns a lower heat transfer coefficient, this bound replaces the calculated value.

Controlled Fluid Tab**Heat transfer surface area — Aggregate heat transfer surface area on the controlled fluid side**

0.4 m² (default) | scalar with units of length squared

Aggregate heat transfer surface area on the controlled fluid side

Fouling factor — Measure of thermal resistance due to fouling deposits

$1e-4$ K/W (default) | scalar with units of length squared times temperature over power

Measure of thermal resistance due to fouling deposits which over time tend to build on the exposed surfaces of the wall. The deposits, as they impose between the controlled fluid and wall a new solid

layer through which heat must traverse, add to the heat transfer path an extra thermal resistance. Fouling deposits grow slowly and the resistance due to them is accordingly assumed constant during simulation.

Minimum fluid-wall heat transfer coefficient – Lower bound for the heat transfer coefficient

100 W/(m² * K) (default) | scalar with units of power/area/temperature

Lower bound for the heat transfer coefficient between the controlled fluid and wall. If calculation returns a lower heat transfer coefficient, this bound replaces the calculated value.

Effects and Initial Conditions**Gas initial temperature – Temperature in the gas channel at the start of simulation**

293.15 K (default) | scalar with units of temperature

Temperature in the gas channel at the start of simulation.

Gas initial pressure – Pressure in the gas channel at the start of simulation

0.101325 MPa (default) | scalar with units of pressure

Pressure in the gas channel at the start of simulation.

Extended Capabilities**C/C++ Code Generation**

Generate C and C++ code using Simulink® Coder™.

See Also

E-NTU Heat Transfer | Heat Exchanger Interface (G) | Specific Dissipation Heat Transfer | Simple Heat Exchanger Interface (G)

Introduced in R2017b

Heat Exchanger (G-G)

Heat exchanger for systems with two gas flows

Library: Simscape / Fluids / Fluid Network Interfaces / Heat Exchangers



Description

The Heat Exchanger (G-G) block models a gas-gas heat exchanger. The wall can store heat in its bounds, adding to the heat transfer a slight transient delay that scales in proportion to its thermal mass. The fluids are single phase—each a gas. Neither fluid can switch phase and so, as latent heat is never released, the exchange is strictly one of sensible heat.



Block Variants

The heat transfer model depends on the choice of block variant. The block has two variants: **E-NTU Model** and **Simple Model**. Right-click the block to open its context-sensitive menu and select **Simscape > Block Choices** to change variant.

E-NTU Model

The default variant. Its heat transfer model derives from the Effectiveness-NTU method. Heat transfer in the steady state then proceeds at a fraction of the ideal rate which the flows, if kept each at its inlet temperature, and if cleared of every thermal resistance in between, could in theory support:

$$Q_{\text{Act}} = \epsilon Q_{\text{Max}}$$

where Q_{Act} the actual heat transfer rate, Q_{Max} is the ideal heat transfer rate, and ϵ is the fraction of the ideal rate actually observed in a real heat exchanger encumbered with losses. The fraction is the heat exchanger effectiveness, and it is a function of the number of transfer units, or NTU, a measure of the ease with which heat moves between flows, relative to the ease with which the flows absorb that heat:

$$NTU = \frac{1}{RC_{\text{Min}}},$$

where the fraction is the overall thermal conductance between the flows and C_{Min} is the smallest of the heat capacity rates from among the flows—that belonging to the flow least capable of absorbing heat. The heat capacity rate of a flow depends on the specific heat of the fluid (c_p) and on its mass flow rate through the exchanger (\dot{m}):

$$C = c_p \dot{m}.$$

The effectiveness depends also on the relative disposition of the flows, the number of passes between them, and the mixing condition for each. This dependence reflects in the effectiveness expression used, with different flow arrangements corresponding to different expressions. For a list of the effectiveness expressions, see the E-NTU Heat Transfer block.

Flow Arrangement

Use the **Flow arrangement** block parameter to set how the flows meet in the heat exchanger. The flows can run parallel to each other, counter to each other, or across each other. They can also run in a pressurized shell, one through tubes enclosed in the shell, the other around those same tubes. The figure shows an example. The tube flow can make one pass through the shell flow (shown right) or, for greater exchanger effectiveness, multiple passes (left).

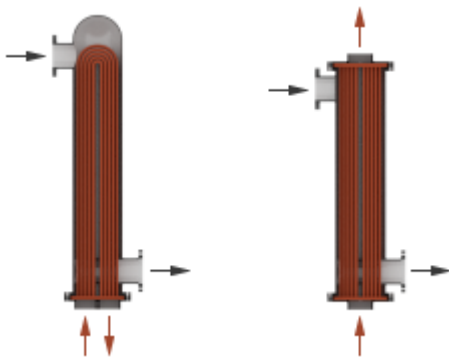

Other flow arrangements are possible through a generic parameterization based on tabulated effectiveness data and requiring little detail about the heat exchanger. Flow arrangement, mixing condition, and number of shell or tube passes, if relevant to the heat exchanger, are assumed to manifest in the tabulated data.

Mixing Condition

Use the **Cross flow type** parameter to mix each of the flows, one of the flows, or none of the flows. Mixing in this context is the lateral movement of fluid in channels that have no internal barriers, normally guides, baffles, fins, or walls. Such movement serves to even out temperature variations in the transverse plane. Mixed flows have variable temperature in the longitudinal plane alone. Unmixed flows have variable temperature in both the transverse and longitudinal planes. The figure shows a mixed flow (**i**) and an unmixed flow (**ii**).

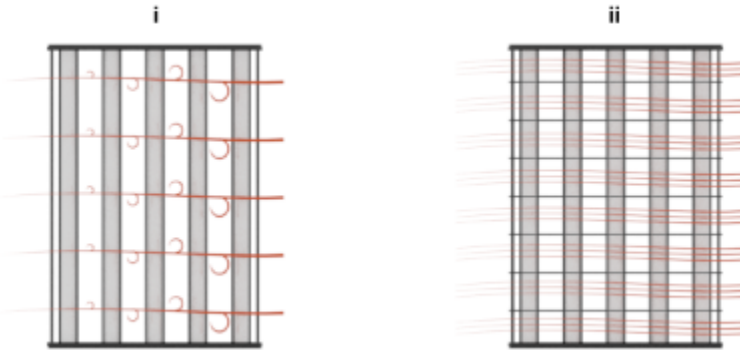

The distinction between mixed and unmixed flows is considered only in cross flow arrangements. There, longitudinal temperature variation in one fluid produces transverse temperature variation in the second fluid that mixing can even out. In counter and parallel flow arrangements, longitudinal temperature variation in one fluid produces longitudinal temperature variation in the second fluid and mixing, as it is of little effect here, is ignored.

Effectiveness Curves

Shell-and-tube exchangers with multiple passes (**iv.b-e** in the figure for 2, 3, and 4 passes) are most effective. Of exchangers with a single pass, those with counter flows (**ii**) are most effective and those with parallel flows (**i**) are least.

Cross-flow exchangers are intermediate in effectiveness, with mixing condition playing a factor. They are most effective when both flows are unmixed (**iii.a**) and least effective when both flows are mixed (**iii.b**). Mixing just the flow with the smallest heat capacity rate (**iii.c**) lowers the effectiveness more than mixing just the flow with the largest heat capacity rate (**iii.d**).

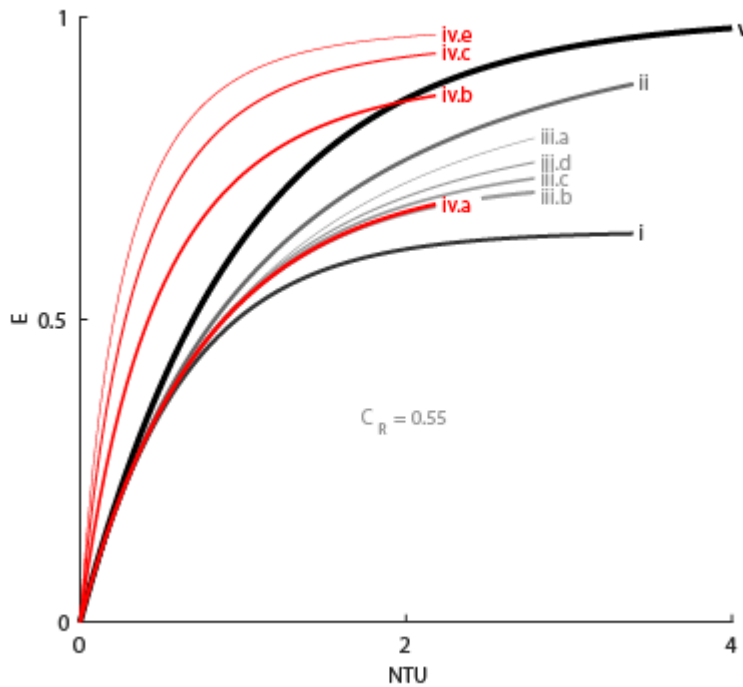

Thermal Resistance

The overall thermal resistance, R , is the sum of the local resistances lining the heat transfer path. The local resistances arise from convection at the surfaces of the wall, conduction through the wall, and, if the wall sides are fouled, conduction through the layers of fouling. Expressed in order from gas side 1 to gas side 2:

$$R = \frac{1}{U_1 A_{Th,1}} + \frac{F_1}{A_{Th,1}} + R_{W} + \frac{F_2}{A_{Th,2}} + \frac{1}{U_2 A_{Th,2}}$$

where U is the convective heat transfer coefficient, F is the fouling factor, and A_{Th} is the heat transfer surface area, each for the flow indicated in the subscript. R_W is the thermal resistance of the wall.

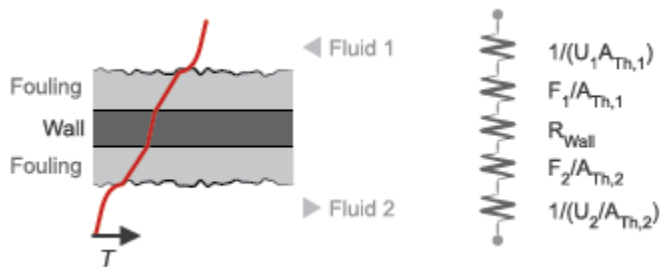

The wall thermal resistance and fouling factors are simple constants obtained from block parameters. The heat transfer coefficients are elaborate functions of fluid properties, flow geometry, and wall friction, and derive from standard empirical correlations between Reynolds, Nusselt, and Prandtl

numbers. The correlations depend on flow arrangement and mixing condition, and are detailed for each in the E-NTU Heat Transfer block on which the E-NTU Model variant is based.

Thermal Mass

The wall is more than a thermal resistance for heat to pass through. It is also a thermal mass and, like the flows it divides, it can store heat in its bounds. The storage slows the transition between steady states so that a thermal perturbation on one side does not promptly manifest on the side across. The lag persists for the short time that it takes the heat flow rates from the two sides to balance each other. That time interval scales with the thermal mass of the wall:

$$C_{Q,W} = c_{p,W}M_W,$$

where $c_{p,W}$ is the specific heat capacity and M_W the inertial mass of the wall. Their product gives the energy required to raise wall temperature by one degree. Use the **Wall thermal mass** block parameter to specify that product. The parameter is active when the **Wall thermal dynamics** setting is On.

Thermal mass is often negligible in low-pressure systems. Low pressure affords a thin wall with a transient response so fast that, on the time scale of the heat transfer, it is virtually instantaneous. The same is not true of high-pressure systems, common in the production of ammonia by the Haber process, where pressure can break 200 atmospheres. To withstand the high pressure, the wall is often thicker, and, as its thermal mass is heftier, so its transient response is slower.

Set the **Wall thermal dynamics** parameter to Off to ignore the transient lag, cut the differential variables that produce it, and, in reducing calculations, speed up the rate of simulation. Leave it On to capture the transient lag where it has a measurable effect. Experiment with the setting if necessary to determine whether to account for thermal mass. If simulation results differ to a considerable degree, and if simulation speed is not a factor, keep the setting On.

The wall, if modeled with thermal mass, is considered in halves. One half sits on gas side 1 and the other half sits on gas side 2. The thermal mass divides evenly between the pair:

$$C_{Q,1} = C_{Q,2} = \frac{C_{Q,W}}{2}.$$

Energy is conserved in the wall. In the simple case of a wall half at steady state, heat gained from the fluid equals heat lost to the second half. The heat flows at the rate predicted by the E-NTU method for a wall without thermal mass. The rate is positive for heat flows directed from side 1 of the heat exchanger to side 2:

$$Q_1 = -Q_2 = \epsilon Q_{\text{Max}}.$$

In the transient state, the wall is in the course of storing or losing heat, and heat gained by one half no longer equals that lost to the second half. The difference in the heat flow rates varies over time in proportion to the rate at which the wall stores or loses heat. For side 1 of the heat exchanger:

$$Q_1 = \epsilon Q_{\text{Max}} + C_{Q,1}\dot{T}_{W,1},$$

where $\dot{T}_{W,1}$ is the rate of change in temperature in the wall half. Its product with the thermal mass of the wall half gives the rate at which heat accumulates there. That rate is positive when temperature rises and negative when it drops. The closer the rate is to zero the closer the wall is to steady state.

For side 2 of the heat exchanger: $Q_2 = -\epsilon Q_{\text{Max}} + C_{Q,2}\dot{T}_{W,2}$,

Composite Structure

The E-NTU Model variant is a composite component built from simpler blocks. A Heat Exchanger Interface (G) block models the gas flow on side 1 of the heat exchanger. Another models the gas flow on side 2. An E-NTU Heat Transfer block models the heat exchanged across the wall between the flows. The figure shows the block connections for the E-NTU Model block variant.

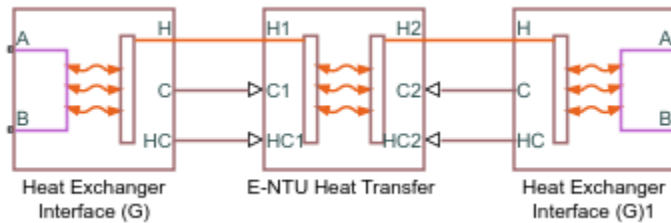

Simple Model

The alternative variant. Its heat transfer model depends on the concept of *specific dissipation*, a measure of the heat transfer rate observed when gas 1 and gas 2 inlet temperatures differ by one degree. Its product with the inlet temperature difference gives the expected heat transfer rate:

$$Q = \xi(T_{In,1} - T_{In,2}),$$

where ξ is specific dissipation and T_{In} is inlet temperature for gas 1 (subscript 1) or gas 2 (subscript 2). The specific dissipation is a tabulated function of the mass flow rates into the exchanger through the gas 1 and gas 2 inlets:

$$\xi = f(\dot{m}_1, \dot{m}_2)$$

To accommodate reverse flows, the tabulated data can extend over positive and negative flow rates, in which case the inlets can also be thought of as outlets. The data normally derives from measurement of heat transfer rate against temperature in a real prototype:

$$\xi = \frac{Q}{T_{In,1} - T_{In,2}}$$

The heat transfer model, as it relies almost entirely on tabulated data, and as that data normally derives from experiment, requires little detail about the exchanger. Flow arrangement, mixing condition, and number of shell or tube passes, if relevant to the heat exchanger modeled, are assumed to manifest entirely in the tabulated data.

See the Specific Dissipation Heat Transfer block for more detail on the heat transfer calculations.

Composite Structure

The Simple Model variant is a composite component. A Simple Heat Exchanger Interface (G) block models the gas flow on side 1 of the heat exchanger. Another models the gas flow on side 2. A Specific Dissipation Heat Transfer block captures the heat exchanged across the wall between the flows.

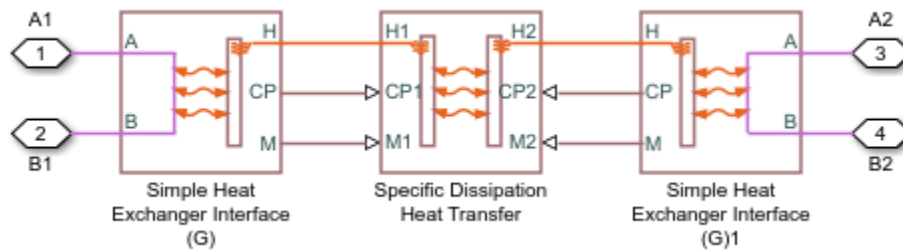

Ports

Conserving

A1 — Gas 1 port

gas

Opening for gas 1 to enter and exit its side of the heat exchanger.

B1 — Gas 1 port

gas

Opening for gas 1 to enter and exit its side of the heat exchanger.

A2 — Gas 2 port

gas

Opening for gas 2 to enter and exit its side of the heat exchanger.

B2 — Gas 2 port

gas

Opening for gas 2 to enter and exit its side of the heat exchanger.

Parameters

Block Variant: Simple Model

Heat Transfer Tab

Gas 1 mass flow rate vector — Mass flow rate of gas 1 at each breakpoint in lookup table for specific heat dissipation table

numerical array with units of mass over time

Mass flow rate of gas 1 at each breakpoint in the lookup table for the specific heat dissipation table. The block inter- and extrapolates the breakpoints to obtain the specific heat dissipation of the heat exchanger at any mass flow rate. Interpolation is the MATLAB `linear` type and extrapolation is `nearest`.

The mass flow rates can be positive, zero, or negative, but they must increase monotonically from left to right. Their number must equal the number of columns in the **Specific heat dissipation table** parameter. If the table has m rows and n columns, the mass flow rate vector must be n elements long.

Gas 2 mass flow rate vector — Mass flow rate of gas 2 at each breakpoint in lookup table for specific heat dissipation table

numerical array with units of mass over time

Mass flow rate of gas 2 at each breakpoint in the lookup table for the specific heat dissipation table. The block inter- and extrapolates the breakpoints to obtain the specific heat dissipation of the heat exchanger at any mass flow rate. Interpolation is the MATLAB `linear` type and extrapolation is `nearest`.

The mass flow rates can be positive, zero, or negative, but they must increase monotonically from left to right. Their number must equal the number of columns in the **Specific heat dissipation table** parameter. If the table has m rows and n columns, the mass flow rate vector must be n elements long.

Specific heat dissipation table — Specific heat dissipation at each breakpoint in lookup table over mass flow rates of gas 1 and gas 2

numerical array with units of power over temperature

Specific heat dissipation at each breakpoint in its lookup table over the mass flow rates of gas 1 and gas 2. The block inter- and extrapolates the breakpoints to obtain the effectiveness at any pair of gas 1 and gas 2 mass flow rates. Interpolation is the MATLAB `linear` type and extrapolation is `nearest`.

The specific heat dissipation values must be not be negative. They must align from top to bottom in order of increasing mass flow rate in the gas 1 channel, and from left to right in order of increasing mass flow rate in the gas 2 channel. The number of rows must equal the size of the **Gas 1 mass flow rate vector** parameter, and the number of columns must equal the size of the **Gas 2 mass flow rate vector** parameter.

Check if violating maximum specific dissipation — Warning condition for specific heat dissipation in excess of minimum heat capacity rate

Warning (default) | None

Warning condition for specific heat dissipation in excess of minimum heat capacity rate. Heat capacity rate is the product of mass flow rate and specific heat, and its minimum value is the lowest between the flows. This minimum gives the specific dissipation for a heat exchanger with maximum effectiveness and cannot be exceeded. See the Specific Dissipation Heat Transfer block for more detail.

Gas 1|2 Tab**Mass flow rate vector — Mass flow rate at each breakpoint in lookup table for pressure drop**

numerical array with units of mass per unit time

Mass flow rate at each breakpoint in the lookup table for the pressure drop. The block inter- and extrapolates the breakpoints to obtain the pressure drop at any mass flow rate. Interpolation is the MATLAB `linear` type and extrapolation is `nearest`.

The mass flow rates can be positive, zero, or negative and they can span across laminar, transient, and turbulent zones. They must, however, increase monotonically from left to right. Their number must equal the size of the **Pressure drop vector** parameter, with which they are to combine to complete the tabulated breakpoints.

Pressure drop vector — Pressure drop at each breakpoint in lookup table over mass flow rate

numerical array with units of pressure

Pressure drop at each breakpoint in its lookup table over the mass flow rate. The block interpolates and extrapolates the breakpoints to obtain the pressure drop at any mass flow rate. Interpolation is the MATLAB linear type and extrapolation is nearest.

The pressure drops can be positive, zero, or negative, and they can span across laminar, transient, and turbulent zones. They must, however, increase monotonically from left to right. Their number must equal the size of the **Mass flow rate vector** parameter, with which they are to combine to complete the tabulated breakpoints.

Reference inflow temperature — Absolute inlet temperature assumed in tabulated data

293.15 K (default) | scalar with units of temperature

Absolute temperature established at the inlet in the gathering of the tabulated pressure drops. The reference inflow temperature and pressure determine the fluid density assumed in the tabulated data. During simulation, the ratio of reference to actual fluid densities multiplies the tabulated pressure drop to obtain the actual pressure drop.

Reference inflow pressure — Absolute inlet pressure assumed in tabulated data

0.101325 MPa (default) | scalar with units of pressure

Absolute pressure established at the inlet in the gathering of the tabulated pressure drops. The reference inflow temperature and pressure determine the fluid density assumed in the tabulated data. During simulation, the ratio of reference to actual fluid densities multiplies the tabulated pressure drop to obtain the actual pressure drop.

Threshold mass flow rate for flow reversal — Upper bound of numerically smooth region for mass flow rate

1e-3 kg/s (default) | scalar with units of mass/time

Mass flow rate below which its value is numerically smoothed to avoid discontinuities known to produce simulation errors at zero flow. See the Simple Heat Exchanger Interface (G) block (on which the Simple Model variant is based) for detail on the calculations.

Fluid volume — Volume of fluid in the gas 1 or gas 2 flow channel

0.01 m³ (default) | scalar with units of length cubed

Volume of fluid in the gas 1 or gas 2 flow channel.

Cross-sectional area at ports A and B — Flow area at the inlet and outlet of the flow channel

0.01 m² (default) | scalar with units of length squared

Flow area at the inlet and outlet of the gas 1 or gas 2 flow channel. Ports in the same flow channel are of the same size.

Block Variant: E-NTU Model

Common Tab

Flow arrangement — Manner in which the flows align in the heat exchanger

Parallel or counter flow (default) | Shell and tube | Cross flow | Generic - effectiveness table

Manner in which the flows align in the heat exchanger. The flows can run parallel to each other, counter to each other, or across each other. They can also run in a pressurized shell, one through

tubes enclosed in the shell, the other around those tubes. Other flow arrangements are possible through a generic parameterization based on tabulated effectiveness data and requiring little detail about the heat exchanger.

Number of shell passes — Number of times the flow traverses the shell before exiting

1 (default) | unitless scalar

Number of times the flow traverses the shell before exiting.

Dependencies

This parameter applies solely to the **Flow arrangement** setting of Shell and tube.

Cross flow type — Mixing condition in each of the flow channels

Both fluids mixed (default) | Both fluids unmixed | Gas 1 mixed & Gas 2 unmixed | Gas 1 unmixed & Gas 2 mixed

Mixing condition in each of the flow channels. Mixing in this context is the lateral movement of fluid as it proceeds along its flow channel toward the outlet. The flows remain separate from each other. Unmixed flows are common in channels with plates, baffles, or fins. This setting reflects in the effectiveness of the heat exchanger, with unmixed flows being most effective and mixed flows being least.

Dependencies

This parameter applies solely to the **Flow arrangement** setting of Shell and tube.

Number of heat transfer units vector, NTU — Number of transfer units at each breakpoint in lookup table for heat exchanger effectiveness

unitless numerical array

Number of transfer units at each breakpoint in the lookup table for the heat exchanger effectiveness number. The table is two-way, with both the number of transfer units and the thermal capacity ratio serving as independent coordinates. The block inter- and extrapolates the breakpoints to obtain the effectiveness at any number of transfer units. Interpolation is the MATLAB `linear` type and extrapolation is `nearest`.

The numbers specified must be greater than zero and increase monotonically from left to right. The size of the vector must equal the number of rows in the **Effectiveness table** parameter. If the table has m rows and n columns, the vector for the number of transfer units must be m elements long.

Dependencies

This parameter applies solely to the **Flow arrangement** setting of Generic - effectiveness table.

Thermal capacity ratio vector, CR — Thermal capacity ratio at each breakpoint in lookup table for heat exchanger effectiveness

unitless numerical array

Thermal capacity ratio at each breakpoint in lookup table for heat exchanger effectiveness. The table is two-way, with both the number of transfer units and the heat capacity rate ratio serving as independent coordinates. The block inter- and extrapolates the breakpoints to obtain the effectiveness at any thermal capacity ratio. Interpolation is the MATLAB `linear` type and extrapolation is `nearest`.

The thermal capacity ratios must be greater than zero and increase monotonically from left to right. The size of the vector must equal the number of columns in the **Nusselt number table** parameter. If the table has m rows and n columns, the vector for the thermal capacity ratio must be n elements long. The thermal capacity ratio is the fraction of minimum over maximum heat capacity rates.

Dependencies

This parameter applies solely to the **Flow arrangement** setting of Generic - effectiveness table.

Effectiveness table, E(NTU,CR) — Heat exchanger effectiveness at each breakpoint in lookup table over the number of transfer units and thermal capacity ratio

unitless numerical array

Heat exchanger effectiveness at each breakpoint in its lookup table over the number of transfer units and thermal capacity ratio. The block inter- and extrapolates the breakpoints to obtain the effectiveness at any pair of number of transfer units and thermal capacity ratio. Interpolation is the MATLAB linear type and extrapolation is nearest.

The effectiveness values must not be negative. They must align from top to bottom in order of increasing number of transfer units and from left to right in order of increasing thermal capacity ratio. The number of rows must equal the size of the **Number of heat transfer units vector** parameter, and the number of columns must equal the size of the **Thermal capacity ratio vector** parameter.

Dependencies

This parameter applies solely to the **Flow arrangement** setting of Generic - effectiveness table.

Wall thermal dynamics — Modeling assumption for transient response of wall to thermal changes

Off (default) | On

Modeling assumption for the transient response of the wall to thermal changes. Set to On to impart a thermal mass to the wall and to capture the delay in its transient response to changes in temperature or heat flux. Such delays are relevant in thick walls, such as those required to sustain high pressures. The default setting assumes a wall thin enough for its transient response to be virtually instantaneous on the time scale of the heat transfer.

Wall thermal mass — Heat required to raise wall temperature by one degree

447 J/K (default) | scalar with units of energy over temperature

Heat required to raise wall temperature by one degree. Thermal mass is the product of mass with specific heat and a measure of the ability to absorb heat. A wall with thermal mass has a transient response to sudden changes in surface temperature or heat flux. The larger the thermal mass, the slower that response, and the longer the time to steady state. The default value corresponds to a wall of stainless steel with a mass of approximately 1 kg.

Dependencies

This parameter applies solely to the **Wall thermal dynamics** setting of On.

Wall thermal resistance — Resistance of the wall to heat flow by thermal conduction

1.6e-4 K/W (default) | scalar with units of temperature over power

Resistance of the wall to heat flow by thermal conduction, and the inverse of thermal conductance, or the product of thermal conductivity with the ratio of surface area to length. Wall resistance adds to convective and fouling resistances to determine the overall heat transfer coefficient between the flows.

Gas 1|2 Tab

Minimum free-flow area — Cross-sectional area of the flow channel at its narrowest point

0.01 m² (default) | scalar with units of length squared

Cross-sectional area of the flow channel at its narrowest point. If the channel is a collection of ducts, tubes, slots, or grooves, the area is the sum of the areas in the collection—minus the occlusion due to walls, ridges, plates, or other barriers.

Fluid volume — Total volume of fluid in the gas 1 or gas 2 flow channel

0.01 m³ (default) | scalar with units of length squared

Total volume of fluid contained in the gas 1 or gas 2 flow channel.

Hydraulic diameter for pressure loss — Effective diameter of the flow channel at its narrowest point

0.1 m (default) | scalar with units of length

Effective inner diameter of the flow at its narrowest point. For channels not circular in cross section, that diameter is of an imaginary circle equal in area to the flow cross section. Its value is the ratio of the minimum free-flow area to a fourth of its gross perimeter.

If the channel is a collection of ducts, tubes, slots, or grooves, the gross perimeter is the sum of the perimeters in the collection. If the channel is a single pipe or tube and it is circular in cross section, the hydraulic diameter is the same as the true diameter.

Laminar flow upper Reynolds number limit — Start of transition between laminar and turbulent zones

2000 (default) | unitless scalar

Start of transition between laminar and turbulent zones. Above this number, inertial forces take hold and the flow grows progressively turbulent. The default value is characteristic of circular pipes and tubes with smooth surfaces.

Turbulent flow lower Reynolds number limit — End of transition between laminar and turbulent zones

4000 (default) | unitless scalar

End of transition between laminar and turbulent zones. Below this number, viscous forces take hold and the flow grows progressively laminar. The default value is characteristic of circular pipes and tubes with smooth surfaces.

Pressure loss parameterization — Mathematical model for pressure loss by viscous friction

constant loss coefficient (default) | correlations for tubes | Tabulated data - Darcy friction factor vs. Reynolds number | Tabulated data - Euler number vs. Reynolds number

Mathematical model for pressure loss by viscous friction. This setting determines which expressions to use for calculation and which block parameters to specify as input. See the Heat Exchanger Interface (G) block for the calculations by parameterization.

Pressure loss coefficient – Aggregate loss coefficient for all flow resistances between the ports

0.1 (default) | unitless scalar

Aggregate loss coefficient for all flow resistances in the flow channel—including the wall friction responsible for major loss and the local resistances, due to bends, elbows, and other geometry changes, responsible for minor loss.

The loss coefficient is an empirical dimensionless number commonly used to express the pressure loss due to viscous friction. It can be calculated from experimental data or, in some cases, obtained from product data sheets.

Dependencies

This parameter applies solely to the **Pressure loss parameterization** setting of Constant loss coefficient.

Length of flow path from inlet to outlet – Distance traveled from port to port

1 m (default) | unitless scalar with units of length

Total distance the flow must travel to reach across the ports. In multi-pass shell-and-tube exchangers, the total distance is the sum over all shell passes. In tube bundles, corrugated plates, and other channels in which the flow is split into parallel branches, it is the distance covered in a single branch. The longer the flow path, the steeper the major pressure loss due to viscous friction at the wall.

Dependencies

This parameter applies solely to the **Pressure loss parameterization** setting of Correlations for tubes and Tabulated data - Darcy friction factor vs Reynolds number.

Aggregate equivalent length of local resistances – Aggregate minor pressure loss expressed as a length

0.1 m (default) | scalar with units of length

Aggregate minor pressure loss expressed as a length. This length is that which all local resistances, such as elbows, tees, and unions, would add to the flow path if in their place was a simple wall extension. The larger the equivalent length, the steeper the minor pressure loss due to the local resistances.

Dependencies

This parameter applies solely to the **Pressure loss parameterization** setting of Correlations for tubes.

Internal surface absolute roughness – Mean height of surface protrusions behind wall friction

15e-6 m (default) | scalar with units of length

Mean height of the surface protrusions from which wall friction arises. Higher protrusions mean a rougher wall for more friction and so a steeper pressure loss. Surface roughness features in the Haaland correlation from which the Darcy friction factor derives and on which the pressure loss calculation depends.

Dependencies

This parameter applies solely to the **Pressure loss parameterization** setting of Correlations for tubes.

Laminar friction constant for Darcy friction factor – Pressure loss correction for flow cross section in laminar flow conditions

64 (default) | unitless scalar

Pressure loss correction for flow cross section in laminar flow conditions. This parameter is commonly referred to as the shape factor. Its ratio to the Reynolds number gives the Darcy friction factor for the pressure loss calculation in the laminar zone. The default value belongs to cylindrical pipes and tubes.

The shape factor derives for certain shapes from the solution of the Navier-Stokes equations. A square duct has a shape factor of 56, a rectangular duct with aspect ratio of 2:1 has a shape factor of 62, and an annular tube has a shape factor of 96, as does a slender conduit between parallel plates.

Dependencies

This parameter applies solely to the **Pressure loss parameterization** setting of Correlations for tubes.

Reynolds number vector for Darcy friction factor – Reynolds number at each breakpoint in lookup table for Darcy friction factor

unitless numerical array

Reynolds number at each breakpoint in the lookup table for the Darcy friction factor. The block interpolates and extrapolates the breakpoints to obtain the Darcy friction factor at any Reynolds number. Interpolation is the MATLAB `linear` type and extrapolation is `nearest`.

The Reynolds numbers must be greater than zero and increase monotonically from left to right. They can span across laminar, transient, and turbulent zones. Their number must equal the size of the **Darcy friction factor vector** parameter, with which they are to combine to complete the tabulated breakpoints.

Dependencies

This parameter applies solely to the **Pressure loss parameterization** setting of Tabulated data - Darcy friction factor vs. Reynolds number.

Darcy friction factor vector – Darcy friction factor at each breakpoint in lookup table over Reynolds number

unitless numerical array

Darcy friction factor at each breakpoint in its lookup table over the Reynolds number. The block interpolates and extrapolates the breakpoints to obtain the Darcy friction factor at any Reynolds number. Interpolation is the MATLAB `linear` type and extrapolation is `nearest`.

The Darcy friction factors must not be negative and they must align from left to right in order of increasing Reynolds number. Their number must equal the size of the **Reynolds number vector for Darcy friction factor** parameter, with which they are to combine to complete the tabulated breakpoints.

Dependencies

This parameter applies solely to the **Pressure loss parameterization** setting of Tabulated data - Darcy friction factor vs. Reynolds number.

Reynolds number vector for Euler number – Reynolds number at each breakpoint in lookup table for Euler number

unitless numerical array

Reynolds number at each breakpoint in the lookup table for the Euler number. The block inter- and extrapolates the breakpoints to obtain the Euler number at any Reynolds number. Interpolation is the MATLAB linear type and extrapolation is nearest.

The Reynolds numbers must be greater than zero and increase monotonically from left to right. They can span across laminar, transient, and turbulent zones. Their number must equal the size of the **Euler number vector** parameter, with which they are to combine to complete the tabulated breakpoints.

Dependencies

This parameter applies solely to the **Pressure loss parameterization** setting of Tabulated data - Euler number vs. Reynolds number.

Euler number vector – Euler number at each breakpoint in lookup table over Reynolds number

unitless numerical array

Euler number at each breakpoint in its lookup table over the Reynolds number. The block inter- and extrapolates the breakpoints to obtain the Euler number at any Reynolds number. Interpolation is the MATLAB linear type and extrapolation is nearest.

The Euler numbers must not be negative and they must align from left to right in order of increasing Reynolds number. Their number must equal the size of the **Reynolds number vector for Euler number** parameter, with which they are to combine to complete the tabulated breakpoints.

Dependencies

This parameter applies solely to the **Pressure loss parameterization** setting of Tabulated data - Euler number vs. Reynolds number.

Heat transfer parameterization – Mathematical model for heat transfer between fluid and wall

Constant heat transfer coefficient (default) | Correlations for tubes | Tabulated data - Colburn factor vs. Reynolds number | Tabulated data - Nusselt number vs. Reynolds number & Prandtl number

Mathematical model for heat transfer between fluid and wall. The choice of model determines which expressions to apply and which parameters to specify for heat transfer calculation. See the E-NTU Heat Transfer block for the calculations by parameterization.

Heat transfer surface area – Effective surface area used in heat transfer between fluid and wall

0.4 m² (default) | scalar with units of length squared

Effective surface area used in heat transfer between fluid and wall. The effective surface area is the sum of primary and secondary surface areas, or those of the wall, where it is exposed to fluid, and of the fins, if any are used. Fin surface area is normally scaled by a fin efficiency factor.

Gas-wall heat transfer coefficient – Heat transfer coefficient for convection between fluid and wall

0.4 m² (default) | unitless scalar

Heat transfer coefficient for convection between fluid and wall. Resistance due to fouling is captured separately in the **Fouling factor** parameter.

Dependencies

This parameter applies solely to the **Heat transfer parameterization** setting of Constant heat transfer coefficient.

Length of flow path for heat transfer – Length of pipe or channel

1 m (default) | scalar with units of length

Length of the pipe or channel from inlet to outlet.

Dependencies

This parameter applies solely to the **Heat transfer parameterization** setting of Tabulated data - Colburn factor vs. Reynolds number or Tabulated data - Nusselt number vs. Reynolds number & Prandtl number.

Nusselt number for laminar flow heat transfer – Constant assumed for Nusselt number in laminar flow

3.66 (default) | positive unitless scalar

Constant assumed for Nusselt number in laminar flow. The Nusselt number factors in the calculation of the heat transfer coefficient between fluid and wall, on which the heat transfer rate depends. The default value belongs to cylindrical pipes and tubes.

Dependencies

This parameter applies solely to the **Heat transfer parameterization** setting of Correlations for tubes.

Reynolds number vector for Colburn factor – Values of the Reynolds number at which to specify the Colburn factor data

unitless numerical array

Reynolds number at each breakpoint in the lookup table for the Colburn factor. The block inter- and extrapolates the breakpoints to obtain the Colburn factor at any Reynolds number. Interpolation is the MATLAB linear type and extrapolation is nearest.

The Reynolds numbers must be greater than zero and increase monotonically from left to right. They can span across laminar, transient, and turbulent zones. Their number must equal the size of the **Colburn factor vector** parameter, with which they are to combine to complete the tabulated breakpoints.

Dependencies

This parameter applies solely to the **Heat transfer parameterization** setting of Tabulated data - Colburn factor vs. Reynolds number.

Colburn factor vector – Colburn factor at each breakpoint in lookup table over Reynolds number

unitless numerical array

Colburn factor at each breakpoint in its lookup table over the Reynolds number. The block inter- and extrapolates the breakpoints to obtain the Euler number at any Reynolds number. Interpolation is the MATLAB `linear` type and extrapolation is `nearest`.

The Colburn factors must not be negative and they must align from left to right in order of increasing Reynolds number. Their number must equal the size of the **Reynolds number vector for Colburn factor** parameter, with which they are to combine to complete the tabulated breakpoints.

Dependencies

This parameter applies solely to the **Heat transfer parameterization** setting of `Tabulated data - Colburn factor vs. Reynolds number`.

Reynolds number vector for Nusselt number – Reynolds number at each breakpoint in lookup table for Nusselt number

unitless numerical array

Reynolds number at each breakpoint in the lookup table for the Nusselt number. The table is two-way, with both Reynolds and Prandtl numbers serving as independent coordinates. The block inter- and extrapolates the breakpoints to obtain the Nusselt number at any Reynolds number. Interpolation is the MATLAB `linear` type and extrapolation is `nearest`.

The Reynolds numbers must be greater than zero and increase monotonically from left to right. They can span across laminar, transient, and turbulent zones. The size of the vector must equal the number of rows in the **Nusselt number table** parameter. If the table has m rows and n columns, the Reynolds number vector must be m elements long.

Dependencies

This parameter applies solely to the **Heat transfer parameterization** setting of `Tabulated data - Nusselt number vs. Reynolds number & Prandtl number`.

Prandtl number vector for Nusselt number – Prandtl number at each breakpoint in lookup table for Nusselt number

unitless numerical array

Prandtl number at each breakpoint in the lookup table for the Nusselt number. The table is two-way, with both Reynolds and Prandtl numbers serving as independent coordinates. The block inter- and extrapolates the breakpoints to obtain the Nusselt number at any Prandtl number. Interpolation is the MATLAB `linear` type and extrapolation is `nearest`.

The Prandtl numbers must be greater than zero and increase monotonically from left to right. They can span across laminar, transient, and turbulent zones. The size of the vector must equal the number of columns in the **Nusselt number table** parameter. If the table has m rows and n columns, the Prandtl number vector must be n elements long.

Dependencies

This parameter applies solely to the **Heat transfer parameterization** setting of `Tabulated data - Nusselt number vs. Reynolds number & Prandtl number`.

Nusselt number table, Nu (Re,Pr) — Nusselt number at each breakpoint in lookup table over Reynolds and Prandtl numbers

unitless numerical array

Nusselt number at each breakpoint in its lookup table over the Reynolds and Prandtl numbers. The block inter- and extrapolates the breakpoints to obtain the Nusselt number at any pair of Reynolds and Prandtl numbers. Interpolation is the MATLAB `linear` type and extrapolation is `nearest`. By determining the Nusselt number, the table feeds the calculation from which the heat transfer coefficient between fluid and wall derives.

The Nusselt numbers must be greater than zero. They must align from top to bottom in order of increasing Reynolds number and from left to right in order of increasing Prandtl numbers. The number of rows must equal the size of the **Reynolds number vector for Nusselt number** parameter, and the number of columns must equal the size of the **Prandtl number vector for Nusselt number** parameter.

Dependencies

This parameter applies solely to the **Heat transfer parameterization** setting of `Tabulated data - Nusselt number vs. Reynolds number & Prandtl number`.

Fouling factor — Measure of thermal resistance due to fouling deposits

1.6e-4 K/W (default) | scalar with units of temperature over power

Measure of thermal resistance due to fouling deposits which over time tend to build on the exposed surfaces of the wall. The deposits, as they impose between the fluid and wall a new solid layer through which heat must traverse, add to the heat transfer path an extra thermal resistance. Fouling deposits grow slowly and the resistance due to them is accordingly assumed constant during simulation.

Minimum fluid-wall heat transfer coefficient — Lower bound for the heat transfer coefficient

100 W/(m² * K) (default) | scalar with units of power/area/temperature

Lower bound for the heat transfer coefficient between fluid and wall. If calculation returns a lower heat transfer coefficient, this bound replaces the calculated value.

Effects and Initial Conditions

Gas initial temperature — Temperature in the gas 1 or gas 2 channel at the start of simulation

293.15 K (default) | scalar with units of temperature

Temperature in the gas 1 or gas 2 channel at the start of simulation.

Gas 1|2 initial pressure — Pressure in the gas 1 or gas 2 channel at the start of simulation

0.101325 MPa (default) | scalar with units of pressure

Pressure in the gas 1 or gas 2 channel at the start of simulation.

Extended Capabilities

C/C++ Code Generation

Generate C and C++ code using Simulink® Coder™.

See Also

E-NTU Heat Transfer | Heat Exchanger Interface (G) | Specific Dissipation Heat Transfer | Simple Heat Exchanger Interface (G)

Introduced in R2017b

Heat Exchanger (G-TL)

Heat exchanger for systems with gas and thermal liquid flows

Library: Simscape / Fluids / Fluid Network Interfaces / Heat Exchangers



Description

The Heat Exchanger (G-TL) block models the complementary cooling and heating of fluids held briefly in thermal contact across a thin conductive wall. The wall can store heat in its bounds, adding to the heat transfer a slight transient delay that scales in proportion to its thermal mass. The fluids are single phase—pure gas on one side, pure liquid on the other. Neither fluid can switch phase and so, as latent heat is never released, the exchange is strictly one of sensible heat.

Sensible heat exchangers abound in machinery. The fuel heaters that in some jets keep ice from precipitating in fuel lines and from choking fuel strainers work by blasting bleed air still hot from the compressor over the fuel lines. The oil coolers that in some motorcycles keep lubricating oil from overheating work likewise by rushing ram air at ambient temperature over the oil lines. The bleed and ram air are gas flows and the fuel and oil are thermal liquid flows.

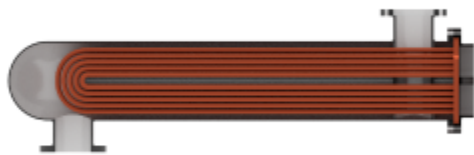

Block Variants

The heat transfer model depends on the choice of block variant. The block has two variants: E-NTU Model and Simple Model. Right-click the block to open its context-sensitive menu and select **Simscape > Block Choices** to change variant.

E-NTU Model

The default variant. Its heat transfer model derives from the Effectiveness-NTU method. Heat transfer in the steady state then proceeds at a fraction of the ideal rate which the flows, if kept each at its inlet temperature, and if cleared of every thermal resistance in between, could in theory support:

$$Q_{\text{Act}} = \epsilon Q_{\text{Max}},$$

where Q_{Act} the actual heat transfer rate, Q_{Max} is the ideal heat transfer rate, and ϵ is the fraction of the ideal rate actually observed in a real heat exchanger encumbered with losses. The fraction is the heat exchanger effectiveness, and it is a function of the number of transfer units, or NTU, a measure of the ease with which heat moves between flows, relative to the ease with which the flows absorb that heat:

$$NTU = \frac{1}{RC_{\text{Min}}},$$

where the fraction is the overall thermal conductance between the flows and C_{Min} is the smallest of the heat capacity rates from among the flows—that belonging to the flow least capable of absorbing heat. The heat capacity rate of a flow depends on the specific heat of the fluid (c_p) and on its mass flow rate through the exchanger (\dot{m}):

$$C = c_p \dot{m}.$$

The effectiveness depends also on the relative disposition of the flows, the number of passes between them, and the mixing condition for each. This dependence reflects in the effectiveness expression used, with different flow arrangements corresponding to different expressions. For a list of the effectiveness expressions, see the E-NTU Heat Transfer block.

Flow Arrangement

Use the **Flow arrangement** block parameter to set how the flows meet in the heat exchanger. The flows can run parallel to each other, counter to each other, or across each other. They can also run in a pressurized shell, one through tubes enclosed in the shell, the other around those same tubes. The figure shows an example. The tube flow can make one pass through the shell flow (shown right) or, for greater exchanger effectiveness, multiple passes (left).

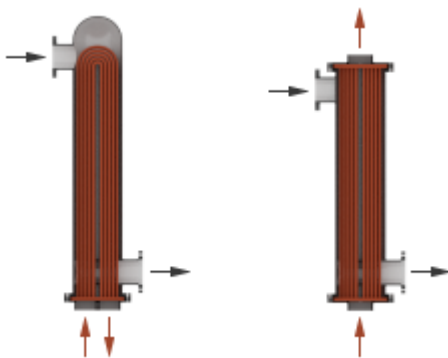

Other flow arrangements are possible through a generic parameterization based on tabulated effectiveness data and requiring little detail about the heat exchanger. Flow arrangement, mixing condition, and number of shell or tube passes, if relevant to the heat exchanger, are assumed to manifest in the tabulated data.

Mixing Condition

Use the **Cross flow arrangement** parameter to mix each of the flows, one of the flows, or none of the flows. Mixing in this context is the lateral movement of fluid in channels that have no internal barriers, normally guides, baffles, fins, or walls. Such movement serves to even out temperature

variations in the transverse plane. Mixed flows have variable temperature in the longitudinal plane alone. Unmixed flows have variable temperature in both the transverse and longitudinal planes. The figure shows a mixed flow (**i**) and an unmixed flow (**ii**).

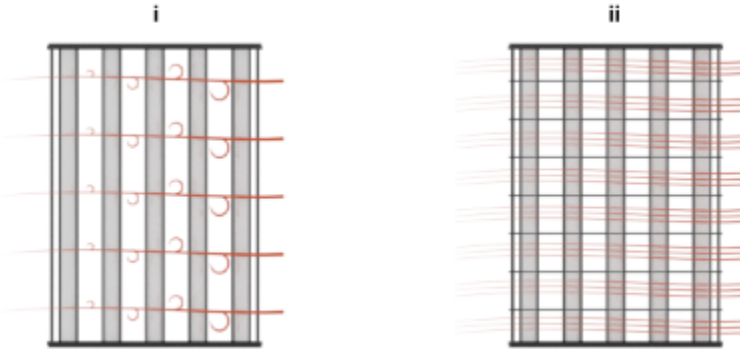

The distinction between mixed and unmixed flows is considered only in cross flow arrangements. There, longitudinal temperature variation in one fluid produces transverse temperature variation in the second fluid that mixing can even out. In counter and parallel flow arrangements, longitudinal temperature variation in one fluid produces longitudinal temperature variation in the second fluid and mixing, as it is of little effect here, is ignored.

Effectiveness Curves

Shell-and-tube exchangers with multiple passes (**iv.b-e** in the figure for 2, 3, and 4 passes) are most effective. Of exchangers with a single pass, those with counter flows (**ii**) are most effective and those with parallel flows (**i**) are least.

Cross-flow exchangers are intermediate in effectiveness, with mixing condition playing a factor. They are most effective when both flows are unmixed (**iii.a**) and least effective when both flows are mixed (**iii.b**). Mixing just the flow with the smallest heat capacity rate (**iii.c**) lowers the effectiveness more than mixing just the flow with the largest heat capacity rate (**iii.d**).

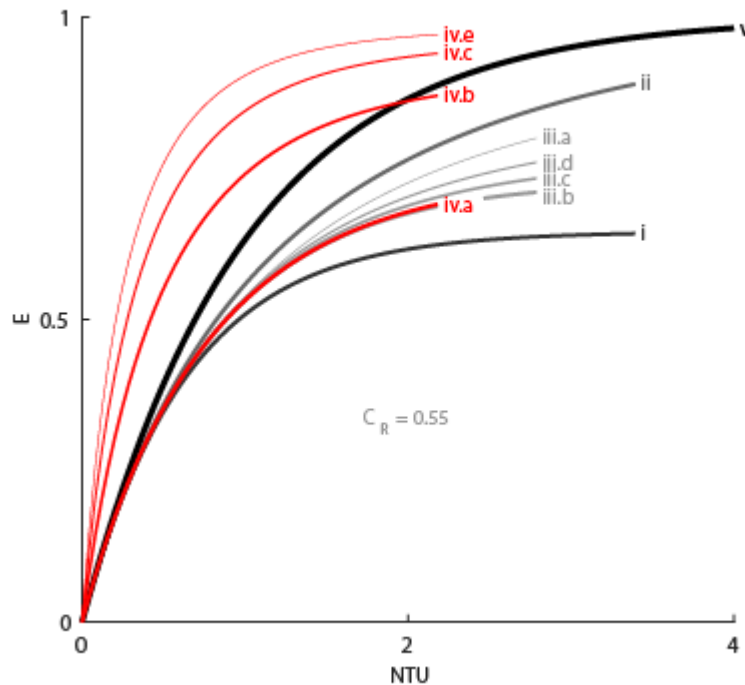

Thermal Resistance

The overall thermal resistance, R , is the sum of the local resistances lining the heat transfer path. The local resistances arise from convection at the surfaces of the wall, conduction through the wall, and, if the wall sides are fouled, conduction through the layers of fouling. Expressed in order from gas side to thermal liquid side:

$$R = \frac{1}{U_G A_{Th,G}} + \frac{F_G}{A_{Th,G}} + R_W + \frac{F_{TL}}{A_{Th,TL}} + \frac{1}{U_{TL} A_{Th,TL}}$$

where U is the convective heat transfer coefficient, F is the fouling factor, and A_{Th} is the heat transfer surface area, each for the flow indicated in the subscript. R_W is the thermal resistance of the wall.

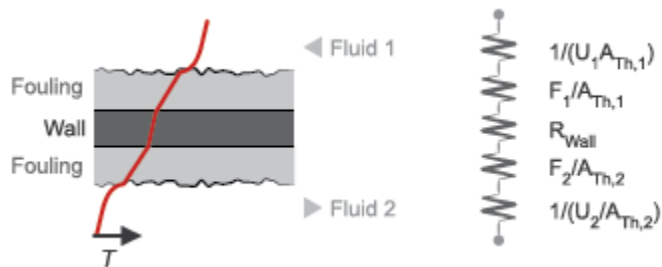

The wall thermal resistance and fouling factors are simple constants obtained from block parameters. The heat transfer coefficients are elaborate functions of fluid properties, flow geometry, and wall friction, and derive from standard empirical correlations between Reynolds, Nusselt, and Prandtl

numbers. The correlations depend on flow arrangement and mixing condition, and are detailed for each in the E-NTU Heat Transfer block on which the E-NTU Model variant is based.

Thermal Mass

The wall is more than a thermal resistance for heat to pass through. It is also a thermal mass and, like the flows it divides, it can store heat in its bounds. The storage slows the transition between steady states so that a thermal perturbation on one side does not promptly manifest on the side across. The lag persists for the short time that it takes the heat flow rates from the two sides to balance each other. That time interval scales with the thermal mass of the wall:

$$C_{Q,W} = c_{p,W}M_W,$$

where $c_{p,W}$ is the specific heat capacity and M_W the inertial mass of the wall. Their product gives the energy required to raise wall temperature by one degree. Use the **Wall thermal mass** block parameter to specify that product. The parameter is active when the **Wall thermal dynamics** setting is **On**.

Thermal mass is often negligible in low-pressure systems. Low pressure affords a thin wall with a transient response so fast that, on the time scale of the heat transfer, it is virtually instantaneous. The same is not true of high-pressure systems, common in the production of ammonia by the Haber process, where pressure can break 200 atmospheres. To withstand the high pressure, the wall is often thicker, and, as its thermal mass is heftier, so its transient response is slower.

Set the **Wall thermal dynamics** parameter to **Off** to ignore the transient lag, cut the differential variables that produce it, and, in reducing calculations, speed up the rate of simulation. Leave it **On** to capture the transient lag where it has a measurable effect. Experiment with the setting if necessary to determine whether to account for thermal mass. If simulation results differ to a considerable degree, and if simulation speed is not a factor, keep the setting **On**.

The wall, if modeled with thermal mass, is considered in halves. One half sits on the gas side and the other half sits on the thermal liquid side. The gas side is denoted side 1 and the thermal liquid side is denoted side 2. This notation is used in the calculations for heat transfer. The thermal mass divides evenly between the pair:

$$C_{Q,1} = C_{Q,2} = \frac{C_{Q,W}}{2}.$$

Energy is conserved in the wall. In the simple case of a wall half at steady state, heat gained from the fluid equals heat lost to the second half. The heat flows at the rate predicted by the E-NTU method for a wall without thermal mass. The rate is positive for heat flows directed from side 1 of the heat exchanger to side 2:

$$Q_1 = -Q_2 = \epsilon Q_{\text{Max}}.$$

In the transient state, the wall is in the course of storing or losing heat, and heat gained by one half no longer equals that lost to the second half. The difference in the heat flow rates varies over time in proportion to the rate at which the wall stores or loses heat. For side 1 of the heat exchanger:

$$Q_1 = \epsilon Q_{\text{Max}} + C_{Q,1}\dot{T}_{W,1},$$

where $\dot{T}_{W,1}$ is the rate of change in temperature in the wall half. Its product with the thermal mass of the wall half gives the rate at which heat accumulates there. That rate is positive when temperature

rises and negative when it drops. The closer the rate is to zero the closer the wall is to steady state. For side 2 of the heat exchanger: $Q_2 = -\epsilon Q_{\text{Max}} + C_{Q,2} \dot{T}_{W,2}$,

Composite Structure

The E-NTU Model variant is a composite component built from simpler blocks. A Heat Exchanger Interface (G) block models the gas flow, a Heat Exchanger Interface (TL) block models the thermal liquid flow, and an E-NTU Heat Transfer block models the heat exchanged across the wall between the flows. The figure shows the block connections for the E-NTU Model block variant.

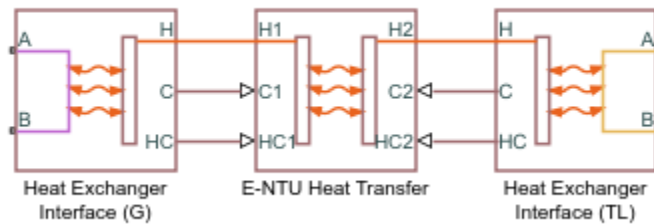

Simple Model

The alternative variant. Its heat transfer model depends on the concept of *specific dissipation*, a measure of the heat transfer rate observed when gas and thermal liquid inlet temperatures differ by one degree. Its product with the inlet temperature difference gives the expected heat transfer rate:

$$Q = \xi(T_{\text{In,G}} - T_{\text{In,TL}}),$$

where ξ is specific dissipation and T_{In} is inlet temperature for gas (subscript G) or thermal liquid (subscript TL). The specific dissipation is a tabulated function of the mass flow rates into the exchanger through the gas and thermal liquid inlets:

$$\xi = f(\dot{m}_{\text{In,G}}, \dot{m}_{\text{In,TL}}),$$

To accommodate reverse flows, the tabulated data can extend over positive and negative flow rates, in which case the inlets can also be thought of as outlets. The data normally derives from measurement of heat transfer rate against temperature in a real prototype:

$$\xi = \frac{Q}{T_{\text{In,G}} - T_{\text{In,TL}}}.$$

The heat transfer model, as it relies almost entirely on tabulated data, and as that data normally derives from experiment, requires little detail about the exchanger. Flow arrangement, mixing condition, and number of shell or tube passes, if relevant to the heat exchanger modeled, are assumed to manifest entirely in the tabulated data.

See the Specific Dissipation Heat Transfer block for more detail on the heat transfer calculations.

Composite Structure

The Simple Model variant is a composite component. A Simple Heat Exchanger Interface (G) block models the gas flow and a Simple Heat Exchanger Interface (TL) block models the thermal liquid flow. Mass, momentum, and energy conservation in the flow channels derive from the corresponding

interface blocks. A Specific Dissipation Heat Transfer block captures the heat exchanged across the wall between the flows.

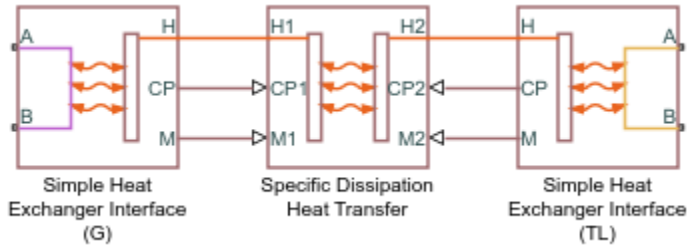

Ports

Conserving

A1 — Gas port

gas

Opening for gas to enter and exit its side of the heat exchanger.

B1 — Gas port

gas

Opening for gas to enter and exit its side of the heat exchanger.

A2 — Thermal liquid port

thermal liquid

Opening for thermal liquid to enter and exit its side of the heat exchanger.

B2 — Thermal liquid port

thermal liquid

Opening for thermal liquid to enter and exit its side of the heat exchanger.

Parameters

Block Variant: Simple Model

Heat Transfer

Gas 1 mass flow rate vector, $\mathit{mdot1}$ — Mass flow rate of gas at each breakpoint in lookup table for specific heat dissipation table

numerical array with units of mass over time

Mass flow rate of gas at each breakpoint in the lookup table for the specific heat dissipation table. The block inter- and extrapolates the breakpoints to obtain the specific heat dissipation at any mass flow rate. Interpolation is the MATLAB `linear` type and extrapolation is `nearest`.

The mass flow rates can be positive, zero, or negative, but they must increase monotonically from left to right. Their number must equal the number of rows in the **Specific heat dissipation** table

parameter. If the table has m rows and n columns, the mass flow rate vector must be m elements long.

Thermal Liquid 2 mass flow rate vector, mdot2 — Mass flow rate of thermal liquid at each breakpoint in lookup table for specific heat dissipation table

numerical array with units of mass over time

Mass flow rate of thermal liquid at each breakpoint in the lookup table for the specific heat dissipation table. The block inter- and extrapolates the breakpoints to obtain the specific heat dissipation of the heat exchanger at any mass flow rate. Interpolation is the MATLAB `linear` type and extrapolation is `nearest`.

The mass flow rates can be positive, zero, or negative, but they must increase monotonically from left to right. Their number must equal the number of columns in the **Specific heat dissipation table** parameter. If the table has m rows and n columns, the mass flow rate vector must be n elements long.

Specific heat dissipation table, $\text{SD}(\text{mdot1}, \text{mdot2})$ — Specific heat dissipation at each breakpoint in lookup table over mass flow rates of gas and thermal liquid

numerical array with units of power over temperature

Specific heat dissipation at each breakpoint in its lookup table over the mass flow rates of gas and thermal liquid. The block inter- and extrapolates the breakpoints to obtain the effectiveness at any pair of gas and thermal liquid mass flow rates. Interpolation is the MATLAB `linear` type and extrapolation is `nearest`.

The specific heat dissipation values must be not be negative. They must align from top to bottom in order of increasing mass flow rate in the gas channel, and from left to right in order of increasing mass flow rate in the thermal liquid channel. The number of rows must equal the size of the **Gas 1 mass flow rate vector** parameter, and the number of columns must equal the size of the **Thermal liquid 2 mass flow rate vector** parameter.

Check if violating maximum specific dissipation — Warning condition for specific heat dissipation in excess of minimum heat capacity rate

Warning (default) | None

Warning condition for specific heat dissipation in excess of minimum heat capacity rate. Heat capacity rate is the product of mass flow rate and specific heat, and its minimum value is the lowest between the flows. This minimum gives the specific dissipation for a heat exchanger with maximum effectiveness and cannot be exceeded. See the Specific Dissipation Heat Transfer block for more detail.

Gas 1

Mass flow rate vector — Mass flow rate at each breakpoint in lookup table for pressure drop

numerical array with units of mass per unit time

Mass flow rate at each breakpoint in the lookup table for the pressure drop. The block uses linear interpolation and nearest extrapolation to obtain the pressure drop at any mass flow rate.

The mass flow rates can be positive, zero, or negative and they can span across laminar, transient, and turbulent zones. The vector must have the same number of elements as the **Pressure drop vector** parameter and these elements must increase monotonically from left to right.

Pressure drop vector — Pressure drop at each breakpoint in lookup table over mass flow rate

numerical array with units of pressure

Pressure drop at each breakpoint in its lookup table over the mass flow rate. The block uses linear interpolation and nearest extrapolation to obtain the pressure drop at any mass flow rate.

The pressure drops can be positive, zero, or negative, and they can span across laminar, transient, and turbulent zones. The vector must have the same number of elements as the **Mass flow rate vector** parameter and these elements must increase monotonically from left to right.

Reference inflow temperature — Absolute inlet temperature assumed in tabulated data

293.15 K (default) | scalar with units of temperature

Absolute temperature established at the inlet in the gathering of the tabulated pressure drops. The reference inflow temperature and pressure determine the fluid density assumed in the tabulated data. During simulation, the ratio of reference to actual fluid densities multiplies the tabulated pressure drop to obtain the actual pressure drop.

Reference inflow pressure — Absolute inlet pressure assumed in tabulated data

0.101325 MPa (default) | scalar with units of pressure

Absolute pressure established at the inlet in the gathering of the tabulated pressure drops. The reference inflow temperature and pressure determine the fluid density assumed in the tabulated data. During simulation, the ratio of reference to actual fluid densities multiplies the tabulated pressure drop to obtain the actual pressure drop.

Mass flow rate threshold for flow reversal — Upper bound of numerically smooth region for mass flow rate

1e-3 kg/s (default) | scalar with units of mass/time

Mass flow rate below which its value is numerically smoothed to avoid discontinuities. See the Simple Heat Exchanger Interface block (on which the Simple Model variant is based) for detail on the calculations.

Gas 1 volume — Volume of fluid in the gas flow channel

0.01 m³ (default) | scalar with units of length cubed

Volume of fluid in the gas flow channel.

Cross-sectional area at ports A1 and B1 — Flow area at the inlet and outlet of the flow channel

0.01 m² (default) | scalar with units of length squared

Flow area at the inlet and outlet of the gas flow channel. Ports in the same flow channel are of the same size.

Thermal Liquid 2**Mass flow rate vector — Mass flow rate at each breakpoint in lookup table for pressure drop**

numerical array with units of mass per unit time

Mass flow rate at each breakpoint in the lookup table for the pressure drop. The block uses linear interpolation and nearest extrapolation to obtain the pressure drop at any mass flow rate.

The mass flow rates can be positive, zero, or negative and they can span across laminar, transient, and turbulent zones. The vector must have the same number of elements as the **Pressure drop vector** parameter and these elements must increase monotonically from left to right.

Pressure drop vector — Pressure drop at each breakpoint in lookup table over mass flow rate

numerical array with units of pressure

Pressure drop at each breakpoint in its lookup table over the mass flow rate. The block uses linear interpolation and nearest extrapolation to obtain the pressure drop at any mass flow rate.

The pressure drops can be positive, zero, or negative, and they can span across laminar, transient, and turbulent zones. The vector must have the same number of elements as the **Mass flow rate vector** parameter and these elements must increase monotonically from left to right.

Reference inflow temperature — Absolute inlet temperature assumed in tabulated data

293.15 K (default) | scalar with units of temperature

Absolute temperature established at the inlet in the gathering of the tabulated pressure drops. The reference inflow temperature and pressure determine the fluid density assumed in the tabulated data. During simulation, the ratio of reference to actual fluid densities multiplies the tabulated pressure drop to obtain the actual pressure drop.

Reference inflow pressure — Absolute inlet pressure assumed in tabulated data

0.101325 MPa (default) | scalar with units of pressure

Absolute pressure established at the inlet in the gathering of the tabulated pressure drops. The reference inflow temperature and pressure determine the fluid density assumed in the tabulated data. During simulation, the ratio of reference to actual fluid densities multiplies the tabulated pressure drop to obtain the actual pressure drop.

Threshold mass flow rate for flow reversal — Upper bound of numerically smooth region for mass flow rate

1e-3 kg/s (default) | scalar with units of mass/time

Mass flow rate below which its value is numerically smoothed to avoid discontinuities. See the Simple Heat Exchanger Interface block (on which the Simple Model variant is based) for detail on the calculations.

Fluid volume — Volume of fluid in the thermal liquid flow channel

0.01 m³ (default) | scalar with units of length cubed

Volume of fluid in the thermal liquid flow channel.

Cross-sectional area at ports A2 and B2 — Flow area at the inlet and outlet of the flow channel

0.01 m² (default) | scalar with units of length squared

Flow area at the inlet and outlet of the thermal liquid flow channel. Ports in the same flow channel are of the same size.

Block Variant: E-NTU Model**Common Tab****Flow arrangement — Manner in which the flows align in the heat exchanger**

Parallel or counter flow (default) | Shell and tube | Cross flow | Generic - effectiveness table

Manner in which the flows align in the heat exchanger. The flows can run parallel to each other, counter to each other, or across each other. They can also run in a pressurized shell, one through tubes enclosed in the shell, the other around those tubes. Other flow arrangements are possible through a generic parameterization based on tabulated effectiveness data and requiring little detail about the heat exchanger.

Number of shell passes — Number of times the flow traverses the shell before exiting

1 (default) | unitless scalar

Number of times the flow traverses the shell before exiting.

Dependencies

This parameter applies solely to the **Flow arrangement** setting of Shell and tube.

Cross flow type — Mixing condition in each of the flow channels

Both fluids mixed (default) | Both fluids unmixed | Thermal Liquid 1 mixed & Thermal Liquid 2 unmixed | Thermal Liquid 1 unmixed & Thermal Liquid 2 mixed

Mixing condition in each of the flow channels. Mixing in this context is the lateral movement of fluid as it proceeds along its flow channel toward the outlet. The flows remain separate from each other. Unmixed flows are common in channels with plates, baffles, or fins. This setting reflects in the effectiveness of the heat exchanger, with unmixed flows being most effective and mixed flows being least.

Dependencies

This parameter applies solely to the **Flow arrangement** setting of Shell and tube.

Number of heat transfer units vector, NTU — Number of transfer units at each breakpoint in lookup table for heat exchanger effectiveness

unitless numerical array

Number of transfer units at each breakpoint in the lookup table for the heat exchanger effectiveness number. The table is two-way, with both the number of transfer units and the thermal capacity ratio serving as independent coordinates. The block uses linear interpolation and nearest extrapolation to obtain the effectiveness at any number of transfer units.

The numbers specified must be greater than zero and increase monotonically from left to right. The size of the vector must equal the number of rows in the **Effectiveness table** parameter. If the table has m rows and n columns, the vector for the number of transfer units must be m elements long.

Dependencies

This parameter applies solely to the **Flow arrangement** setting of Generic - effectiveness table.

Thermal capacity ratio vector, CR — Thermal capacity ratio at each breakpoint in lookup table for heat exchanger effectiveness

unitless numerical array

Thermal capacity ratio at each breakpoint in lookup table for heat exchanger effectiveness. The table is two-way, with both the number of transfer units and the heat capacity rate ratio serving as independent coordinates. The block uses linear interpolation and nearest extrapolation to obtain the effectiveness at any thermal capacity ratio.

The thermal capacity ratios must be greater than zero and increase monotonically from left to right. The size of the vector must equal the number of columns in the **Nusselt number table** parameter. If the table has m rows and n columns, the vector for the thermal capacity ratio must be n elements long. The thermal capacity ratio is the fraction of minimum over maximum heat capacity rates.

Dependencies

This parameter applies solely to the **Flow arrangement** setting of Generic - effectiveness table.

Effectiveness table, E(NTU,CR) — Heat exchanger effectiveness at each breakpoint in lookup table over the number of transfer units and thermal capacity ratio

unitless numerical array

Heat exchanger effectiveness at each breakpoint in its lookup table over the number of transfer units and thermal capacity ratio. The block uses linear interpolation and nearest extrapolation to obtain the effectiveness at any pair of number of transfer units and thermal capacity ratio.

The effectiveness values must not be negative. They must align from top to bottom in order of increasing number of transfer units and from left to right in order of increasing thermal capacity ratio. The number of rows must equal the size of the **Number of heat transfer units vector** parameter, and the number of columns must equal the size of the **Thermal capacity ratio vector** parameter.

Dependencies

This parameter applies solely to the **Flow arrangement** setting of Generic - effectiveness table.

Wall thermal dynamics — Modeling assumption for transient response of wall to thermal changes

Off (default) | On

Modeling assumption for the transient response of the wall to thermal changes. Set to On to impart a thermal mass to the wall and to capture the delay in its transient response to changes in temperature or heat flux. Such delays are relevant in thick walls, such as those required to sustain high pressures. The default setting assumes a wall thin enough for its transient response to be virtually instantaneous on the time scale of the heat transfer.

Wall thermal mass — Heat required to raise wall temperature by one degree

447 J/K (default) | scalar with units of energy over temperature

Heat required to raise wall temperature by one degree. Thermal mass is the product of mass with specific heat and a measure of the ability to absorb heat. A wall with thermal mass has a transient response to sudden changes in surface temperature or heat flux. The larger the thermal mass, the slower that response, and the longer the time to steady state. The default value corresponds to a wall of stainless steel with a mass of approximately 1 kg.

Dependencies

This parameter applies solely to the **Wall thermal dynamics** setting of On.

Wall thermal resistance — Resistance of the wall to heat flow by thermal conduction

1.6e-4 K/W (default) | scalar with units of temperature over power

Resistance of the wall to heat flow by thermal conduction. Wall resistance adds to convective and fouling resistances to determine the overall heat transfer coefficient between the flows.

Gas 1**Minimum free-flow area — Cross-sectional area of the flow channel at its narrowest point**

0.01 m² (default) | scalar with units of length squared

Total area of the flow cross section measured where the channel is its narrowest and the flow its fastest. If the channel is a collection of ducts, tubes, slots, or grooves, the area is the sum over the collection (minus any occlusion due to walls, ridges, plates, and other barriers).

Hydraulic diameter for pressure loss — Effective diameter of the flow channel at its narrowest point

0.1 m (default) | scalar with units of length

Effective inner diameter of the flow at its narrowest point. For channels not circular in cross section, that diameter is of an imaginary circle equal in area to the flow cross section. Its value is the ratio of the minimum free-flow area to a fourth of its gross perimeter.

If the channel is a collection of ducts, tubes, slots, or grooves, the gross perimeter is the sum of the perimeters in the collection. If the channel is a single pipe or tube and it is circular in cross section, the hydraulic diameter is the same as the true diameter.

Gas volume — Total volume of fluid contained in the flow channel

0.01 m³ (default) | scalar with units of length squared

Total volume of fluid contained in the gas flow channel.

Laminar flow upper Reynolds number limit — Start of transition between laminar and turbulent zones

2000 (default) | unitless scalar

Start of transition between laminar and turbulent zones. Above this number, inertial forces take hold and the flow grows progressively turbulent. The default value is characteristic of circular pipes and tubes with smooth surfaces.

Turbulent flow lower Reynolds number limit — End of transition between laminar and turbulent zones

4000 (default) | unitless scalar

End of transition between laminar and turbulent zones. Below this number, viscous forces take hold and the flow grows progressively laminar. The default value is characteristic of circular pipes and tubes with smooth surfaces.

Pressure loss parameterization — Mathematical model for pressure loss by viscous friction

constant loss coefficient (default) | correlations for tubes | Tabulated data - Darcy friction factor vs. Reynolds number | Tabulated data - Euler number vs. Reynolds number

Mathematical model for pressure loss by viscous friction. This setting determines which expressions to use for calculation and which block parameters to specify as input. See the Heat Exchanger Interface (G) and Heat Exchanger Interface (TL) blocks for the calculations by parameterization.

Pressure loss coefficient — Aggregate loss coefficient for all flow resistances between the ports

0.1 (default) | unitless scalar

Aggregate loss coefficient for all flow resistances in the flow channel—including the wall friction responsible for major loss and the local resistances, due to bends, elbows, and other geometry changes, responsible for minor loss.

The loss coefficient is an empirical dimensionless number commonly used to express the pressure loss due to viscous friction. It can be calculated from experimental data or, in some cases, obtained from product data sheets.

Dependencies

This parameter applies solely to the **Pressure loss parameterization** setting of Constant loss coefficient.

Length of flow path from inlet to outlet — Distance traveled from port to port

1 m (default) | unitless scalar with units of length

Total distance the flow must travel to reach across the ports. In multi-pass shell-and-tube exchangers, the total distance is the sum over all shell passes. In tube bundles, corrugated plates, and other channels in which the flow is split into parallel branches, it is the distance covered in a single branch. The longer the flow path, the steeper the major pressure loss due to viscous friction at the wall.

Dependencies

This parameter applies solely to the **Pressure loss parameterization** setting of Correlations for tubes and Tabulated data - Darcy friction factor vs Reynolds number.

Aggregate equivalent length of local resistances — Aggregate minor pressure loss expressed as a length

0.1 m (default) | scalar with units of length

Aggregate minor pressure loss expressed as a length. This length is that which all local resistances, such as elbows, tees, and unions, would add to the flow path if in their place was a simple wall extension. The larger the equivalent length, the steeper the minor pressure loss due to the local resistances.

Dependencies

This parameter applies solely to the **Pressure loss parameterization** setting of Correlations for tubes.

Internal surface absolute roughness — Mean height of surface protrusions behind wall friction

15e-6 m (default) | scalar with units of length

Mean height of the surface protrusions from which wall friction arises. Higher protrusions mean a rougher wall for more friction and so a steeper pressure loss. Surface roughness features in the Haaland correlation from which the Darcy friction factor derives and on which the pressure loss calculation depends.

Dependencies

This parameter applies solely to the **Pressure loss parameterization** setting of Correlations for tubes.

Laminar friction constant for Darcy friction factor — Pressure loss correction for flow cross section in laminar flow conditions

64 (default) | unitless scalar

Pressure loss correction for flow cross section in laminar flow conditions. This parameter is commonly referred to as the shape factor. Its ratio to the Reynolds number gives the Darcy friction factor for the pressure loss calculation in the laminar zone. The default value belongs to cylindrical pipes and tubes.

The shape factor derives for certain shapes from the solution of the Navier-Stokes equations. A square duct has a shape factor of 56, a rectangular duct with aspect ratio of 2:1 has a shape factor of 62, and an annular tube has a shape factor of 96, as does a slender conduit between parallel plates.

Dependencies

This parameter applies solely to the **Pressure loss parameterization** setting of Correlations for tubes.

Reynolds number vector for Darcy friction factor — Reynolds number at each breakpoint in lookup table for Darcy friction factor

unitless numerical array

Reynolds number at each breakpoint in the lookup table for the Darcy friction factor. The block uses linear interpolation and nearest extrapolation to obtain the Darcy friction factor at any Reynolds number.

The Reynolds numbers must be greater than zero and increase monotonically from left to right. They can span across laminar, transient, and turbulent zones. Their number must equal the size of the **Darcy friction factor vector** parameter, with which they are to combine to complete the tabulated breakpoints.

Dependencies

This parameter applies solely to the **Pressure loss parameterization** setting of Tabulated data - Darcy friction factor vs. Reynolds number.

Darcy friction factor vector — Darcy friction factor at each breakpoint in lookup table over Reynolds number

unitless numerical array

Darcy friction factor at each breakpoint in its lookup table over the Reynolds number. The block uses linear interpolation and nearest extrapolation to obtain the Darcy friction factor at any Reynolds number.

The Darcy friction factors must not be negative and they must align from left to right in order of increasing Reynolds number. Their number must equal the size of the **Reynolds number vector for Darcy friction factor** parameter, with which they are to combine to complete the tabulated breakpoints.

Dependencies

This parameter applies solely to the **Pressure loss parameterization** setting of Tabulated data - Darcy friction factor vs. Reynolds number.

Reynolds number vector for Euler number – Reynolds number at each breakpoint in lookup table for Euler number

unitless numerical array

Reynolds number at each breakpoint in the lookup table for the Euler number. The block uses linear interpolation and nearest extrapolation to obtain the Euler number at any Reynolds number.

The Reynolds numbers must be greater than zero and increase monotonically from left to right. They can span across laminar, transient, and turbulent zones. Their number must equal the size of the **Euler number vector** parameter, with which they are to combine to complete the tabulated breakpoints.

Dependencies

This parameter applies solely to the **Pressure loss parameterization** setting of Tabulated data - Euler number vs. Reynolds number.

Euler number vector – Euler number at each breakpoint in lookup table over Reynolds number

unitless numerical array

Euler number at each breakpoint in its lookup table over the Reynolds number. The block uses linear interpolation and nearest extrapolation to obtain the Euler number at any Reynolds number.

The Euler numbers must not be negative and they must align from left to right in order of increasing Reynolds number. Their number must equal the size of the **Reynolds number vector for Euler number** parameter, with which they are to combine to complete the tabulated breakpoints.

Dependencies

This parameter applies solely to the **Pressure loss parameterization** setting of Tabulated data - Euler number vs. Reynolds number.

Heat transfer parameterization – Mathematical model for heat transfer between fluid and wall

Constant heat transfer coefficient (default) | Correlations for tubes | Tabulated data - Colburn factor vs. Reynolds number | Tabulated data - Nusselt number vs. Reynolds number & Prandtl number

Mathematical model for heat transfer between fluid and wall. The choice of model determines which expressions to apply and which parameters to specify for heat transfer calculation. See the E-NTU Heat Transfer block for the calculations by parameterization.

Heat transfer surface area – Effective surface area used in heat transfer between fluid and wall0.4 m² (default) | scalar with units of length squared

Effective surface area used in heat transfer between fluid and wall. The effective surface area is the sum of primary and secondary surface areas, or those of the wall, where it is exposed to fluid, and of the fins, if any are used. Fin surface area is normally scaled by a fin efficiency factor.

Fluid-wall heat transfer coefficient – Heat transfer coefficient for convection between fluid and wall0.4 m² (default) | unitless scalar

Heat transfer coefficient for convection between fluid and wall. Resistance due to fouling is captured separately in the **Fouling factor** parameter.

Dependencies

This parameter applies solely to the **Heat transfer parameterization** setting of Constant heat transfer coefficient.

Length of flow path for heat transfer – Characteristic length traversed in heat transfer between fluid and wall

1 m (default) | scalar with units of length

Characteristic length traversed in heat transfer between fluid and wall. This length factors in the calculation of the hydraulic diameter from which the heat transfer coefficient and the Reynolds number, as defined in the tabulated heat transfer parameterizations, derives.

Dependencies

This parameter applies solely to the **Heat transfer parameterization** setting of Tabulated data - Colburn factor vs. Reynolds number or Tabulated data - Nusselt number vs. Reynolds number & Prandtl number.

Nusselt number for laminar flow heat transfer – Constant assumed for Nusselt number in laminar flow

3.66 (default) | positive unitless scalar

Constant assumed for Nusselt number in laminar flow. The Nusselt number factors in the calculation of the heat transfer coefficient between fluid and wall, on which the heat transfer rate depends. The default value belongs to cylindrical pipes and tubes.

Dependencies

This parameter applies solely to the **Heat transfer parameterization** setting of Correlations for tubes.

Reynolds number vector for Colburn factor – Values of the Reynolds number at which to specify the Colburn factor data

unitless numerical array

Reynolds number at each breakpoint in the lookup table for the Colburn factor. The block uses linear interpolation and nearest extrapolation to obtain the Colburn factor at any Reynolds number.

The Reynolds numbers must be greater than zero and increase monotonically from left to right. They can span across laminar, transient, and turbulent zones. Their number must equal the size of the

Colburn factor vector parameter, with which they are to combine to complete the tabulated breakpoints.

Dependencies

This parameter applies solely to the **Heat transfer parameterization** setting of Tabulated data - Colburn factor vs. Reynolds number.

Colburn factor vector – Colburn factor at each breakpoint in lookup table over Reynolds number

unitless numerical array

Colburn factor at each breakpoint in its lookup table over the Reynolds number. The block uses linear interpolation and nearest extrapolation to obtain the Euler number at any Reynolds number.

The Colburn factors must not be negative and they must align from left to right in order of increasing Reynolds number. Their number must equal the size of the **Reynolds number vector for Colburn factor** parameter, with which they are to combine to complete the tabulated breakpoints.

Dependencies

This parameter applies solely to the **Heat transfer parameterization** setting of Tabulated data - Colburn factor vs. Reynolds number.

Reynolds number vector for Nusselt number – Reynolds number at each breakpoint in lookup table for Nusselt number

unitless numerical array

Reynolds number at each breakpoint in the lookup table for the Nusselt number. The table is two-way, with both Reynolds and Prandtl numbers serving as independent coordinates. The block uses linear interpolation and nearest extrapolation to obtain the Nusselt number at any Reynolds number.

The Reynolds numbers must be greater than zero and increase monotonically from left to right. They can span across laminar, transient, and turbulent zones. The size of the vector must equal the number of rows in the **Nusselt number table** parameter. If the table has m rows and n columns, the Reynolds number vector must be m elements long.

Dependencies

This parameter applies solely to the **Heat transfer parameterization** setting of Tabulated data - Nusselt number vs. Reynolds number & Prandtl number.

Prandtl number vector for Nusselt number – Prandtl number at each breakpoint in lookup table for Nusselt number

unitless numerical array

Prandtl number at each breakpoint in the lookup table for the Nusselt number. The table is two-way, with both Reynolds and Prandtl numbers serving as independent coordinates. The block uses linear interpolation and nearest extrapolation to obtain the Nusselt number at any Prandtl number.

The Prandtl numbers must be greater than zero and increase monotonically from left to right. They can span across laminar, transient, and turbulent zones. The size of the vector must equal the number of columns in the **Nusselt number table** parameter. If the table has m rows and n columns, the Prandtl number vector must be n elements long.

Dependencies

This parameter applies solely to the **Heat transfer parameterization** setting of Tabulated data - Nusselt number vs. Reynolds number & Prandtl number.

Nusselt number table, Nu (Re,Pr) — Nusselt number at each breakpoint in lookup table over Reynolds and Prandtl numbers

unitless numerical array

Nusselt number at each breakpoint in its lookup table over the Reynolds and Prandtl numbers. The block uses linear interpolation and nearest extrapolation to obtain the Nusselt number at any pair of Reynolds and Prandtl numbers. By determining the Nusselt number, the table feeds the calculation from which the heat transfer coefficient between fluid and wall derives.

The Nusselt numbers must be greater than zero. They must align from top to bottom in order of increasing Reynolds number and from left to right in order of increasing Prandtl numbers. The number of rows must equal the size of the **Reynolds number vector for Nusselt number** parameter, and the number of columns must equal the size of the **Prandtl number vector for Nusselt number** parameter.

Dependencies

This parameter applies solely to the **Heat transfer parameterization** setting of Tabulated data - Nusselt number vs. Reynolds number & Prandtl number.

Fouling factor — Measure of thermal resistance due to fouling deposits

1.6e-4 K/W (default) | scalar with units of temperature over power

Measure of thermal resistance due to fouling deposits which over time tend to build on the exposed surfaces of the wall. The deposits, as they impose between the fluid and wall a new solid layer through which heat must traverse, add to the heat transfer path an extra thermal resistance. Fouling deposits grow slowly and the resistance due to them is accordingly assumed constant during simulation.

Minimum fluid-wall heat transfer coefficient — Lower bound for the heat transfer coefficient

100 W/(m² * K) (default) | scalar with units of power/area/temperature

Lower bound for the heat transfer coefficient between fluid and wall. If calculation returns a lower heat transfer coefficient, this bound replaces the calculated value.

Thermal Liquid 2**Minimum free-flow area — Cross-sectional area of the flow channel at its narrowest point**

0.01 m² (default) | scalar with units of length squared

Total area of the flow cross section measured where the channel is its narrowest and the flow its fastest. If the channel is a collection of ducts, tubes, slots, or grooves, the area is the sum over the collection (minus any occlusion due to walls, ridges, plates, and other barriers).

Hydraulic diameter for pressure loss — Effective diameter of the flow channel at its narrowest point

0.1 m (default) | scalar with units of length

Effective inner diameter of the flow at its narrowest point. For channels not circular in cross section, that diameter is of an imaginary circle equal in area to the flow cross section. Its value is the ratio of the minimum free-flow area to a fourth of its gross perimeter.

If the channel is a collection of ducts, tubes, slots, or grooves, the gross perimeter is the sum of the perimeters in the collection. If the channel is a single pipe or tube and it is circular in cross section, the hydraulic diameter is the same as the true diameter.

Liquid volume — Total volume of fluid contained in the flow channel

0.01 m³ (default) | scalar with units of length squared

Total volume of fluid contained in the thermal liquid flow channel.

Laminar flow upper Reynolds number limit — Start of transition between laminar and turbulent zones

2000 (default) | unitless scalar

Start of transition between laminar and turbulent zones. Above this number, inertial forces take hold and the flow grows progressively turbulent. The default value is characteristic of circular pipes and tubes with smooth surfaces.

Turbulent flow lower Reynolds number limit — End of transition between laminar and turbulent zones

4000 (default) | unitless scalar

End of transition between laminar and turbulent zones. Below this number, viscous forces take hold and the flow grows progressively laminar. The default value is characteristic of circular pipes and tubes with smooth surfaces.

Pressure loss parameterization — Mathematical model for pressure loss by viscous friction

constant loss coefficient (default) | correlations for tubes | Tabulated data - Darcy friction factor vs. Reynolds number | Tabulated data - Euler number vs. Reynolds number

Mathematical model for pressure loss by viscous friction. This setting determines which expressions to use for calculation and which block parameters to specify as input. See the Heat Exchanger Interface (G) and Heat Exchanger Interface (TL) blocks for the calculations by parameterization.

Pressure loss coefficient — Aggregate loss coefficient for all flow resistances between the ports

0.1 (default) | unitless scalar

Aggregate loss coefficient for all flow resistances in the flow channel—including the wall friction responsible for major loss and the local resistances, due to bends, elbows, and other geometry changes, responsible for minor loss.

The loss coefficient is an empirical dimensionless number commonly used to express the pressure loss due to viscous friction. It can be calculated from experimental data or, in some cases, obtained from product data sheets.

Dependencies

This parameter applies solely to the **Pressure loss parameterization** setting of Constant loss coefficient.

Length of flow path from inlet to outlet – Distance traveled from port to port

1 m (default) | unitless scalar with units of length

Total distance the flow must travel to reach across the ports. In multi-pass shell-and-tube exchangers, the total distance is the sum over all shell passes. In tube bundles, corrugated plates, and other channels in which the flow is split into parallel branches, it is the distance covered in a single branch. The longer the flow path, the steeper the major pressure loss due to viscous friction at the wall.

Dependencies

This parameter applies solely to the **Pressure loss parameterization** setting of Correlations for tubes and Tabulated data - Darcy friction factor vs Reynolds number.

Aggregate equivalent length of local resistances – Aggregate minor pressure loss expressed as a length

0.1 m (default) | scalar with units of length

Aggregate minor pressure loss expressed as a length. This length is that which all local resistances, such as elbows, tees, and unions, would add to the flow path if in their place was a simple wall extension. The larger the equivalent length, the steeper the minor pressure loss due to the local resistances.

Dependencies

This parameter applies solely to the **Pressure loss parameterization** setting of Correlations for tubes.

Internal surface absolute roughness – Mean height of surface protrusions behind wall friction

15e-6 m (default) | scalar with units of length

Mean height of the surface protrusions from which wall friction arises. Higher protrusions mean a rougher wall for more friction and so a steeper pressure loss. Surface roughness features in the Haaland correlation from which the Darcy friction factor derives and on which the pressure loss calculation depends.

Dependencies

This parameter applies solely to the **Pressure loss parameterization** setting of Correlations for tubes.

Laminar friction constant for Darcy friction factor – Pressure loss correction for flow cross section in laminar flow conditions

64 (default) | unitless scalar

Pressure loss correction for flow cross section in laminar flow conditions. This parameter is commonly referred to as the shape factor. Its ratio to the Reynolds number gives the Darcy friction factor for the pressure loss calculation in the laminar zone. The default value belongs to cylindrical pipes and tubes.

The shape factor derives for certain shapes from the solution of the Navier-Stokes equations. A square duct has a shape factor of 56, a rectangular duct with aspect ratio of 2:1 has a shape factor of 62, and an annular tube has a shape factor of 96, as does a slender conduit between parallel plates.

Dependencies

This parameter applies solely to the **Pressure loss parameterization** setting of Correlations for tubes.

Reynolds number vector for Darcy friction factor – Reynolds number at each breakpoint in lookup table for Darcy friction factor

unitless numerical array

Reynolds number at each breakpoint in the lookup table for the Darcy friction factor. The block uses linear interpolation and nearest extrapolation to obtain the Darcy friction factor at any Reynolds number.

The Reynolds numbers must be greater than zero and increase monotonically from left to right. They can span across laminar, transient, and turbulent zones. Their number must equal the size of the **Darcy friction factor vector** parameter, with which they are to combine to complete the tabulated breakpoints.

Dependencies

This parameter applies solely to the **Pressure loss parameterization** setting of Tabulated data - Darcy friction factor vs. Reynolds number.

Darcy friction factor vector – Darcy friction factor at each breakpoint in lookup table over Reynolds number

unitless numerical array

Darcy friction factor at each breakpoint in its lookup table over the Reynolds number. The block uses linear interpolation and nearest extrapolation to obtain the Darcy friction factor at any Reynolds number.

The Darcy friction factors must not be negative and they must align from left to right in order of increasing Reynolds number. Their number must equal the size of the **Reynolds number vector for Darcy friction factor** parameter, with which they are to combine to complete the tabulated breakpoints.

Dependencies

This parameter applies solely to the **Pressure loss parameterization** setting of Tabulated data - Darcy friction factor vs. Reynolds number.

Reynolds number vector for Euler number – Reynolds number at each breakpoint in lookup table for Euler number

unitless numerical array

Reynolds number at each breakpoint in the lookup table for the Euler number. The block uses linear interpolation and nearest extrapolation to obtain the Euler number at any Reynolds number.

The Reynolds numbers must be greater than zero and increase monotonically from left to right. They can span across laminar, transient, and turbulent zones. Their number must equal the size of the **Euler number vector** parameter, with which they are to combine to complete the tabulated breakpoints.

Dependencies

This parameter applies solely to the **Pressure loss parameterization** setting of Tabulated data - Euler number vs. Reynolds number.

Euler number vector — Euler number at each breakpoint in lookup table over Reynolds number

unitless numerical array

Euler number at each breakpoint in its lookup table over the Reynolds number. The block uses linear interpolation and nearest extrapolation to obtain the Euler number at any Reynolds number.

The Euler numbers must not be negative and they must align from left to right in order of increasing Reynolds number. Their number must equal the size of the **Reynolds number vector for Euler number** parameter, with which they are to combine to complete the tabulated breakpoints.

Dependencies

This parameter applies solely to the **Pressure loss parameterization** setting of Tabulated data - Euler number vs. Reynolds number.

Heat transfer parameterization — Mathematical model for heat transfer between fluid and wall

Constant heat transfer coefficient (default) | Correlations for tubes | Tabulated data - Colburn factor vs. Reynolds number | Tabulated data - Nusselt number vs. Reynolds number & Prandtl number

Mathematical model for heat transfer between fluid and wall. The choice of model determines which expressions to apply and which parameters to specify for heat transfer calculation. See the E-NTU Heat Transfer block for the calculations by parameterization.

Heat transfer surface area — Effective surface area used in heat transfer between fluid and wall

0.4 m² (default) | scalar with units of length squared

Effective surface area used in heat transfer between fluid and wall. The effective surface area is the sum of primary and secondary surface areas, or those of the wall, where it is exposed to fluid, and of the fins, if any are used. Fin surface area is normally scaled by a fin efficiency factor.

Fluid-wall heat transfer coefficient — Heat transfer coefficient for convection between fluid and wall

0.4 m² (default) | unitless scalar

Heat transfer coefficient for convection between fluid and wall. Resistance due to fouling is captured separately in the **Fouling factor** parameter.

Dependencies

This parameter applies solely to the **Heat transfer parameterization** setting of Constant heat transfer coefficient.

Length of flow path for heat transfer — Characteristic length traversed in heat transfer between fluid and wall

1 m (default) | scalar with units of length

Characteristic length traversed in heat transfer between fluid and wall. This length factors in the calculation of the hydraulic diameter from which the heat transfer coefficient and the Reynolds number, as defined in the tabulated heat transfer parameterizations, derives.

Dependencies

This parameter applies solely to the **Heat transfer parameterization** setting of Tabulated data - Colburn factor vs. Reynolds number or Tabulated data - Nusselt number vs. Reynolds number & Prandtl number.

Nusselt number for laminar flow heat transfer – Constant assumed for Nusselt number in laminar flow

3.66 (default) | positive unitless scalar

Constant assumed for Nusselt number in laminar flow. The Nusselt number factors in the calculation of the heat transfer coefficient between fluid and wall, on which the heat transfer rate depends. The default value belongs to cylindrical pipes and tubes.

Dependencies

This parameter applies solely to the **Heat transfer parameterization** setting of Correlations for tubes.

Reynolds number vector for Colburn factor – Values of the Reynolds number at which to specify the Colburn factor data

unitless numerical array

Reynolds number at each breakpoint in the lookup table for the Colburn factor. The block uses linear interpolation and nearest extrapolation to obtain the Colburn factor at any Reynolds number.

The Reynolds numbers must be greater than zero and increase monotonically from left to right. They can span across laminar, transient, and turbulent zones. Their number must equal the size of the **Colburn factor vector** parameter, with which they are to combine to complete the tabulated breakpoints.

Dependencies

This parameter applies solely to the **Heat transfer parameterization** setting of Tabulated data - Colburn factor vs. Reynolds number.

Colburn factor vector – Colburn factor at each breakpoint in lookup table over Reynolds number

unitless numerical array

Colburn factor at each breakpoint in its lookup table over the Reynolds number. The block uses linear interpolation and nearest extrapolation to obtain the Euler number at any Reynolds number.

The Colburn factors must not be negative and they must align from left to right in order of increasing Reynolds number. Their number must equal the size of the **Reynolds number vector for Colburn factor** parameter, with which they are to combine to complete the tabulated breakpoints.

Dependencies

This parameter applies solely to the **Heat transfer parameterization** setting of Tabulated data - Colburn factor vs. Reynolds number.

Reynolds number vector for Nusselt number — Reynolds number at each breakpoint in lookup table for Nusselt number

unitless numerical array

Reynolds number at each breakpoint in the lookup table for the Nusselt number. The table is two-way, with both Reynolds and Prandtl numbers serving as independent coordinates. The block uses linear interpolation and nearest extrapolation to obtain the Nusselt number at any Reynolds number.

The Reynolds numbers must be greater than zero and increase monotonically from left to right. They can span across laminar, transient, and turbulent zones. The size of the vector must equal the number of rows in the **Nusselt number table** parameter. If the table has m rows and n columns, the Reynolds number vector must be m elements long.

Dependencies

This parameter applies solely to the **Heat transfer parameterization** setting of Tabulated data - Nusselt number vs. Reynolds number & Prandtl number.

Prandtl number vector for Nusselt number — Prandtl number at each breakpoint in lookup table for Nusselt number

unitless numerical array

Prandtl number at each breakpoint in the lookup table for the Nusselt number. The table is two-way, with both Reynolds and Prandtl numbers serving as independent coordinates. The block uses linear interpolation and nearest extrapolation to obtain the Nusselt number at any Prandtl number.

The Prandtl numbers must be greater than zero and increase monotonically from left to right. They can span across laminar, transient, and turbulent zones. The size of the vector must equal the number of columns in the **Nusselt number table** parameter. If the table has m rows and n columns, the Prandtl number vector must be n elements long.

Dependencies

This parameter applies solely to the **Heat transfer parameterization** setting of Tabulated data - Nusselt number vs. Reynolds number & Prandtl number.

Nusselt number table, Nu (Re,Pr) — Nusselt number at each breakpoint in lookup table over Reynolds and Prandtl numbers

unitless numerical array

Nusselt number at each breakpoint in its lookup table over the Reynolds and Prandtl numbers. The block uses linear interpolation and nearest extrapolation to obtain the Nusselt number at any pair of Reynolds and Prandtl numbers. By determining the Nusselt number, the table feeds the calculation from which the heat transfer coefficient between fluid and wall derives.

The Nusselt numbers must be greater than zero. They must align from top to bottom in order of increasing Reynolds number and from left to right in order of increasing Prandtl numbers. The number of rows must equal the size of the **Reynolds number vector for Nusselt number** parameter, and the number of columns must equal the size of the **Prandtl number vector for Nusselt number** parameter.

Dependencies

This parameter applies solely to the **Heat transfer parameterization** setting of Tabulated data - Nusselt number vs. Reynolds number & Prandtl number.

Fouling factor — Measure of thermal resistance due to fouling deposits

1.6e-4 K/W (default) | scalar with units of temperature over power

Measure of thermal resistance due to fouling deposits which over time tend to build on the exposed surfaces of the wall. The deposits, as they impose between the fluid and wall a new solid layer through which heat must traverse, add to the heat transfer path an extra thermal resistance. Fouling deposits grow slowly and the resistance due to them is accordingly assumed constant during simulation.

Minimum fluid-wall heat transfer coefficient — Lower bound for the heat transfer coefficient

100 W/(m² * K) (default) | scalar with units of power/area/temperature

Lower bound for the heat transfer coefficient between fluid and wall. If calculation returns a lower heat transfer coefficient, this bound replaces the calculated value.

Effects and Initial Conditions**Gas 1 initial temperature — Temperature in the gas channel at the start of simulation**

293.15 K (default) | scalar with units of temperature

Temperature in the gas channel at the start of simulation

Gas 1 initial pressure — Pressure in the gas channel at the start of simulation

0.101325 MPa (default) | scalar with units of pressure

Pressure in the gas channel at the start of simulation.

Thermal Liquid 2 dynamic compressibility — Option to model pressure dynamics in the thermal liquid channel

On (default) | Off

Option to model the pressure dynamics in the thermal liquid channel. Setting this parameter to Off removes the pressure derivative terms from the component energy and mass conservation equations. The pressure inside the heat exchanger is then reduced to the weighted average of the two port pressures.

Thermal Liquid 2 initial temperature — Temperature in the thermal liquid channel at the start of simulation

293.15 K (default) | scalar with units of temperature

Temperature in the thermal liquid channel at the start of simulation

Thermal Liquid 2 initial pressure — Pressure in the thermal liquid channel at the start of simulation

0.101325 MPa (default) | scalar with units of pressure

Pressure in the thermal liquid channel at the start of simulation.

Extended Capabilities**C/C++ Code Generation**

Generate C and C++ code using Simulink® Coder™.

See Also

E-NTU Heat Transfer | Heat Exchanger Interface (TL) | Heat Exchanger Interface (G) | Specific Dissipation Heat Transfer | Simple Heat Exchanger Interface (TL) | Simple Heat Exchanger Interface (G)

Introduced in R2019a

Heat Exchanger Interface (G)

Gas side of heat exchanger

Library: Simscape / Fluids / Fluid Network Interfaces / Heat Exchangers / Fundamental Components

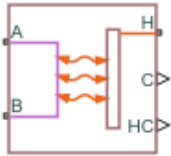

Description

The Heat Exchanger Interface (G) block models thermal transfer by a gaseous flow within a heat exchanger. Use a second heat exchanger block to model the fluid pair. The interfaces can be in different fluid domains, such as one in liquid and one in gas. Use an E-NTU Heat Transfer block to couple the interfaces and capture the heat exchange between the fluids.

Mass Balance

The fixed-volume construction of the block allows you to capture variations in fluid mass flow rates due to compressibility. The overall mass accumulation rate is equal to the sum of the mass flow rates through the ports:

$$\dot{M} = \dot{m}_A + \dot{m}_B,$$

where \dot{M} is the mass accumulation rate and \dot{m} is the mass flow rate. The subscripts denote ports **A** and **B**. The mass flow rate is positive when it is directed into the gas channel. Variations in density are reflected in the mass accumulation rate:

$$\dot{M} = \left[\left(\frac{\partial \rho}{\partial p} \right)_u \frac{dp}{dt} + \left(\frac{\partial \rho}{\partial u} \right)_p \frac{du}{dt} \right] V,$$

where:

- ρ is density.
- p is pressure.
- u is specific internal energy.
- V is volume.

Momentum Balance

Balancing momentum between the inlet and outlet ports of the heat exchanger dictates the flow direction and speed within the exchanger. Changes in momentum are due primarily due to friction losses from pipe turns, which translate to changes in pressure. Local resistances, such as bends, elbows, and tees can result in flow separation that leads to minor additional pressure losses. For steady flows, the mass flow rate remains constant.

A momentum balance is applied to each segment of the gas (pipe) volume. This figure shows a tube bank divided into two volumes and three nodes. The nodes correspond to ports **A**, **B**, and the fluid volume, **I**. Fluid states, such as pressure and temperature, and fluid properties, such as density and viscosity, are defined at these nodes.

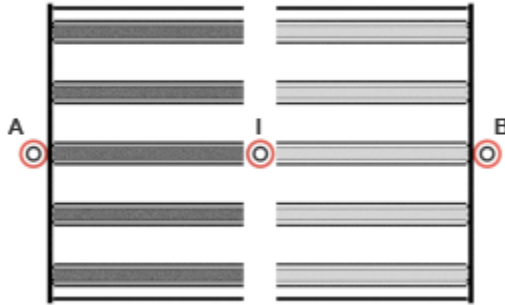

Note that flow inertia is negligible and the flow is considered to be quasi-steady state. The translation of transients to mass flow rates can be offset: due to coupling between density, pressure, and temperature, propagation of changes throughout the system is not instantaneous. Other sources and sinks of momentum, such as differences in head between ports or radial deformations of the channel wall, are not considered. The momentum balance for the half volume at port **A** is:

$$p_A - p_I = \Delta p_{f,A},$$

where p is the pressure at the node indicated in the subscript. $\Delta p_{f,A}$ is the total pressure loss between the port node and the internal node due to friction. The total pressure loss includes both major and minor losses. For the half volume at port **B**, the momentum balance is:

$$p_B - p_I = \Delta p_{f,B}.$$

Friction

Pressure changes due to friction vary with the square of the mass flow rate for turbulent flows and with the magnitude of the mass flow rate for laminar flows. This pressure change is characterized by three dimensionless parameters: the Darcy friction factor, the pressure loss coefficient, and the Euler number. These numbers are calculated from empirical correlations or are estimated from lookup tables, depending on the **Pressure loss parameterization** parameter.

Classification of "laminar" or "turbulent" flow is based on the Reynolds number. When the Reynolds number is above the **Turbulent flow lower Reynolds number limit** parameter, the flow is fully turbulent. Below the **Laminar flow upper Reynolds number limit** parameter, the flow is fully laminar. Reynolds numbers in between these values indicate transitional flow. Transitional flows show characteristics of both laminar and turbulent flows. In the Simscape Fluids language, numerical blending is applied between these bounding values.

Correlations for tubes

For tubes, the Darcy friction factor, f_D , is used. In the half volume at port **A**, the momentum balance is:

$$p_A - p_I = \frac{f_{D,A} \dot{m}_A |\dot{m}_A| (L + L_{\text{Add}})}{2\rho_A D_H A_{\text{Min}}^2} \left(\frac{L + L_{\text{Add}}}{2} \right),$$

where L is the tube length and L_{Add} is the added tube length that would reproduce the minor viscous losses if used in place of elbows, tees, unions, or other local resistances. A is the tube cross-sectional area; in the event of a non-uniform cross-sectional area, A_{min} should be used. D_H is the tube hydraulic diameter, or the diameter of a circle equal in area to the tube cross section:

$$D_H = \sqrt{\frac{4A_{\text{Min}}}{\pi}}.$$

If the tube has a circular cross section, the hydraulic diameter and the tube diameter are the same.

For the half volume at port **B**, the momentum balance is:

$$p_B - p_I = \frac{f_{D,B} \dot{m}_B |\dot{m}_B| (L + L_{\text{Add}})}{2\rho_B D_H A_{\text{Min}}^2} \left(\frac{L + L_{\text{Add}}}{2} \right).$$

For turbulent flows, the Darcy friction factor is calculated with the Haaland correlation. The Reynolds number is established at the bounding port:

$$f_D = \left\{ -1.8 \log_{10} \left[\frac{6.9}{\text{Re}} + \left(\frac{\epsilon_R}{3.7 D_H} \right)^{1.11} \right] \right\}^{-2},$$

where ϵ_R is wall roughness, taken as a characteristic height. This parameter is specified in the **Internal surface absolute roughness** parameter.

For laminar flows, the friction factor depends on the tube shape and is calculated with the tube shape factor:

$$f_D = \frac{\lambda}{\text{Re}},$$

where λ is the shape factor. The Reynolds number is calculated at the bounding port as:

$$\text{Re} = \frac{D_H \dot{m}}{\mu A_{\text{Min}}}.$$

Substituting Re into the pressure loss equation at port **A**, the momentum balance is reformulated as:

$$p_A - p_I = \frac{\lambda_A \mu_A \dot{m}_A}{2\rho_A D_H^2 A_{\text{Min}}} \left(\frac{L + L_{\text{Add}}}{2} \right),$$

Likewise, for the half volume at port **B**, the momentum balance is:

$$p_B - p_I = \frac{\lambda_B \mu_B \dot{m}_B}{2\rho_B D_H^2 A_{\text{Min}}} \left(\frac{L + L_{\text{Add}}}{2} \right).$$

Using the constant loss coefficient

For channels other than tubes, use the pressure loss coefficient, ξ . For turbulent flows in the half volume at port **A**, the momentum balance is:

$$p_A - p_I = \frac{1}{2} \xi \frac{\dot{m}_A |\dot{m}_A|}{2\rho_A A_{\text{Min}}^2},$$

For turbulent flows in the half volume at port **B**, the momentum balance is:

$$p_B - p_I = \frac{1}{2} \xi \frac{\dot{m}_B |\dot{m}_B|}{2\rho_B A_{\text{Min}}^2},$$

For laminar flows in the half volume at port **A**, the momentum balance is:

$$p_A - p_I = \frac{1}{2} \xi \text{Re}_L \frac{\dot{m}_A \mu_A}{2D_H \rho_A A_{\text{Min}}},$$

where Re_L is the **Laminar flow upper Reynolds number limit** block parameter. For laminar flows in the half volume at port **B**, the momentum balance is:

$$p_B - p_I = \frac{1}{2} \xi \text{Re}_L \frac{\dot{m}_B \mu_B}{2D_H \rho_B A_{\text{Min}}}$$

Using Tabulated data - Darcy friction factor vs. Reynolds number

You can use tabulated data to determine the Darcy friction factor based on the Reynolds number for tube flows. For the half volume at port **A**, the momentum balance is:

$$p_A - p_I = \frac{f_{D,A} \dot{m}_A |\dot{m}_A|}{2\rho_A D_H A_{\text{Min}}^2} \left(\frac{L + L_{\text{Add}}}{2} \right).$$

For the half volume at port **B**, the momentum balance is:

$$p_B - p_I = \frac{f_{D,B} \dot{m}_B |\dot{m}_B|}{2\rho_B D_H A_{\text{Min}}^2} \left(\frac{L + L_{\text{Add}}}{2} \right).$$

For the turbulent regime, the friction factor is determined from a tabulated function of the Reynolds number:

$$f_D = f_D(\text{Re}).$$

The breakpoints of the tabulated function derive from the vector block parameters. The **Reynolds number vector for Darcy friction factor** parameter specifies the independent variable and the **Darcy friction factor vector** parameter specifies the dependent variable. Linear interpolation is applied between breakpoints. Outside of the tabulated data range, the nearest breakpoint determines the friction factor.

In the laminar regime, the friction factor is calculated from the shape factor, λ :

$$f_D = \frac{\lambda}{\text{Re}}.$$

Using Tabulated data - Euler number vs. Reynolds number

You can use tabulated data to determine the Euler number based on the Reynolds number. This calculation is dependent on flow regime, and the Euler number is formulated as a tabulated function of the Reynolds number:

$$Eu = Eu(Re).$$

The breakpoints in Tabulated data - Euler number vs. Reynolds number are specified by Reynolds number and Euler number vectors. The **Reynolds number vector for Euler number** parameter specifies the independent variables, the Reynolds numbers, and the **Euler number vector** parameter specifies the dependent variable, the Euler number, at each Reynolds number. Linear interpolation is used to determine values between breakpoints. Outside of the tabulated data range, the value at the nearest breakpoint is used.

For turbulent flows, the momentum balance for the half volume at port **A** is:

$$p_A - p_I = Eu_A \frac{\dot{m}_A |\dot{m}_A|}{\rho_A A_{Min}^2},$$

where Eu is the Euler number at port **A**. For turbulent flows, the momentum balance for the half volume at port **B** is:

$$p_B - p_I = Eu_B \frac{\dot{m}_B |\dot{m}_B|}{\rho_B A_{Min}^2}.$$

For laminar flow in the half volume at port **A**, the momentum balance is:

$$p_A - p_I = Eu_L Re_L \frac{\dot{m}_A \mu_A}{4D_H \rho_A A_{Min}},$$

where Re_L is the **Laminar flow upper Reynolds number limit** parameter and Eu_L is the Euler number evaluated from tabulated data at that Reynolds number. For laminar flow in the half volume at port **B**, the momentum balance is:

$$p_B - p_I = Eu_L Re_L \frac{\dot{m}_B \mu_B}{4D_H \rho_B A_{Min}},$$

Energy Balance

The energy balance within the gas volume is the sum of its flow rates across channel boundaries and the associated heat transfer. Energy can be transferred by advection at the ports and by convection at the wall. While conduction contributes to the energy balance at the ports, it is often negligible in comparison to advection. However, conduction is non-negligible in near-stationary fluids, such as when fluids are stagnant or changing direction. The energy balance equation is:

$$\dot{E}_{2P} = \phi_A + \phi_B + Q,$$

where:

- $\frac{\partial U}{\partial p}$ is the partial derivative of the internal energy of the gas volume with respect to pressure at constant temperature and volume.
- p_I is the pressure of the gas volume.
- $\frac{\partial U}{\partial T}$ is the partial derivative of the internal energy of the gas volume with respect to temperature at constant pressure and volume.
- T_I is the temperature of the gas volume.

- Φ_A and Φ_B are energy flow rates at ports **A** and **B**, respectively.
- Q is the heat transfer rate.

Advection and conduction are accounted for in Φ , and convection is accounted for in Q . The heat transfer rate is positive when directed into the gas volume.

Heat Transfer Rate

Heat transfer between the two heat exchanger fluids occurs in multiple ways: through convection at the fluid interfaces, conduction through layers of built-up fouling, and conduction through the thickness of the wall.

Heat transfer extends beyond the gas channel and therefore requires other blocks to model the entire heat exchanger system. A second heat exchanger interface block models the second flow channel while an E-NTU Heat Transfer block models the heat flow across the wall. Heat transfer parameters that are specific to the gas channel, but required by the E-NTU Heat Transfer block, are available through the physical signal ports:

- Port **C** outputs the heat capacity rate, which is a measure of the gas' ability to absorb heat and is required for calculating the number of heat transfer units (NTU). The heat capacity rate is calculated as:

$$C_R = c_p \dot{m},$$

where C_R is the heat capacity rate and c_p is the specific heat.

- Port **HC** outputs the heat transfer coefficient, U .

If the heat transfer coefficient is treated as a constant, its value is uniform across the flow channel. If the heat transfer coefficient is variable, it is calculated at each port from the expression:

$$U = \frac{Nu k}{D_{H,Q}},$$

where Nu is Nusselt number, k is thermal conductivity, and $D_{H,Q}$ is a hydraulic diameter for heat transfer. The hydraulic diameter $D_{H,Q}$ is calculated as:

$$D_{H,Q} = \frac{4A_{Min}L_Q}{S_Q},$$

where S_Q is the **Heat transfer surface area** parameter and L_Q is the **Length of flow path for heat transfer** parameter.

The lower bound of the mean heat transfer coefficient is the **Minimum gas-wall heat transfer coefficient** parameter.

Nusselt Number

The Nusselt number is derived from empirical correlations with the Reynolds and Prandtl numbers. Use the **Heat transfer parametrization** parameter to select the most appropriate formulation for your simulation.

The simplest parameterization, **Constant heat transfer coefficient**, obtains the heat transfer coefficient directly from the value of the **Gas-wall heat transfer coefficient** parameter.

Correlations for tubes uses analytical expressions with constant or calculated parameters to capture Nusselt number dependence on the flow regime for tube flows.

The remaining parameterizations are tabulated functions of the Reynolds number. These are useful for varying Nusselt numbers, or heat transfer coefficients, across flow regimes. The functions are generated from experimental data relating the Reynolds number to the Colburn factor or the Reynolds and Prandtl numbers to the Nusselt number.

Constant heat transfer coefficient

Using **Constant heat transfer coefficient**, specified in the **Gas-wall heat transfer coefficient** parameter, sets the heat transfer coefficient as a constant, and does not use the Nusselt number in calculations. Use this parameterization as a simple approximation for gas flows confined to the laminar regime.

Correlation for tubes

The Nusselt number depends on flow regime when using **Correlation for tubes**. For turbulent flows, its value changes in proportion to the Reynolds number and is calculated from the Gnielinski correlation:

$$\text{Nu} = \frac{\frac{f}{8}(\text{Re} - 1000)\text{Pr}}{1 + 12.7\sqrt{\frac{f}{8}(\text{Pr}^{2/3} - 1)}}$$

where Re is the Reynolds number, Nu is the Nusselt number, and Pr is the Prandtl number. The friction factor, f , is the same as the factor used in tube pressure loss calculations. For laminar flows, the Nusselt number is a constant. Its value is obtained from the **Nusselt number for laminar flow heat transfer** parameter, Nu_L :

$$\text{Nu} = \text{Nu}_L.$$

Using Tabulated data - Colburn factor vs. Reynolds number

You can use tabulated data to determine the Colburn factor based on the Reynolds number. The Colburn equation is used to determine the Nusselt number, which varies in proportion to the Reynolds number. The Colburn j -factor is a measure of proportionality between the Reynolds, Prandtl, and Nusselt numbers:

$$\text{Nu} = j(\text{Re}_Q)\text{Re}_Q\text{Pr}^{1/3}.$$

Re_Q is the Reynolds number based on the hydraulic diameter for heat transfer, $D_{H,Q}$, and from the minimum free-flow area of the channel, A_{Min} :

$$\text{Re}_Q = \frac{\dot{m}D_{H,Q}}{A_{\text{Min}}\mu}$$

Using Tabulated data - Nusselt number vs. Reynolds number & Prandtl number

You can use a tabulated function to determine the Nusselt number from the Prandtl and Reynolds numbers. Linear interpolation is used to determine values between breakpoints. The Nusselt number is a function of both Re and Pr, and therefore the **Reynolds number vector for Nusselt number**, **Prandtl number vector for Nusselt number**, and **Nusselt number table, Nu(Re,Pr)** parameters define the table breakpoints:

$$\text{Nu} = \text{Nu}(\text{Re}_Q, \text{Pr}).$$

The tabulated Reynolds number must be calculated using the hydraulic diameter for heat transfer, $D_{H,Q}$.

Ports

Conserving

A — Gas port

gas

Entry or exit point on the gas side of the heat exchanger.

B — Gas port

gas

Entry or exit point on the gas side of the heat exchanger.

H — Thermal boundary

thermal

Thermal boundary between the modeled fluid and the heat exchanger interface.

Input

C — Heat capacity rate

physical signal

Instantaneous value of the heat capacity rate for the gas flow, specified as a physical signal.

HC — Heat transfer coefficient

physical signal

Instantaneous value of the heat transfer coefficient between gas flow and the wall, specified as a physical signal.

Parameters

Parameters Tab

Minimum free-flow area — Cross-sectional area of flow channel at its narrowest point

0.01 m² (default) | scalar with units of length squared

Cross-sectional area of the flow channel at its narrowest point. If the channel is a collection of ducts, tubes, slots, or grooves, this area is the sum of the areas in the collection, minus the blockage due to walls, ridges, plates, or other barriers.

Hydraulic diameter — Diameter or equivalent diameter of a circular channel

0.1 m (default) | scalar with units of length

Effective inner diameter of the flow. If the diameter of the cross-section varies, the value of this parameter is the diameter at its narrowest point. For non-circular channels, the hydraulic diameter is the equivalent diameter of a circle with the same area of the existing channel.

If the channel is a collection of ducts, tubes, slots, or grooves, the gross perimeter is the sum of the perimeters in the collection. If the channel is a single pipe or tube that has a circular cross section, the hydraulic diameter is equal to the true diameter.

Gas volume — Total volume of fluid contained in flow channel

0.01 m³ (default) | scalar with units of length squared

Total volume of the fluid contained in the gas or thermal liquid flow channel.

Laminar flow upper Reynolds number limit — Start of transition between laminar and turbulent regimes

2000 (default) | scalar

Start of the transition from the laminar regime to the turbulent regime. Above this number, inertial forces become increasingly dominant. The default value is given for circular pipes and tubes with smooth surfaces.

Turbulent flow lower Reynolds number limit — End of transition between laminar and turbulent regimes

4000 (default) | scalar

End of the transition from the laminar regime to the turbulent regime. Below this number, viscous forces become increasingly dominant. The default value is for circular pipes and tubes with smooth surfaces.

Pressure loss parameterization — Mathematical model for pressure loss due to friction

constant loss coefficient (default) | correlations for tubes | Tabulated data - Darcy friction factor vs. Reynolds number | Tabulated data - Euler number vs. Reynolds number

Mathematical model for pressure loss due to friction. This setting determines which expressions to use for calculation and which block parameters to specify as input. See the Heat Exchanger Interface (TL) blocks for the calculations by parameterization.

Pressure loss coefficient — Aggregate loss coefficient for all flow resistances between the ports

0.1 (default) | scalar

Aggregate loss coefficient for all flow resistances in the flow channel, including wall friction (major losses) and local resistances due to bends, elbows, and other geometry changes (minor losses).

The loss coefficient is an empirical, dimensionless number used to express the pressure losses due to friction. It can be calculated from experimental data or obtained from product data sheets.

Dependencies

To enable this parameter, set **Pressure loss parameterization** to Constant loss coefficient.

Length of flow path from inlet to outlet — Distance traveled from port to port

1 m (default) | scalar with units of length

Total distance the flow must travel between the ports. In multi-pass shell-and-tube exchangers, the total distance is the sum over all shell passes. In tube bundles, corrugated plates, and other channels where the flow is split into parallel branches, it is the distance covered in a single branch. The longer the flow path, the steeper the major pressure loss due to friction at the wall.

Dependencies

To enable this parameter, set **Pressure loss parameterization** to Correlations for tubes or Tabulated data - Darcy friction factor vs Reynolds number.

Aggregate equivalent length of local resistances — Aggregate minor pressure loss expressed in length

0.1 m (default) | scalar with units of length

Aggregate minor pressure loss, expressed as a length. The length of a straight channel results in equivalent losses to the sum of existing local resistances from elbows, tees, and unions. The larger the equivalent length, the steeper the minor pressure loss due to the local resistances.

Dependencies

To enable this parameter, set **Pressure loss parameterization** to Correlations for tubes.

Internal surface absolute roughness — Mean height of wall surface variations that contribute to frictional losses

15e-6 m (default) | scalar with units of length

Mean height of the wall surface variations that contribute to frictional losses. The greater the mean height, the rougher the wall and the larger the pressure loss due to friction. Surface roughness is required to derive the Darcy friction factor from the Haaland correlation.

Dependencies

To enable this parameter, set **Pressure loss parameterization** to Correlations for tubes.

Laminar friction constant for Darcy friction factor — Pressure loss correction for flow cross section in laminar flow conditions

64 (default) | scalar

Pressure loss correction for laminar flow. This parameter is referred to as the shape factor, and can be used to derive the Darcy friction factor for pressure loss calculations in the laminar regime. The default value is for cylindrical pipes and tubes.

Some additional shape factors for non-circular cross-sections can be determined from analytical solutions to the Navier-Stokes equations. A square duct has a shape factor of 56, a rectangular duct with an aspect ratio of 2:1 has a shape factor of 62, and an annular tube has a shape factor of 96. A slender conduit between parallel plates also has a shape factor of 96.

Dependencies

To enable this parameter, set **Pressure loss parameterization** to Correlations for tubes.

Reynolds number vector for Darcy friction factor — Reynolds number at each breakpoint in Darcy friction factor lookup table

numerical array

Reynolds number at each breakpoint in the lookup table for the Darcy friction factor. The block interpolates between and extrapolates from the breakpoints to obtain the Darcy friction factor at any Reynolds number. Interpolation is handled by the MATLAB® `linear` estimator and extrapolation is handled by the `nearest` function.

The Reynolds numbers must be greater than zero and increase monotonically from left to right. They can span across laminar, transient, and turbulent regimes. The number of values in this vector must

be equal to the size of the **Darcy friction factor vector** parameter to calculate tabulated breakpoints.

Dependencies

To enable this parameter, set **Pressure loss parameterization** to Tabulated data - Darcy friction factor vs. Reynolds number.

Darcy friction factor vector — Darcy friction factor at each breakpoint in Reynolds number lookup table

numerical array

Darcy friction factor at each breakpoint in the lookup table of Reynolds numbers. The block interpolates between and extrapolates from the breakpoints to obtain the Darcy friction factor at any Reynolds number. Interpolation is handled by the MATLAB `linear` estimator and extrapolation is handled by the `nearest` function.

The Darcy friction factor must not be negative and must align from left to right in order of increasing Reynolds number. The number of values in this vector must be equal to the size of the **Reynolds number vector for Darcy friction factor** parameter to calculate tabulated breakpoints.

Dependencies

To enable this parameter, set **Pressure loss parameterization** to Tabulated data - Darcy friction factor vs. Reynolds number.

Reynolds number vector for Euler number — Reynolds number at each breakpoint in the Euler number lookup table

numerical array

Reynolds number at each breakpoint in the Euler number lookup table. The block interpolates between and extrapolates from the breakpoints to obtain the Reynolds number at any Euler number. Interpolation is handled by the MATLAB `linear` estimator and extrapolation is handled by the `nearest` function.

The Reynolds numbers must be greater than zero and increase monotonically from left to right. They can span across laminar, transient, and turbulent regimes. The number of values in this vector must be equal to the size of the **Euler number vector** parameter to calculate tabulated breakpoints.

Dependencies

To enable this parameter, set **Pressure loss parameterization** to Tabulated data - Euler number vs. Reynolds number.

Euler number vector — Euler number at each breakpoint in the Reynolds number lookup table

numerical array

Euler number at each breakpoint in the Reynolds number lookup table. The block interpolates between and extrapolates from the breakpoints to obtain the Euler number at any Reynolds number. Interpolation is handled by the MATLAB `linear` estimator and extrapolation is handled by the `nearest` function.

The Euler number must not be negative and must align from left to right in order of increasing Reynolds number. The number of values in this vector must be equal to the size of the **Reynolds number vector for Euler number** parameter to calculate tabulated breakpoints.

Dependencies

To enable this parameter, set **Pressure loss parameterization** to Tabulated data - Euler number vs. Reynolds number.

Heat transfer parameterization — Mathematical model for heat transfer between fluid and wall

Constant heat transfer coefficient (default) | Correlations for tubes | Tabulated data - Colburn factor vs. Reynolds number | Tabulated data - Nusselt number vs. Reynolds number & Prandtl number

Mathematical model for heat transfer between the fluid and the wall. The choice of model determines which expressions to apply and which parameters to specify for heat transfer calculations. See the E-NTU Heat Transfer block for the calculations by parameterization.

Gas-wall heat transfer coefficient — Heat transfer coefficient for convection between fluid and wall

100 W/(m² * K) (default) | scalar

Heat transfer coefficient for convection between the fluid and the wall.

Dependencies

To enable this parameter, set **Heat transfer parameterization** to Constant heat transfer coefficient.

Heat transfer surface area — Effective surface area used in heat transfer between fluid and wall

0.4 m² (default) | scalar with units of length squared

Effective surface area used in heat transfer between the fluid and the wall. The effective surface area is the sum of primary and secondary surface areas, the area where the wall is exposed to fluid and the fins, if any are used. Fin surface area is normally scaled by a fin efficiency factor.

Length of flow path for heat transfer — Characteristic length traversed in heat transfer between fluid and wall

1 m (default) | scalar with units of length

Characteristic length for heat transfer between fluid and wall. This length is used to determine the channel hydraulic diameter.

Dependencies

To enable this parameter, set **Heat transfer parameterization** to Tabulated data - Colburn factor vs. Reynolds number or Tabulated data - Nusselt number vs. Reynolds number & Prandtl number.

Nusselt number for laminar flow heat transfer — Constant assumed for Nusselt number in laminar flow

3.66 (default) | positive scalar

Constant value of the Nusselt number for laminar flows. The Nusselt number is required to calculate the heat transfer coefficient between the fluid and the wall. The default value is for cylindrical pipes and tubes.

Dependencies

To enable this parameter, set **Heat transfer parameterization** to Correlations for tubes.

Reynolds number vector for Colburn factor — Reynolds number at each breakpoint in Colburn factor lookup table

numerical array

Reynolds number at each breakpoint in the Colburn factor lookup table. The block interpolates between and extrapolates from the breakpoints to obtain the Colburn factor at any Reynolds number. Interpolation is handled by the MATLAB linear estimator and extrapolation is handled by the nearest function.

The Reynolds numbers must be greater than zero and increase monotonically from left to right. They can span across laminar, transient, and turbulent regimes. The number of values in this vector must be equal to the size of the **Colburn factor vector** parameter to calculate tabulated breakpoints.

Dependencies

To enable this parameter, set **Heat transfer parameterization** to Tabulated data - Colburn factor vs. Reynolds number.

Colburn factor vector — Colburn factor at each breakpoint in Reynolds number lookup table

numerical array

The Colburn factor at each breakpoint in the Reynolds number lookup table. The block interpolates between and extrapolates from the breakpoints to obtain the Colburn factor at any Reynolds number. Interpolation is handled by the MATLAB linear estimator and extrapolation is handled by the nearest function.

The Colburn factor must be zero or positive and align from left to right in order of increasing Reynolds number. The number of values in this vector must be equal to the size of the **Reynolds number vector for Colburn factor** parameter to calculate tabulated breakpoints.

Dependencies

To enable this parameter, set **Heat transfer parameterization** to Tabulated data - Colburn factor vs. Reynolds number.

Reynolds number vector for Nusselt number — Reynolds number at each breakpoint in Nusselt number lookup table

numerical array

The Reynolds number at each breakpoint in the Nusselt number lookup table. Either the Reynolds number or the Prandtl number can serve as an independent variable. The block interpolates between and extrapolates from the breakpoints to obtain the Nusselt number at any Reynolds number. Interpolation is handled by the MATLAB linear estimator and extrapolation is handled by the nearest function.

The Reynolds numbers must be greater than zero and increase monotonically from left to right. They can span across laminar, transient, and turbulent regimes. The size of the vector must equal the number of rows in the **Nusselt number table, Nu(Re,Pr)** parameter. If the table has m rows and n columns, the Reynolds number vector must be m elements long.

Dependencies

To enable this parameter, set **Heat transfer parameterization** to Tabulated data - Nusselt number vs. Reynolds number & Prandtl number.

Prandtl number vector for Nusselt number — Prandtl number at each breakpoint in the Nusselt number lookup table

numerical array

Prandtl number at each breakpoint in the Nusselt number lookup table. Either the Prandtl number or the Reynolds number can serve as an independent variable. The block interpolates between and extrapolates from the breakpoints to obtain the Nusselt number at any Prandtl number. Interpolation is handled by the MATLAB linear estimator and extrapolation is handled by the nearest function.

The Prandtl number must be greater than zero and increase monotonically from left to right. They can span across laminar, transient, and turbulent regimes. The size of the vector must equal the number of columns in the **Nusselt number table** parameter. If the table has m rows and n columns, the Prandtl number vector must be n elements long.

Dependencies

To enable this parameter, set **Heat transfer parameterization** to Tabulated data - Nusselt number vs. Reynolds number & Prandtl number.

Nusselt number table, $Nu(Re, Pr)$ — Nusselt number at each breakpoint in Reynolds-Prandtl number lookup table

numerical array

The Nusselt number at each breakpoint in the Reynolds-Prandtl number lookup table. The block interpolates between and extrapolates from the breakpoints to obtain the Nusselt number at any pair of Reynolds and Prandtl numbers. The Nusselt number is required to calculate the heat transfer coefficient.

The Nusselt number must be greater than zero. Each value must align from top to bottom in order of increasing Reynolds number and from left to right in order of increasing Prandtl number. The number of rows must equal the size of the **Reynolds number vector for Nusselt number** parameter, and the number of columns must equal the size of the **Prandtl number vector for Nusselt number** parameter.

Dependencies

To enable this parameter, set **Heat transfer parameterization** to Tabulated data - Nusselt number vs. Reynolds number & Prandtl number.

Threshold mass flow rate for flow reversal — Upper bound of numerically smooth region for mass flow rate

$1e-4$ kg/s (default) | scalar with units of mass per unit time

The mass flow rate below which numerical smoothing is applied. This is employed to avoid discontinuity during flow stagnation. See the Simple Heat Exchanger Interface (G) block for more information about these calculations.

Variables Tab**Pressure of gas volume — Pressure in gas channel at start of simulation**

0.101325 MPa (default) | scalar with units of pressure

Pressure in the gas channel at the start of simulation.

Temperature of gas volume — Temperature in gas channel at start of simulation

293.15 K (default) | scalar with units of temperature

Temperature in the gas channel at the start of simulation

Density of gas volume — Density in gas channel at start of simulation

1.2 kg/m³ (default) | scalar with units of mass over length cubed

Density in the gas channel at the start of simulation

Extended Capabilities

C/C++ Code Generation

Generate C and C++ code using Simulink® Coder™.

See Also

E-NTU Heat Transfer | Heat Exchanger Interface (TL)

Introduced in R2019a

Heat Exchanger (TL)

Heat exchanger for systems with thermal liquid and controlled flows

Library: Simscape / Fluids / Fluid Network Interfaces / Heat Exchangers

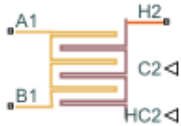

Description

The Heat Exchanger (TL) block models the cooling and heating of fluids through conduction over a thin wall. The properties of a single-phase thermal liquid are defined on the **Thermal Liquid** tab. The second fluid is a controlled fluid, which is specified only by the user-defined parameters on the **Controlled Fluid** tab. It does not receive any properties from the domain fluid network. The heat exchange between the fluids is based on the thermal liquid sensible heat.



Block Variants

Two heat transfer models are available:

- The E-NTU Model
- The Simple Model

To set one of these models, right-click the block and select **Simscape > Block Choices**.

The E-NTU Model Variant

The E-NTU model, based on the Effectiveness-NTU method, is the block default variant. Steady-state heat transfer is determined based on a coefficient relating ideal to real losses in the system:

$$Q_{\text{Act}} = \epsilon Q_{\text{Max}}$$

where

- Q_{Act} the actual heat transfer rate.

- Q_{Max} is the ideal heat transfer rate.
- ε is the heat exchanger effectiveness, which is based on the ratio of heat capacity rates, $\frac{C_{\text{Min}}}{C_{\text{Max}}}$, and the exchanger Number of Transfer Units:

$$NTU = \frac{1}{RC_{\text{Min}}},$$

where R is the overall thermal resistance, which is discussed in “Thermal Resistance” on page 1-903 below. C_{Min} is the lesser heat capacity rate of the two fluids and C_{Max} is the greater heat capacity rate of the two fluids. The heat capacity rate is calculated as $C = c_p \dot{m}$.

Additionally, the exchanger effectiveness depends on the number of passes between the fluids and the fluid mixing conditions. For different parameterizations of ε , see E-NTU Heat Transfer. Connect an E-NTU Heat Transfer block to a Heat Exchanger (TL) block to specify the heat transfer properties in with the E-NTU method.

Flow Arrangement

Use the **Flow arrangement** parameter to define the flow configuration in terms of pipe orientation or effectiveness tables. When using the shell-and-tube configuration, you can select the number of passes in the exchanger. A multi-pass exchanger resembles the image below.

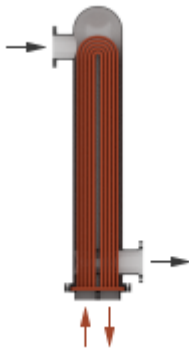

A single-pass exchanger resembles the image below.

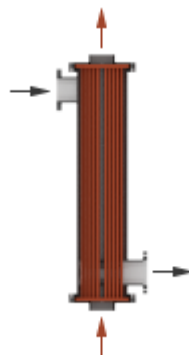

Other flow arrangements are possible through a generic parameterization by tabulated effectiveness data. This table does not require specific heat exchanger configuration details, such as flow arrangement, mixing, and passes, for modeling the heat transfer between the fluids.

Mixing Condition

Use the **Cross flow type** parameter to model flows that are not restricted by baffles or walls, which homogenizes fluid temperature along the direction of flow of the second fluid and varies perpendicular to the second fluid flow. Unmixed flows vary in temperature both along and perpendicular to the flow direction of the second fluid. An example of a heat exchanger with one mixed and one unmixed fluid resembles the configuration below.

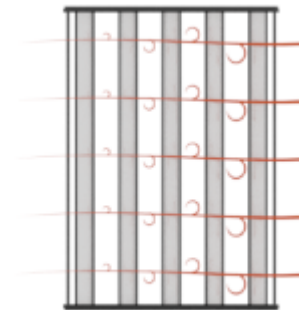

A heat exchanger with two unmixed fluids resembles the configuration below.

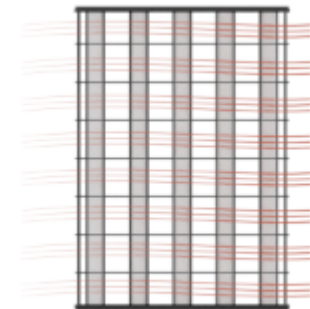

In counter and parallel flow arrangements, longitudinal temperature variation in one fluid results in a longitudinal change in temperature variation in the second fluid and mixing is not taken into account.

Effectiveness Curves

Shell-and-tube exchangers with multiple passes (**iv.b-e** in the figure for 2, 3, and 4 passes) are the most effective type of heat exchanger. For single-pass heat exchangers, the counter-flow configuration (**ii**) is the most effective, and parallel flow (**i**) is the least.

Cross-flow exchangers are intermediate in effectiveness, with mixing condition playing a factor. They are most effective when both flows are unmixed (**iii.a**) and least effective when both flows are mixed (**iii.b**). Mixing just the flow with the smallest heat capacity rate (**iii.c**) lowers the effectiveness more than mixing just the flow with the largest heat capacity rate (**iii.d**).

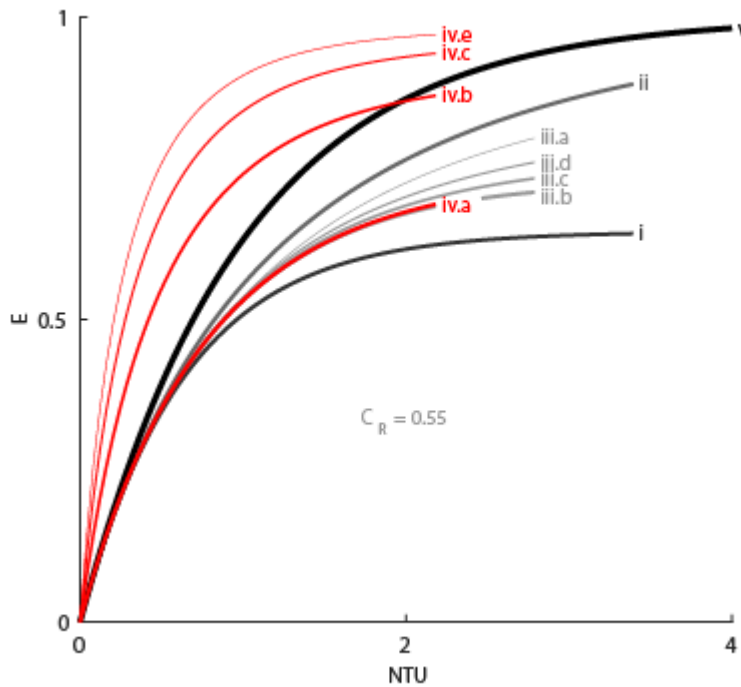

Thermal Resistance

The overall thermal resistance, R , is the sum of the local resistances to heat transfer due to convection, conduction, and fouling along the heat exchanger walls:

$$R = \frac{1}{U_{Th}A_{Th}} + \frac{F_{Th}}{A_{Th}} + R_W + \frac{F_C}{A_C} + \frac{1}{U_C A_C},$$

where:

- U_{Th} is the heat transfer coefficient between the thermal liquid and the wall.
- U_C is the heat transfer coefficient between the controlled fluid and the wall, which is received as a physical signal at port **HC2**.
- F_{Th} is the thermal liquid **Fouling factor**.
- F_C is the controlled fluid **Fouling factor**.
- A_{Th} is the thermal liquid **Heat transfer surface area**.
- A_C is the controlled fluid **Heat transfer surface area**.
- R_W is the **Wall thermal resistance**.

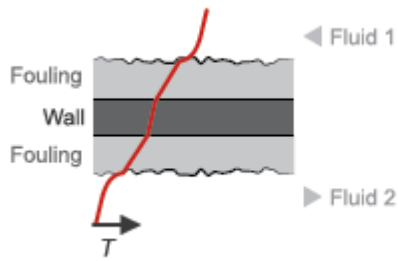

The heat transfer coefficients depend on the heat exchanger configuration and fluid properties. See the E-NTU Heat Transfer reference page for more information.

Composite Structure

When the Heat Exchanger (TL) block employs the E-NTU Model variant, it is a composite of the Heat Exchanger Interface (TL) and E-NTU Heat Transfer blocks:

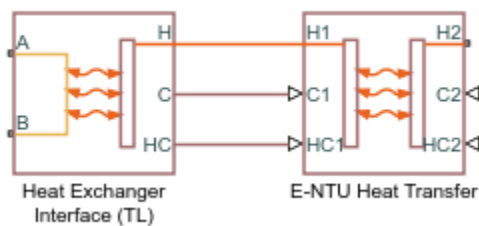

The Simple Model Variant

Heat transfer by the simple model is based on specific dissipation:

$$Q = \xi(T_{In,Th} - T_{In,C}),$$

where:

- ξ is specific dissipation, which is a function of the mass flow rates of the thermal and controlled liquids.
- $T_{In,Th}$ is the thermal liquid inlet temperature.
- $T_{In,C}$ is the controlled liquid inlet temperature.

The simple model is based on linear interpolation of user-provided tabulated data and does not capture individual features of the heat exchanger.

Composite Structure

When the Heat Exchanger (TL) block employs the Simple Model variant, it is a composite of the Simple Heat Exchanger Interface (TL) and Specific Dissipation Heat Transfer blocks:

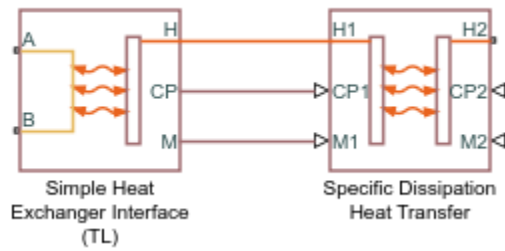

Ports

Conserving

A1 – Thermal liquid port

thermal liquid

Opening for thermal liquid to enter and exit its side of the heat exchanger.

B1 – Thermal liquid port

thermal liquid

Opening for thermal liquid to enter and exit its side of the heat exchanger.

Input

C – Heat capacity rate

physical signal

Instantaneous value of the heat capacity rate for the controlled flow.

Dependencies

This port is active only for the block variant of E-NTU Model.

HC – Heat transfer coefficient

physical signal

Instantaneous value of the heat transfer coefficient between the controlled flow and the wall.

Dependencies

This port is active only for the block variant of E-NTU Model.

CP2 – Isobaric specific heat of controlled fluid

physical signal

Instantaneous value of the isobaric specific heat for the controlled fluid.

Dependencies

This port is active only for the block variant of Simple Model.

M2 – Mass flow rate of controlled fluid

physical signal

Instantaneous value of the mass flow rate of the controlled fluid.

Dependencies

This port is active only for the block variant of Simple Model.

Parameters

Block Variant: Simple Model

Heat Transfer Tab

Thermal liquid mass flow rate vector — Mass flow rate of thermal liquid at each breakpoint in lookup table for specific heat dissipation table

numerical array with units of mass over time

Mass flow rate of thermal liquid at each breakpoint in the lookup table for the specific heat dissipation table. The block inter- and extrapolates the breakpoints to obtain the specific heat dissipation of the heat exchanger at any mass flow rate. Interpolation is the MATLAB `linear` type and extrapolation is `nearest`.

The mass flow rates can be positive, zero, or negative, but they must increase monotonically from left to right. Their number must equal the number of columns in the **Specific heat dissipation table** parameter. If the table has m rows and n columns, the mass flow rate vector must be n elements long.

Controlled fluid mass flow rate vector — Mass flow rate of controlled fluid at each breakpoint in lookup table for specific heat dissipation table

numerical array with units of mass over time

Mass flow rate of controlled fluid at each breakpoint in the lookup table for the specific heat dissipation table. The block inter- and extrapolates the breakpoints to obtain the specific heat dissipation of the heat exchanger at any mass flow rate. Interpolation is the MATLAB `linear` type and extrapolation is `nearest`.

The mass flow rates can be positive, zero, or negative, but they must increase monotonically from left to right. Their number must equal the number of columns in the **Specific heat dissipation table** parameter. If the table has m rows and n columns, the mass flow rate vector must be n elements long.

Specific heat dissipation table — Specific heat dissipation at each breakpoint in lookup table over mass flow rates of thermal liquid and controlled fluid

numerical array with units of power over temperature

Specific heat dissipation at each breakpoint in its lookup table over the mass flow rates of thermal liquid and controlled fluid. The block inter- and extrapolates the breakpoints to obtain the effectiveness at any pair of thermal liquid and controlled fluid mass flow rates. Interpolation is the MATLAB `linear` type and extrapolation is `nearest`.

The specific heat dissipation values must not be negative. They must align from top to bottom in order of increasing mass flow rate in the thermal liquid channel, and from left to right in order of increasing mass flow rate in the controlled fluid channel. The number of rows must equal the size of the **Thermal liquid mass flow rate vector** parameter, and the number of columns must equal the size of the **Controlled fluid mass flow rate vector** parameter.

Check if violating maximum specific dissipation — Warning condition for specific heat dissipation in excess of minimum heat capacity rate

Warning (default) | None

Warning condition for specific heat dissipation in excess of minimum heat capacity rate. Heat capacity rate is the product of mass flow rate and specific heat, and its minimum value is the lowest between the flows. This minimum gives the specific dissipation for a heat exchanger with maximum effectiveness and cannot be exceeded. See the Specific Dissipation Heat Transfer block for more detail.

Pressure Loss Tab**Mass flow rate vector — Mass flow rate at each breakpoint in lookup table for pressure drop**

numerical array with units of mass per unit time

Mass flow rate at each breakpoint in the lookup table for the pressure drop. The block inter- and extrapolates the breakpoints to obtain the pressure drop at any mass flow rate. Interpolation is the MATLAB `linear` type and extrapolation is `nearest`.

The mass flow rates can be positive, zero, or negative and they can span across laminar, transient, and turbulent zones. They must, however, increase monotonically from left to right. Their number must equal the size of the **Pressure drop vector** parameter, with which they are to combine to complete the tabulated breakpoints.

Pressure drop vector — Pressure drop at each breakpoint in lookup table over mass flow rate

numerical array with units of pressure

Pressure drop at each breakpoint in its lookup table over the mass flow rate. The block inter- and extrapolates the breakpoints to obtain the pressure drop at any mass flow rate. Interpolation is the MATLAB `linear` type and extrapolation is `nearest`.

The pressure drops can be positive, zero, or negative, and they can span across laminar, transient, and turbulent zones. They must, however, increase monotonically from left to right. Their number must equal the size of the **Mass flow rate vector** parameter, with which they are to combine to complete the tabulated breakpoints.

Reference inflow temperature — Absolute inlet temperature assumed in tabulated data

293.15 K (default) | scalar with units of temperature

Absolute temperature established at the inlet in the gathering of the tabulated pressure drops. The reference inflow temperature and pressure determine the fluid density assumed in the tabulated data. During simulation, the ratio of reference to actual fluid densities multiplies the tabulated pressure drop to obtain the actual pressure drop.

Reference inflow pressure — Absolute inlet pressure assumed in tabulated data

0.101325 MPa (default) | scalar with units of pressure

Absolute pressure established at the inlet in the gathering of the tabulated pressure drops. The reference inflow temperature and pressure determine the fluid density assumed in the tabulated data. During simulation, the ratio of reference to actual fluid densities multiplies the tabulated pressure drop to obtain the actual pressure drop.

Mass flow rate threshold for flow reversal – Upper bound of numerically smooth region for mass flow rate

1e-3 kg/s (default) | scalar with units of mass/time

Mass flow rate below which its value is numerically smoothed to avoid discontinuities known to produce simulation errors at zero flow. See the Simple Heat Exchanger Interface (TL) block (on which the Simple Model variant is based) for detail on the calculations for the thermal liquid side of the exchanger.

Thermal liquid volume – Volume of fluid in the thermal liquid flow channel

0.01 m³ (default) | scalar with units of length cubed

Volume of fluid in the thermal liquid flow channel.

Cross-sectional area at ports A1 and B1 – Flow area at the inlet and outlet of the flow channel

0.01 m² (default) | scalar with units of length squared

Flow area at the inlet and outlet of the thermal liquid flow channel. The ports are of the same size.

Block Variant: E-NTU Model**Common Tab****Flow arrangement – Manner in which the flows align in the heat exchanger**

Parallel or counter flow (default) | Shell and tube | Cross flow | Generic - effectiveness table

Manner in which the flows align in the heat exchanger. The flows can run parallel to each other, counter to each other, or across each other. They can also run in a pressurized shell, one through tubes enclosed in the shell, the other around those tubes. Other flow arrangements are possible through a generic parameterization based on tabulated effectiveness data and requiring little detail about the heat exchanger.

Number of shell passes – Number of times the flow traverses the shell before exiting

1 (default) | unitless scalar

Number of times the flow traverses the shell before exiting.

Dependencies

This parameter applies solely to the **Flow arrangement** setting of Shell and tube.

Cross flow type – Mixing condition in each of the flow channels

Both fluids mixed (default) | Both fluids unmixed | Thermal liquid mixed & Controlled Fluid unmixed | Thermal liquid unmixed & Controlled Fluid mixed

Mixing condition in each of the flow channels. Mixing in this context is the lateral movement of fluid as it proceeds along its flow channel toward the outlet. The flows remain separate from each other. Unmixed flows are common in channels with plates, baffles, or fins. This setting reflects in the effectiveness of the heat exchanger, with unmixed flows being most effective and mixed flows being least.

Dependencies

This parameter applies solely to the **Flow arrangement** setting of Shell and tube.

Number of heat transfer units vector, NTU — Number of transfer units at each breakpoint in lookup table for heat exchanger effectiveness

unitless numerical array

Number of transfer units at each breakpoint in the lookup table for the heat exchanger effectiveness number. The table is two-way, with both the number of transfer units and the thermal capacity ratio serving as independent coordinates. The block inter- and extrapolates the breakpoints to obtain the effectiveness at any number of transfer units. Interpolation is the MATLAB `linear` type and extrapolation is `nearest`.

The numbers specified must be greater than zero and increase monotonically from left to right. The size of the vector must equal the number of rows in the **Effectiveness table** parameter. If the table has m rows and n columns, the vector for the number of transfer units must be m elements long.

Dependencies

This parameter applies solely to the **Flow arrangement** setting of `Generic - effectiveness table`.

Thermal capacity ratio vector, CR — Thermal capacity ratio at each breakpoint in lookup table for heat exchanger effectiveness

unitless numerical array

Thermal capacity ratio at each breakpoint in lookup table for heat exchanger effectiveness. The table is two-way, with both the number of transfer units and the heat capacity rate ratio serving as independent coordinates. The block inter- and extrapolates the breakpoints to obtain the effectiveness at any thermal capacity ratio. Interpolation is the MATLAB `linear` type and extrapolation is `nearest`.

The thermal capacity ratios must be greater than zero and increase monotonically from left to right. The size of the vector must equal the number of columns in the **Nusselt number table** parameter. If the table has m rows and n columns, the vector for the thermal capacity ratio must be n elements long. The thermal capacity ratio is the fraction of minimum over maximum heat capacity rates.

Dependencies

This parameter applies solely to the **Flow arrangement** setting of `Generic - effectiveness table`.

Effectiveness table, E(NTU, CR) — Heat exchanger effectiveness at each breakpoint in lookup table over the number of transfer units and thermal capacity ratio

unitless numerical array

Heat exchanger effectiveness at each breakpoint in its lookup table over the number of transfer units and thermal capacity ratio. The block inter- and extrapolates the breakpoints to obtain the effectiveness at any pair of number of transfer units and thermal capacity ratio. Interpolation is the MATLAB `linear` type and extrapolation is `nearest`.

The effectiveness values must be not be negative. They must align from top to bottom in order of increasing number of transfer units and from left to right in order of increasing thermal capacity ratio. The number of rows must equal the size of the **Number of heat transfer units vector** parameter, and the number of columns must equal the size of the **Thermal capacity ratio vector** parameter.

Dependencies

This parameter applies solely to the **Flow arrangement** setting of Generic - effectiveness table.

Wall thermal resistance — Resistance of the wall to heat flow by thermal conduction

1.6e-4 K/W (default) | scalar with units of temperature over power

Resistance of the wall to heat flow by thermal conduction, and the inverse of thermal conductance, or the product of thermal conductivity with the ratio of surface area to length. Wall resistance adds to convective and fouling resistances to determine the overall heat transfer coefficient between the flows.

Thermal liquid Tab**Minimum free-flow area — Cross-sectional area of the flow channel at its narrowest point**

0.01 m² (default) | scalar with units of length squared

Cross-sectional area of the flow channel at its narrowest point. If the channel is a collection of ducts, tubes, slots, or grooves, the area is the sum of the areas in the collection—minus the occlusion due to walls, ridges, plates, or other barriers.

Thermal liquid volume — Total volume of fluid in the thermal liquid flow channel

0.01 m³ (default) | scalar with units of length squared

Total volume of fluid contained in the thermal liquid flow channel.

Hydraulic diameter for pressure loss — Effective diameter of the flow channel at its narrowest point

0.1 m (default) | scalar with units of length

Effective inner diameter of the flow at its narrowest point. For channels not circular in cross section, that diameter is of an imaginary circle equal in area to the flow cross section. Its value is the ratio of the minimum free-flow area to a fourth of its gross perimeter.

If the channel is a collection of ducts, tubes, slots, or grooves, the gross perimeter is the sum of the perimeters in the collection. If the channel is a single pipe or tube and it is circular in cross section, the hydraulic diameter is the same as the true diameter.

Laminar flow upper Reynolds number limit — Start of transition between laminar and turbulent zones

2000 (default) | unitless scalar

Start of transition between laminar and turbulent zones. Above this number, inertial forces take hold and the flow grows progressively turbulent. The default value is characteristic of circular pipes and tubes with smooth surfaces.

Turbulent flow lower Reynolds number limit — End of transition between laminar and turbulent zones

4000 (default) | unitless scalar

End of transition between laminar and turbulent zones. Below this number, viscous forces take hold and the flow grows progressively laminar. The default value is characteristic of circular pipes and tubes with smooth surfaces.

Pressure loss parameterization — Mathematical model for pressure loss by viscous friction

constant loss coefficient (default) | correlations for tubes | Tabulated data - Darcy friction factor vs. Reynolds number | Tabulated data - Euler number vs. Reynolds number

Mathematical model for pressure loss by viscous friction. This setting determines which expressions to use for calculation and which block parameters to specify as input. See the Heat Exchanger Interface (TL) block for the calculations by parameterization.

Pressure loss coefficient — Aggregate loss coefficient for all flow resistances between the ports

0.1 (default) | unitless scalar

Aggregate loss coefficient for all flow resistances in the flow channel—including the wall friction responsible for major loss and the local resistances, due to bends, elbows, and other geometry changes, responsible for minor loss.

The loss coefficient is an empirical dimensionless number commonly used to express the pressure loss due to viscous friction. It can be calculated from experimental data or, in some cases, obtained from product data sheets.

Dependencies

This parameter applies solely to the **Pressure loss parameterization** setting of Constant loss coefficient.

Length of flow path from inlet to outlet — Distance traveled from port to port

1 m (default) | unitless scalar with units of length

Total distance the flow must travel to reach across the ports. In multi-pass shell-and-tube exchangers, the total distance is the sum over all shell passes. In tube bundles, corrugated plates, and other channels in which the flow is split into parallel branches, it is the distance covered in a single branch. The longer the flow path, the steeper the major pressure loss due to viscous friction at the wall.

Dependencies

This parameter applies solely to the **Pressure loss parameterization** setting of Correlations for tubes and Tabulated data - Darcy friction factor vs Reynolds number.

Aggregate equivalent length of local resistances — Aggregate minor pressure loss expressed as a length

0.1 m (default) | scalar with units of length

Aggregate minor pressure loss expressed as a length. This length is that which all local resistances, such as elbows, tees, and unions, would add to the flow path if in their place was a simple wall extension. The larger the equivalent length, the steeper the minor pressure loss due to the local resistances.

Dependencies

This parameter applies solely to the **Pressure loss parameterization** setting of Correlations for tubes.

Internal surface absolute roughness – Mean height of surface protrusions behind wall friction

15e-6 m (default) | scalar with units of length

Mean height of the surface protrusions from which wall friction arises. Higher protrusions mean a rougher wall for more friction and so a steeper pressure loss. Surface roughness features in the Haaland correlation from which the Darcy friction factor derives and on which the pressure loss calculation depends.

Dependencies

This parameter applies solely to the **Pressure loss parameterization** setting of Correlations for tubes.

Laminar friction constant for Darcy friction factor – Pressure loss correction for flow cross section in laminar flow conditions

64 (default) | unitless scalar

Pressure loss correction for flow cross section in laminar flow conditions. This parameter is commonly referred to as the shape factor. Its ratio to the Reynolds number gives the Darcy friction factor for the pressure loss calculation in the laminar zone. The default value belongs to cylindrical pipes and tubes.

The shape factor derives for certain shapes from the solution of the Navier-Stokes equations. A square duct has a shape factor of 56, a rectangular duct with aspect ratio of 2:1 has a shape factor of 62, and an annular tube has a shape factor of 96, as does a slender conduit between parallel plates.

Dependencies

This parameter applies solely to the **Pressure loss parameterization** setting of Correlations for tubes.

Reynolds number vector for Darcy friction factor – Reynolds number at each breakpoint in lookup table for Darcy friction factor

unitless numerical array

Reynolds number at each breakpoint in the lookup table for the Darcy friction factor. The block interpolates and extrapolates the breakpoints to obtain the Darcy friction factor at any Reynolds number. Interpolation is the MATLAB `linear` type and extrapolation is `nearest`.

The Reynolds numbers must be greater than zero and increase monotonically from left to right. They can span across laminar, transient, and turbulent zones. Their number must equal the size of the **Darcy friction factor vector** parameter, with which they are to combine to complete the tabulated breakpoints.

Dependencies

This parameter applies solely to the **Pressure loss parameterization** setting of Tabulated data - Darcy friction factor vs. Reynolds number.

Darcy friction factor vector – Darcy friction factor at each breakpoint in lookup table over Reynolds number

unitless numerical array

Darcy friction factor at each breakpoint in its lookup table over the Reynolds number. The block interpolates and extrapolates the breakpoints to obtain the Darcy friction factor at any Reynolds number. Interpolation is the MATLAB `linear` type and extrapolation is `nearest`.

The Darcy friction factors must not be negative and they must align from left to right in order of increasing Reynolds number. Their number must equal the size of the **Reynolds number vector for Darcy friction factor** parameter, with which they are to combine to complete the tabulated breakpoints.

Dependencies

This parameter applies solely to the **Pressure loss parameterization** setting of `Tabulated data - Darcy friction factor vs. Reynolds number`.

Reynolds number vector for Euler number — Reynolds number at each breakpoint in lookup table for Euler number

unitless numerical array

Reynolds number at each breakpoint in the lookup table for the Euler number. The block interpolates and extrapolates the breakpoints to obtain the Euler number at any Reynolds number. Interpolation is the MATLAB `linear` type and extrapolation is `nearest`.

The Reynolds numbers must be greater than zero and increase monotonically from left to right. They can span across laminar, transient, and turbulent zones. Their number must equal the size of the **Euler number vector** parameter, with which they are to combine to complete the tabulated breakpoints.

Dependencies

This parameter applies solely to the **Pressure loss parameterization** setting of `Tabulated data - Euler number vs. Reynolds number`.

Euler number vector — Euler number at each breakpoint in lookup table over Reynolds number

unitless numerical array

Euler number at each breakpoint in its lookup table over the Reynolds number. The block interpolates and extrapolates the breakpoints to obtain the Euler number at any Reynolds number. Interpolation is the MATLAB `linear` type and extrapolation is `nearest`.

The Euler numbers must not be negative and they must align from left to right in order of increasing Reynolds number. Their number must equal the size of the **Reynolds number vector for Euler number** parameter, with which they are to combine to complete the tabulated breakpoints.

Dependencies

This parameter applies solely to the **Pressure loss parameterization** setting of `Tabulated data - Euler number vs. Reynolds number`.

Heat transfer parameterization — Mathematical model for heat transfer between fluid and wall

Constant heat transfer coefficient (default) | Correlations for tubes | Tabulated data - Colburn factor vs. Reynolds number | Tabulated data - Nusselt number vs. Reynolds number & Prandtl number

Mathematical model for heat transfer between fluid and wall. The choice of model determines which expressions to apply and which parameters to specify for heat transfer calculation. See the E-NTU Heat Transfer block for the calculations by parameterization.

Heat transfer surface area – Effective surface area used in heat transfer between fluid and wall

0.4 m² (default) | scalar with units of length squared

Effective surface area used in heat transfer between fluid and wall. The effective surface area is the sum of primary and secondary surface areas, or those of the wall, where it is exposed to fluid, and of the fins, if any are used. Fin surface area is normally scaled by a fin efficiency factor.

Thermal liquid-wall heat transfer coefficient – Heat transfer coefficient for convection between fluid and wall

0.4 m² (default) | unitless scalar

Heat transfer coefficient for convection between fluid and wall. Resistance due to fouling is captured separately in the **Fouling factor** parameter.

Dependencies

This parameter applies solely to the **Heat transfer parameterization** setting of Constant heat transfer coefficient.

Length of flow path for heat transfer – Characteristic length traversed in heat transfer between fluid and wall

1 m (default) | scalar with units of length

Characteristic length traversed in heat transfer between fluid and wall. This length factors in the calculation of the hydraulic diameter from which the heat transfer coefficient and the Reynolds number, as defined in the tabulated heat transfer parameterizations, derives.

Dependencies

This parameter applies solely to the **Heat transfer parameterization** setting of Tabulated data - Colburn factor vs. Reynolds number or Tabulated data - Nusselt number vs. Reynolds number & Prandtl number.

Nusselt number for laminar flow heat transfer – Constant assumed for Nusselt number in laminar flow

3.66 (default) | positive unitless scalar

Constant assumed for Nusselt number in laminar flow. The Nusselt number factors in the calculation of the heat transfer coefficient between fluid and wall, on which the heat transfer rate depends. The default value belongs to cylindrical pipes and tubes.

Dependencies

This parameter applies solely to the **Heat transfer parameterization** setting of Correlations for tubes.

Reynolds number vector for Colburn factor – Values of the Reynolds number at which to specify the Colburn factor data

unitless numerical array

Reynolds number at each breakpoint in the lookup table for the Colburn factor. The block inter- and extrapolates the breakpoints to obtain the Colburn factor at any Reynolds number. Interpolation is the MATLAB `linear` type and extrapolation is nearest.

The Reynolds numbers must be greater than zero and increase monotonically from left to right. They can span across laminar, transient, and turbulent zones. Their number must equal the size of the **Colburn factor vector** parameter, with which they are to combine to complete the tabulated breakpoints.

Dependencies

This parameter applies solely to the **Heat transfer parameterization** setting of Tabulated data - Colburn factor vs. Reynolds number.

Colburn factor vector – Colburn factor at each breakpoint in lookup table over Reynolds number

unitless numerical array

Colburn factor at each breakpoint in its lookup table over the Reynolds number. The block inter- and extrapolates the breakpoints to obtain the Euler number at any Reynolds number. Interpolation is the MATLAB `linear` type and extrapolation is nearest.

The Colburn factors must not be negative and they must align from left to right in order of increasing Reynolds number. Their number must equal the size of the **Reynolds number vector for Colburn factor** parameter, with which they are to combine to complete the tabulated breakpoints.

Dependencies

This parameter applies solely to the **Heat transfer parameterization** setting of Tabulated data - Colburn factor vs. Reynolds number.

Reynolds number vector for Nusselt number – Reynolds number at each breakpoint in lookup table for Nusselt number

unitless numerical array

Reynolds number at each breakpoint in the lookup table for the Nusselt number. The table is two-way, with both Reynolds and Prandtl numbers serving as independent coordinates. The block inter- and extrapolates the breakpoints to obtain the Nusselt number at any Reynolds number. Interpolation is the MATLAB `linear` type and extrapolation is nearest.

The Reynolds numbers must be greater than zero and increase monotonically from left to right. They can span across laminar, transient, and turbulent zones. The size of the vector must equal the number of rows in the **Nusselt number table** parameter. If the table has m rows and n columns, the Reynolds number vector must be m elements long.

Dependencies

This parameter applies solely to the **Heat transfer parameterization** setting of Tabulated data - Nusselt number vs. Reynolds number & Prandtl number.

Prandtl number vector for Nusselt number – Prandtl number at each breakpoint in lookup table for Nusselt number

unitless numerical array

Prandtl number at each breakpoint in the lookup table for the Nusselt number. The table is two-way, with both Reynolds and Prandtl numbers serving as independent coordinates. The block inter- and

extrapolates the breakpoints to obtain the Nusselt number at any Prandtl number. Interpolation is the MATLAB `linear` type and extrapolation is `nearest`.

The Prandtl numbers must be greater than zero and increase monotonically from left to right. They can span across laminar, transient, and turbulent zones. The size of the vector must equal the number of columns in the **Nusselt number table** parameter. If the table has m rows and n columns, the Prandtl number vector must be n elements long.

Dependencies

This parameter applies solely to the **Heat transfer parameterization** setting of `Tabulated data - Nusselt number vs. Reynolds number & Prandtl number`.

Nusselt number table, Nu (Re,Pr) – Nusselt number at each breakpoint in lookup table over Reynolds and Prandtl numbers

unitless numerical array

Nusselt number at each breakpoint in its lookup table over the Reynolds and Prandtl numbers. The block inter- and extrapolates the breakpoints to obtain the Nusselt number at any pair of Reynolds and Prandtl numbers. Interpolation is the MATLAB `linear` type and extrapolation is `nearest`. By determining the Nusselt number, the table feeds the calculation from which the heat transfer coefficient between fluid and wall derives.

The Nusselt numbers must be greater than zero. They must align from top to bottom in order of increasing Reynolds number and from left to right in order of increasing Prandtl numbers. The number of rows must equal the size of the **Reynolds number vector for Nusselt number** parameter, and the number of columns must equal the size of the **Prandtl number vector for Nusselt number** parameter.

Dependencies

This parameter applies solely to the **Heat transfer parameterization** setting of `Tabulated data - Nusselt number vs. Reynolds number & Prandtl number`.

Fouling factor – Measure of thermal resistance due to fouling deposits

$1.6e-4$ K/W (default) | scalar with units of temperature over power

Measure of thermal resistance due to fouling deposits which over time tend to build on the exposed surfaces of the wall. The deposits, as they impose between the fluid and wall a new solid layer through which heat must traverse, add to the heat transfer path an extra thermal resistance. Fouling deposits grow slowly and the resistance due to them is accordingly assumed constant during simulation.

Minimum fluid-wall heat transfer coefficient – Lower bound for the heat transfer coefficient

100 W/(m² * K) (default) | scalar with units of power/area/temperature

Lower bound for the heat transfer coefficient between fluid and wall. If calculation returns a lower heat transfer coefficient, this bound replaces the calculated value.

Controlled Fluid Tab

Heat transfer surface area – Aggregate heat transfer surface area on the controlled fluid side

0.4 m² (default) | scalar with units of length squared

Aggregate heat transfer surface area on the controlled fluid side

Fouling factor — Measure of thermal resistance due to fouling deposits

1e-4 K/W (default) | scalar with units of length squared times temperature over power

Measure of thermal resistance due to fouling deposits which over time tend to build on the exposed surfaces of the wall. The deposits, as they impose between the controlled fluid and wall a new solid layer through which heat must traverse, add to the heat transfer path an extra thermal resistance. Fouling deposits grow slowly and the resistance due to them is accordingly assumed constant during simulation.

Minimum fluid-wall heat transfer coefficient — Lower bound for the heat transfer coefficient

100 W/(m² * K) (default) | scalar with units of power/area/temperature

Lower bound for the heat transfer coefficient between the controlled fluid and wall. If calculation returns a lower heat transfer coefficient, this bound replaces the calculated value.

Effects and Initial Conditions

Thermal liquid initial temperature — Temperature in the thermal liquid channel at the start of simulation

293.15 K (default) | scalar with units of temperature

Temperature in the thermal liquid channel at the start of simulation.

Thermal liquid initial pressure — Pressure in the thermal liquid channel at the start of simulation

0.101325 MPa (default) | scalar with units of pressure

Pressure in the thermal liquid channel at the start of simulation.

Extended Capabilities

C/C++ Code Generation

Generate C and C++ code using Simulink® Coder™.

See Also

E-NTU Heat Transfer | Heat Exchanger Interface (TL) | Specific Dissipation Heat Transfer | Simple Heat Exchanger Interface (TL)

Introduced in R2016a

Heat Exchanger (TL-TL)

Heat exchanger for systems with two thermal liquid flows

Library: Simscape / Fluids / Fluid Network Interfaces / Heat Exchangers



Description

The Heat Exchanger (TL-TL) block models the complementary cooling and heating of fluids held briefly in thermal contact across a thin conductive wall. The wall can store heat in its bounds, adding to the heat transfer a slight transient delay that scales in proportion to its thermal mass. The fluids are single phase—each a thermal liquid. Neither fluid can switch phase and so, as latent heat is never released, the exchange is strictly one of sensible heat.

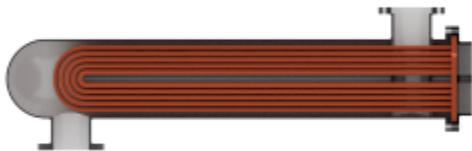

Block Variants

The heat transfer model depends on the choice of block variant. The block has two variants: **E-NTU Model** and **Simple Model**. Right-click the block to open its context-sensitive menu and select **Simscape > Block Choices** to change variant.

E-NTU Model

The default variant. Its heat transfer model derives from the Effectiveness-NTU method. Heat transfer in the steady state then proceeds at a fraction of the ideal rate which the flows, if kept each at its inlet temperature, and if cleared of every thermal resistance in between, could in theory support:

$$Q_{\text{Act}} = \epsilon Q_{\text{Max}}$$

where Q_{Act} the actual heat transfer rate, Q_{Max} is the ideal heat transfer rate, and ϵ is the fraction of the ideal rate actually observed in a real heat exchanger encumbered with losses. The fraction is the heat exchanger effectiveness, and it is a function of the number of transfer units, or NTU, a measure of the ease with which heat moves between flows, relative to the ease with which the flows absorb that heat:

$$NTU = \frac{1}{RC_{\text{Min}}},$$

where the fraction is the overall thermal conductance between the flows and C_{Min} is the smallest of the heat capacity rates from among the flows—that belonging to the flow least capable of absorbing heat. The heat capacity rate of a flow depends on the specific heat of the fluid (c_p) and on its mass flow rate through the exchanger (\dot{m}):

$$C = c_p \dot{m}.$$

The effectiveness depends also on the relative disposition of the flows, the number of passes between them, and the mixing condition for each. This dependence reflects in the effectiveness expression used, with different flow arrangements corresponding to different expressions. For a list of the effectiveness expressions, see the E-NTU Heat Transfer block.

Flow Arrangement

Use the **Flow arrangement** parameter to set how the flows meet in the heat exchanger. The flows can run parallel to each other, counter to each other, or across each other. They can also run in a pressurized shell, one through tubes enclosed in the shell, the other around those same tubes. The figure shows an example. The tube flow can make one pass through the shell flow (shown right) or, for greater exchanger effectiveness, multiple passes (left).

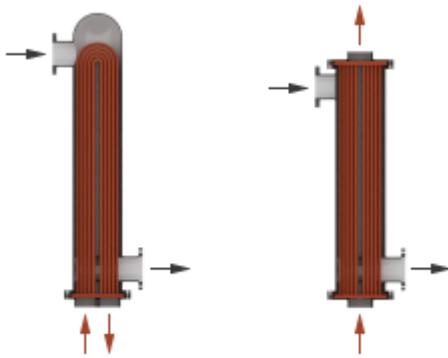

Other flow arrangements are possible through a generic parameterization based on tabulated effectiveness data and requiring little detail about the heat exchanger. Flow arrangement, mixing condition, and number of shell or tube passes, if relevant to the heat exchanger, are assumed to manifest in the tabulated data.

Mixing Condition

Use the **Cross flow type** parameter to mix each of the flows, one of the flows, or none of the flows. Mixing in this context is the lateral movement of fluid in channels that have no internal barriers, normally guides, baffles, fins, or walls. Such movement serves to even out temperature variations in the transverse plane. Mixed flows have variable temperature in the longitudinal plane alone. Unmixed flows have variable temperature in both the transverse and longitudinal planes. The figure shows a mixed flow (**i**) and an unmixed flow (**ii**).

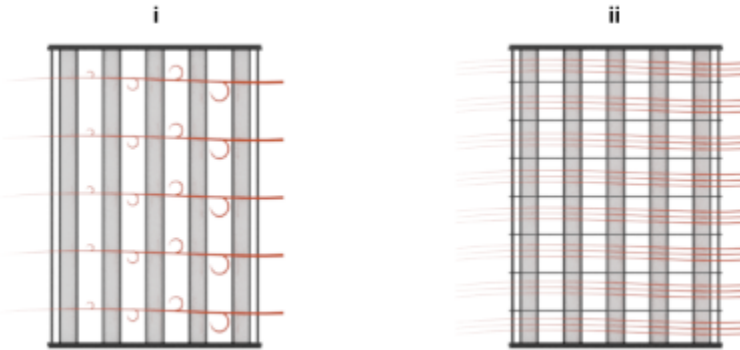

The distinction between mixed and unmixed flows is considered only in cross flow arrangements. There, longitudinal temperature variation in one fluid produces transverse temperature variation in the second fluid that mixing can even out. In counter and parallel flow arrangements, longitudinal temperature variation in one fluid produces longitudinal temperature variation in the second fluid and mixing, as it is of little effect here, is ignored.

Effectiveness Curves

Shell-and-tube exchangers with multiple passes (**iv.b-e** in the figure for 2, 3, and 4 passes) are most effective. Of exchangers with a single pass, those with counter flows (**ii**) are most effective and those with parallel flows (**i**) are least.

Cross-flow exchangers are intermediate in effectiveness, with mixing condition playing a factor. They are most effective when both flows are unmixed (**iii.a**) and least effective when both flows are mixed (**iii.b**). Mixing just the flow with the smallest heat capacity rate (**iii.c**) lowers the effectiveness more than mixing just the flow with the largest heat capacity rate (**iii.d**).

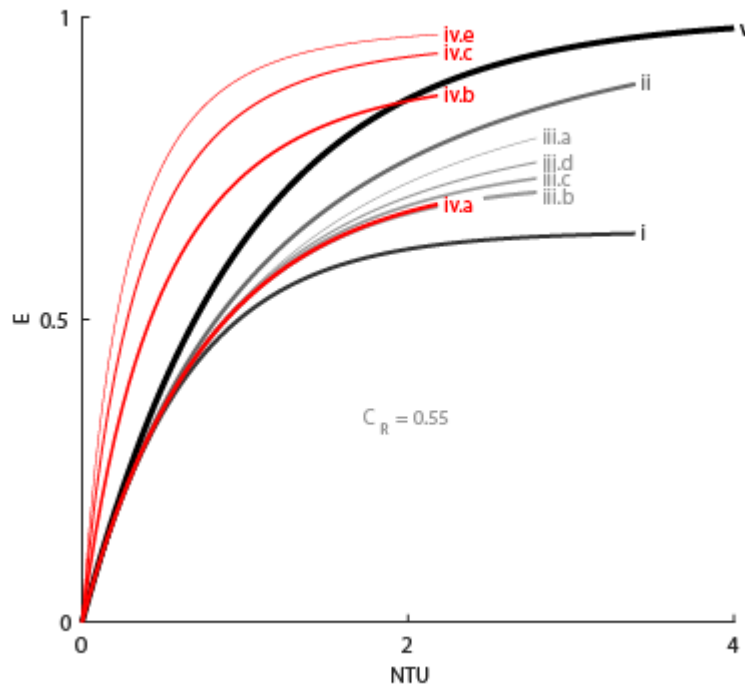

Thermal Resistance

The overall thermal resistance, R , is the sum of the local resistances lining the heat transfer path. The local resistances arise from convection at the surfaces of the wall, conduction through the wall, and, if the wall sides are fouled, conduction through the layers of fouling. Expressed in order from thermal liquid side 1 to thermal liquid side 2:

$$R = \frac{1}{U_1 A_{Th,1}} + \frac{F_1}{A_{Th,1}} + R_{Wall} + \frac{F_2}{A_{Th,2}} + \frac{1}{U_2 A_{Th,2}},$$

where U is the convective heat transfer coefficient, F is the fouling factor, and A_{Th} is the heat transfer surface area, each for the flow indicated in the subscript. R_{Wall} is the thermal resistance of the wall.

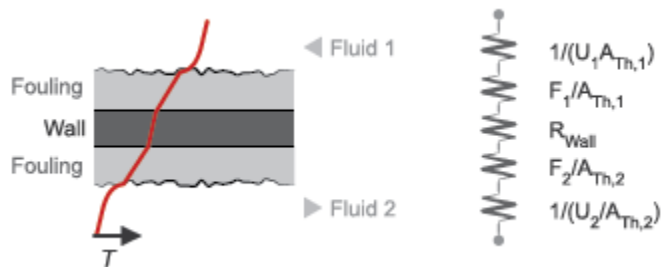

The wall thermal resistance and fouling factors are simple constants obtained from block parameters. The heat transfer coefficients are elaborate functions of fluid properties, flow geometry, and wall friction, and derive from standard empirical correlations between Reynolds, Nusselt, and Prandtl

numbers. The correlations depend on flow arrangement and mixing condition, and are detailed for each in the E-NTU Heat Transfer block on which the E-NTU Model variant is based.

Thermal Mass

The wall is more than a thermal resistance for heat to pass through. It is also a thermal mass and, like the flows it divides, it can store heat in its bounds. The storage slows the transition between steady states so that a thermal perturbation on one side does not promptly manifest on the side across. The lag persists for the short time that it takes the heat flow rates from the two sides to balance each other. That time interval scales with the thermal mass of the wall:

$$C_{Q,W} = c_{p,W}M_W,$$

where $c_{p,W}$ is the specific heat capacity and M_W the inertial mass of the wall. Their product gives the energy required to raise wall temperature by one degree. Use the **Wall thermal mass** parameter to specify that product. The parameter is active when the **Wall thermal dynamics** setting is **On**.

Thermal mass is often negligible in low-pressure systems. Low pressure affords a thin wall with a transient response so fast that, on the time scale of the heat transfer, it is virtually instantaneous. The same is not true of high-pressure systems, common in the production of ammonia by the Haber process, where pressure can break 200 atmospheres. To withstand the high pressure, the wall is often thicker, and, as its thermal mass is heftier, so its transient response is slower.

Set the **Wall thermal dynamics** parameter to **Off** to ignore the transient lag, cut the differential variables that produce it, and, in reducing calculations, speed up the rate of simulation. Leave it **On** to capture the transient lag where it has a measurable effect. Experiment with the setting if necessary to determine whether to account for thermal mass. If simulation results differ to a considerable degree, and if simulation speed is not a factor, keep the setting **On**.

The wall, if modeled with thermal mass, is considered in halves. One half sits on thermal liquid side 1 and the other half sits on thermal liquid side 2. The thermal mass divides evenly between the pair:

$$C_{Q,1} = C_{Q,2} = \frac{C_{Q,W}}{2}.$$

Energy is conserved in the wall. In the simple case of a wall half at steady state, heat gained from the fluid equals heat lost to the second half. The heat flows at the rate predicted by the E-NTU method for a wall without thermal mass. The rate is positive for heat flows directed from side 1 of the heat exchanger to side 2:

$$Q_1 = -Q_2 = \epsilon Q_{\text{Max}}.$$

In the transient state, the wall is in the course of storing or losing heat, and heat gained by one half no longer equals that lost to the second half. The difference in the heat flow rates varies over time in proportion to the rate at which the wall stores or loses heat. For side 1 of the heat exchanger:

$$Q_1 = \epsilon Q_{\text{Max}} + C_{Q,1}\dot{T}_{W,1},$$

where $\dot{T}_{W,1}$ is the rate of change in temperature in the wall half. Its product with the thermal mass of the wall half gives the rate at which heat accumulates there. That rate is positive when temperature rises and negative when it drops. The closer the rate is to zero the closer the wall is to steady state.

For side 2 of the heat exchanger: $Q_2 = -\epsilon Q_{\text{Max}} + C_{Q,2}\dot{T}_{W,2}$,

Composite Structure

The E-NTU Model variant is a composite component built from simpler blocks. A Heat Exchanger Interface (TL) block models the thermal liquid flow on side 1 of the heat exchanger. Another models the thermal liquid flow on side 2. An E-NTU Heat Transfer block models the heat exchanged across the wall between the flows. The figure shows the block connections for the E-NTU Model block variant.

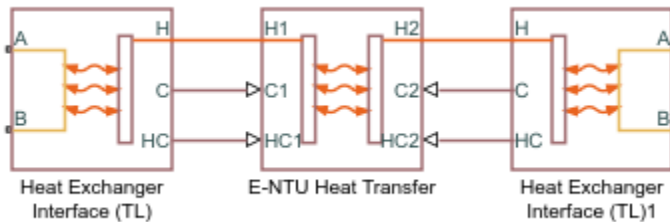

Simple Model

The alternative variant. Its heat transfer model depends on the concept of *specific dissipation*, a measure of the heat transfer rate observed when thermal liquid 1 and thermal liquid 2 inlet temperatures differ by one degree. Its product with the inlet temperature difference gives the expected heat transfer rate:

$$Q = \xi(T_{In,1} - T_{In,2}),$$

where ξ is specific dissipation and T_{in} is inlet temperature for thermal liquid 1 (subscript 1) or thermal liquid 2 (subscript 2). The specific dissipation is a tabulated function of the mass flow rates into the exchanger through the thermal liquid 1 and thermal liquid 2 inlets:

$$\xi = f(\dot{m}_1, \dot{m}_2)$$

To accommodate reverse flows, the tabulated data can extend over positive and negative flow rates, in which case the inlets can also be thought of as outlets. The data normally derives from measurement of heat transfer rate against temperature in a real prototype:

$$\xi = \frac{Q}{T_{In,1} - T_{In,2}}$$

The heat transfer model, as it relies almost entirely on tabulated data, and as that data normally derives from experiment, requires little detail about the exchanger. Flow arrangement, mixing condition, and number of shell or tube passes, if relevant to the heat exchanger modeled, are assumed to manifest entirely in the tabulated data.

See the Specific Dissipation Heat Transfer block for more detail on the heat transfer calculations.

Composite Structure

The Simple Model variant is a composite component. A Simple Heat Exchanger Interface (TL) block models the thermal liquid flow on side 1 of the heat exchanger. Another models the thermal liquid flow on side 2. A Specific Dissipation Heat Transfer block captures the heat exchanged across the wall between the flows.

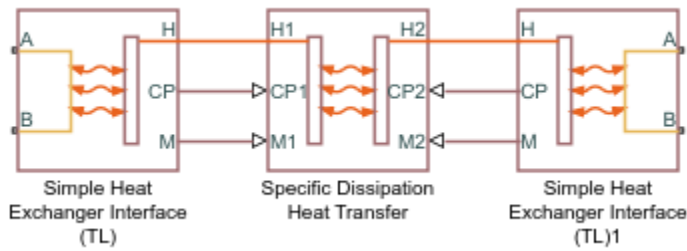

Ports

Conserving

A1 – Thermal liquid 1 port

thermal liquid

Opening for thermal liquid 1 to enter and exit its side of the heat exchanger.

B1 – Thermal liquid 1 port

thermal liquid

Opening for thermal liquid 1 to enter and exit its side of the heat exchanger.

A2 – Thermal liquid 2 port

thermal liquid

Opening for thermal liquid 2 to enter and exit its side of the heat exchanger.

B2 – Thermal liquid 2 port

thermal liquid

Opening for thermal liquid 2 to enter and exit its side of the heat exchanger.

Parameters

Block Variant: Simple Model

Heat Transfer Tab

Thermal Liquid 1 mass flow rate vector – Mass flow rate of thermal liquid 1 at each breakpoint in lookup table for specific heat dissipation table

numerical array with units of mass over time

Mass flow rate of thermal liquid 1 at each breakpoint in the lookup table for the specific heat dissipation table. The block inter- and extrapolates the breakpoints to obtain the specific heat dissipation of the heat exchanger at any mass flow rate. Interpolation is the MATLAB `linear` type and extrapolation is `nearest`.

The mass flow rates can be positive, zero, or negative, but they must increase monotonically from left to right. Their number must equal the number of columns in the **Specific heat dissipation table** parameter. If the table has m rows and n columns, the mass flow rate vector must be n elements long.

Thermal Liquid 2 mass flow rate vector — Mass flow rate of thermal liquid 2 at each breakpoint in lookup table for specific heat dissipation table

numerical array with units of mass over time

Mass flow rate of thermal liquid 2 at each breakpoint in the lookup table for the specific heat dissipation table. The block inter- and extrapolates the breakpoints to obtain the specific heat dissipation of the heat exchanger at any mass flow rate. Interpolation is the MATLAB `linear` type and extrapolation is `nearest`.

The mass flow rates can be positive, zero, or negative, but they must increase monotonically from left to right. Their number must equal the number of columns in the **Specific heat dissipation table** parameter. If the table has m rows and n columns, the mass flow rate vector must be n elements long.

Specific heat dissipation table — Specific heat dissipation at each breakpoint in lookup table over mass flow rates of thermal liquid 1 and thermal liquid 2

numerical array with units of power over temperature

Specific heat dissipation at each breakpoint in its lookup table over the mass flow rates of thermal liquid 1 and thermal liquid 2. The block inter- and extrapolates the breakpoints to obtain the effectiveness at any pair of thermal liquid 1 and thermal liquid 2 mass flow rates. Interpolation is the MATLAB `linear` type and extrapolation is `nearest`.

The specific heat dissipation values must be not be negative. They must align from top to bottom in order of increasing mass flow rate in the thermal liquid 1 channel, and from left to right in order of increasing mass flow rate in the thermal liquid 2 channel. The number of rows must equal the size of the **Thermal liquid 1 mass flow rate vector** parameter, and the number of columns must equal the size of the **Thermal liquid 2 mass flow rate vector** parameter.

Check if violating maximum specific dissipation — Warning condition for specific heat dissipation in excess of minimum heat capacity rate

Warning (default) | None

Warning condition for specific heat dissipation in excess of minimum heat capacity rate. Heat capacity rate is the product of mass flow rate and specific heat, and its minimum value is the lowest between the flows. This minimum gives the specific dissipation for a heat exchanger with maximum effectiveness and cannot be exceeded. See the Specific Dissipation Heat Transfer block for more detail.

Thermal Liquid 1|2 Tab**Mass flow rate vector — Mass flow rate at each breakpoint in lookup table for pressure drop**

numerical array with units of mass per unit time

Mass flow rate at each breakpoint in the lookup table for the pressure drop. The block inter- and extrapolates the breakpoints to obtain the pressure drop at any mass flow rate. Interpolation is the MATLAB `linear` type and extrapolation is `nearest`.

The mass flow rates can be positive, zero, or negative and they can span across laminar, transient, and turbulent zones. They must, however, increase monotonically from left to right. Their number must equal the size of the **Pressure drop vector** parameter, with which they are to combine to complete the tabulated breakpoints.

Pressure drop vector — Pressure drop at each breakpoint in lookup table over mass flow rate

numerical array with units of pressure

Pressure drop at each breakpoint in its lookup table over the mass flow rate. The block inter- and extrapolates the breakpoints to obtain the pressure drop at any mass flow rate. Interpolation is the MATLAB `linear` type and extrapolation is `nearest`.

The pressure drops can be positive, zero, or negative, and they can span across laminar, transient, and turbulent zones. They must, however, increase monotonically from left to right. Their number must equal the size of the **Mass flow rate vector** parameter, with which they are to combine to complete the tabulated breakpoints.

Reference inflow temperature — Absolute inlet temperature assumed in tabulated data

293.15 K (default) | scalar with units of temperature

Absolute temperature established at the inlet in the gathering of the tabulated pressure drops. The reference inflow temperature and pressure determine the fluid density assumed in the tabulated data. During simulation, the ratio of reference to actual fluid densities multiplies the tabulated pressure drop to obtain the actual pressure drop.

Reference inflow pressure — Absolute inlet pressure assumed in tabulated data

0.101325 MPa (default) | scalar with units of pressure

Absolute pressure established at the inlet in the gathering of the tabulated pressure drops. The reference inflow temperature and pressure determine the fluid density assumed in the tabulated data. During simulation, the ratio of reference to actual fluid densities multiplies the tabulated pressure drop to obtain the actual pressure drop.

Threshold mass flow rate for flow reversal — Upper bound of numerically smooth region for mass flow rate

1e-3 kg/s (default) | scalar with units of mass/time

Mass flow rate below which its value is numerically smoothed to avoid discontinuities known to produce simulation errors at zero flow. See the Simple Heat Exchanger Interface (TL) block (on which the Simple Model variant is based) for detail on the calculations.

Fluid volume — Volume of fluid in the thermal liquid 1 or thermal liquid 2 flow channel

0.01 m³ (default) | scalar with units of length cubed

Volume of fluid in the thermal liquid 1 or thermal liquid 2 flow channel.

Cross-sectional area at ports A and B — Flow area at the inlet and outlet of the flow channel

0.01 m² (default) | scalar with units of length squared

Flow area at the inlet and outlet of the thermal liquid 1 or thermal liquid 2 flow channel. Ports in the same flow channel are of the same size.

Block Variant: E-NTU Model**Common Tab****Flow arrangement — Manner in which the flows align in the heat exchanger**

Parallel or counter flow (default) | Shell and tube | Cross flow | Generic - effectiveness table

Manner in which the flows align in the heat exchanger. The flows can run parallel to each other, counter to each other, or across each other. They can also run in a pressurized shell, one through tubes enclosed in the shell, the other around those tubes. Other flow arrangements are possible through a generic parameterization based on tabulated effectiveness data and requiring little detail about the heat exchanger.

Number of shell passes — Number of times the flow traverses the shell before exiting

1 (default) | unitless scalar

Number of times the flow traverses the shell before exiting.

Dependencies

This parameter applies solely to the **Flow arrangement** setting of Shell and tube.

Cross flow type — Mixing condition in each of the flow channels

Both fluids mixed (default) | Both fluids unmixed | Thermal Liquid 1 mixed & Thermal Liquid 2 unmixed | Thermal Liquid 1 unmixed & Thermal Liquid 2 mixed

Mixing condition in each of the flow channels. Mixing in this context is the lateral movement of fluid as it proceeds along its flow channel toward the outlet. The flows remain separate from each other. Unmixed flows are common in channels with plates, baffles, or fins. This setting reflects in the effectiveness of the heat exchanger, with unmixed flows being most effective and mixed flows being least.

Dependencies

This parameter applies solely to the **Flow arrangement** setting of Shell and tube.

Number of heat transfer units vector, NTU — Number of transfer units at each breakpoint in lookup table for heat exchanger effectiveness

unitless numerical array

Number of transfer units at each breakpoint in the lookup table for the heat exchanger effectiveness number. The table is two-way, with both the number of transfer units and the thermal capacity ratio serving as independent coordinates. The block inter- and extrapolates the breakpoints to obtain the effectiveness at any number of transfer units. Interpolation is the MATLAB linear type and extrapolation is nearest.

The numbers specified must be greater than zero and increase monotonically from left to right. The size of the vector must equal the number of rows in the **Effectiveness table** parameter. If the table has m rows and n columns, the vector for the number of transfer units must be m elements long.

Dependencies

This parameter applies solely to the **Flow arrangement** setting of Generic - effectiveness table.

Thermal capacity ratio vector, CR — Thermal capacity ratio at each breakpoint in lookup table for heat exchanger effectiveness

unitless numerical array

Thermal capacity ratio at each breakpoint in lookup table for heat exchanger effectiveness. The table is two-way, with both the number of transfer units and the heat capacity rate ratio serving as independent coordinates. The block inter- and extrapolates the breakpoints to obtain the effectiveness at any thermal capacity ratio. Interpolation is the MATLAB `linear` type and extrapolation is `nearest`.

The thermal capacity ratios must be greater than zero and increase monotonically from left to right. The size of the vector must equal the number of columns in the **Nusselt number table** parameter. If the table has m rows and n columns, the vector for the thermal capacity ratio must be n elements long. The thermal capacity ratio is the fraction of minimum over maximum heat capacity rates.

Dependencies

This parameter applies solely to the **Flow arrangement** setting of `Generic - effectiveness table`.

Effectiveness table, E(NTU,CR) — Heat exchanger effectiveness at each breakpoint in lookup table over the number of transfer units and thermal capacity ratio

unitless numerical array

Heat exchanger effectiveness at each breakpoint in its lookup table over the number of transfer units and thermal capacity ratio. The block inter- and extrapolates the breakpoints to obtain the effectiveness at any pair of number of transfer units and thermal capacity ratio. Interpolation is the MATLAB `linear` type and extrapolation is `nearest`.

The effectiveness values must not be negative. They must align from top to bottom in order of increasing number of transfer units and from left to right in order of increasing thermal capacity ratio. The number of rows must equal the size of the **Number of heat transfer units vector** parameter, and the number of columns must equal the size of the **Thermal capacity ratio vector** parameter.

Dependencies

This parameter applies solely to the **Flow arrangement** setting of `Generic - effectiveness table`.

Wall thermal dynamics — Modeling assumption for transient response of wall to thermal changes

Off (default) | On

Modeling assumption for the transient response of the wall to thermal changes. Set to `On` to impart a thermal mass to the wall and to capture the delay in its transient response to changes in temperature or heat flux. Such delays are relevant in thick walls, such as those required to sustain high pressures. The default setting assumes a wall thin enough for its transient response to be virtually instantaneous on the time scale of the heat transfer.

Wall thermal mass — Heat required to raise wall temperature by one degree

447 J/K (default) | scalar with units of energy over temperature

Heat required to raise wall temperature by one degree. Thermal mass is the product of mass with specific heat and a measure of the ability to absorb heat. A wall with thermal mass has a transient

response to sudden changes in surface temperature or heat flux. The larger the thermal mass, the slower that response, and the longer the time to steady state. The default value corresponds to a wall of stainless steel with a mass of approximately 1 kg.

Dependencies

This parameter applies solely to the **Wall thermal dynamics** setting of On.

Wall thermal resistance — Resistance of the wall to heat flow by thermal conduction

1.6e-4 K/W (default) | scalar with units of temperature over power

Resistance of the wall to heat flow by thermal conduction, and the inverse of thermal conductance, or the product of thermal conductivity with the ratio of surface area to length. Wall resistance adds to convective and fouling resistances to determine the overall heat transfer coefficient between the flows.

Thermal Liquid 1|2 Tab

Minimum free-flow area — Cross-sectional area of the flow channel at its narrowest point

0.01 m² (default) | scalar with units of length squared

Cross-sectional area of the flow channel at its narrowest point. If the channel is a collection of ducts, tubes, slots, or grooves, the area is the sum of the areas in the collection—minus the occlusion due to walls, ridges, plates, or other barriers.

Fluid volume — Total volume of fluid in the thermal liquid 1 or thermal liquid 2 flow channel

0.01 m³ (default) | scalar with units of length squared

Total volume of fluid contained in the thermal liquid 1 or thermal liquid 2 flow channel.

Hydraulic diameter for pressure loss — Effective diameter of the flow channel at its narrowest point

0.1 m (default) | scalar with units of length

Effective inner diameter of the flow at its narrowest point. For channels not circular in cross section, that diameter is of an imaginary circle equal in area to the flow cross section. Its value is the ratio of the minimum free-flow area to a fourth of its gross perimeter.

If the channel is a collection of ducts, tubes, slots, or grooves, the gross perimeter is the sum of the perimeters in the collection. If the channel is a single pipe or tube and it is circular in cross section, the hydraulic diameter is the same as the true diameter.

Laminar flow upper Reynolds number limit — Start of transition between laminar and turbulent zones

2000 (default) | unitless scalar

Start of transition between laminar and turbulent zones. Above this number, inertial forces take hold and the flow grows progressively turbulent. The default value is characteristic of circular pipes and tubes with smooth surfaces.

Turbulent flow lower Reynolds number limit — End of transition between laminar and turbulent zones

4000 (default) | unitless scalar

End of transition between laminar and turbulent zones. Below this number, viscous forces take hold and the flow grows progressively laminar. The default value is characteristic of circular pipes and tubes with smooth surfaces.

Pressure loss parameterization — Mathematical model for pressure loss by viscous friction

constant loss coefficient (default) | correlations for tubes | Tabulated data - Darcy friction factor vs. Reynolds number | Tabulated data - Euler number vs. Reynolds number

Mathematical model for pressure loss by viscous friction. This setting determines which expressions to use for calculation and which block parameters to specify as input. See the Heat Exchanger Interface (TL) block for the calculations by parameterization.

Pressure loss coefficient — Aggregate loss coefficient for all flow resistances between the ports

0.1 (default) | unitless scalar

Aggregate loss coefficient for all flow resistances in the flow channel—including the wall friction responsible for major loss and the local resistances, due to bends, elbows, and other geometry changes, responsible for minor loss.

The loss coefficient is an empirical dimensionless number commonly used to express the pressure loss due to viscous friction. It can be calculated from experimental data or, in some cases, obtained from product data sheets.

Dependencies

This parameter applies solely to the **Pressure loss parameterization** setting of Constant loss coefficient.

Length of flow path from inlet to outlet — Distance traveled from port to port

1 m (default) | unitless scalar with units of length

Total distance the flow must travel to reach across the ports. In multi-pass shell-and-tube exchangers, the total distance is the sum over all shell passes. In tube bundles, corrugated plates, and other channels in which the flow is split into parallel branches, it is the distance covered in a single branch. The longer the flow path, the steeper the major pressure loss due to viscous friction at the wall.

Dependencies

This parameter applies solely to the **Pressure loss parameterization** setting of Correlations for tubes and Tabulated data - Darcy friction factor vs Reynolds number.

Aggregate equivalent length of local resistances — Aggregate minor pressure loss expressed as a length

0.1 m (default) | scalar with units of length

Aggregate minor pressure loss expressed as a length. This length is that which all local resistances, such as elbows, tees, and unions, would add to the flow path if in their place was a simple wall extension. The larger the equivalent length, the steeper the minor pressure loss due to the local resistances.

Dependencies

This parameter applies solely to the **Pressure loss parameterization** setting of Correlations for tubes.

Internal surface absolute roughness — Mean height of surface protrusions behind wall friction

15e-6 m (default) | scalar with units of length

Mean height of the surface protrusions from which wall friction arises. Higher protrusions mean a rougher wall for more friction and so a steeper pressure loss. Surface roughness features in the Haaland correlation from which the Darcy friction factor derives and on which the pressure loss calculation depends.

Dependencies

This parameter applies solely to the **Pressure loss parameterization** setting of Correlations for tubes.

Laminar friction constant for Darcy friction factor — Pressure loss correction for flow cross section in laminar flow conditions

64 (default) | unitless scalar

Pressure loss correction for flow cross section in laminar flow conditions. This parameter is commonly referred to as the shape factor. Its ratio to the Reynolds number gives the Darcy friction factor for the pressure loss calculation in the laminar zone. The default value belongs to cylindrical pipes and tubes.

The shape factor derives for certain shapes from the solution of the Navier-Stokes equations. A square duct has a shape factor of 56, a rectangular duct with aspect ratio of 2:1 has a shape factor of 62, and an annular tube has a shape factor of 96, as does a slender conduit between parallel plates.

Dependencies

This parameter applies solely to the **Pressure loss parameterization** setting of Correlations for tubes.

Reynolds number vector for Darcy friction factor — Reynolds number at each breakpoint in lookup table for Darcy friction factor

unitless numerical array

Reynolds number at each breakpoint in the lookup table for the Darcy friction factor. The block interpolates the breakpoints to obtain the Darcy friction factor at any Reynolds number. Interpolation is the MATLAB `linear` type and extrapolation is `nearest`.

The Reynolds numbers must be greater than zero and increase monotonically from left to right. They can span across laminar, transient, and turbulent zones. Their number must equal the size of the **Darcy friction factor vector** parameter, with which they are to combine to complete the tabulated breakpoints.

Dependencies

This parameter applies solely to the **Pressure loss parameterization** setting of Tabulated data - Darcy friction factor vs. Reynolds number.

Darcy friction factor vector – Darcy friction factor at each breakpoint in lookup table over Reynolds number

unitless numerical array

Darcy friction factor at each breakpoint in its lookup table over the Reynolds number. The block interpolates and extrapolates the breakpoints to obtain the Darcy friction factor at any Reynolds number. Interpolation is the MATLAB `linear` type and extrapolation is `nearest`.

The Darcy friction factors must not be negative and they must align from left to right in order of increasing Reynolds number. Their number must equal the size of the **Reynolds number vector for Darcy friction factor** parameter, with which they are to combine to complete the tabulated breakpoints.

Dependencies

This parameter applies solely to the **Pressure loss parameterization** setting of `Tabulated data - Darcy friction factor vs. Reynolds number`.

Reynolds number vector for Euler number – Reynolds number at each breakpoint in lookup table for Euler number

unitless numerical array

Reynolds number at each breakpoint in the lookup table for the Euler number. The block interpolates and extrapolates the breakpoints to obtain the Euler number at any Reynolds number. Interpolation is the MATLAB `linear` type and extrapolation is `nearest`.

The Reynolds numbers must be greater than zero and increase monotonically from left to right. They can span across laminar, transient, and turbulent zones. Their number must equal the size of the **Euler number vector** parameter, with which they are to combine to complete the tabulated breakpoints.

Dependencies

This parameter applies solely to the **Pressure loss parameterization** setting of `Tabulated data - Euler number vs. Reynolds number`.

Euler number vector – Euler number at each breakpoint in lookup table over Reynolds number

unitless numerical array

Euler number at each breakpoint in its lookup table over the Reynolds number. The block interpolates and extrapolates the breakpoints to obtain the Euler number at any Reynolds number. Interpolation is the MATLAB `linear` type and extrapolation is `nearest`.

The Euler numbers must not be negative and they must align from left to right in order of increasing Reynolds number. Their number must equal the size of the **Reynolds number vector for Euler number** parameter, with which they are to combine to complete the tabulated breakpoints.

Dependencies

This parameter applies solely to the **Pressure loss parameterization** setting of `Tabulated data - Euler number vs. Reynolds number`.

Heat transfer parameterization – Mathematical model for heat transfer between fluid and wall

Constant heat transfer coefficient (default) | Correlations for tubes | Tabulated data - Colburn factor vs. Reynolds number | Tabulated data - Nusselt number vs. Reynolds number & Prandtl number

Mathematical model for heat transfer between fluid and wall. The choice of model determines which expressions to apply and which parameters to specify for heat transfer calculation. See the E-NTU Heat Transfer block for the calculations by parameterization.

Heat transfer surface area – Effective surface area used in heat transfer between fluid and wall

0.4 m² (default) | scalar with units of length squared

Effective surface area used in heat transfer between fluid and wall. The effective surface area is the sum of primary and secondary surface areas, or those of the wall, where it is exposed to fluid, and of the fins, if any are used. Fin surface area is normally scaled by a fin efficiency factor.

Liquid-wall heat transfer coefficient – Heat transfer coefficient for convection between fluid and wall

0.4 m² (default) | unitless scalar

Heat transfer coefficient for convection between fluid and wall. Resistance due to fouling is captured separately in the **Fouling factor** parameter.

Dependencies

This parameter applies solely to the **Heat transfer parameterization** setting of Constant heat transfer coefficient.

Length of flow path for heat transfer – Characteristic length traversed in heat transfer between fluid and wall

1 m (default) | scalar with units of length

Characteristic length traversed in heat transfer between fluid and wall. This length factors in the calculation of the hydraulic diameter from which the heat transfer coefficient and the Reynolds number, as defined in the tabulated heat transfer parameterizations, derives.

Dependencies

This parameter applies solely to the **Heat transfer parameterization** setting of Tabulated data - Colburn factor vs. Reynolds number or Tabulated data - Nusselt number vs. Reynolds number & Prandtl number.

Nusselt number for laminar flow heat transfer – Constant assumed for Nusselt number in laminar flow

3.66 (default) | positive unitless scalar

Constant assumed for Nusselt number in laminar flow. The Nusselt number factors in the calculation of the heat transfer coefficient between fluid and wall, on which the heat transfer rate depends. The default value belongs to cylindrical pipes and tubes.

Dependencies

This parameter applies solely to the **Heat transfer parameterization** setting of Correlations for tubes.

Reynolds number vector for Colburn factor — Values of the Reynolds number at which to specify the Colburn factor data

unitless numerical array

Reynolds number at each breakpoint in the lookup table for the Colburn factor. The block inter- and extrapolates the breakpoints to obtain the Colburn factor at any Reynolds number. Interpolation is the MATLAB `linear` type and extrapolation is `nearest`.

The Reynolds numbers must be greater than zero and increase monotonically from left to right. They can span across laminar, transient, and turbulent zones. Their number must equal the size of the **Colburn factor vector** parameter, with which they are to combine to complete the tabulated breakpoints.

Dependencies

This parameter applies solely to the **Heat transfer parameterization** setting of `Tabulated data - Colburn factor vs. Reynolds number`.

Colburn factor vector — Colburn factor at each breakpoint in lookup table over Reynolds number

unitless numerical array

Colburn factor at each breakpoint in its lookup table over the Reynolds number. The block inter- and extrapolates the breakpoints to obtain the Euler number at any Reynolds number. Interpolation is the MATLAB `linear` type and extrapolation is `nearest`.

The Colburn factors must not be negative and they must align from left to right in order of increasing Reynolds number. Their number must equal the size of the **Reynolds number vector for Colburn factor** parameter, with which they are to combine to complete the tabulated breakpoints.

Dependencies

This parameter applies solely to the **Heat transfer parameterization** setting of `Tabulated data - Colburn factor vs. Reynolds number`.

Reynolds number vector for Nusselt number — Reynolds number at each breakpoint in lookup table for Nusselt number

unitless numerical array

Reynolds number at each breakpoint in the lookup table for the Nusselt number. The table is two-way, with both Reynolds and Prandtl numbers serving as independent coordinates. The block inter- and extrapolates the breakpoints to obtain the Nusselt number at any Reynolds number. Interpolation is the MATLAB `linear` type and extrapolation is `nearest`.

The Reynolds numbers must be greater than zero and increase monotonically from left to right. They can span across laminar, transient, and turbulent zones. The size of the vector must equal the number of rows in the **Nusselt number table** parameter. If the table has m rows and n columns, the Reynolds number vector must be m elements long.

Dependencies

This parameter applies solely to the **Heat transfer parameterization** setting of `Tabulated data - Nusselt number vs. Reynolds number & Prandtl number`.

Prandtl number vector for Nusselt number — Prandtl number at each breakpoint in lookup table for Nusselt number

unitless numerical array

Prandtl number at each breakpoint in the lookup table for the Nusselt number. The table is two-way, with both Reynolds and Prandtl numbers serving as independent coordinates. The block inter- and extrapolates the breakpoints to obtain the Nusselt number at any Prandtl number. Interpolation is the MATLAB `linear` type and extrapolation is `nearest`.

The Prandtl numbers must be greater than zero and increase monotonically from left to right. They can span across laminar, transient, and turbulent zones. The size of the vector must equal the number of columns in the **Nusselt number table** parameter. If the table has m rows and n columns, the Prandtl number vector must be n elements long.

Dependencies

This parameter applies solely to the **Heat transfer parameterization** setting of Tabulated data - Nusselt number vs. Reynolds number & Prandtl number.

Nusselt number table, Nu (Re,Pr) — Nusselt number at each breakpoint in lookup table over Reynolds and Prandtl numbers

unitless numerical array

Nusselt number at each breakpoint in its lookup table over the Reynolds and Prandtl numbers. The block inter- and extrapolates the breakpoints to obtain the Nusselt number at any pair of Reynolds and Prandtl numbers. Interpolation is the MATLAB `linear` type and extrapolation is `nearest`. By determining the Nusselt number, the table feeds the calculation from which the heat transfer coefficient between fluid and wall derives.

The Nusselt numbers must be greater than zero. They must align from top to bottom in order of increasing Reynolds number and from left to right in order of increasing Prandtl numbers. The number of rows must equal the size of the **Reynolds number vector for Nusselt number** parameter, and the number of columns must equal the size of the **Prandtl number vector for Nusselt number** parameter.

Dependencies

This parameter applies solely to the **Heat transfer parameterization** setting of Tabulated data - Nusselt number vs. Reynolds number & Prandtl number.

Fouling factor — Measure of thermal resistance due to fouling deposits

1.6e-4 K/W (default) | scalar with units of temperature over power

Measure of thermal resistance due to fouling deposits which over time tend to build on the exposed surfaces of the wall. The deposits, as they impose between the fluid and wall a new solid layer through which heat must traverse, add to the heat transfer path an extra thermal resistance. Fouling deposits grow slowly and the resistance due to them is accordingly assumed constant during simulation.

Minimum fluid-wall heat transfer coefficient — Lower bound for the heat transfer coefficient100 W/(m² * K) (default) | scalar with units of power/area/temperature

Lower bound for the heat transfer coefficient between fluid and wall. If calculation returns a lower heat transfer coefficient, this bound replaces the calculated value.

Effects and Initial Conditions

Thermal liquid dynamic compressibility – Option to model pressure dynamics in the thermal liquid channel

On (default) | Off

Option to model the pressure dynamics in the thermal liquid 1 or thermal liquid 2 channel. Setting this parameter to Off removes the pressure derivative terms from the component energy and mass conservation equations. The pressure inside the heat exchanger is then reduced to the weighted average of the two port pressures.

Thermal Liquid initial temperature – Temperature in the thermal liquid 1 or thermal liquid 2 channel at the start of simulation

293.15 K (default) | scalar with units of temperature

Temperature in the thermal liquid 1 or thermal liquid 2 channel at the start of simulation.

Thermal Liquid 1|2 initial pressure – Pressure in the thermal liquid 1 or thermal liquid 2 channel at the start of simulation

0.101325 MPa (default) | scalar with units of pressure

Pressure in the thermal liquid 1 or thermal liquid 2 channel at the start of simulation.

Extended Capabilities

C/C++ Code Generation

Generate C and C++ code using Simulink® Coder™.

See Also

E-NTU Heat Transfer | Heat Exchanger Interface (TL) | Specific Dissipation Heat Transfer | Simple Heat Exchanger Interface (TL)

Introduced in R2016a

Heat Exchanger Interface (TL)

Thermal interface between a thermal liquid and its surroundings

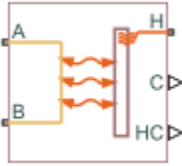

Library

Fluid Network Interfaces/Heat Exchangers/Fundamental Components

Description

The Heat Exchanger Interface (TL) block models the pressure drop and temperature change between the thermal liquid inlet and outlet of a thermal interface. Combine with the E-NTU Heat Transfer block to model the heat transfer rate across the interface between two fluids.

Mass Balance

The form of the mass balance equation depends on the dynamic compressibility setting. If the **Fluid dynamic compressibility** parameter is set to Off, the mass balance equation is

$$\dot{m}_A + \dot{m}_B = 0,$$

where:

- \dot{m}_A and \dot{m}_B are the mass flow rates into the interface through ports A and B.

If the **Fluid dynamic compressibility** parameter is set to On, the mass balance equation is

$$\dot{m}_A + \dot{m}_B = \left(\frac{dp}{dt} \frac{1}{\beta} - \frac{dT}{dt} \alpha \right) \rho V,$$

where:

- p is the pressure of the thermal liquid volume.
- T is the temperature of the thermal liquid volume.
- α is the isobaric thermal expansion coefficient of the thermal liquid volume.
- β is the isothermal bulk modulus of the thermal liquid volume.
- ρ is the mass density of the thermal liquid volume.
- V is the volume of thermal liquid in the heat exchanger interface.

Momentum Balance

The momentum balance in the heat exchanger interface depends on the fluid dynamic compressibility setting. If the **Fluid dynamic compressibility** parameter is set to On, the momentum balance

factors in the internal pressure of the heat exchanger interface explicitly. The momentum balance in the half volume between port A and the internal interface node is computed as

$$p_A - p = \Delta p_{Loss,A},$$

while in the half volume between port B and the internal interface node it is computed as

$$p_B - p = \Delta p_{Loss,B},$$

where:

- p_A and p_B are the pressures at ports A and B.
- p is the pressure in the internal node of the interface volume.
- $\Delta p_{Loss,A}$ and $\Delta p_{Loss,B}$ are the pressure losses between port A and the internal interface node and between port B and the internal interface node.

If the **Fluid dynamic compressibility** parameter is set to **Off**, the momentum balance in the interface volume is computed directly between ports A and B as

$$p_A - p_B = \Delta p_{Loss,A} - \Delta p_{Loss,B}.$$

Pressure Loss Calculations

The exact form of the pressure loss terms depends on the **Pressure loss parameterization** setting in the block dialog box. If the pressure loss parameterization is set to **Constant loss coefficient**, the pressure loss in the half volume adjacent to port A is

$$\Delta p_{Loss,A} = \begin{cases} \dot{m}_A \mu_A (CP)_{Loss} Re_L \frac{1}{4D_{h,p} \rho_A S_{Min}}, & Re_A \leq Re_L \\ (CP)_{Loss} \frac{\dot{m}_A |\dot{m}_A|}{4\rho_A S_{Min}^2}, & Re_A \geq Re_T \end{cases},$$

while in the half volume adjacent to port B it is

$$\Delta p_{Loss,B} = \begin{cases} \dot{m}_B \mu_B (CP)_{Loss} Re_L \frac{1}{4D_{h,p} \rho_B S_{Min}}, & Re_B \leq Re_L \\ (CP)_{Loss} \frac{\dot{m}_B |\dot{m}_B|}{4\rho_B S_{Min}^2}, & Re_B \geq Re_T \end{cases},$$

where:

- μ_A and μ_B are the fluid dynamic viscosities at ports A and B.
- CP_{Loss} is the **Pressure loss coefficient** parameter specified in the block dialog box.
- Re_L is the Reynolds number upper bound for the laminar flow regime.
- Re_T is the Reynolds number lower bound for the turbulent flow regime.
- $D_{h,p}$ is the hydraulic diameter for pressure loss calculations.
- ρ_A and ρ_B are the fluid mass densities at ports A and B.
- S_{Min} is the total minimum free-flow area.

If the pressure loss parameterization is set to **Correlations for tubes**, the pressure loss in the half volume adjacent to port A is

$$\Delta p_{Loss,A} = \begin{cases} \dot{m}_A \mu_A \lambda \frac{(L_{press} + L_{add})}{4D_{h,p} \rho_A S_{Min}}, & Re_A \leq Re_L \\ f_{T,A} \frac{(L_{press} + L_{add})}{4D_{h,p}} \frac{\dot{m}_A |\dot{m}_A|}{\rho_A S_{Min}^2}, & Re_A \geq Re_T \end{cases},$$

while in the half volume adjacent to port B it is

$$\Delta p_{Loss,B} = \begin{cases} \dot{m}_B \mu_B \lambda \frac{(L_{press} + L_{add})}{4D_{h,p} \rho_B S_{Min}}, & Re_B \leq Re_L \\ f_{T,B} \frac{(L_{press} + L_{add})}{4D_{h,p}} \frac{\dot{m}_B |\dot{m}_B|}{\rho_B S_{Min}^2}, & Re_B \geq Re_T \end{cases},$$

where:

- L_{press} is the flow path length from inlet to outlet.
- L_{add} is the aggregate equivalent length of local resistances.
- $f_{T,A}$ and $f_{T,B}$ are the turbulent-regime Darcy friction factors at ports A and B.

The Darcy friction factor in the half volume adjacent to port A is

$$f_{T,A} = \frac{1}{\left[-1.8 \log_{10} \left(\frac{6.9}{Re_A} + \frac{r}{3.7D_{h,p}} \right)^{1.11} \right]^2},$$

while in the half volume adjacent to port B it is

$$f_{T,B} = \frac{1}{\left[-1.8 \log_{10} \left(\frac{6.9}{Re_B} + \frac{r}{3.7D_{h,p}} \right)^{1.11} \right]^2},$$

where:

- r is the internal surface absolute roughness.

If the pressure loss parameterization is set to **Tabulated data – Darcy friction factor vs. Reynolds number**, the pressure loss in the half volume adjacent to port A is

$$\Delta p_{Loss,A} = \begin{cases} \dot{m}_A \mu_A \lambda \frac{L_{press}}{4D_{h,p}^2 \rho_A S_{Min}}, & Re_A \leq Re_L \\ f(Re_A) \frac{L_{press}}{4D_{h,p}} \frac{\dot{m}_A |\dot{m}_A|}{\rho_A S_{Min}^2}, & Re_A \geq Re_T \end{cases},$$

while in the half volume adjacent to port B it is

$$\Delta p_{Loss,B} = \begin{cases} \dot{m}_B \mu_B \lambda \frac{L_{press}}{4D_{h,p}^2 \rho_B S_{Min}}, & Re_B \leq Re_L \\ f(Re_B) \frac{L_{press}}{4D_{h,p}} \frac{\dot{m}_B |\dot{m}_B|}{\rho_B S_{Min}^2}, & Re_B \geq Re_T \end{cases},$$

where:

- λ is the shape factor for laminar flow viscous friction.
- $f(Re_A)$ and $f(Re_B)$ are the Darcy friction factors at ports A and B. The block obtains the friction factors from tabulated data specified relative to the Reynolds number.

If the pressure loss parameterization is set to **Tabulated data – Euler number vs. Reynolds number**, the pressure loss in the half volume adjacent to port A is

$$\Delta p_{Loss, A} = \begin{cases} \dot{m}_A \mu_A Eu(Re_L) Re_L \frac{1}{4D_{h,p} \rho_A S_{Min}}, & Re_A \leq Re_L \\ Eu(Re_A) \frac{\dot{m}_A |\dot{m}_A|}{4\rho_A S_{Min}^2}, & Re_A \geq Re_T \end{cases}$$

while in the half volume adjacent to port B it is

$$\Delta p_{Loss, B} = \begin{cases} \dot{m}_B \mu_B Eu(Re_L) Re_L \frac{1}{4D_{h,p} \rho_B S_{Min}}, & Re_B \leq Re_L \\ Eu(Re_B) \frac{\dot{m}_B |\dot{m}_B|}{4\rho_B S_{Min}^2}, & Re_B \geq Re_T \end{cases}$$

where:

- $Eu(Re_L)$ is the Euler number at the Reynolds number upper bound for laminar flows.
- $Eu(Re_A)$ and $Eu(Re_B)$ are the Euler numbers at ports A and B. The block obtains the Euler numbers from tabulated data specified relative to the Reynolds number.

Energy Balance

The energy balance in the heat exchanger interface depends on the fluid dynamic compressibility setting. If the **Fluid dynamic compressibility** parameter is set to **On**, the energy balance is

$$\frac{dp}{dt} \frac{dU}{dp} + \frac{dT}{dt} \frac{dU}{dT} = \Phi_A + \Phi_B + Q_H,$$

where:

- U is the internal energy contained in the volume of the heat exchanger interface.
- Φ_A and Φ_B are the energy flow rates through ports **A** and **B** into the volume of the heat exchanger interface.
- Q_H is the heat flow rate through port **H**, representing the interface wall, into the volume of the heat exchange interface.

The internal energy derivatives are defined as

$$\frac{dU}{dp} = \left[\frac{1}{\beta} (\rho u + p) - T\alpha \right] V$$

and

$$\frac{dU}{dT} = \left[c_p - \alpha \left(u + \frac{p}{\rho} \right) \right] \rho V,$$

where u is the specific internal energy of the thermal liquid, or the internal energy contained in a unit mass of the same.

If the **Fluid dynamic compressibility** parameter is set to **Off**, the thermal liquid density is treated as a constant. The bulk modulus is then effectively infinite and the thermal expansion coefficient zero. The pressure and temperature derivatives of the compressible case vanish and the energy balance is restated as

$$\frac{dE}{dt} = \phi_A + \phi_B + Q_H,$$

where E is the total internal energy of the incompressible thermal liquid, or

$$E = \rho u V.$$

Heat Transfer Correlations

The block calculates and outputs the liquid-wall heat transfer coefficient value. The calculation depends on the **Heat transfer coefficient specification** setting in the block dialog box. If the heat transfer coefficient specification is **Constant heat transfer coefficient**, the heat transfer coefficient is simply the constant value specified in the block dialog box,

$$h_{L-W} = h_{Const},$$

where:

- h_{L-W} is the liquid-wall heat transfer coefficient.
- h_{Const} is the **Liquid-wall heat transfer coefficient value** specified in the block dialog box.

For all other heat transfer coefficient parameterizations, the heat transfer coefficient is defined as the arithmetic average of the port heat transfer coefficients:

$$h_{L-W} = \frac{h_A + h_B}{2},$$

where:

- h_A and h_B are the liquid-wall heat transfer coefficients at ports A and B.

The heat transfer coefficient at port A is

$$h_A = \frac{Nu_A k_A}{D_{h,heat}},$$

while at port B it is

$$h_B = \frac{Nu_B k_B}{D_{h,heat}},$$

where:

- Nu_A and Nu_B are the Nusselt numbers at ports A and B.
- k_A and k_B are the thermal conductivities at ports A and B.
- $D_{h,heat}$ is the hydraulic diameter for heat transfer calculations.

The hydraulic diameter used in heat transfer calculations is defined as

$$D_{h,heat} = \frac{4S_{Min}L_{heat}}{S_{heat}},$$

where:

- L_{heat} is the flow path length used in heat transfer calculations.
- S_{heat} is the total heat transfer surface area.

Nusselt Number Calculations

The Nusselt number calculation depends on the **Heat transfer coefficient specification** setting in the block dialog box. If the heat transfer specification is set to Correlations for tubes, the Nusselt number at port A is

$$Nu_A = \begin{cases} Nu_L, & Re_A \leq Re_L \\ \frac{(f_{T,A/8})(Re_A - 1000)Pr_A}{1 + 12.7(f_{T,A/8})^{1/2}(Pr_B^{2/3} - 1)}, & Re_A \geq Re_{T'} \end{cases}$$

while at port B it is

$$Nu_B = \begin{cases} Nu_L, & Re_B \leq Re_L \\ \frac{(f_{T,B/8})(Re_B - 1000)Pr_B}{1 + 12.7(f_{T,B/8})^{1/2}(Pr_B^{2/3} - 1)}, & Re_B \geq Re_{T'} \end{cases}$$

where:

- Nu_L is the **Nusselt number for laminar flow heat transfer** value specified in the block dialog box.
- Pr_A and Pr_B are the Prandtl numbers at ports A and B.

If the heat transfer specification is set to Tabulated data – Colburn data vs. Reynolds number, the Nusselt number at port A is

$$Nu_A = j(Re_{A,heat})Re_{A,heat}Pr_A^{1/3},$$

while at port B it is

$$Nu_B = j(Re_{B,heat})Re_{B,heat}Pr_B^{1/3},$$

where:

- $j(Re_{A,heat})$ and $j(Re_{B,heat})$ are the Colburn numbers at ports A and B. The block obtains the Colburn numbers from tabulated data provided as a function of the Reynolds number.
- $Re_{A,heat}$ and $Re_{B,heat}$ are the Reynolds numbers based on the hydraulic diameters for heat transfer calculations at ports A and B. This parameter is defined at port A as

$$Re_{A,heat} = \frac{\dot{m}_A D_{h,heat}}{S_{Min} \mu_A},$$

and at port B as

$$Re_B = \frac{\dot{m}_B D_{h,heat}}{S_{Min} \mu_B}.$$

If the heat transfer specification is set to **Tabulated data – Nusselt number vs. Reynolds number & Prandtl number**, the Nusselt number at port A is

$$Nu_A = Nu(Re_{A,heat}, Pr_A),$$

while at port B it is

$$Nu_B = Nu(Re_{B,heat}, Pr_B).$$

Hydraulic Diameter Calculations

The hydraulic diameter used in heat transfer calculations can differ from the hydraulic diameter employed in pressure loss calculations, and are different if the heated and friction perimeters are not the same. For a concentric pipe heat exchanger with an annular cross-section, the hydraulic diameter for heat transfer calculations is

$$D_{h,heat} = \frac{4(\pi/4)(D_o^2 - D_i^2)}{\pi D_i} = \frac{D_o^2 - D_i^2}{D_i},$$

while the hydraulic diameter for pressure calculations is

$$D_{h,p} = \frac{4(\pi/4)(D_o^2 - D_i^2)}{\pi(D_i + D_o)} = D_o - D_i,$$

where:

- D_o is the outer annulus diameter.
- D_i is the inner annulus diameter.



Annulus Schematic

Parameters

Parameters Tab

Minimum free-flow area

Aggregate flow area free of obstacles based on the smallest tube spacing or corrugation pitch. The default value is 0.01 m^2 .

Hydraulic diameter for pressure loss

Hydraulic diameter of the tubes or channels comprising the heat exchange interface. The hydraulic diameter is the ratio of the flow cross-sectional area to the channel perimeter. The default value is 0.1 m.

Laminar flow upper Reynolds number limit

Reynolds number corresponding to the upper bound of the laminar flow regime. The flow transitions to turbulent above this value. The default value is 2000.

Turbulent flow lower Reynolds number limit

Reynolds number corresponding to the lower bound of the turbulent flow regime. The flow transitions to laminar below this value. The default value is 4000.

Pressure loss parameterization

Parameterization used to compute the pressure loss between the inlet and outlet. You can assume a constant loss coefficient, use empirical correlations for tubes, or specify tabulated data for the Darcy friction factor or the Euler number. The default setting is Constant loss coefficient.

Pressure loss coefficient

Dimensionless number used to compute the pressure loss between the inlet and outlet. The pressure loss coefficient is assumed constant and the same for direct and reverse flows. This parameter is visible only if the **Pressure loss parameterization** parameter is set to Constant loss coefficient. The default value is .1.

Length of flow path from inlet to outlet

Distance traversed by the fluid from inlet to outlet. This parameter is visible only if the **Pressure loss parameterization** parameter is set to Correlations for tubes or Tabulated data – Darcy friction factor vs. Reynolds number. The default value is 1 m.

Aggregate equivalent length of local resistances

Pressure loss due to local resistances such as bends, inlets, and fittings, expressed as the equivalent length of those resistances. This parameter is visible only if the **Pressure loss parameterization** parameter is set to Correlations for tubes. The default value is 0.1 m.

Internal surface absolute roughness

Average height of all surface defects on the internal surface of the pipe. The surface roughness enables the calculation of the friction factor in the turbulent flow regime. This parameter is visible only if the **Pressure loss parameterization** parameter is set to Correlations for tubes. The default value is 15e-6 m.

Shape factor for laminar flow viscous friction

Proportionality constant between convective and conductive heat transfer in the laminar regime. The shape factor encodes the effects of component geometry on the laminar friction losses. This parameter is visible only if the **Pressure loss parameterization** parameter is set to Correlations for tubes. The default value is 64.

Reynolds number vector for Darcy friction factor

M-element vector of Reynolds numbers at which to specify the Darcy friction factor. The block uses this vector to create a lookup table for the Darcy friction factor. This parameter is visible only if the **Pressure loss parameterization** parameter is set to Tabulated data – Darcy friction factor vs. Reynolds number. The default vector is a 12-element vector ranging in value from 400 to 1e8.

Darcy friction factor vector

M-element vector of Darcy friction factors corresponding to the values specified in the **Reynolds number vector for Darcy friction factor** parameter. The block uses this vector to create a

lookup table for the Darcy friction factor. This parameter is visible only if the **Pressure loss parameterization** parameter is set to Tabulated data – Darcy friction factor vs. Reynolds number. The default vector is a 12-element vector ranging in value from 0.0214 to 0.2640.

Reynolds number vector for Euler number

M-element vector of Reynolds numbers at which to specify the Euler number. The block uses this vector to create a lookup table for the Euler number. This parameter is visible only if the **Pressure loss parameterization** parameter is set to Tabulated data – Euler number vs. Reynolds number.

Euler number vector

M-element vector of Euler numbers corresponding to the values specified in the **Reynolds number vector for Euler number** parameter. The block uses this vector to create a lookup table for the Euler number. This parameter is visible only if the **Pressure loss parameterization** parameter is set to Tabulated data – Euler number vs. Reynolds number.

Heat transfer parameterization

Parameterization used to compute the heat transfer rate between the heat exchanger fluids. You can assume a constant loss coefficient, use empirical correlations for tubes, or specify tabulated data for the Colburn or Nusselt number. The default setting is Constant loss coefficient.

Heat transfer surface area

Aggregate surface area available for heat transfer between the heat exchanger fluids. This parameter is visible only when the **Heat transfer parameterization** parameter is set to Correlation for tubes, Tabulated data – Colburn factor vs. Reynolds number, or Tabulated data – Nusselt number vs. Reynolds number & Prandtl number. The default value is 0.4 m².

Liquid-wall heat transfer coefficient

Heat transfer coefficient between the thermal liquid and the heat-transfer surface. This parameter is visible only when the **Heat transfer parameterization** parameter is set to Constant heat transfer coefficient. The default value is 100.

Length of flow path for heat transfer

Distance traversed by the fluid along which heat exchange takes place. This parameter is visible only when the **Heat transfer parameterization** parameter is set to Correlation for tubes, Tabulated data – Colburn factor vs. Reynolds number, or Tabulated data – Nusselt number vs. Reynolds number & Prandtl number. The default value is 1 m.

Nusselt number for laminar flow heat transfer

Proportionality constant between convective and conductive heat transfer in the laminar regime. This parameter enables the calculation of convective heat transfer rates in laminar flows. The appropriate value to use depends on component geometry. This parameter is visible only when the **Heat transfer parameterization** parameter is set to Correlation for tubes. The default value is 3.66.

Reynolds number vector for Colburn factor

M-element vector of Reynolds numbers at which to specify the Colburn factor. The block uses this vector to create a lookup table for the Colburn number. This parameter is visible only when the **Heat transfer parameterization** parameter is set to Tabulated data – Colburn factor vs. Reynolds number. The default vector is [100.0, 150.0, 1000.0].

Colburn factor vector

M-element vector of Colburn factors corresponding to the values specified in the **Reynolds number vector for Colburn number** parameter. The block uses this vector to create a lookup

table for the Colburn factor. This parameter is visible only when the **Heat transfer parameterization** parameter is set to Tabulated data – Colburn factor vs. Reynolds number. The default vector is [0.019, 0.013, 0.002].

Reynolds number vector for Nusselt number

M-element vector of Reynolds numbers at which to specify the Nusselt number. The block uses this vector to create a lookup table for the Nusselt number. This parameter is visible only when the **Heat transfer parameterization** parameter is set to Tabulated data – Nusselt number vs. Reynolds number & Prandtl number. The default vector is [100.0, 150.0, 1000.0].

Prandtl number vector for Nusselt number

N-element vector of Prandtl numbers at which to specify the Nusselt number. The block uses this vector to create a lookup table for the Nusselt number. This parameter is visible only when the **Heat transfer parameterization** parameter is set to Tabulated data – Nusselt number vs. Reynolds number & Prandtl number. The default vector is [1.0, 10.0].

Nusselt number table, Nu(Re,Pr)

M-by-N matrix of Nusselt numbers corresponding to the values specified in the **Reynolds number vector for Nusselt number** and **Prandtl number vector for Nusselt number** parameters. The block uses this vector to create a lookup table for the Nusselt factor. This parameter is visible only when the **Heat transfer parameterization** parameter is set to Tabulated data – Nusselt number vs. Reynolds number & Prandtl number. The default matrix is [3.72, 4.21; 3.75, 4.44; 4.21, 7.15].

Fouling factor

Empirical parameter used to quantify the increased thermal resistance due to dirt deposits on the heat transfer surface. The default value is $1e-4 \text{ m}^2\text{K/W}$.

Effects and Initial Conditions

Thermal Liquid dynamic compressibility

Option to model the pressure dynamics inside the heat exchanger. Setting this parameter to Off removes the pressure derivative terms from the component energy and mass conservation equations. The pressure inside the heat exchanger is then reduced to the weighted average of the two port pressures.

Thermal Liquid initial temperature

Temperature of the internal volume of thermal liquid at the start of simulation.

Thermal Liquid initial pressure

Pressure of the internal volume of thermal liquid at the start of simulation.

Ports

- A — Thermal liquid conserving port representing the thermal liquid inlet
- B — Thermal liquid conserving port representing the thermal liquid outlet
- C — Physical signal output port for the thermal capacity rate of the thermal liquid
- H — Thermal conserving port associated with the thermal liquid inlet temperature
- HC — Physical signal output port for the heat transfer coefficient between the thermal liquid and the interface wall

Extended Capabilities

C/C++ Code Generation

Generate C and C++ code using Simulink® Coder™.

See Also

E-NTU Heat Transfer | Heat Exchanger Interface (G)

Introduced in R2016a

Heat Exchanger (TL-MA)

Models heat exchange between a moist air network and a thermal liquid network

Library: Simscape / Fluids / Fluid Network Interfaces / Heat Exchangers

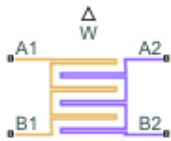

Description

The Heat Exchanger (TL-MA) block models a heat exchanger with one moist air network, which flows between ports **A2** and **B2**, and one thermal liquid network, which flows between ports **A1** and **B1**. The fluid streams can be aligned in parallel, counter, or cross-flow configurations.

A thermal liquid-moist air heat exchanger is not appropriate for refrigeration cooling systems. See Condenser Evaporator (2P-MA) or Condenser Evaporator (TL-2P) for heat exchangers that can be employed in refrigeration applications.

You can model the moist air side as flow within tubes, flow around thermal liquid tubing, or by an empirical, generic parameterization. The moist air side comprises air, trace gas, and water vapor that may condense throughout the heat exchange cycle. The block model accounts for the latent heat that is released when water condenses on the heat transfer surface. This liquid layer does not collect on the surface and is assumed to be completely removed from the downstream moist air flow. The moisture condensation rate is returned as a physical signal at port **W**.

The block uses the Effectiveness-NTU (E-NTU) method to model heat transfer through the shared wall. Fouling on the exchanger walls, which increases thermal resistance and reduces the heat exchange between the two fluids, is also modeled. You can also optionally model fins on both the moist air and thermal liquid sides. Pressure loss due to viscous friction on both sides of the exchanger can be modeled analytically or by generic parameterization, which you can use to tune to your own data.

You can model the thermal liquid side as flow within tubes, flow around moist air tubing, or by an empirical, generic parameterization.

Heat Exchanger Configuration

The heat exchanger effectiveness is based on the selected heat exchanger configuration, the fluid properties, the tube geometry and flow configuration on each side of the exchanger, and the usage and size of fins.

Flow Arrangement

The **Flow arrangement** parameter assigns the relative flow paths between the two sides:

- `Parallel` flow indicates the fluids are moving in the same direction.

- Counter flow indicates the fluids are moving in parallel, but opposite directions.
- Cross flow indicates the fluids are moving perpendicular to each other.

Thermal Mixing

When **Flow arrangement** is set to Cross flow, use the **Cross flow arrangement** parameter to indicate whether the thermal liquid or moist air flows are separated into multiple paths by baffles or walls. Without these separations, the flow can mix freely and is considered *mixed*. Both fluids, one fluid, or neither fluid can be mixed in the cross-flow arrangement. Mixing homogenizes the fluid temperature along the direction of flow of the second fluid, and varies perpendicular to the second fluid flow.

Unmixed flows vary in temperature both along and perpendicular to the flow path of the second fluid.

Sample Cross-Flow Configurations

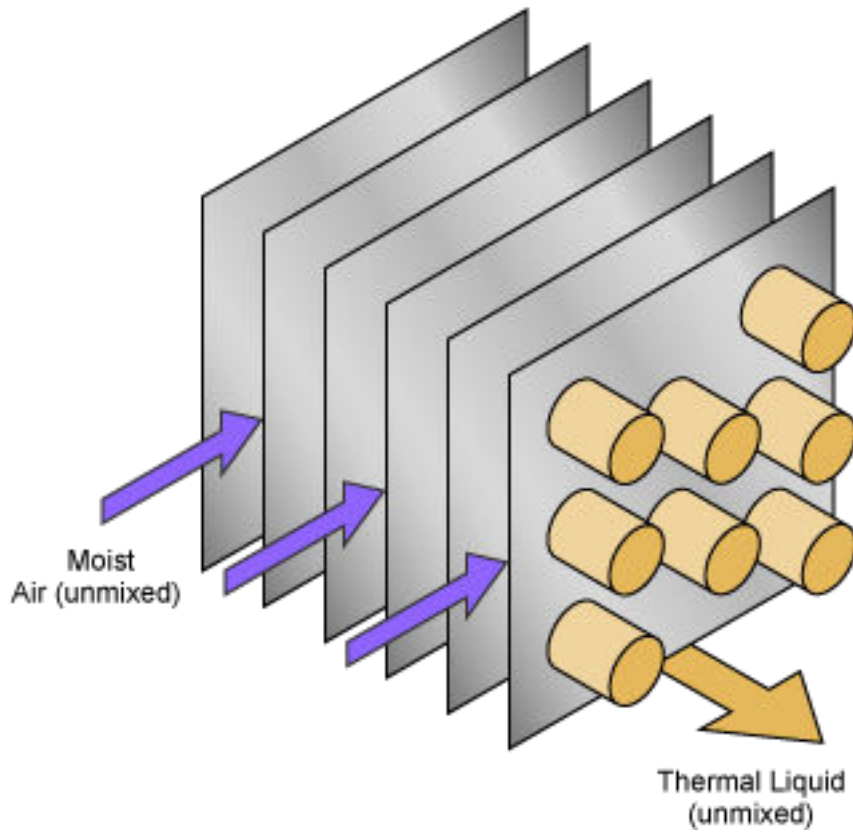
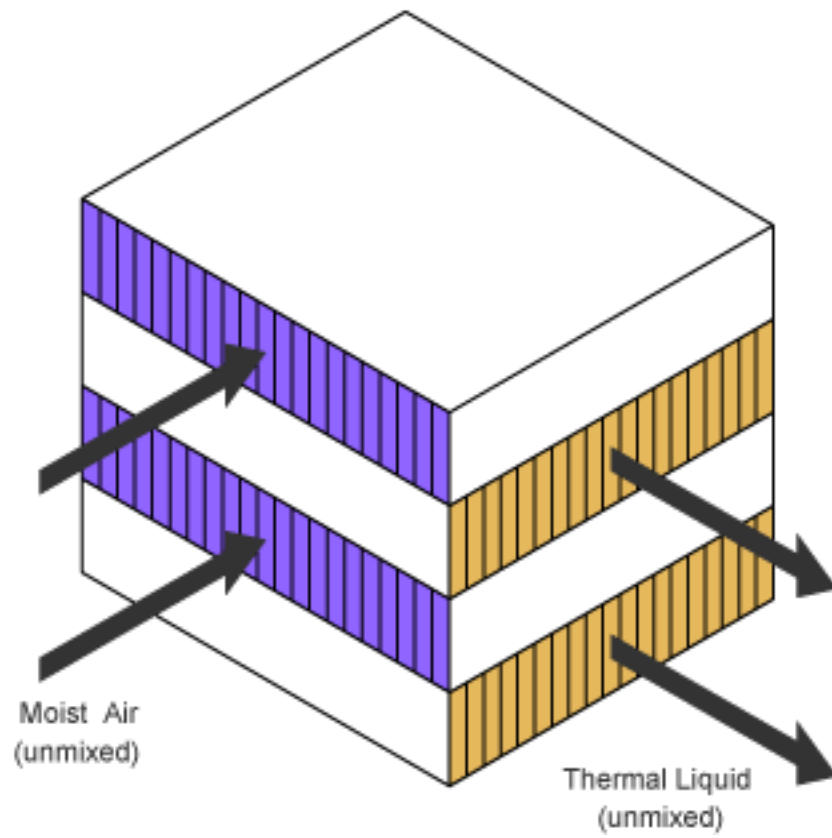

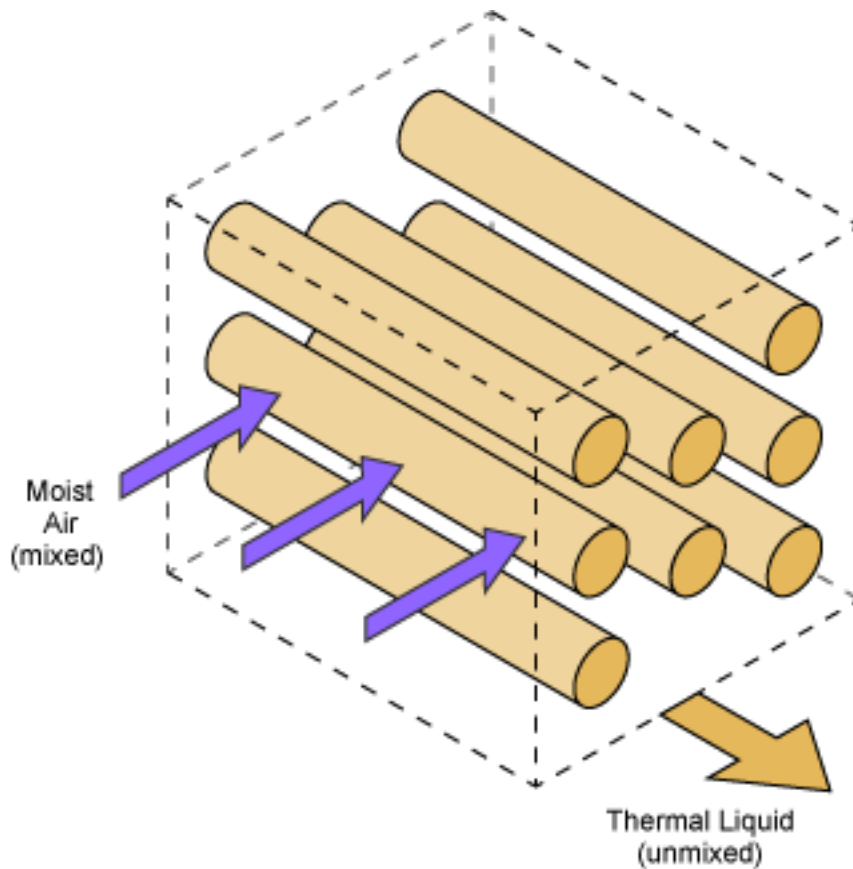

Note that the flow direction during simulation does not impact the selected flow arrangement setting. The ports on the block do not reflect the physical positions of the ports in the physical heat exchange system.

All flow arrangements are single-pass, which means that the fluids do not make multiple turns in the exchanger for additional points of heat transfer. To model a multi-pass heat exchanger, you can arrange multiple Heat Exchanger (TL-MA) blocks in series or in parallel.

For example, to achieve a two-pass configuration on the moist air side and a single-pass configuration on the thermal liquid side, you can connect the moist air sides in series and the thermal liquid sides to the same input in parallel (such as two Mass Flow Rate Source blocks with half of the total mass flow rate), as shown below.

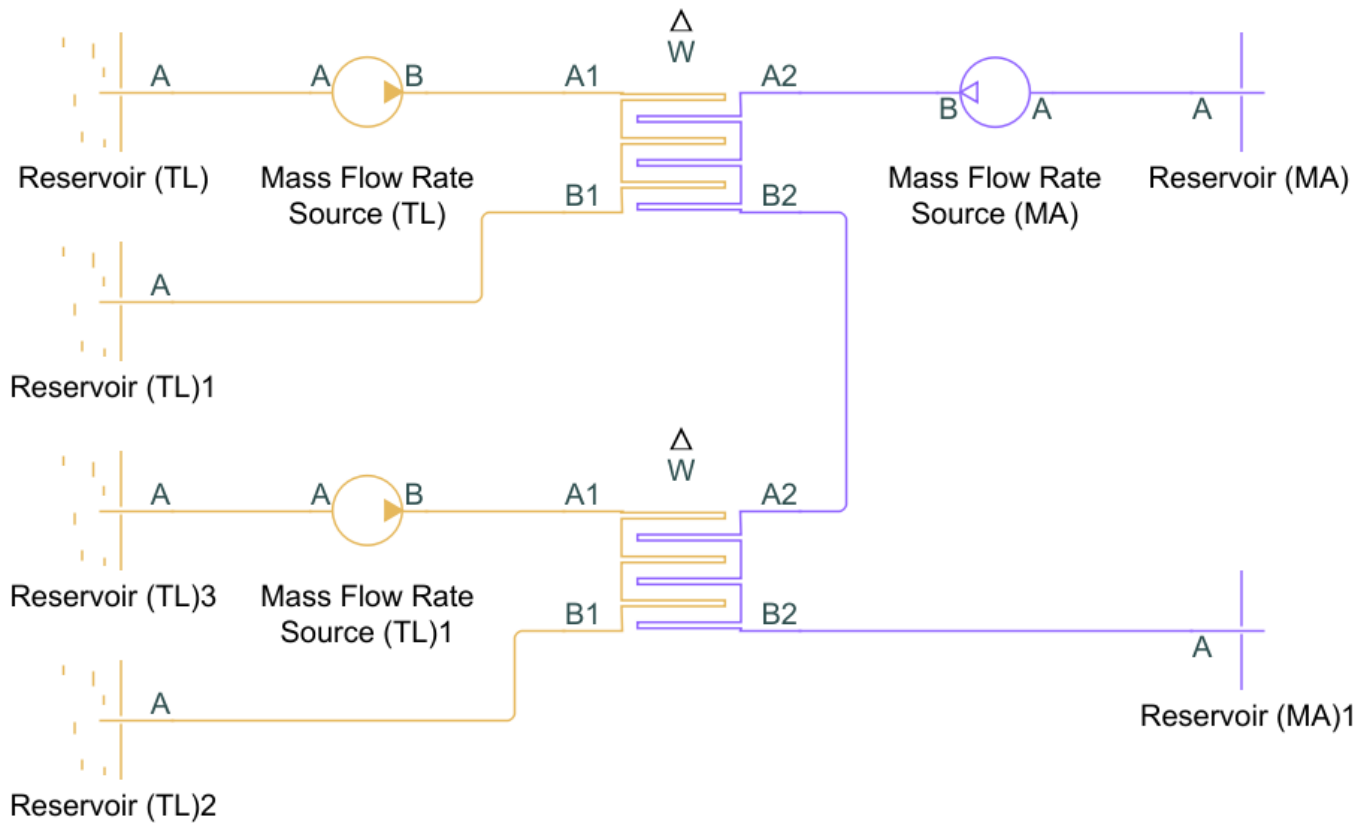

Flow Geometry

The **Flow geometry** parameter sets the flow arrangement of the fluid of the respective dialog tab as either inside a tube or set of tubes, or perpendicular to a tube bank. You can also specify an empirical, generic configuration.

When **Flow geometry** is set to Flow perpendicular to bank of circular tubes, use the **Tube bank grid arrangement** parameter to define the tube bank alignment of the other fluid as either Inline or Staggered. The red, downward-pointing arrow in the figure below indicates the direction of the fluid flowing external to the tube bank. The Inline figure also shows the **Number of tube rows along flow direction** and the **Number of tube segments in each tube row** parameters. Here, *flow direction* refers to the fluid of the respective dialog tab, and *tube* refers to the tubing of the other fluid. The **Length of each tube segment in a tube row** parameter is indicated in the Staggered figure.

Number of tube segments
in each tube row

Inline

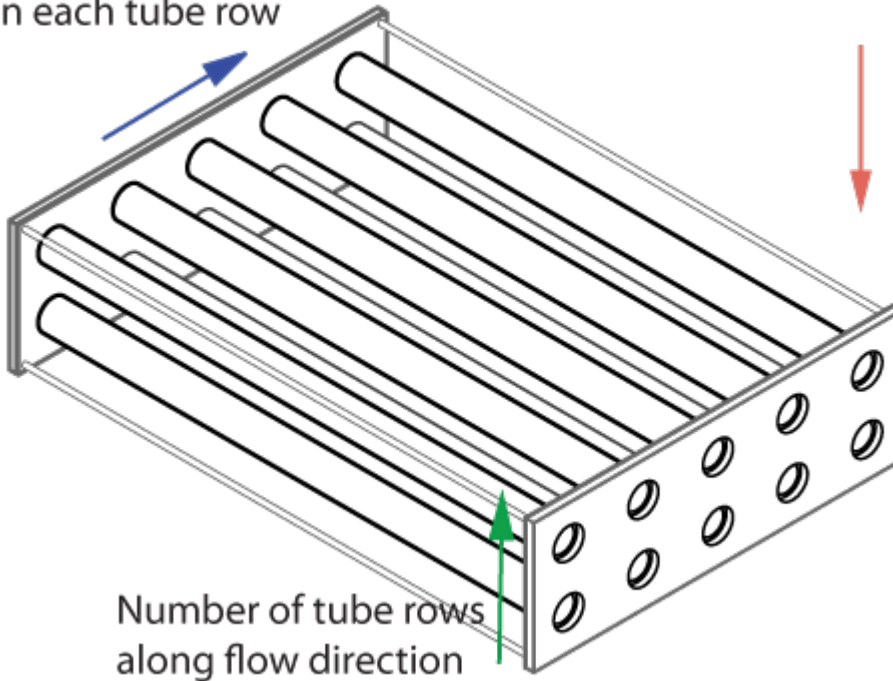

Staggered

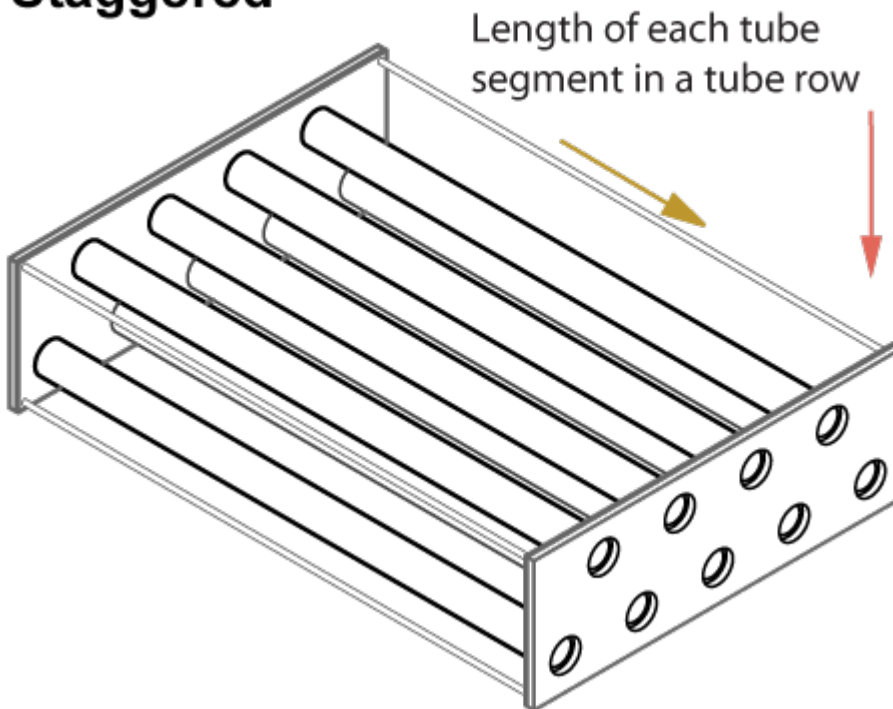

Only one fluid can have **Flow geometry** set to Flow perpendicular to bank of circular tubes at a time. The other fluid must be configured to either Flow inside one or more tubes or Generic. If **Flow geometry** for both fluids is set to Flow perpendicular to bank of circular tubes, you will receive an error.

Fins

The heat exchanger configuration is without fins when the **Total fin surface area** parameter is set to 0 m². Fins introduce additional surface area for additional heat transfer. Each fluid side has a separate fin area.

Effectiveness-NTU Heat Transfer

The heat transfer rate is calculated over the averaged properties of both fluids.

The heat transfer is calculated as:

$$Q = \epsilon C_{\text{Min}}(T_{\text{In,TL}} - T_{\text{In,MA}}),$$

where:

- C_{Min} is the lesser of the heat capacity rates of the two fluids. The heat capacity rate is the product of the fluid specific heat, c_p , and the fluid mass flow rate. C_{Min} is always positive.
- $T_{\text{In,TL}}$ is the inlet temperature of the thermal liquid.
- $T_{\text{In,MA}}$ is the inlet temperature of the moist air.
- ϵ is the heat exchanger effectiveness.

Effectiveness is a function of the heat capacity rate and the number of transfer units, NTU , and also varies based on the heat exchanger flow arrangement, which is discussed in more detail in “Effectiveness by Flow Arrangement” on page 1-955. The NTU is calculated as:

$$NTU = \frac{1}{C_{\text{Min}}R},$$

where R is the total thermal resistance between the two flows, due to convection, conduction, and any fouling on the tube walls:

$$R = \frac{1}{U_{\text{TL}}A_{\text{Th,TL}}} + \frac{F_{\text{TL}}}{A_{\text{Th,TL}}} + R_{\text{W}} + \frac{F_{\text{MA}}}{A_{\text{Th,MA}}} + \frac{1}{U_{\text{MA}}A_{\text{Th,MA}}},$$

and where:

- U is the convective heat transfer coefficient of the respective fluid. This coefficient is discussed in more detail in “Heat Transfer Coefficients” on page 1-956.
- F is the **Fouling factor** on the thermal liquid or moist air side, respectively.
- R_{W} is the **Thermal resistance through heat transfer surface**.
- A_{Th} is the heat transfer surface area of the respective side of the exchanger. A_{Th} is the sum of the wall surface area, A_{W} , and the **Total fin surface area**, A_{F} :

$$A_{\text{Th}} = A_{\text{W}} + \eta_{\text{F}}A_{\text{F}},$$

where η_{F} is the **Fin efficiency**.

Effectiveness by Flow Arrangement

The heat exchanger effectiveness varies according to its flow configuration and the mixing in each fluid.

- When **Flow arrangement** is set to Parallel flow:

$$\epsilon = \frac{1 - \exp[-NTU(1 + C_R)]}{1 + C_R}$$

- When **Flow arrangement** is set to Counter flow:

$$\epsilon = \frac{1 - \exp[-NTU(1 - C_R)]}{1 - C_R \exp[-NTU(1 - C_R)]}$$

- When **Flow arrangement** is set to Cross flow and **Cross flow arrangement** is set to Both fluids unmixed:

$$\epsilon = 1 - \exp\left\{\frac{NTU^{0.22}}{C_R} [\exp(-C_R NTU^{0.78}) - 1]\right\}$$

- When **Flow arrangement** is set to Cross flow and **Cross flow arrangement** is set to Both fluids mixed:

$$\epsilon = \left[\frac{1}{1 - \exp(-NTU)} + \frac{C_R}{1 - \exp(-C_R NTU)} - \frac{1}{NTU} \right]^{-1}$$

When one fluid is mixed and the other unmixed, the equation for effectiveness depends on the relative heat capacity rates of the fluids. When **Flow arrangement** is set to Cross flow and **Cross flow arrangement** is set to either Thermal Liquid 1 mixed & Moist Air 2 unmixed or Thermal Liquid 1 unmixed & Moist Air 2 mixed:

- When the fluid with C_{\max} is mixed and the fluid with C_{\min} is unmixed:

$$\epsilon = \frac{1}{C_R} (1 - \exp\{-C_R [1 - \exp(-NTU)]\})$$

- When the fluid with C_{\min} is mixed and the fluid with C_{\max} is unmixed:

$$\epsilon = 1 - \exp\left\{-\frac{1}{C_R} [1 - \exp(-C_R NTU)]\right\}$$

C_R denotes the ratio between the heat capacity rates of the two fluids:

$$C_R = \frac{C_{\min}}{C_{\max}}$$

Condensation

On the moist air side, a layer of condensation may form on the heat transfer surface. This liquid layer can influence the amount of heat transferred between the moist air and thermal liquid. The equations for E-NTU heat transfer above are given for *dry* heat transfer. To correct for the influence of condensation, the E-NTU equations are additionally calculated with the wet parameters listed below. Whichever of the two calculated heat flow rates results in a larger amount of moist air side cooling is used in heat calculations for each zone [1]. To use this method, the Lewis number is assumed to be close to 1 [1], which is true for moist air.

E-NTU Quantities Used for Heat Transfer Rate Calculations

	Dry calculation	Wet calculation
Moist air zone inlet temperature	$T_{in,MA}$	$T_{in,wb,MA}$
Heat capacity rate	$\bar{m}_{MA}\bar{c}_{p,MA}$	$\bar{m}_{MA}\bar{c}_{eq,MA}$
Heat transfer coefficient	U_{MA}	$U_{MA}\frac{\bar{c}_{eq,MA}}{\bar{c}_{p,MA}}$

where:

- $T_{in,MA}$ is the moist air inlet temperature.
- $T_{in,wb,MA}$ is the moist air wet-bulb temperature associated with $T_{in,MA}$.
- \bar{m}_{MA} is the dry air mass flow rate.
- $\bar{c}_{p,MA}$ is the moist air heat capacity per unit mass of dry air.
- $\bar{c}_{eq,MA}$ is the equivalent heat capacity. The *equivalent heat capacity* is the change in the moist air specific enthalpy (per unit of dry air), \bar{h}_{MA} , with respect to temperature at saturated moist air conditions:

$$\bar{c}_{eq,MA} = \left(\frac{\partial \bar{h}_{MA}}{\partial T_{MA}} \right)_s.$$

The mass flow rate of the condensed water vapor leaving the moist air mass flow depends on the relative humidity between the moist air inlet and the channel wall and the heat exchanger NTUs:

$$\dot{m}_{cond} = -\bar{m}_{MA}(W_{wall,MA} - W_{in,MA})(1 - e^{-NTU_{MA}}),$$

where:

- $W_{wall,MA}$ is the humidity ratio at the heat transfer surface.
- $W_{in,MA}$ is the humidity ratio at the moist air flow inlet.
- NTU_{MA} is the number of transfer units on the moist air side, calculated as:

$$NTU_{MA} = \frac{U_{MA}\frac{\bar{c}_{eq,MA}}{\bar{c}_{p,MA}}A_{Th,MA}}{\bar{m}_{MA}\bar{c}_{eq,MA}}.$$

The energy flow associated with water vapor condensation is based on the difference between the vapor specific enthalpy, $h_{water,wall}$, and the specific enthalpy of vaporization, h_{fg} , for water:

$$\phi_{Cond} = \dot{m}_{cond}(h_{water,wall} - h_{fg}).$$

The condensate is assumed to not accumulate on the heat transfer surface, and does not influence geometric parameters such as tube diameter.

Heat Transfer Coefficients

The equations below apply to both the thermal liquid and moist air sides and use the respective fluid properties.

Flow Inside Tubes

The convective heat transfer coefficient varies according to the fluid Nusselt number:

$$U = \frac{Nu k}{D_H},$$

where:

- Nu is the mean Nusselt number, which depends on the flow regime.
- k is the fluid thermal conductivity.
- D_H is tube hydraulic diameter.

For turbulent flows, the Nusselt number is calculated with the Gnielinski correlation:

$$Nu = \frac{\frac{fD}{8}(Re - 1000)Pr}{1 + 12.7\sqrt{\frac{f}{8}}(Pr^{2/3} - 1)},$$

where:

- Re is the fluid Reynolds number.
- Pr is the fluid Prandtl number.

For laminar flows, the Nusselt number is set by the **Laminar flow Nusselt number** parameter.

For transitional flows, the Nusselt number is a blend between the laminar and turbulent Nusselt numbers.

Flow Across a Tube Bank

When **Flow geometry** is set to Flow perpendicular to bank of circular tubes, the Nusselt number is calculated based on the Hagen number, Hg , and depends on the **Tube bank grid arrangement** setting:

$$Nu = \begin{cases} 0.404Lq^{1/3} \left(\frac{Re+1}{Re+1000} \right)^{0.1}, & \text{Inline} \\ 0.404Lq^{1/3}, & \text{Staggered} \end{cases}$$

where:

$$Lq = \begin{cases} 1.18Pr \left(\frac{4l_T/\pi - D}{l_L} \right) Hg(Re), & \text{Inline} \\ 0.92Pr \left(\frac{4l_T/\pi - D}{l_D} \right) Hg(Re), & \text{Staggered with } l_L \geq D \\ 0.92Pr \left(\frac{4l_T l_L/\pi - D^2}{l_L l_D} \right) Hg(Re), & \text{Staggered with } l_L < D \end{cases}$$

- D is the **Tube outer diameter**.
- l_L is the **Longitudinal tube pitch (along flow direction)**, the distance between the tube centers along the flow direction. *Flow direction* is the direction of flow of the external fluid.

- l_T is the **Transverse tube pitch (perpendicular to flow direction)**, the distance between the centers of the tubing in one row of the other fluid.
- l_D is the diagonal tube spacing, calculated as $l_D = \sqrt{\left(\frac{l_T}{2}\right)^2 + l_L^2}$.

For more information on calculating the Hagen number, see [6].

The measurements l_L and l_T are shown in the tube bank cross-section below. These distances are the same for both grid bank arrangement types.

Cross-section of Tubing with Pitch Measurements

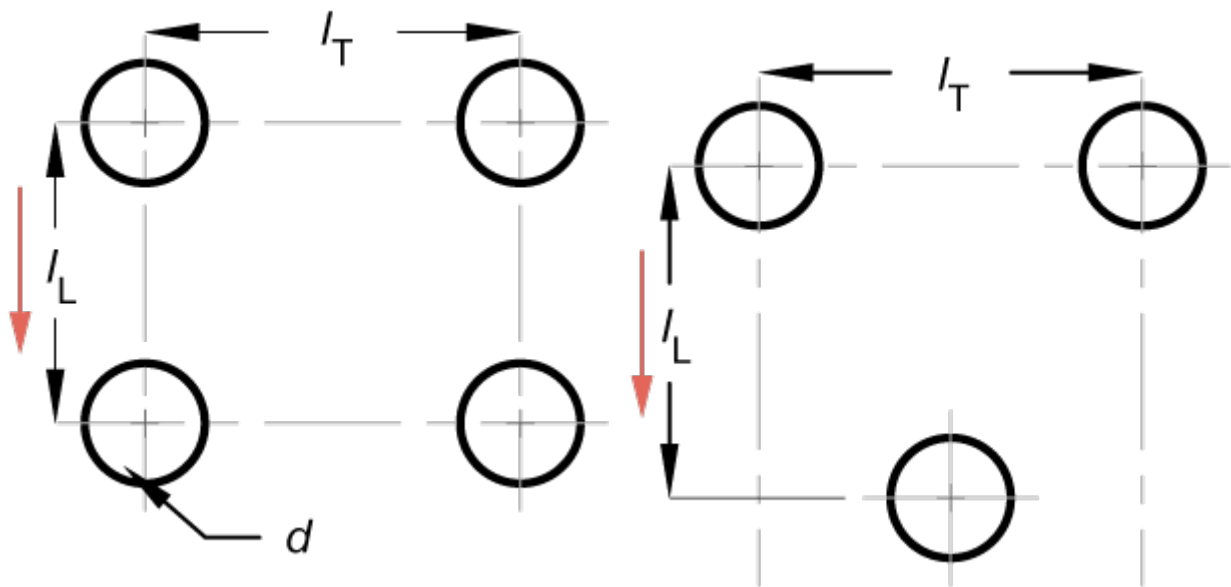

Empirical Nusselt Number Formulation

When the **Heat transfer coefficient model** parameter is set to Colburn equation or when **Flow geometry** is set to Generic, the Nusselt number is calculated by the empirical the Colburn equation:

$$\text{Nu} = a\text{Re}^b\text{Pr}^c,$$

where a , b , and c are defined in the **Coefficients [a, b, c] for $a\text{Re}^b\text{Pr}^c$** parameter.

Pressure Loss

The equations below apply to both the thermal liquid and moist air sides and use the respective fluid properties.

Flows Inside Tubes

The pressure loss due to viscous friction varies depending on flow regime and configuration.

For turbulent flows, when the Reynolds number is above the **Turbulent flow lower Reynolds number limit**, and when **Pressure loss model** is set to Correlations for flow inside tubes, the pressure loss due to friction is calculated in terms of the Darcy friction factor.

For the thermal liquid side, the pressure differential between a port **A1** and the internal node I1 is:

$$p_{A1} - p_{I1} = \frac{f_{D,A} \dot{m}_{A1} |\dot{m}_{A1}|}{2\rho D_H A_{CS}^2} \left(\frac{L + L_{Add}}{2} \right),$$

where:

- \dot{m}_{A1} is the total flow rate through port **A1**.
- $f_{D,A}$ is the Darcy friction factor, according to the Haaland correlation:

$$f_{D,A1} = \left\{ -1.8 \log_{10} \left[\frac{6.9}{Re_{A1}} + \left(\frac{\epsilon_R}{3.7 D_H} \right)^{1.11} \right] \right\}^{-2},$$

where ϵ_R is the thermal liquid pipe **Internal surface absolute roughness**. Note that the friction factor is dependent on the Reynolds number, and is calculated at both ports for each liquid.

- L is the **Total length of each tube** on the thermal liquid side.
- L_{Add} is the thermal liquid side **Aggregate equivalent length of local resistances**, which is the equivalent length of a tube that introduces the same amount of loss as the sum of the losses due to other local resistances in the tube.
- A_{CS} is the total tube cross-sectional area.

The pressure differential between port **B1** and internal node I1 is:

$$p_{B1} - p_{I1} = \frac{f_{D,B} \dot{m}_{B1} |\dot{m}_{B1}|}{2\rho D_H A_{CS}^2} \left(\frac{L + L_{Add}}{2} \right),$$

where \dot{m}_{B1} is the total flow rate through port **B1**.

The Darcy friction factor at port **B1** is:

$$f_{D,B1} = \left\{ -1.8 \log_{10} \left[\frac{6.9}{Re_{B1}} + \left(\frac{\epsilon_R}{3.7 D_H} \right)^{1.11} \right] \right\}^{-2}.$$

For laminar flows, when the Reynolds number is below the **Laminar flow upper Reynolds number limit**, and when **Pressure loss model** is set to **Correlations for flow inside tubes**, the pressure loss due to friction is calculated in terms of the **Laminar friction constant for Darcy friction factor**, λ . λ is a user-defined parameter when **Tube cross-section** is set to **Generic**, otherwise, the value is calculated internally.

The pressure differential between port **A1** and internal node I1 is:

$$p_{A1} - p_{I1} = \frac{\lambda \mu \dot{m}_{A1}}{2\rho D_H^2 A_{CS}} \left(\frac{L + L_{Add}}{2} \right),$$

where μ is the fluid dynamic viscosity. The pressure differential between port **B1** and internal node I1 is:

$$p_{B1} - p_{I1} = \frac{\lambda \mu \dot{m}_{B1}}{2\rho D_H^2 A_{CS}} \left(\frac{L + L_{Add}}{2} \right).$$

For transitional flows, when **Pressure loss model** is set to **Correlations for flow inside tubes**, the pressure differential due to viscous friction is a smoothed blend between the values for laminar and turbulent pressure losses.

Empirical Formulation for Flows Inside Tubes

When **Pressure loss model** is set to **Pressure loss coefficient** or when **Flow geometry** is set to **Generic**, the pressure losses due to viscous friction are calculated with an empirical pressure loss coefficient, ξ . The same equations apply to both the moist air and thermal liquid sides and use the respective fluid properties.

For the thermal liquid side, the pressure differential between port **A1** and internal node I1 is:

$$p_{A1} - p_{I1} = \frac{1}{2} \xi \frac{\dot{m}_{A1} |\dot{m}_{A1}|}{2 \rho A_{CS}^2}.$$

The pressure differential between port **B1** and internal node I1 is:

$$p_{B1} - p_{I1} = \frac{1}{2} \xi \frac{\dot{m}_{B1} |\dot{m}_{B1}|}{2 \rho A_{CS}^2}.$$

Pressure Loss for Flow Across Tube Banks

When **Flow geometry** is set to **Flow perpendicular to bank of circular tubes**, the Hagen number is used to calculate the pressure loss due to viscous friction. The same equations apply to both the moist air and thermal liquid sides and use the respective fluid properties.

For the moist air side, the pressure differential between port **A2** and internal node I2 is:

$$p_{A2} - p_{I2} = \frac{1}{2} \frac{\mu^2 N_R}{\rho D^2} \text{Hg}(\text{Re}),$$

where:

- μ is the moist air fluid dynamic viscosity.
- N_R is the **Number of tube rows along flow direction**. When moist air is flowing external to a tube bank, this is the number of thermal liquid tube rows along the direction of the moist air flow.

The pressure differential between port **B2** and internal node I2 is:

$$p_{B2} - p_{I2} = \frac{1}{2} \frac{\mu^2 N_R}{\rho D^2} \text{Hg}(\text{Re}).$$

Empirical Formulation for Flows Across Tubes

When the **Pressure loss model** is set to **Euler number per tube row** or when **Flow geometry** is set to **Generic**, the pressure loss due to viscous friction is calculated with a pressure loss coefficient, in terms of the Euler number, Eu :

$$Eu = \frac{\xi}{N_R},$$

where ξ is the empirical pressure loss coefficient.

The pressure differential between port **A2** and internal node I2 is:

$$p_{A2} - p_{I2} = \frac{1}{2} N_R E u \frac{\dot{m}_{A2} |\dot{m}_{A2}|}{2\rho A_{CS}^2}.$$

The pressure differential between port **B2** and internal node I2 is:

$$p_{B2} - p_{I2} = \frac{1}{2} N_R E u \frac{\dot{m}_{B2} |\dot{m}_{B2}|}{2\rho A_{CS}^2}.$$

Conservation Equations

Thermal Liquid

The total mass accumulation rate in the thermal liquid is defined as:

$$\frac{dM_{TL}}{dt} = \dot{m}_{A1} + \dot{m}_{B1},$$

where:

- M_{TL} is the total mass of the thermal liquid.
- \dot{m}_{A1} is the mass flow rate of the fluid at port **A1**.
- \dot{m}_{B1} is the mass flow rate of the fluid at port **B1**.

The flow is positive when flowing into the block through the port.

The energy conservation equation relates the change in specific internal energy to the heat transfer by the fluid:

$$M_{TL} \frac{du_{TL}}{dt} + u_{TL}(\dot{m}_{A1} + \dot{m}_{B1}) = \phi_{A1} + \phi_{B1} - Q,$$

where:

- u_{TL} is the thermal liquid specific internal energy.
- ϕ_{A1} is the energy flow rate at port **A1**.
- ϕ_{B1} is the energy flow rate at port **B1**.
- Q is heat transfer rate, which is positive when leaving the thermal liquid volume.

Moist Air

There are three equations for mass conservation on the moist air side: one for the moist air mixture, one for condensed water vapor, and one for the trace gas.

Note If **Trace gas model** is set to **None** in the Moist Air Properties (MA) block, the trace gas is not modeled in blocks in the moist air network. In the Heat Exchanger (TL-MA) block, this means that the conservation equation for trace gas is set to 0.

The moist air mixture mass accumulation rate accounts for the changes of the entire moist air mass flow through the exchanger ports and the condensation mass flow rate:

$$\frac{dM_{MA}}{dt} = \dot{m}_{A2} + \dot{m}_{B2} - \dot{m}_{\text{Cond}}.$$

The mass conservation equation for water vapor accounts for the water vapor transit through the moist air side and condensation formation:

$$\frac{dx_w}{dt}M_{MA} + x_w(\dot{m}_{A2} + \dot{m}_{B2} - \dot{m}_{Cond}) = \dot{m}_{w,A2} + \dot{m}_{w,B2} - \dot{m}_{Cond},$$

where:

- x_w is the mass fraction of the vapor. $\frac{dx_w}{dt}$ is the rate of change of this fraction.
- $\dot{m}_{w,A2}$ is the water vapor mass flow rate at port **A2**.
- $\dot{m}_{w,B2}$ is the water vapor mass flow rate at port **B2**.
- \dot{m}_{Cond} is the rate of condensation.

The trace gas mass balance is:

$$\frac{dx_g}{dt}M_{MA} + x_g(\dot{m}_{A2} + \dot{m}_{B2} - \dot{m}_{Cond}) = \dot{m}_{g,A2} + \dot{m}_{g,B2},$$

where:

- x_g is the mass fraction of the trace gas. $\frac{dx_g}{dt}$ is the rate of change of this fraction.
- $\dot{m}_{g,A2}$ is the trace gas mass flow rate at port **A2**.
- $\dot{m}_{g,B2}$ is the trace gas mass flow rate at port **B2**.

Energy conservation on the moist air side accounts for the change in specific internal energy due to heat transfer and water vapor condensing out of the moist air mass:

$$M_{MA} \frac{du_{MA}}{dt} + u_{MA}(\dot{m}_{A2} + \dot{m}_{B2} - \dot{m}_{Cond}) = \phi_{A2} + \phi_{B2} + Q - \phi_{Cond}.$$

where:

- ϕ_{A2} is the energy flow rate at port **A2**.
- ϕ_{B2} is the energy flow rate at port **B2**.
- ϕ_{Cond} is the energy flow rate due to condensation.

The heat transferred to or from the moist air, Q , is equal to the heat transferred from or to the thermal liquid.

Ports

Conserving

A1 — Thermal liquid port

thermal liquid

Inlet or outlet port associated with the thermal liquid.

B1 — Thermal liquid port

thermal liquid

Inlet or outlet port associated with the thermal liquid.

A2 — Moist air port

moist air

Inlet or outlet port associated with the moist air.

B2 — Moist air port

moist air

Inlet or outlet port associated with the moist air.

Output

W — Moist air condensation rate

physical signal

Water condensation rate in the moist air flow. The condensate does not accumulate on the heat transfer surface.

Parameters

Configuration

Flow arrangement — Flow path alignment

Cross flow (default) | Parallel flow | Counter flow

Flow path alignment between heat exchanger sides. The available flow arrangements are:

- Parallel flow. The flows run in the same direction.
- Counter flow. The flows run parallel to each other, in the opposite directions.
- Cross flow. The flows run perpendicular to each other.

Cross flow arrangement — Thermal mixing condition in each of the flow channels

Thermal Liquid 1 unmixed & Moist Air 2 mixed (default) | Both fluids unmixed | Thermal Liquid 1 mixed & Moist Air 2 unmixed | Both fluids mixed

Select whether each of the fluids can mix in its channel. Mixed flow means that the fluid is free to move in the transverse direction as it travels along the flow path. Unmixed flow means that the fluid is restricted to travel only along the flow path. For example, a side with fins is considered an unmixed flow.

Dependencies

To enable this parameter, set **Flow arrangement** to Cross flow.

Thermal resistance through heat transfer surface — Wall thermal resistance

0 K/kW (default) | positive scalar

Thermal resistance of the wall separating the two sides of the heat exchanger. The wall thermal resistance, wall fouling, and the fluid convective heat transfer coefficient influence the amount of heat transferred between the flows.

Cross-sectional area at port A1 — Flow area at port A1

0.01 m² (default) | positive scalar

Flow area at the thermal liquid port **A1**.

Cross-sectional area at port B1 — Flow area at port B1

0.01 m² (default) | positive scalar

Flow area at the thermal liquid port **B1**.

Cross-sectional area at port A2 — Flow area at port A2

0.01 m² (default) | positive scalar

Flow area at the moist air port **A2**.

Cross-sectional area at port B2 — Area normal to flow at port B2

0.01 m² (default) | positive scalar

Flow area at the moist air port **B2**.

Thermal Liquid 1

Flow geometry — Thermal liquid flow configuration

Flow inside one or more tubes (default) | Flow perpendicular to bank of circular tubes | Generic

Thermal liquid flow path. The flow can run externally over a set of tubes or internal to a tube or set of tubes. You can also specify a generic parameterization based on empirical values.

Number of tubes — Number of thermal liquid tubes

25 (default) | positive scalar

Number of thermal liquid tubes. More tubes result in higher pressure losses due to viscous friction, but a larger amount of surface area for heat transfer.

Dependencies

To enable this parameter, set **Flow geometry** to Flow inside one or more tubes.

Total length of each tube — Total length of each thermal liquid tube

1 m (default) | positive scalar

Total length of each thermal liquid tube.

Dependencies

To enable this parameter, set **Flow geometry** to Flow inside one or more tubes.

Tube cross section — Cross-sectional shape of a tube

Circular (default) | Rectangular | Annular | Generic

Cross-sectional shape of one tube. Set to Generic to specify an arbitrary cross-sectional geometry.

Dependencies

To enable this parameter, set **Flow geometry** to Flow inside one or more tubes.

Tube inner diameter — Internal diameter of a single tube

0.05 m (default) | positive scalar

Internal diameter of the cross-section of one tube. The cross-section and diameter are uniform along the tube. The size of the diameter influences the pressure loss and heat transfer calculations.

Dependencies

To enable this parameter, set **Flow geometry** to Flow inside one or more tubes and **Tube cross-section** to Circular.

Tube width — Internal width of a single tube

0.05 m (default) | positive scalar

Internal width of the cross-section of one tube. The cross-section and width are uniform along the tube. The width and height influence the pressure loss and heat transfer calculations.

Dependencies

To enable this parameter, set **Flow geometry** to Flow inside one or more tubes and **Tube cross-section** to Rectangular.

Tube height — Internal height of a single tube

0.05 m (default) | positive scalar

Internal height of one tube cross-section. The cross-section and height are uniform along the tube. The width and height influence the pressure loss and heat transfer calculations.

Dependencies

To enable this parameter, set **Flow geometry** parameterization of Flow inside one or more tubes and **Tube cross-section** to Rectangular.

Annulus inner diameter (heat transfer surface) — Smaller diameter of annular cross-section

0.05 m (default) | positive scalar

Smaller diameter of the annular cross-section of one tube. The cross-section and inner diameter are uniform along the tube. The inner diameter influences the pressure loss and heat transfer calculations. Heat transfer occurs through the inner surface of the annulus.

Dependencies

To enable this parameter, set **Flow geometry** parameterization of Flow inside one or more tubes and **Tube cross-section** to Annular.

Annulus outer diameter — Larger diameter of annular cross-section

0.1 m (default) | positive scalar

Larger diameter of the annular cross-section of one tube. The cross-section and outer diameter are uniform along the tube. The outer diameter influences the pressure loss and heat transfer calculations.

Dependencies

To enable this parameter, set **Flow geometry** to Flow inside one or more tubes and **Tube cross-section** to Annular.

Cross-sectional area per tube — Internal flow area in each tube

0.002 m² (default) | positive scalar

Internal flow area of each tube.

Dependencies

To enable this parameter, set **Flow geometry** to Flow inside one or more tubes and **Tube cross-section** to Generic.

Wetted perimeter of tube cross-section for pressure loss — Perimeter of tube cross-section that fluid touches

0.15 m (default) | positive scalar

Perimeter of the tube cross-section that the fluid touches. The cross-section and perimeter are uniform along the tube. This value is applied in pressure loss calculations.

Dependencies

To enable this parameter, set **Flow geometry** to Flow inside one or more tubes and **Tube cross-section** to Generic.

Perimeter of tube cross-section for heat transfer — Perimeter of a single tube for heat transfer calculations

0.15 m (default) | positive scalar

Tube perimeter for heat transfer calculations. This is often the same as the tube perimeter, but in cases such as the annular cross-section, this may be only the inner or outer diameter, depending on the heat-transferring surface. The cross-section and tube perimeter are uniform along the tube.

Dependencies

To enable this parameter, set **Flow geometry** to Flow inside one or more tubes and **Tube cross-section** to Generic.

Pressure loss model — Method of pressure loss calculation due to viscous friction

Correlation for flow inside tubes (default) | Euler number per tube row | Pressure loss coefficient | Correlation for flow over tube bank

Method of pressure loss calculation due to viscous friction. Different models are available for different flow configurations. The settings are:

- Correlation for flow inside tubes. Use this setting to calculate the pressure loss with the Haaland correlation.
- Pressure loss coefficient. Use this setting to calculate the pressure loss based on an empirical loss coefficient.
- Euler number per tube row. Use this setting to calculate the pressure loss based on an empirical Euler number.
- Correlation for flow over tube bank. Use this setting to calculate the pressure loss based on the Hagen number.

The pressure loss models available depend on the **Flow geometry** setting.

Dependencies

When **Flow geometry** is set to Flow inside one or more tubes, **Pressure loss model** can be set to either:

- Pressure loss coefficient.
- Correlation for flow inside tubes.

When **Flow geometry** is set to Flow perpendicular to bank of circular tubes, **Pressure loss model** can be set to either:

- Correlation for flow over tube bank.
- Euler number per tube row.

When **Flow geometry** is set to Generic, the **Pressure loss model** parameter is disabled. Pressure loss is calculated empirically with the **Pressure loss coefficient, $\Delta p / (0.5 \cdot \rho \cdot v^2)$** parameter.

Pressure loss coefficient, $\Delta p / (0.5 \cdot \rho \cdot v^2)$ – Empirical loss coefficient for all pressure losses in the channel

10 (default) | positive scalar

Empirical loss coefficient for all pressure losses in the channel. This value accounts for wall friction and minor losses due to bends, elbows, and other geometry changes in the channel.

The loss coefficient can be calculated from a nominal operating condition or be tuned to fit experimental data. It is defined as:

$$\xi = \frac{\Delta p}{\frac{1}{2} \rho v^2},$$

where Δp is the pressure drop, ρ is the thermal liquid density, and v is the flow velocity.

Dependencies

To enable this parameter, set either:

- **Flow geometry** to Flow inside one or more tubes and **Pressure loss model** to Pressure loss coefficient.
- **Flow geometry** to Generic.

Aggregate equivalent length of local resistances – Combined length of all local resistances in the tubes

0.1 m (default) | positive scalar

Combined length of all local resistances in the tubes. This is the length of tubing that results in the same pressure losses as the sum of all minor losses in the tube due to such things as bends, tees, or unions. A longer equivalent length results in larger pressure losses.

Dependencies

To enable this parameter, set **Flow geometry** to Flow inside one or more tubes and **Pressure loss model** to Correlations for flow inside tubes.

Internal surface absolute roughness – Mean surface roughness height

15e-6 m (default) | positive scalar

Mean height of tube surface defects. A rougher wall results in larger pressure losses in the turbulent regime for pressure loss calculated with the Haaland correlation.

Dependencies

To enable this parameter, set **Flow geometry** to Flow inside one or more tubes and either:

- **Pressure loss model**
- **Heat transfer coefficient model**

to Correlation for flow inside tubes.

Laminar flow upper Reynolds number limit – Largest Reynolds number that indicates laminar flow

2000 (default) | positive scalar

Largest Reynolds number that indicates laminar flow. Between this value and the **Turbulent flow lower Reynolds number limit**, the flow regime is transitional.

Dependencies

To enable this parameter, set **Flow geometry** to Flow inside one or more tubes and either:

- **Pressure loss model**
- **Heat transfer model**

to Correlation for flow inside tubes.

Turbulent flow lower Reynolds number limit – Smallest Reynolds number that indicates turbulent flow

4000 (default) | positive scalar

Smallest Reynolds number that indicates turbulent flow. Between this value and the **Laminar flow upper Reynolds number limit**, the flow regime is transitional between the laminar and turbulent regimes.

Dependencies

To enable this parameter, set **Flow geometry** to Flow inside one or more tubes and **Pressure loss model** to Correlation for flow inside tubes.

Laminar friction constant for Darcy friction factor – Coefficient of pressure loss due to viscous friction in laminar flows

64 (default) | positive scalar

Coefficient in pressure loss equations for viscous friction in laminar flows. This parameter is also known as the *shape factor*. The default value corresponds to a circular tube cross-section.

Dependencies

To enable this parameter, set **Flow geometry** to Correlation for flow inside tubes, **Tube cross section** to Generic, and **Pressure loss model** to Correlation for flow inside tubes.

Heat transfer coefficient model – Method of calculating heat transfer coefficient between fluid and wall

Correlation for flow over tube bank (default) | Colburn equation | Correlation for flow inside tubes

Method of calculating the heat transfer coefficient between the fluid and the wall. The available settings are:

- **Colburn equation.** Use this setting to calculate the heat transfer coefficient with user-defined variables a , b , and c of the Colburn equation.
- **Correlation for flow over tube bank.** Use this setting to calculate the heat transfer coefficient based on the tube bank correlation using the Hagen number.
- **Correlation for flow inside tubes.** Use this setting to calculate the heat transfer coefficient for pipe flows with the Gnielinski correlation.

Dependencies

To enable this parameter, set **Flow geometry** to either:

- Flow perpendicular to bank of circular tubes.
- Flow inside one or more tubes.

Coefficients [a, b, c] for $a \cdot Re^b \cdot Pr^c$ – Colburn equation coefficients

[0.023, 0.8, 0.33] (default) | three-element vector

Three-element vector containing the empirical coefficients of the Colburn equation. The Colburn equation is a formulation for calculating the Nusselt Number. The general form of the Colburn equation is:

$$Nu = aRe^bPr^c.$$

When the **Heat transfer coefficient model** is set to **Colburn equation** and **Flow geometry** is set to **Flow inside one or more tubes**, or **Flow geometry** is set to **Generic**, the default Colburn equation is:

$$Nu = 0.023Re^{0.8}Pr^{1/3}.$$

When the **Heat transfer coefficient model** is set to **Colburn equation** and **Flow geometry** is set to **Flow perpendicular to bank of circular tubes**, the default Colburn equation is:

$$Nu = 0.27Re^{0.63}Pr^{0.36}.$$

Dependencies

To enable this parameter, set:

1 **Flow geometry** to either:

- Flow inside one or more tubes
- Flow perpendicular to bank of circular tubes

and **Heat transfer coefficient model** to **Colburn equation**.

2 **Flow geometry** to **Generic**.

Laminar flow Nusselt number – Ratio of convective to conductive heat transfer in the laminar flow regime

3.66 (default) | positive scalar

Ratio of convective to conductive heat transfer in the laminar flow regime. The fluid Nusselt number influences the heat transfer rate and depends on the tube cross-section.

Dependencies

To enable this parameter, set **Flow geometry** to Flow inside one or more tubes, **Tube cross-section** to Generic, and **Heat transfer parameterization** to Correlation for flow inside tubes.

Tube bank grid arrangement — Geometrical placement of tube rows in the bank

Inline (default) | Staggered

Alignment of tubes in a tube bank. Rows are either in line with their neighbors, or staggered.

- **Inline:** All tube rows are located directly behind each other.
- **Staggered:** Tubes of the one tube row are located at the gap between tubes of the previous tube row.

Tube alignment influences the Nusselt number and the heat transfer rate.

Dependencies

To enable this parameter, set **Flow geometry** to Flow perpendicular to bank of circular tubes.

Number of tube rows along flow direction — Number of moist air tube rows in the tube bank

5 (default) | positive scalar

Number of moist air tube rows in a tube bank. The rows are aligned with the direction of thermal liquid flow.

Dependencies

To enable this parameter, set **Flow geometry** to Flow perpendicular to bank of circular tubes.

Number of tube segments in each tube row — Number of moist air tubes in each row of the tube bank

5 (default) | positive scalar

Number of moist air tubes in each row of a tube bank. This measurement is perpendicular to the thermal liquid flow.

Dependencies

To enable this parameter, set **Flow geometry** to Flow perpendicular to bank of circular tubes.

Length of each tube segment in a tube row — Length of each moist air tube

1 m (default) | positive scalar

Length of each moist air tube that spans a tube row. All tubes in a tube bank are the same length.

Dependencies

To enable this parameter, set **Flow geometry** to Flow perpendicular to bank of circular tubes.

Tube outer diameter – Outer diameter of a moist air tube

0.05 m (default) | positive scalar

Outer diameter of a moist air tube. The cross-section is uniform along a tube and so the diameter is constant throughout. This value influences the losses in the flow across a tube bank due to viscous friction.

Dependencies

To enable this parameter, set **Flow geometry** to Flow perpendicular to bank of circular tubes.

Longitudinal tube pitch (along flow direction) – Center-to-center distance between moist air tube rows

0.15 m (default) | positive scalar

Distance between tube centers of the moist air tube bank aligned with the direction of flow of the thermal liquid.

Dependencies

To enable this parameter, set **Flow geometry** to Flow perpendicular to bank of circular tubes.

Transverse tube pitch (perpendicular to flow direction) – Center-to-center distance between moist air fluid tubes in a row

0.15 (default) | positive scalar

Distance between the tube centers in a row of moist air tubes. This measurement is perpendicular to the thermal liquid flow direction. See “Heat Transfer Coefficients” on page 1-956 for more information.

Dependencies

To enable this parameter, set **Flow geometry** to Flow perpendicular to bank of circular tubes.

Euler number per tube row, $\Delta p / (N \cdot 0.5 \cdot \rho \cdot v^2)$ – Euler number for each row of the tube bank

10 (default) | positive scalar

Empirical coefficient for pressure drop across one tube row. The Euler number is the ratio between pressure drop and fluid momentum:

$$Eu = \frac{\Delta p}{N \frac{1}{2} \rho v^2},$$

where N is the **Number of tube rows along flow direction**, Δp is the pressure drop, ρ is the thermal liquid density, and v is the flow velocity.

Each tube row is located in a plane perpendicular to the thermal liquid flow.

Dependencies

To enable this parameter, set either:

- **Flow geometry** to Flow perpendicular to bank of circular tubes and **Pressure loss model** to Euler number per tube row.
- **Flow geometry** to Generic.

Minimum free-flow area — Smallest total flow area between inlet and outlet

0.01 m² (default) | positive scalar

Smallest total flow area between inlet and outlet. If the channel is a collection of ducts, tubes, slots, or grooves, the minimum free-flow area is the sum of the smallest areas.

Dependencies

To enable this parameter, set **Flow geometry** to Generic.

Heat transfer surface area without fins — Total area of the heat transfer surface excluding fins

2 m² (default) | positive scalar

Total area of the heat transfer surface, excluding fins.

Dependencies

To enable this parameter, set **Flow geometry** to Generic.

Thermal liquid volume inside heat exchanger — Total volume of thermal liquid in the heat exchanger

0.05 m³ (default) | positive scalar

Total volume of thermal liquid in the heat exchanger.

Dependencies

To enable this parameter, set **Flow geometry** to Generic.

Fouling factor — Additional thermal resistance due to fouling deposits

0.1 m²*K/kW (default) | positive scalar

Additional thermal resistance due to fouling layers on the surfaces of the wall. In real systems, fouling deposits grow over time. However, the growth is slow enough to be assumed constant during the simulation.

Total fin surface area — Total heat transfer surface area of all fins

0 m² (default) | positive scalar

Total heat transfer surface area of both sides of all fins. For example, if the fin is rectangular, the surface area is double the area of the rectangle.

The total heat transfer surface area is the sum of the channel surface area and the effective fin surface area, which is the product of the **Fin efficiency** and the **Total fin surface area**.

Fin efficiency — Ratio of fin actual to idea heat transfer rates

0.5 (default) | positive scalar in the range [0,1]

Ratio of actual heat transfer to ideal heat transfer through the fins.

Initial thermal liquid pressure — Moist air pressure at the start of simulation

0.101325 MPa (default) | positive scalar

Thermal liquid pressure at the start of the simulation.

Initial thermal liquid temperature — Temperature at the start of simulation

293.15 K (default) | positive scalar | two-element vector

Temperature in the thermal liquid channel at the start of the simulation. This parameter can be a scalar or a two-element vector. A scalar value represents the mean initial temperature in the channel. A vector value represents the initial temperature at the inlet and outlet in the form [inlet, outlet]. The block calculates a linear gradient between the two ports. The inlet and the outlet ports are identified according to the initial flow direction.

Moist Air 2

Flow geometry — Moist air flow configuration

Flow perpendicular to bank of circular tubes (default) | Flow inside one or more tubes | Generic

Moist air flow path. The flow can run externally over a set of tubes or internal to a tube or set of tubes. You can also specify a generic parameterization based on empirical values.

Number of tubes — Number of moist air tubes

25 (default) | positive scalar

Number of moist air tubes. More tubes result in higher pressure losses due to viscous friction, but a larger amount of surface area for heat transfer.

Dependencies

To enable this parameter, set **Flow geometry** to Flow inside one or more tubes.

Total length of each tube — Total length of each moist air tube

1 m (default) | positive scalar

Total length of each moist air tube.

Dependencies

To enable this parameter, set **Flow geometry** to Flow inside one or more tubes.

Tube cross section — Cross-sectional shape of a tube

Circular (default) | Rectangular | Annular | Generic

Cross-sectional shape of one tube. Set to Generic to specify an arbitrary cross-sectional geometry.

Dependencies

To enable this parameter, set **Flow geometry** to Flow inside one or more tubes.

Tube inner diameter — Internal diameter of a single tube

0.05 m (default) | positive scalar

Internal diameter of the cross-section of one tube. The cross-section and diameter are uniform along the tube. The size of the diameter influences the pressure loss and heat transfer calculations.

Dependencies

To enable this parameter, set **Flow geometry** to Flow inside one or more tubes and **Tube cross-section** to Circular.

Tube width — Internal width of a single tube

0.05 m (default) | positive scalar

Internal width of the cross-section of one tube. The cross-section and width are uniform along the tube. The width and height influence the pressure loss and heat transfer calculations.

Dependencies

To enable this parameter, set **Flow geometry** to Flow inside one or more tubes and **Tube cross-section** to Rectangular.

Tube height — Internal height of a single tube

0.05 m (default) | positive scalar

Internal height of one tube cross-section. The cross-section and height are uniform along the tube. The width and height influence the pressure loss and heat transfer calculations.

Dependencies

To enable this parameter, set **Flow geometry** parameterization of Flow inside one or more tubes and **Tube cross-section** to Rectangular.

Annulus inner diameter (heat transfer surface) — Smaller diameter of annular cross-section

0.05 m (default) | positive scalar

Smaller diameter of the annular cross-section of one tube. The cross-section and inner diameter are uniform along the tube. The inner diameter influences the pressure loss and heat transfer calculations. Heat transfer occurs through the inner surface of the annulus.

Dependencies

To enable this parameter, set **Flow geometry** parameterization of Flow inside one or more tubes and **Tube cross-section** to Annular.

Annulus outer diameter — Larger diameter of annular cross-section

0.1 m (default) | positive scalar

Larger diameter of the annular cross-section of one tube. The cross-section and outer diameter are uniform along the tube. The outer diameter influences the pressure loss and heat transfer calculations.

Dependencies

To enable this parameter, set **Flow geometry** to Flow inside one or more tubes and **Tube cross-section** to Annular.

Cross-sectional area per tube — Internal flow area in each tube

0.002 m² (default) | positive scalar

Internal flow area of each tube.

Dependencies

To enable this parameter, set **Flow geometry** to Flow inside one or more tubes and **Tube cross-section** to Generic.

Wetted perimeter of tube cross-section for pressure loss — Perimeter of tube cross-section that fluid touches

0.15 m (default) | positive scalar

Perimeter of the tube cross-section that the fluid touches. The cross-section and perimeter are uniform along the tube. This value is applied in pressure loss calculations.

Dependencies

To enable this parameter, set **Flow geometry** to Flow inside one or more tubes and **Tube cross-section** to Generic.

Perimeter of tube cross-section for heat transfer — Perimeter of a single tube for heat transfer calculations

0.15 m (default) | positive scalar

Tube perimeter for heat transfer calculations. This is often the same as the tube perimeter, but in cases such as the annular cross-section, this may be only the inner or outer diameter, depending on the heat-transferring surface. The cross-section and tube perimeter are uniform along the tube.

Dependencies

To enable this parameter, set **Flow geometry** to Flow inside one or more tubes and **Tube cross-section** to Generic.

Pressure loss model — Method of pressure loss calculation due to viscous friction

Correlation for flow inside tubes (default) | Euler number per tube row | Pressure loss coefficient | Correlation for flow over tube bank

Method of pressure loss calculation due to viscous friction. Different models are available for different flow configurations. The settings are:

- Correlation for flow inside tubes. Use this setting to calculate the pressure loss with the Haaland correlation.
- Pressure loss coefficient. Use this setting to calculate the pressure loss based on an empirical loss coefficient.
- Euler number per tube row. Use this setting to calculate the pressure loss based on an empirical Euler number.
- Correlation for flow over tube bank. Use this setting to calculate the pressure loss based on the Hagen number.

The pressure loss models available depend on the **Flow geometry** setting.

Dependencies

When **Flow geometry** is set to Flow inside one or more tubes, **Pressure loss model** can be set to either:

- Pressure loss coefficient.
- Correlation for flow inside tubes.

When **Flow geometry** is set to Flow perpendicular to bank of circular tubes, **Pressure loss model** can be set to either:

- Correlation for flow over tube bank.
- Euler number per tube row.

When **Flow geometry** is set to Generic, the **Pressure loss model** parameter is disabled. Pressure loss is calculated empirically with the **Pressure loss coefficient, $\Delta p / (0.5 \cdot \rho \cdot v^2)$** parameter.

Pressure loss coefficient, $\Delta p / (0.5 \cdot \rho \cdot v^2)$ – Empirical loss coefficient for all pressure losses in the channel

10 (default) | positive scalar

Empirical loss coefficient for all pressure losses in the channel. This value accounts for wall friction and minor losses due to bends, elbows, and other geometry changes in the channel.

The loss coefficient can be calculated from a nominal operating condition or be tuned to fit experimental data. The coefficient is defined as:

$$\xi = \frac{\Delta p}{\frac{1}{2} \rho v^2}$$

where Δp is the pressure drop, ρ is the moist air density, and v is the flow velocity.

Dependencies

To enable this parameter, set either:

- **Flow geometry** to Generic.
- **Pressure loss model** to Pressure loss coefficient.

Aggregate equivalent length of local resistances – Combined length of all local resistances in the tubes

0.1 m (default) | positive scalar

Combined length of all local resistances in the tubes. This is the length of tubing that results in the same pressure losses as the sum of all minor losses in the tube due to such things as bends, tees, or unions. A longer equivalent length results in larger pressure losses.

Dependencies

To enable this parameter, set **Flow geometry** to Flow inside one or more tubes and **Pressure loss model** to Correlations for flow inside tubes.

Internal surface absolute roughness – Mean surface roughness height

15e-6 m (default) | positive scalar

Mean height of tube surface defects. A rougher wall results in larger pressure losses in the turbulent regime for pressure loss calculated with the Haaland correlation.

Dependencies

To enable this parameter, set **Flow geometry** to Flow inside one or more tubes and either:

- **Pressure loss model**
- **Heat transfer coefficient model**

to Correlation for flow inside tubes.

Laminar flow upper Reynolds number limit – Largest Reynolds number that indicates laminar flow

2000 (default) | positive scalar

Largest Reynolds number that indicates laminar flow. Between this value and the **Turbulent flow lower Reynolds number limit**, the flow regime is transitional.

Dependencies

To enable this parameter, set **Flow geometry** to Flow inside one or more tubes and **Pressure loss model** to Correlation for flow inside tubes.

Turbulent flow lower Reynolds number limit – Smallest Reynolds number that indicates turbulent flow

4000 (default) | positive scalar

Smallest Reynolds number that indicates turbulent flow. Between this value and the **Laminar flow upper Reynolds number limit**, the flow regime is transitional between the laminar and turbulent regimes.

Dependencies

To enable this parameter, set **Flow geometry** to Flow inside one or more tubes and **Pressure loss model** to Correlation for flow inside tubes.

Laminar friction constant for Darcy friction factor – Coefficient of pressure loss due to viscous friction in laminar flows

64 (default) | positive scalar

Coefficient in pressure loss equations for viscous friction in laminar flows. This parameter is also known as the *shape factor*. The default value corresponds to a circular tube cross-section.

Dependencies

To enable this parameter, set **Flow geometry** to Correlation for flow inside tubes, **Tube cross section** to Generic, and **Pressure loss model** to Correlation for flow inside tubes.

Heat transfer coefficient model – Method of calculating heat transfer coefficient between fluid and wall

Correlation for flow over tube bank (default) | Colburn equation | Correlation for flow inside tubes

Method of calculating the heat transfer coefficient between the fluid and the wall. The available settings are:

- Colburn equation. Use this setting to calculate the heat transfer coefficient with user-defined variables a , b , and c of the Colburn equation.
- Correlation for flow over tube bank. Use this setting to calculate the heat transfer coefficient based on the tube bank correlation using the Hagen number.
- Correlation for flow inside tubes. Use this setting to calculate the heat transfer coefficient for pipe flows with the Gnielinski correlation.

Dependencies

To enable this parameter, set **Flow geometry** to either:

- Flow perpendicular to bank of circular tubes .
- Flow inside one or more tubes.

Coefficients [a, b, c] for $a \cdot \text{Re}^b \cdot \text{Pr}^c$ — Colburn equation coefficients

[0.023, 0.8, 0.33] (default) | three-element vector

Three-element vector containing the empirical coefficients of the Colburn equation. The Colburn equation is a formulation for calculating the Nusselt Number. The general form of the Colburn equation is:

$$\text{Nu} = a \text{Re}^b \text{Pr}^c.$$

When the **Heat transfer coefficient model** is set to Colburn equation and **Flow geometry** is set to Flow inside one or more tubes, or **Flow geometry** is set to Generic, the default Colburn equation is:

$$\text{Nu} = 0.023 \text{Re}^{0.8} \text{Pr}^{1/3}.$$

When the **Heat transfer coefficient model** is set to Colburn equation and **Flow geometry** is set to Flow perpendicular to bank of circular tubes, the default Colburn equation is:

$$\text{Nu} = 0.27 \text{Re}^{0.63} \text{Pr}^{0.36}.$$

Dependencies

To enable this parameter, set:

1 Flow geometry to either:

- Flow inside one or more tubes
- Flow perpendicular to bank of circular tubes

and **Heat transfer coefficient model** to Colburn equation.

2 Flow geometry to Generic.

Laminar flow Nusselt number — Ratio of convective to conductive heat transfer in the laminar flow regime

3.66 (default) | positive scalar

Ratio of convective to conductive heat transfer in the laminar flow regime. The fluid Nusselt number influences the heat transfer rate and depends on the tube cross-section.

Dependencies

To enable this parameter, set **Flow geometry** to Flow inside one or more tubes, **Tube cross-section** to Generic, and **Heat transfer parameterization** to Correlation for flow inside tubes.

Tube bank grid arrangement — Geometrical placement of thermal liquid rows in the bank

InLine (default) | Staggered

Alignment of tubes in a tube bank. Rows are either in line with their neighbors, or staggered.

- InLine: All tube rows are located directly behind each other.

- **Staggered:** Tubes of the one tube row are located at the gap between tubes of the previous tube row.

Tube alignment influences the Nusselt number and the heat transfer rate.

Dependencies

To enable this parameter, set **Flow geometry** to Flow perpendicular to bank of circular tubes.

Number of tube rows along flow direction – Number of thermal liquid tube rows in the tube bank

5 (default) | positive scalar

Number of thermal liquid fluid tube rows in a tube bank. The rows are aligned with the direction of moist air flow.

Dependencies

To enable this parameter, set **Flow geometry** to Flow perpendicular to bank of circular tubes.

Number of tube segments in each tube row – Number of thermal liquid tubes in each row of the tube bank

5 (default) | positive scalar

Number of thermal liquid tubes in each row of a tube bank. This measurement is perpendicular to the moist air flow.

Dependencies

To enable this parameter, set **Flow geometry** to Flow perpendicular to bank of circular tubes.

Length of each tube segment in a tube row – Length of each thermal liquid tube

1 m (default) | positive scalar

Length of each thermal liquid tube that spans a tube row. All tubes in a tube bank are the same length.

Dependencies

To enable this parameter, set **Flow geometry** to Flow perpendicular to bank of circular tubes.

Tube outer diameter – Outer diameter of a single thermal liquid tube

0.05 m (default) | positive scalar

Outer diameter of a thermal liquid tube. The cross-section is uniform along a tube and so the diameter is constant throughout. This value influences the losses in the flow across a tube bank due to viscous friction.

Dependencies

To enable this parameter, set **Flow geometry** to Flow perpendicular to bank of circular tubes.

Longitudinal tube pitch (along flow direction) – Center-to-center distance between thermal liquid tube rows

0.15 m (default) | positive scalar

Distance between tube centers of the thermal liquid tube bank, aligned with the direction of flow of the moist air.

Dependencies

To enable this parameter, set **Flow geometry** to Flow perpendicular to bank of circular tubes.

Transverse tube pitch (perpendicular to flow direction) – Center-to-center distance between thermal liquid tubes in a row

0.15 m (default) | positive scalar

Distance between the tube centers in a row of thermal liquid tubes. This measurement is perpendicular to the moist air flow direction. See “Heat Transfer Coefficients” on page 1-956 for more information.

Dependencies

To enable this parameter, set **Flow geometry** to Flow perpendicular to bank of circular tubes.

Euler number per tube row, $\Delta p / (N \cdot 0.5 \cdot \rho \cdot v^2)$ – Euler number for each row of the tube bank

10 (default) | positive scalar

Empirical coefficient for pressure drop across one tube row. The Euler number is the ratio between pressure drop and fluid momentum:

$$Eu = \frac{\Delta p}{N \frac{1}{2} \rho v^2},$$

where N is the **Number of tube rows along flow direction**, Δp is the pressure drop, ρ is the moist air mixture density, and v is the flow velocity.

Each tube row is located in a plane perpendicular to the moist air flow.

Dependencies

To enable this parameter, set **Flow geometry** to Flow perpendicular to bank of circular tubes and **Pressure loss model** to Euler number per tube row.

Minimum free-flow area – Smallest total flow area between inlet and outlet0.01 m² (default) | positive scalar

Smallest total flow area between inlet and outlet. If the channel is a collection of ducts, tubes, slots, or grooves, the minimum free-flow area is the sum of the smallest areas.

Dependencies

To enable this parameter, set **Flow geometry** to Generic.

Heat transfer surface area without fins – Total area of the heat transfer surface excluding fins2 m² (default) | positive scalar

Total area of the heat transfer surface, excluding fins.

DependenciesTo enable this parameter, set **Flow geometry** to Generic.**Moist air volume inside heat exchanger – Total volume of moist air in the heat exchanger**0.05 m³ (default) | positive scalar

Total volume of moist air in the heat exchanger.

DependenciesTo enable this parameter, set **Flow geometry** to Generic.**Fouling factor – Additional thermal resistance due to fouling deposits**0.1 m²*K/kW (default) | positive scalar

Additional thermal resistance due to fouling layers on the surfaces of the wall. In real systems, fouling deposits grow over time. However, the growth is slow enough to be assumed constant during the simulation.

Total fin surface area – Total heat transfer surface area of all fins0 m² (default) | positive scalar

Total heat transfer surface area of both sides of all fins. For example, if the fin is rectangular, the surface area is double the area of the rectangle.

The total heat transfer surface area is the sum of the channel surface area and the effective fin surface area, which is the product of the **Fin efficiency** and the **Total fin surface area**.

Fin efficiency – Ratio of fin actual to idea heat transfer rates

0.5 (default) | positive scalar in the range [0,1]

Ratio of actual heat transfer to ideal heat transfer through the fins.

Initial moist air pressure – Moist air pressure at the start of simulation

0.101325 MPa (default) | positive scalar

Moist air pressure at the start of the simulation.

Initial moist air temperature – Temperature at the start of simulation

293.15 K (default) | positive scalar | two-element vector

Temperature in the moist air fluid channel at the start of the simulation. This parameter can be a scalar or a two-element vector. A scalar value represents the mean initial temperature in the channel. A vector value represents the initial temperature at the inlet and outlet in the form [inlet, outlet]. The block calculates a linear gradient between the two ports. The inlet and the outlet ports are identified according to the initial flow direction.

Initial moisture specification – Moisture specification

Relative humidity (default) | Specific humidity | Mole fraction | Humidity ratio

Moisture specification, which can be set as relative humidity, specific humidity, water vapor mole fraction, or humidity ratio.

Initial moist air relative humidity — Relative humidity at the start of simulation

0.5 (default) | positive scalar in the range of [0,1] | two-element vector

Relative humidity in the moist air channel at the start of the simulation. The relative humidity is the ratio of the water vapor partial pressure to the water vapor saturation pressure, or the ratio of the water vapor mole fraction to the water vapor mole fraction at saturation.

This parameter can be a scalar or a two-element vector. A scalar value represents the mean initial relative humidity in the channel. A vector value represents the initial relative humidity at the inlet and outlet in the form [inlet, outlet]. The block calculates a linear gradient between the two ports. The inlet and the outlet ports are identified according to the initial flow direction.

Dependencies

To enable this parameter, set **Initial moisture specification** to Relative humidity.

Initial moist air specific humidity — Specific humidity at the start of simulation

0.01 (default) | positive scalar in the range of [0,1] | two-element vector

Specific humidity in the moist air channel at the start of simulation. The specific humidity is the mass fraction of water vapor to the combined total mass of water vapor, trace gas, and dry air.

This parameter can be a scalar or a two-element vector. A scalar value represents the mean initial specific humidity in the channel. A vector value represents the initial specific humidity at the inlet and outlet in the form [inlet, outlet]. The block calculates a linear gradient between the two ports. The inlet and the outlet ports are identified according to the initial flow direction.

Dependencies

To enable this parameter, set **Initial moisture specification** to Specific humidity.

Initial moist air water vapor mole fraction — Mole fraction of water vapor at the start of simulation

0.01 (default) | positive scalar in the range [0,1] | two-element vector

Mole fraction of the water vapor in the moist air channel at the start of simulation. The water vapor mole fraction is relative to the combined molar quantity of water vapor, trace species, and dry air.

This parameter can be a scalar or a two-element vector. A scalar value represents the mean initial vapor mole fraction in the channel. A vector value represents the initial vapor mole fraction at the inlet and outlet in the form [inlet, outlet]. The block calculates a linear gradient between the two ports. The inlet and the outlet ports are identified according to the initial flow direction.

Dependencies

To enable this parameter, set **Initial moisture specification** to Mole fraction.

Initial moist air humidity ratio — Humidity ratio at the start of simulation

0.01 (default) | positive scalar in the range [0,1] | two-element vector

Humidity ratio in the moist air channel at the start of the simulation. The humidity ratio is the ratio of the mass of water vapor to the mass of dry air and trace gas.

This parameter can be a scalar or a two-element vector. A scalar value represents the mean initial humidity ratio in the channel. A vector value represents the initial humidity ratio at the inlet and outlet in the form [inlet, outlet]. The block calculates a linear gradient between the two ports. The inlet and the outlet ports are identified according to the initial flow direction.

Dependencies

To enable this parameter, set **Initial moisture specification** to Humidity ratio.

Initial trace gas specification – Measurement type of trace gas

Mass fraction (default) | Mole fraction

Measurement type of trace gas.

Initial moist air trace gas mass fraction – Amount of trace gas in the moist air channel

0.001 (default) | positive scalar in the range of [0,1] | two-element vector

Amount of trace gas in the moist air channel by mass fraction at the start of the simulation. The mass fraction is relative to the combined total mass of water vapor, trace gas, and dry air.

This parameter can be a scalar or a two-element vector. A scalar value represents the mean trace gas mass fraction in the channel. A vector value represents the initial trace gas mass fraction at the inlet and outlet in the form [inlet, outlet]. The block calculates a linear gradient between the two ports. The inlet and the outlet ports are identified according to the initial flow direction.

This parameter is ignored if the **Trace gas model** parameter in the Moist Air Properties (MA) block is set to None.

Dependencies

To enable this parameter, set **Initial trace gas specification** to Mass fraction.

Initial moist air trace gas mole fraction – Mole fraction of trace gas at the start of simulation

0.001 (default) | positive scalar in the range of [0,1] | two-element vector

Amount of trace gas in the moist air channel by mole fraction at the start of the simulation. The mole fraction is relative to the combined molar total of water vapor, trace gas, and dry air.

This parameter can be a scalar or a two-element vector. A scalar value represents the mean trace gas mole fraction in the channel. A vector value represents the initial trace gas mole fraction at the inlet and outlet in the form [inlet, outlet]. The block calculates a linear gradient between the two ports. The inlet and the outlet ports are identified according to the initial flow direction.

This parameter is ignored if the **Trace gas model** parameter in the Moist Air Properties (MA) block is set to None.

Dependencies

To enable this parameter, set **Initial trace gas specification** to Mole fraction.

Relative humidity at saturation – Relative humidity point of condensation

1 (default) | positive scalar in the range of [0,1]

Relative humidity point of condensation. Condensation occurs above this value. A value greater than 1 indicates a supersaturated vapor.

References

- [1] *2013 ASHRAE Handbook - Fundamentals*. American Society of Heating, Refrigerating and Air-Conditioning Engineers, Inc., 2013.
- [2] Braun, J. E., S. A. Klein, and J. W. Mitchell. "Effectiveness Models for Cooling Towers and Cooling Coils." *ASHRAE Transactions* 95, no. 2, (June 1989): 164-174.
- [3] Çengel, Yunus A. *Heat and Mass Transfer: A Practical Approach*. 3rd ed, McGraw-Hill, 2007.
- [4] Ding, X., Eppe J.P., Lebrun, J., Wasacz, M. "Cooling Coil Model to be Used in Transient and/or Wet Regimes. Theoretical Analysis and Experimental Validation." *Proceedings of the Third International Conference on System Simulation in Buildings* (1990): 405-411.
- [5] Mitchell, John W., and James E. Braun. *Principles of Heating, Ventilation, and Air Conditioning in Buildings*. Wiley, 2013.
- [6] Shah, R. K., and Dušan P. Sekulić. *Fundamentals of Heat Exchanger Design*. John Wiley & Sons, 2003.
- [7] White, Frank M. *Fluid Mechanics*. 6th ed, McGraw-Hill, 2009.

See Also

Condenser Evaporator (TL-2P) | Condenser Evaporator (2P-MA) | E-NTU Heat Transfer | Heat Exchanger (G-TL) | Heat Exchanger (TL-TL)

Introduced in R2020b

Isothermal Liquid Predefined Properties (IL)

Sets working fluid properties for an isothermal liquid network

Library: Simscape / Fluids / Isothermal Liquid / Utilities



Description

The Isothermal Liquid Predefined Properties (IL) block sets the working fluid liquid properties of your isothermal liquid network. The available predefined fluids are:

- “Water” on page 1-985
- “Seawater” on page 1-986
- “Ethylene-, Propylene-, and Glycerol-Water Mixtures” on page 1-985
- “Aviation Fuel Jet-A” on page 1-986
- “Diesel Fuel” on page 1-986
- “SAE 5W-30” on page 1-986

You can also model dissolved air in the system as a function of pressure. If you would like to specify your own working fluid properties, use the Foundation Library Isothermal Liquid Properties (IL) block. If you do not specify a fluid, the system defaults will apply. See “Specify Fluid Properties” for more details.

Fluid Properties Range

Water

Water properties are provided between the triple point, when the fluid temperature and pressure reach 273.160 K and 611.657 Pa, and the critical point, when the fluid temperature reaches 647.096 K. P_{\min} is set by the triple point or the saturation pressure, whichever is greater.

Ethylene-, Propylene-, and Glycerol-Water Mixtures

The properties for ethylene-glycol, propylene-glycol, and glycerol are provided for temperatures above the solution freezing point. Note that the displayed minimum temperature when visualizing properties may be lower than the fluid freezing point; displayed temperatures are not updated for different mixture concentrations.

When specifying the mixture, you can define the concentration of ethylene glycol, propylene glycol, or glycerol to water by mass fraction or volume fraction in the **Concentration type** parameter.

Properties are available for concentration by mass between 0 and 0.6 and by volume between 0 and 1 for ethylene glycol; for concentration by mass between 0 and 0.6 and by volume between 0.1 and 0.6 for propylene glycol; and for concentration by mass between 0 and 0.6 for glycerol. Glycerol concentration by volume is not available.

The properties are stored as a function of temperature and concentration. All properties, except for density and the thermal expansion coefficient α are maintained as constants for a range of pressures.

Seawater

Seawater properties are provided for temperatures between 273.15 K and 393.15 K and for pressures above the system saturation pressure. The salinity concentration can range from 0 to 0.12 by mass.

The properties are stored as tabulated data with respect to pressure and temperature. The data is derived from MIT's Seawater software. For more information, see: <https://web.mit.edu/seawater/>

Aviation Fuel Jet-A

The properties provided are for a general, representative fuel mixture based on Jet-A-4658 and Jet-A-3638 surrogates. The properties are provided at temperatures between 222.22 K and 645.61 K and pressures above the saturation point.

The properties are stored as tabulated data with respect to pressure and temperature.

Diesel Fuel

Diesel properties are provided for temperatures between 238.20 K and 690.97 K and for pressures above the saturation point.

SAE 5W-30

SAE 5W-30 properties are provided for temperatures between 235.15 K and 473.15 K and for pressures above 0.01 MPa.

Dissolved Air

You can optionally model air dissolved into the liquid system. Setting **Air dissolution model** to On models dissolution between **Atmospheric pressure** and the **Pressure at which all entrained air is dissolved** by Henry's law. For more information, see "Fluid Models with Entrained Air".

Visualizing Fluid Properties

To visualize the fluid density and bulk modulus in your network, right-click on the Isothermal Liquid Predefined Properties (IL) block and select **Fluids > Plot Fluid Properties**:

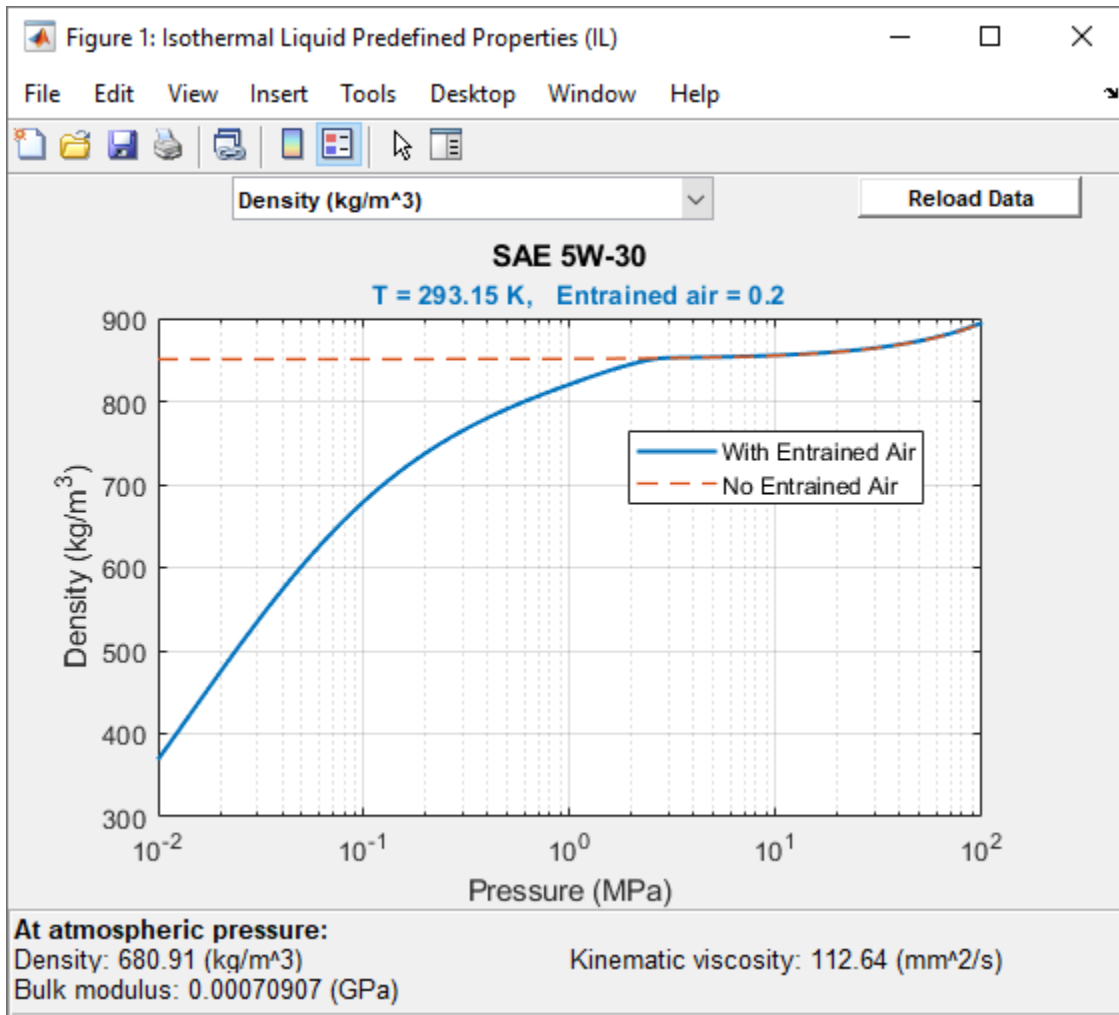

Use the **Reload Data** button to regenerate the plot whenever the fluid selection or fluid parameters change.

Ports

Conserving

A – Connection port

isothermal liquid

Isothermal liquid conserving port that connects the block to the network. This port connects to any point on an isothermal liquid connection line within a block diagram. When you connect the Isothermal Liquid Predefined Properties (IL) block to a network line, the liquid properties are propagated to all blocks in the circuit.

Parameters

Liquid

Isothermal liquid – Fluid choice

Water (default) | Seawater (MIT model) | Ethylene glycol and water mixture | Propylene glycol and water mixture | Glycerol and water mixture | Aviation fuel Jet-A | Diesel fuel | SAE 5W-30

Choice of working fluid in the system.

Dissolved salt mass fraction (salinity) – Salt concentration

3.5e-3 (default) | positive scalar between (0, 0.12]

Concentration of salt in water by mass.

Dependencies

To enable this parameter, set **Isothermal liquid** to Seawater (MIT).

Concentration type – Concentration by mass or volume

Volume fraction (default) | Mass fraction

Whether the solute is measured in water by mass or volume.

Dependencies

To enable this parameter, set **Isothermal liquid** to:

- Ethylene glycol and water mixture.
- Propylene glycol and water mixture.

Ethylene glycol volume fraction – Ethylene glycol concentration by volume

0.1 (default) | Positive scalar between (0, 1.0]

Fraction of ethylene glycol in water, by volume.

Dependencies

To enable this parameter, set **Isothermal liquid** to Ethylene glycol and water mixture and **Concentration type** to Volume fraction.

Ethylene glycol mass fraction – Ethylene glycol concentration by mass

0.1 (default) | positive scalar between (0, 0.6]

Fraction of ethylene glycol in water, by mass.

Dependencies

To enable this parameter, set **Isothermal liquid** to Ethylene glycol and water mixture and **Concentration type** to Mass fraction.

Isothermal bulk modulus at atmospheric pressure (no entrained air) – Bulk modulus

2.1791 GPa (default) | positive scalar

Solution bulk modulus at atmospheric pressure.

Dependencies

To enable this parameter, set **Isothermal liquid** to:

- Ethylene glycol and water mixture.
- Propylene glycol and water mixture.
- Glycerol and water mixture.

Minimum valid pressure — Lower pressure limit

0.01 (default) | positive scalar

Lower pressure limit during simulations. The **Atmospheric pressure** must greater than or equal to the **Minimum valid pressure**.

Dependencies

To enable this parameter, set **Isothermal liquid** to:

- Ethylene glycol and water mixture.
- Propylene glycol and water mixture.
- Glycerol and water mixture.

Propylene glycol volume fraction — Propylene glycol concentration by volume

0.1 (default) | positive scalar between [0.1, 0.6]

Fraction of propylene glycol in water, by volume.

Dependencies

To enable this parameter, set **Isothermal liquid** to Propylene glycol and water mixture and **Concentration type** to Volume fraction.

Propylene glycol mass fraction — Propylene glycol concentration by mass

0.1 (default) | positive scalar between (0, 0.6]

Fraction of propylene glycol in water, by mass.

Dependencies

To enable this parameter, set **Isothermal liquid** to Propylene glycol and water mixture and **Concentration type** to Mass fraction.

Glycerol mass fraction — Glycerol concentration by mass

0.1 (default) | positive scalar between (0, 0.6]

Fraction of glycerol in water, by mass.

Dependencies

To enable this parameter, set **Isothermal liquid** to Glycerol and water mixture.

System temperature — Network temperature

300 K (default) | positive scalar

Isothermal liquid network temperature.

Viscosity derating factor – Viscosity correction factor

1 (default) | positive scalar

Correction factor for fluids diverging from the clean fluid standard viscosity.

Atmospheric pressure – User-defined environmental pressure

0.101325 MPa (default) | positive scalar

Environmental pressure of the system.

Entrained Air**Volumetric fraction of air that is entrained at atmospheric pressure – System air entrainment at atmospheric pressure**

0 (default) | positive scalar

Air entrainment in fluid network at atmospheric pressure.

Air polytropic index – Polytropic process exponent

1.0 (default) | positive scalar between [0, 1]

Exponent of the equation that governs the polytropic process relating fluid pressure and volume.

Air density at atmospheric condition – Air density1.225 kg/m³ (default) | positive scalar

Air density at the pressure defined in the **Atmospheric pressure** parameter.

Air dissolution model – Air entrainment model

On (default) | Off

Whether to account for of air dissolution into the fluid network. Air dissolution into the liquid is modeled between the **Atmospheric pressure** and the **Pressure at which all entrained air is dissolved** by Henry's Law.

Pressure at which all entrained air is dissolved – Upper pressure limit for air entrainment

3 MPa (default) | positive scalar

Upper pressure limit for air entrainment into the fluid.

Dependencies

To enable this parameter, set **Air dissolution model** to On.

References

- [1] Massachusetts Institute of Technology (MIT), *Thermophysical properties of seawater database*. <http://web.mit.edu/seawater>.
- [2] K.G. Nayar, M.H. Sharqawy, L.D. Banchik, J.H. Lienhard V. "Thermophysical properties of seawater: A review and new correlations that include pressure dependence." *Desalination* 390 (July 2016): 1-24.

- [3] M.H. Sharqawy, J.H. Lienhard V, S.M. Zubair. "Thermophysical properties of seawater: A review of existing correlations and data." *Desalination and Water Treatment* 16, no. 1-3 (april 2010): 354-380.
- [4] I.H. Bell, J. Wronski, S. Quoilin, V. Lemort. "Pure and Pseudo-pure Fluid Thermophysical Property Evaluation and the Open-Source Thermophysical Property Library CoolProp." *Industrial & Engineering Chemistry Research* 53, no. 6 (February 12, 2014): 2498-2508.

See Also

Isothermal Liquid Properties (IL) | "Isothermal Liquid Modeling Options"

Topics

"Fluid Models with Entrained Air"

Introduced in R2020a

Hydraulic Fluid

Working fluid properties, set by selecting from list of predefined fluids



Library

Hydraulic Utilities

Description

The Hydraulic Fluid block lets you specify the type of hydraulic fluid used in a loop of hydraulic blocks. It provides the hydraulic fluid properties, such as kinematic viscosity, density, and bulk modulus, for all the hydraulic blocks in the loop. These fluid properties are assumed to be constant during simulation time. The density is determined by the type of fluid, while kinematic viscosity additionally requires that the temperature is specified.

The bulk modulus value shown in the block dialog box is the bulk modulus of pure liquid, and is determined by the type of fluid and by the temperature. When the fluid properties are used in hydraulic blocks, such as Constant Volume Hydraulic Chamber or Variable Hydraulic Chamber, the fluid is represented as a mixture of liquid and a small amount of entrained, nondissolved gas, which is specified in the Hydraulic Fluid block as **Relative amount of trapped air**. The mixture bulk modulus in these blocks is determined as:

$$E = E_l \frac{1 + \alpha \left(\frac{p_a}{p_a + p} \right)^{1/n}}{1 + \alpha \frac{p_a^{1/n}}{n \cdot (p_a + p)^{\frac{n+1}{n}}} E_l}$$

where

E_l	Pure liquid bulk modulus
p_a	Atmospheric pressure
α	Relative gas content at atmospheric pressure, $\alpha = V_G/V_L$
V_G	Gas volume at atmospheric pressure
V_L	Volume of liquid
n	Gas-specific heat ratio

The main objective of representing fluid as a mixture of liquid and gas is to introduce an approximate model of cavitation, which takes place in a chamber if pressure drops below fluid vapor saturation level. As it is seen in the graph below, the bulk modulus of a mixture decreases at $p \rightarrow p_a$, thus considerably slowing down further pressure change. At high pressure, $p \gg p_a$, a small amount of nondissolved gas has practically no effect on the system behavior.

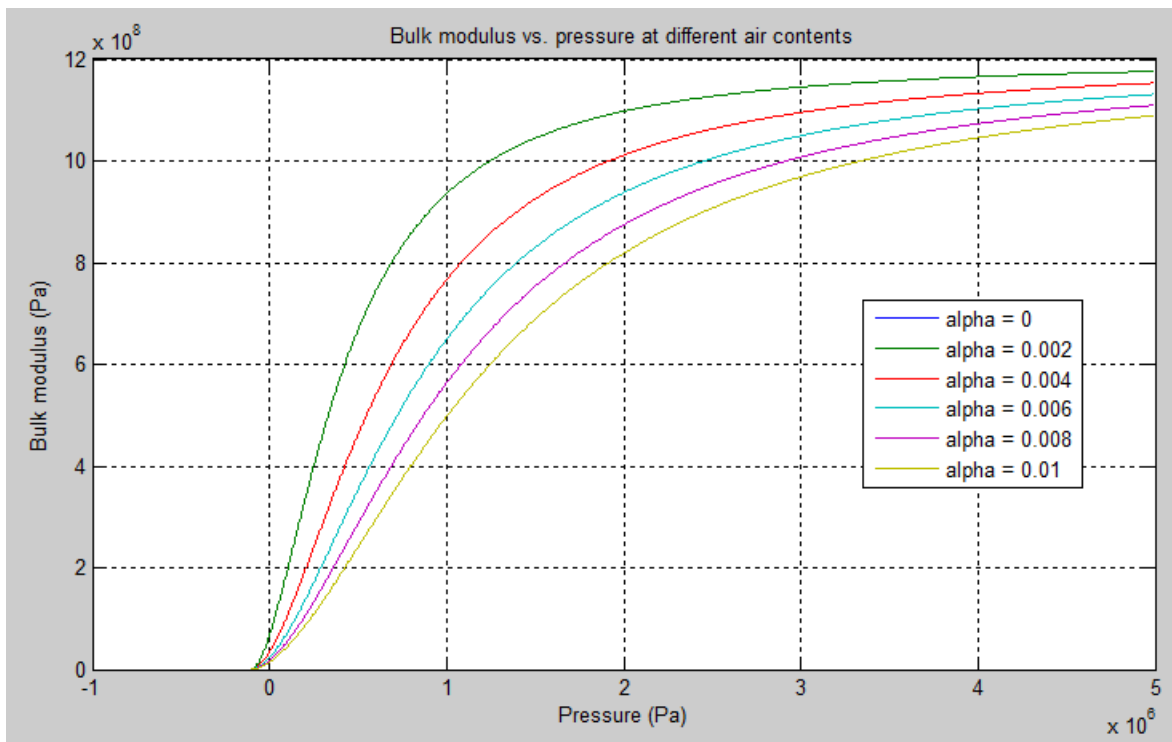

Cavitation is an inherently thermodynamic process, requiring consideration of multiple-phase fluids, heat transfers, and so on, and as such cannot be accurately simulated with Simscape Fluids software. But the simplified version implemented in the block is good enough to signal if pressure falls below dangerous level, and to prevent computation failure that normally occurs at negative pressures.

The Hydraulic Fluid block offers a selection of predefined fluids. See “Examples” on page 1-995 for how you can get information on the fluid properties used in the block. Once you select a fluid name, you can also specify the temperature of the fluid and the relative amount of entrained, nondissolved gas.

The Hydraulic Fluid block has one port. You can connect it to a hydraulic diagram by branching a connection line off the main line and connecting it to the port. When you connect the Hydraulic Fluid block to a hydraulic line, the software automatically identifies the hydraulic blocks connected to the particular loop and propagates the hydraulic fluid properties to all the hydraulic blocks in the loop.

Each topologically distinct hydraulic loop in a diagram requires the properties of its working fluid to be specified. You can specify these properties either by selecting a predefined fluid using a Hydraulic Fluid block, or by specifying parameters of a custom fluid using a Custom Hydraulic Fluid block, which is available in the Simscape Foundation library. If no Hydraulic Fluid block or Custom Hydraulic Fluid block is attached to a loop, the hydraulic blocks in this loop use the default fluid, which is equivalent to fluid defined by a Custom Hydraulic Fluid block with the default parameter values.

Parameters

Hydraulic fluid

Hydraulic fluid type. Select one of the predefined fluids:

- Skydrol LD-4 (default)
- Skydrol 500B-4
- Skydrol-5
- HyJet-4A
- Fluid MIL-F-83282
- Fluid MIL-F-5606
- Fluid MIL-F-87257
- Oil-10W
- Oil-30W
- Oil-50W
- Oil SAE-30
- Oil SAE-50
- Transmission fluid ATF (Dexron III)
- ISO VG 22 (ESSO UNIVIS N 22)
- ISO VG 32 (ESSO UNIVIS N 32)
- ISO VG 46 (ESSO UNIVIS N 46)
- Brake fluid DOT3
- Brake fluid DOT4
- Brake fluid DOT5
- Gasoline
- Diesel fuel
- Jet fuel
- Water-Glycol 60/40
- Water

Relative amount of trapped air

Amount of entrained, nondissolved gas in the fluid. The amount is specified as the ratio of gas volume at normal conditions to the fluid volume in the chamber. Therefore, the parameter value must be less than 1. In practice, the relative amount of trapped air is always greater than 0. If set to 0, ideal fluid is assumed. The default value is 0.005.

System temperature

Fluid temperature (C). The default value is 60.

Viscosity derating factor

Proportionality coefficient that you can use to adjust fluid viscosity, if needed. Specify a value between 0.5 and 1.5. The default value is 1.

Pressure below absolute zero

Determines how the block handles the out-of-range assertion during simulation:

- **Error** — If the pressure falls below absolute zero, the simulation stops and you get an error message. This is the default.
- **Warning** — If the pressure falls below absolute zero, you get a warning but the simulation continues. Use this option when modeling systems where cavitation can occur in extreme cases.

Restricted Parameters

When your model is in Restricted editing mode, you cannot modify the following parameters:

- **Hydraulic fluid**
- **Pressure below absolute zero**

All other block parameters are available for modification.

Ports

The block has one hydraulic conserving port.

Examples

You can get information on the fluids and their properties through the MATLAB command line. In the following example, the first command brings you the list of available fluids, and the second command plots the properties of a selected fluid from the list, in this case, Skydrol LD-4.

- 1 In the MATLAB Command Window, type:

```
props = sh_stockfluidproperties
```

The system responds with a list of available fluids:

```
props =
    skydrol_ld_4: [1x1 struct]
    skydrol_500_4: [1x1 struct]
    skydrol_5: [1x1 struct]
    hy_jet: [1x1 struct]
    f_83282: [1x1 struct]
    f_5606: [1x1 struct]
    f_87257: [1x1 struct]
    oil_10w: [1x1 struct]
    oil_30w: [1x1 struct]
    oil_50w: [1x1 struct]
    oil_sae_30: [1x1 struct]
    oil_sae_50: [1x1 struct]
    atf_dexron: [1x1 struct]
    iso_vg_32: [1x1 struct]
    gasoline: [1x1 struct]
    diesel_fuel: [1x1 struct]
    jet_fuel: [1x1 struct]
    water_glycol: [1x1 struct]
```

- 2 To plot the properties of the first fluid in the list, Skydrol LD-4, type:

```
props.skydrol_ld_4.plot()
```

The plot window opens:

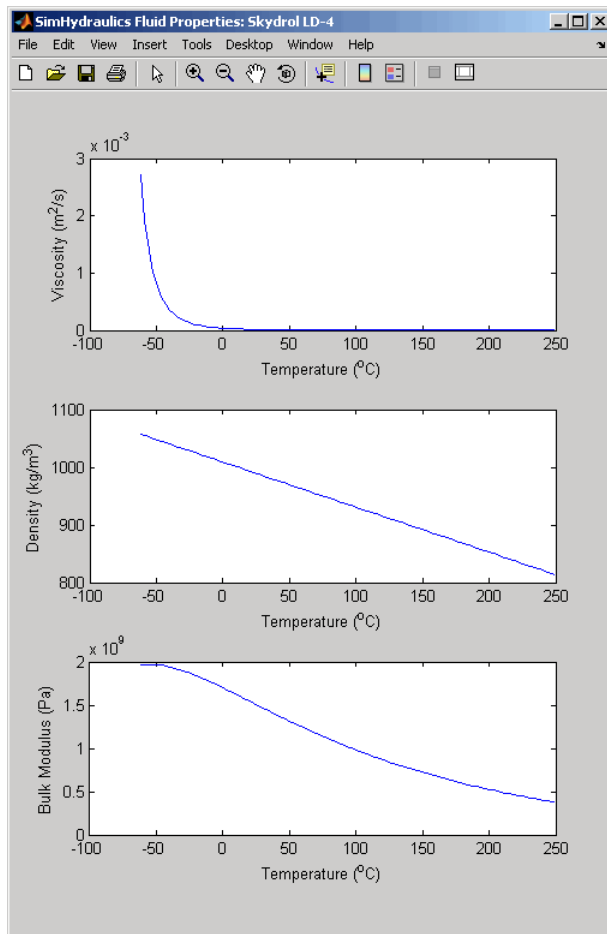

Fluid properties for the Skydrol family of hydraulic fluids were obtained from literature provided by the manufacturer, Solutia, Inc. More information is available on their website at: <http://www.skydrol.com>.

Extended Capabilities

C/C++ Code Generation

Generate C and C++ code using Simulink® Coder™.

See Also

Custom Hydraulic Fluid

Topics

“Upgrading Simscape Fluids Models Containing Hydraulics (Isothermal) Blocks”

Introduced in R2006a

Fan (MA)

Fan in moist air network

Library: Simscape / Fluids / Moist Air / Turbomachinery



Description

The Fan (MA) block represents a fan in a moist air network. You can model the torque and pressure gain over the fan as a function of static pressure and flow rate or by using 1D or 2D tabulated reference pressure, shaft speed, and flow rate data.

By default, flow and pressure gain are from port **A** to port **B**. Port **C** represents the fan casing, and port **R** represents the fan shaft. You can specify the normal operating shaft direction in the **Mechanical orientation** parameter. If the shaft begins to spin in the opposite direction, the pressure difference across the fan drops to zero.

Parameterization by Nominal Pressure, Flow Rate, and Shaft Speed

When you set the **Fan parameterization** parameter to Static pressure and flow rate at reference shaft speed, the block uses the analytical fan affinity laws and reference pressure differential to calculate the pressure gain from port **A** to port **B**:

$$p_B - p_A = \Delta p_{ref} \left(\frac{\omega}{\omega_{ref}} \right)^2 \left(\frac{D}{D_{ref}} \right)^2,$$

where:

- Δp_{ref} is the reference pressure differential. The block uses a quadratic fit of the fan pressure differential values at the **Maximum static pressure gain at zero flow**, **Nominal static pressure gain**, and **Maximum volumetric flow rate at zero pressure** parameters.
- ω is the shaft angular velocity, $\omega_R - \omega_C$.
- ω_{ref} is the **Reference shaft speed** parameter.
- $\frac{D}{D_{ref}}$ is the **Fan diameter scale factor** parameter.

The block calculates the shaft torque from the reference mechanical power and the fan affinity laws:

$$\tau = \Phi_{ref} \frac{\omega^2}{\omega_{ref}^3} \left(\frac{D}{D_{ref}} \right)^5.$$

Where Φ_{ref} is the proportion of the pressure gain to the fan efficiency:

$$\Phi_{ref} = \frac{q_{ref} \Delta p_{ref}}{\eta_{ref}}.$$

When you set the **Shaft power specification** parameter to Fan efficiency, the block uses a quadratic fit of efficiency between the fan peak performance, η_{nom} , and 0. η_{nom} is equivalent to the

Nominal efficiency parameter, which the block interprets as the peak efficiency. If you set the **Shaft power specification** parameter to Brake power, the block derives the nominal fan efficiency from the nominal brake power, Φ_{nom} , at peak or nominal conditions:

$$\eta_{nom} = \frac{q_{nom}\Delta p_{nom}}{\Phi_{nom}}.$$

The block assumes the efficiency is zero when there is no flow or when the flow reaches the maximum volumetric flow rate at zero pressure. The block uses the current flow q to compute the reference flow rate as:

$$q_{ref} = q \frac{\omega_{ref}}{\omega} \left(\frac{D_{ref}}{D} \right)^3.$$

1-D Tabulated Data Parameterization: Pressure as a Function of Flow Rate at Reference Shaft Speed

When you set the **Fan parameterization** parameter to 1D tabulated data - static pressure vs. flow rate at reference shaft speed, you can model fan performance as a function of volumetric flow rate. The block interpolates the pressure gain from port **A** to port **B** from the 1-D **Static pressure gain vector** parameter, $\Delta p_{ref}(q_{ref})$:

$$p_B - p_A = \Delta p_{ref}(q_{ref}) \left(\frac{\rho}{\rho_{ref}} \right) \left(\frac{\omega}{\omega_{ref}} \right)^2 \left(\frac{D}{D_{ref}} \right)^2.$$

Here, ρ is the moist air density, and ρ_{ref} is the reference density, which is equivalent to the **Reference density** parameter. The block calculates the shaft torque from the reference mechanical power and the fan affinity laws:

$$\tau = \Phi_{ref}(q_{ref}) \frac{\omega^2}{\omega_{ref}^3} \left(\frac{\rho}{\rho_{ref}} \right) \left(\frac{D}{D_{ref}} \right)^5,$$

where ρ_{ref} is the **Reference density**.

The block uses the current flow q to compute the reference flow rate:

$$q_{ref} = q \frac{\omega_{ref}}{\omega} \left(\frac{D_{ref}}{D} \right)^3.$$

When the simulation is outside of the normal fan operating conditions, the block linearly extrapolates the reference pressure and extrapolates the reference torque to its nearest neighbor.

2-D Tabulated Data Parameterization: Pressure as a Function of Shaft Speed and Flow Rate

When you set the **Fan parameterization** parameter to 2D tabulated data - static pressure vs. shaft speed and flow rate, you can model fan performance as a 2-D function of volumetric flow rate and angular velocity. The block interpolates the pressure gain from port **A** to port **B** from the 2-D **Static pressure gain table**, $\mathbf{dp}(\mathbf{w}, \mathbf{q})$ parameter. The block defines the reference pressure gain, $\Delta p_{ref}(q_{ref}, \omega)$, as

$$p_B - p_A = \Delta p_{ref}(q_{ref}, \omega) \left(\frac{\rho}{\rho_{ref}} \right) \left(\frac{D}{D_{ref}} \right)^2.$$

The block calculates shaft torque from the reference mechanical power and the fan affinity laws:

$$\tau = \frac{\Phi_{ref}(\Delta p_{ref}, \omega)}{\omega} \left(\frac{\rho}{\rho_{ref}} \right) \left(\frac{D}{D_{ref}} \right)^5,$$

where the reference mechanical power is a function of the reference flow rate and the current shaft speed.

The block uses the current flow q to compute the reference flow rate:

$$q_{ref} = q \left(\frac{D_{ref}}{D} \right)^3.$$

When the simulation is outside of the normal fan operating conditions, the block linearly extrapolates the reference pressure and extrapolates the reference torque to its nearest neighbor.

2-D Tabulated Data Parameterization: Flow Rate as a Function of Shaft Speed and Pressure

When you set the **Fan parameterization** parameter to 2D tabulated data - flow rate vs. shaft speed and static pressure, you can model the flow rate through the fan as a 2-D function of pressure and angular velocity. The volumetric flow rate is interpolated from the 2-D **Volumetric flow rate table, $q(\mathbf{w}, \mathbf{dp})$** parameter, q_{ref} . The reference flow rate is a function of the reference pressure gain, Δp_{ref} , and the current shaft speed, ω :

$$q = q_{ref}(\Delta p_{ref}, \omega) \left(\frac{D}{D_{ref}} \right)^3,$$

where the reference pressure gain derives from the pressure differential over the fan:

$$\Delta p_{ref} = (p_B - p_A) \left(\frac{\rho_{ref}}{\rho} \right) \left(\frac{D_{ref}}{D} \right)^2.$$

The shaft torque derives from the reference mechanical power and the fan affinity laws:

$$\tau = \frac{\Phi_{ref}(\Delta p_{ref}, \omega)}{\omega} \left(\frac{\rho}{\rho_{ref}} \right) \left(\frac{D}{D_{ref}} \right)^5,$$

where the reference mechanical power is a function of the reference flow rate and the current shaft speed.

When the simulation is outside of the normal fan operating conditions, the block linearly extrapolates the reference pressure and extrapolates the reference torque to its nearest neighbor.

Power and Efficiency

You can specify shaft power as either fan efficiency or brake power.

The block calculates efficiency as

$$\eta = \frac{\Phi_{fluid}}{\Phi_{brake}},$$

where the *brake power*, or mechanical power measured at the shaft, is

$$\Phi_{brake} = \tau\omega.$$

The block calculates fluid power as

$$\Phi_{fluid} = q(p_B - p_A).$$

The block calculates torque as

$$\tau = \frac{\Phi_{brake}}{\omega}.$$

Visualizing the Fan Curve

You can check the parameterized fan performance by plotting the pressure, power, efficiency, and torque as a function of the flow. To generate a plot of the current pump settings, right-click on the block and select **Fluids > Plot Fan Characteristics**. If you change settings or data, click **Apply** on the block parameters and click **Reload Data** on the pump curve figure.

The default block parameterization results in these plots:

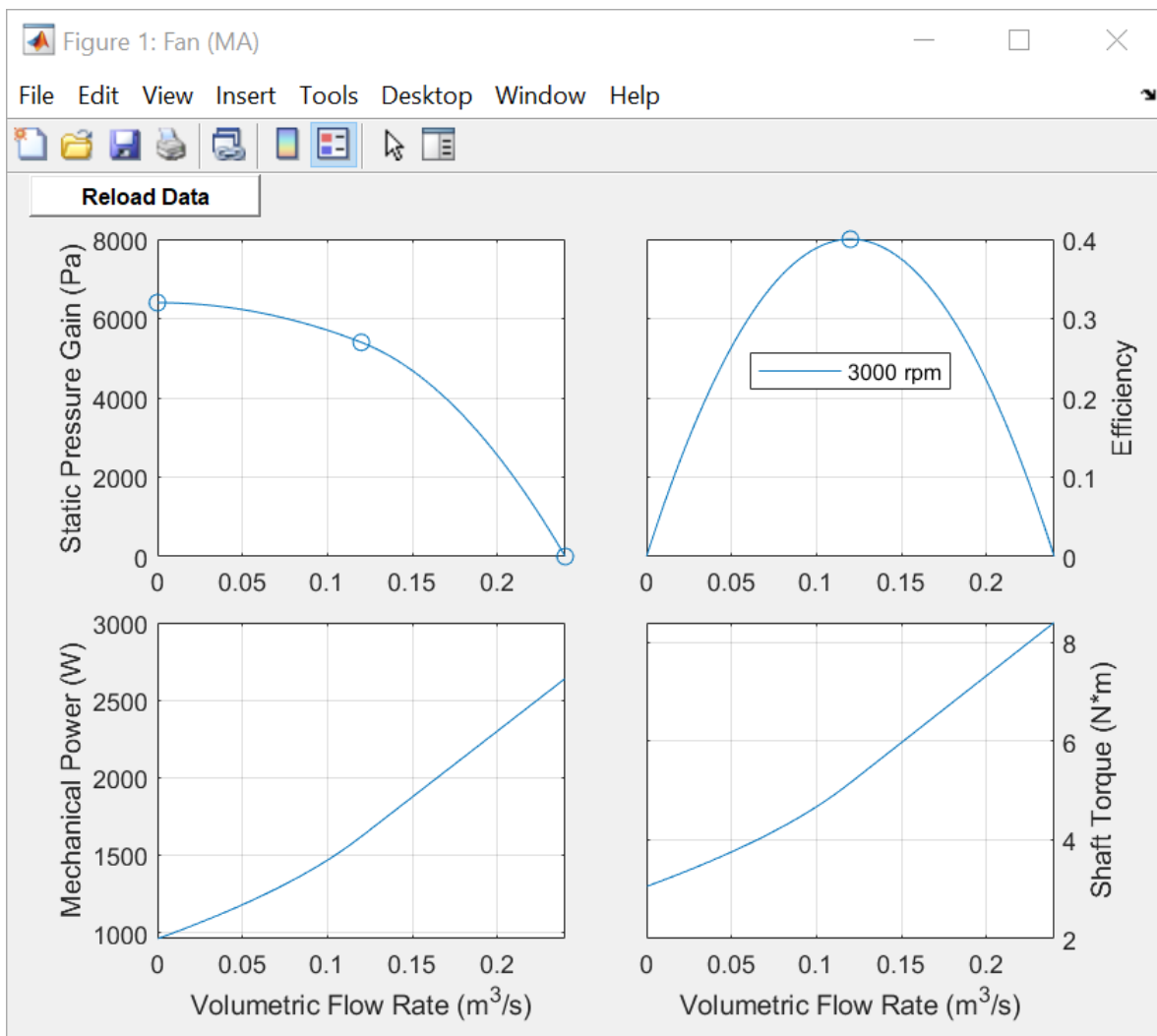

Assumptions and Limitations

- Reverse flow or a pressure drop over the fan is not normal operation, and the simulation results in these situations may not be accurate.
- The block assumes that the fan is quasi-steady.
- The block simulates fan performance in terms of static pressure rise, and not total fan pressure.

Ports

Conserving

A – Fluid entry

moist air

Moist air conserving port associated with the fluid.

B – Fluid exit

moist air

Moist air conserving port associated with the fluid.

R – Shaft

mechanical rotational

Mechanical rotational conserving port associated with the shaft.

C – Casing

mechanical rotational

Mechanical rotational conserving port associated with the casing.

Parameters

Fan parameterization – Fan performance model

Static pressure and flow rate at reference shaft speed (default) | 1D tabulated data - static pressure vs. flow rate at reference shaft speed | 2D tabulated data - static pressure vs. shaft speed and flow rate | 2D tabulated data - flow rate vs. shaft speed and static pressure

Fan performance model.

- Static pressure and flow rate at reference shaft speed - Specify fan performance based on typical, nominal, or rated pressure gain and volumetric flow rate.
- 1D tabulated data – static pressure vs flow rate at reference shaft speed - Specify fan performance based on interpolation of pressure gain data as a function of volumetric flow rate.
- 2D tabulated data – static pressure vs shaft speed and flow rate - Specify fan performance based on interpolation of pressure gain data as a function of shaft speed and volumetric flow rate.
- 2D tabulated data – flow rate vs shaft speed and static pressure - Specify fan performance based on interpolation of volumetric flow rate data as a function of shaft speed and pressure gain.

Shaft power specification – Power definition

Fan efficiency (default) | Brake power

Fan power specification.

- Fan efficiency - Derive the mechanical power from the fan efficiency.
- Mechanical power - Specify the mechanical power directly.

Nominal volumetric flow rate – Flow rate at reference shaft speed0.12 m³/s (default) | positive scalar

Volumetric flow rate through the fan at the reference shaft speed under nominal, typical, or rated operating conditions.

DependenciesTo enable this parameter, set **Fan parameterization** to Static pressure and flow rate at reference shaft speed.**Nominal static pressure gain – Pressure gain at reference shaft speed**

5400 Pa (default) | positive scalar

Pressure increase from port **A** to port **B** at the reference shaft speed under nominal, typical, or rated operating conditions.**Dependencies**To enable this parameter, set **Fan parameterization** to Static pressure and flow rate at reference shaft speed.**Nominal efficiency – Efficiency at reference shaft speed**

0.40 (default) | positive scalar

Efficiency of converting the shaft power to fluid power at the reference shaft speed under nominal, typical, or rated operating conditions.

Dependencies

To enable this parameter, set:

- **Fan parameterization** to Static pressure and flow rate at reference shaft speed.
- **Shaft power specification** to Fan efficiency.

Nominal mechanical power – Power at nominal efficiency

1620 W (default) | positive scalar

Mechanical power driving moist air flow at the reference shaft speed under nominal, typical, or rated operating conditions.

Dependencies

To enable this parameter, set:

- **Fan parameterization** to Static pressure and flow rate at reference shaft speed.
- **Shaft power specification** to Brake power.

Maximum static pressure gain at zero flow – Maximum pressure at reference shaft speed

6400 Pa (default) | positive scalar

Pressure increase from port **A** to port **B** at the reference shaft speed when there is no flow through the fan.

Dependencies

To enable this parameter, set **Fan parameterization** to Static pressure and flow rate at reference shaft speed.

Maximum volumetric flow rate at zero pressure – Maximum flow rate at reference shaft speed0.24 m³/s (default) | positive scalar

Free-delivery volumetric flow rate at the reference shaft speed and constant pressure.

Dependencies

To enable this parameter, set **Fan parameterization** to Static pressure and flow rate at reference shaft speed.

Reference shaft speed – Fan curve reference speed

3000 rpm (default) | positive scalar

Reference shaft angular velocity corresponding to the fan characteristic curve data.

Dependencies

To enable this parameter, set **Fan parameterization** to Static pressure and flow rate at reference shaft speed.

Volumetric flow rate vector – Fan curve flow rate vector[.0278, .0556, .0833, .111, .139, .167] m³/s (default) | vector

Vector of volumetric flow rate grid points for the 1-D interpolation of the fan characteristic curve.

Dependencies

To enable this parameter, set **Fan parameterization** to 1D tabulated data - static pressure vs. flow rate at reference shaft speed.

Static pressure gain vector – Pressure gain for given volumetric flow rate

[6410, 6375, 6018, 5366, 4501, 3609] Pa (default) | vector

Vector of pressure gain data points. Each element in the vector corresponds to an element in the **Volumetric flow rate vector** parameter. The pressure gain is the increase in pressure from port **A** to port **B** at the reference shaft speed.

Dependencies

To enable this parameter, set **Fan parameterization** to 1D tabulated data - static pressure vs. flow rate at reference shaft speed.

Efficiency vector – Efficiency for given volumetric flow rate

[.257, .394, .453, .47, .459, .415] (default) | vector

Vector of fan efficiency data points. Each element in the vector corresponds to an element in the **Volumetric flow rate vector** parameter. The efficiency is the ratio of fluid power to shaft mechanical power at the reference shaft speed.

Dependencies

To enable this parameter, set **Fan parameterization** to 1D tabulated data - static pressure vs. flow rate at reference shaft speed and **Shaft power specification** to Fan efficiency.

Mechanical power vector — Power for parameterization of torque

[693, 900, 1107, 1267, 1363, 1452] W (default) | 1-by- n vector

Vector of shaft mechanical power data points. Each element in the vector corresponds to an element in the **Volumetric flow rate vector** parameter. The mechanical power is the power that drives the fan at the reference shaft speed.

Dependencies

To enable this parameter, set **Fan parameterization** to 1D tabulated data - static pressure vs. flow rate at reference shaft speed and **Shaft power specification** to Brake power.

Reference density — Density associated with fan curve data

1.2 kg/m³ (default) | positive scalar

Moist air density for a given characteristic fan curve.

Shaft speed vector, w — Shaft angular velocity for given

[2400; 3000; 3600] rpm (default) | vector

Vector of shaft angular velocity grid points for the 2-D interpolation of the fan characteristic curves.

Dependencies

To enable this parameter, set **Fan parameterization** to 2D tabulated data - static pressure vs. shaft speed and flow rate.

Volumetric flow rate vector, q — Flow rate for parameterization of pressure gain

[.0278, .0556, .0833, .111, .139, .167] m³/s (default) | 1-by- n vector

Vector of volumetric flow rate grid points for the 2-D interpolation of the fan characteristic curves.

Dependencies

To enable this parameter, set **Fan parameterization** to 2D tabulated data - static pressure vs. shaft speed and flow rate.

Static pressure gain table, $dp(w,q)$ — Pressure for parameterization of pressure

[4111, 4010, 3551, 2881, 2167, 1453; 6410, 6375, 6018, 5366, 4501, 3609; 9217, 9285, 9022, 8428, 7552, 6482] Pa (default) | M -by- N matrix

M -by- N matrix of pressure gain data points for the 2-D interpolation of the pressure gain. The pressure gain is the increase in pressure from port **A** to port **B**. M and N are the sizes of the corresponding vectors:

- M is the number of elements in the **Shaft speed vector, w** parameter. The elements in the first column must be in strictly ascending order.
- N is the number of elements in the **Volumetric flow rate vector, q** parameter.

Dependencies

To enable this parameter, set **Fan parameterization** to 2D tabulated data - static pressure vs. shaft speed and flow rate.

Efficiency table, $\eta(w,q)$ – Efficiency for parameterization of torque

[.3, .434, .468, .459, .4, .3; .257, .394, .453, .47, .459, .415; .225, .359, .434, .461, .47, .459] 1 (default) | M -by- N matrix

M -by- N matrix of efficiency data points for the 2-D interpolation of torque. The efficiency is the ratio of fluid power to shaft mechanical power. M and N are the sizes of the corresponding vectors:

- M is the number of elements in the **Shaft speed vector, w** parameter.
- N is the number of elements in the **Volumetric flow rate vector, q** parameter.

Dependencies

To enable this parameter, set **Fan parameterization** to 2D tabulated data - static pressure vs. shaft speed and flow rate and **Shaft power specification** to Fan efficiency.

Mechanical power table, $W(w,q)$ – Mechanical power for parameterization of torque

[381, 514, 632, 697, 753, 809; 693, 900, 1107, 1267, 1363, 1452; 1139, 1438, 1732, 2029, 2233, 2358] W (default) | M -by- N matrix

M -by- N table of mechanical power data points for the 2-D interpolation of torque. The mechanical power is the power that drives the fan. M and N are the sizes of the corresponding vectors:

- M is the number of elements in the **Shaft speed vector, w** parameter. Elements in the first column must be in strictly ascending order.
- N is the number of elements in the **Volumetric flow rate vector, q** parameter.

Dependencies

To enable this parameter, set **Fan parameterization** to 2D tabulated data - static pressure vs. shaft speed and flow rate and **Shaft power specification** to Brake power.

Shaft speed vector, w – Shaft speed for parameterization of flow rate

[2990; 3450; 3867] rpm (default) | M -by-1 vector

Vector of shaft angular velocity grid points for the 2-D interpolation of the fan characteristic curves.

Dependencies

To enable this parameter, set **Fan parameterization** to 2D tabulated data - flow rate vs. shaft speed and static pressure.

Static pressure gain vector, dp – Pressure for parameterization of flow rate

[31, 62, 93, 124] Pa (default) | 1-by- N vector

Vector of pressure gain grid points for the 2-D interpolation of the fan characteristic curves.

Dependencies

To enable this parameter, set **Fan parameterization** to 2D tabulated data - flow rate vs. shaft speed and static pressure.

Volumetric flow rate table, $q(w, dp)$ – Flow rate for parameterization of flow rate

[.802, .759, .703, .611; .936, .902, .862, .81; 1.056, 1.027, .994, .956]
 m^3/s (default) | M -by- N matrix

M -by- N matrix of volumetric flow rate data points for the 2-D interpolation of volumetric flow rate. M and N are the sizes of the corresponding vectors:

- M is the number of elements in the **Shaft speed vector, w** parameter.
- N is the number of elements in the **Static pressure gain vector, Dp** parameter.

Dependencies

To enable this parameter, set **Fan parameterization** to 2D tabulated data - flow rate vs. shaft speed and static pressure.

Efficiency table, $\eta(w, dp)$ – Efficiency for parameterization of torque

[.088, .162, .22, .261; .068, .128, .18, .222; .055, .105, .148, .188] (default)
 | M -by- N matrix

M -by- N matrix of efficiency data points for the 2-D interpolation of torque. The efficiency is the ratio of fluid power to shaft mechanical power. M and N are the sizes of the corresponding vectors:

- M is the number of elements in the **Shaft speed vector, w** parameter.
- N is the number of elements in the **Static pressure gain vector, Dp** parameter.

Dependencies

To enable this parameter, set **Fan parameterization** to 2D tabulated data - flow rate vs. shaft speed and static pressure and **Shaft power specification** to Fan efficiency.

Mechanical power table, $W(w, dp)$ – Mechanical power for parameterization of torque

[283, 290, 297, 290; 427, 437, 445, 452; 595, 606, 625, 631] W (default) | M -by- N matrix

M -by- N matrix of mechanical power data points for the 2-D interpolation of torque. The mechanical power is the power that drives the fan. M and N are the sizes of the corresponding vectors:

- M is the number of elements in the **Shaft speed vector, w** parameter. The elements in the first column must be in strictly ascending order.
- N is the number of elements in the **Static pressure gain vector, Dp** parameter.

Dependencies

To enable this parameter, set **Fan parameterization** to 2D tabulated data - flow rate vs. shaft speed and static pressure and **Shaft power specification** to Brake power.

Fan diameter scale factor – Model-to-reference scale factor

1 (default) | positive scalar

Geometric scale factor to increase or decrease the size of the simulated fan from the given fan parameterization. The scaling may not be accurate for scale factors much larger or much smaller than 1.

Mechanical orientation – Rotational orientation

Positive angular velocity of port R relative to port C corresponds to normal fan operation (default) | Negative angular velocity of port R relative to port C corresponds to normal fan operation

Normal operating shaft direction. By default, flow and pressure gain are from port **A** to port **B**.

Inlet flow area (port A) – Port A area

0.01 m² (default) | positive scalar

Cross-sectional area of the moist air flow at the fan inlet.

Outlet flow area (port B) – Port B area

0.01 m² (default) | positive scalar

Cross-sectional area of the moist air flow at the fan outlet.

Extended Capabilities**C/C++ Code Generation**

Generate C and C++ code using Simulink® Coder™.

See Also

Fan (G)

Introduced in R2021b

Hydraulic Pipeline

Hydraulic pipeline with resistive and fluid compressibility properties



Library

Pipelines

Description

The Hydraulic Pipeline block models hydraulic pipelines with circular and noncircular cross sections. The block accounts for friction loss along the pipe length and for fluid compressibility. The block does not account for fluid inertia and cannot be used for predicting effects like water hammer or changes in pressure caused by fluid acceleration.

The model is built of Simscape Foundation library building blocks and its schematic diagram is shown below.

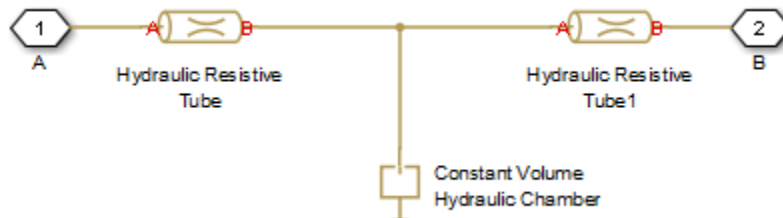

The Hydraulic Resistive Tube blocks account for friction losses, while the Constant Volume Hydraulic Chamber block accounts for fluid compressibility. By using the block parameters, you can set the model to simulate pipeline with rigid or flexible walls, including simulation of hydraulic hoses with elastic and viscoelastic properties.

The block positive direction is from port A to port B. This means that the flow rate is positive if it flows from A to B, and the pressure loss is determined as $p = p_A - p_B$.

Basic Assumptions and Limitations

- Flow is assumed to be fully developed along the pipe length.
- Fluid inertia is not taken into account.

Parameters

Pipe cross section type

The type of pipe cross section: `Circular` or `Noncircular`. For a circular pipe, you specify its internal diameter. For a noncircular pipe, you specify its hydraulic diameter and pipe cross-sectional area. The default value of the parameter is `Circular`.

Pipe internal diameter

Pipe internal diameter. The parameter is used if **Pipe cross section type** is set to `Circular`. The default value is `0.01` m.

Noncircular pipe cross-sectional area

Pipe cross-sectional area. The parameter is used if **Pipe cross section type** is set to `Noncircular`. The default value is `1e-4` m².

Noncircular pipe hydraulic diameter

Hydraulic diameter of the pipe cross section. The parameter is used if **Pipe cross section type** is set to `Noncircular`. The default value is `0.0112` m.

Geometrical shape factor

Used for computing friction factor at laminar flow. The shape of the pipe cross section determines the value. For a pipe with a noncircular cross section, set the factor to an appropriate value, for example, 56 for a square, 96 for concentric annulus, 62 for rectangle (2:1), and so on. The default value is 64, which corresponds to a pipe with a circular cross section.

Pipe length

Pipe geometrical length. The default value is 5 m.

Aggregate equivalent length of local resistances

This parameter represents total equivalent length of all local resistances associated with the pipe. You can account for the pressure loss caused by local resistances, such as bends, fittings, armature, inlet/outlet losses, and so on, by adding to the pipe geometrical length an aggregate equivalent length of all the local resistances. This length is added to the geometrical pipe length only for hydraulic resistance computation. The fluid volume depends on pipe geometrical length only. The default value is 1 m.

Internal surface roughness height

Roughness height on the pipe internal surface. The parameter is typically provided in data sheets or manufacturer's catalogs. The default value is `15e-6` m, which corresponds to drawn tubing.

Laminar flow upper margin

Specifies the Reynolds number at which the laminar flow regime is assumed to start converting into turbulent. Mathematically, this is the maximum Reynolds number at fully developed laminar flow. The default value is 2000.

Turbulent flow lower margin

Specifies the Reynolds number at which the turbulent flow regime is assumed to be fully developed. Mathematically, this is the minimum Reynolds number at turbulent flow. The default value is 4000.

Pipe wall type

The parameter is available only for circular pipes and can have one of two values: `Rigid Wall` or `Flexible Wall`. If the parameter is set to `Rigid Wall`, wall compliance is not taken into account, which can improve computational efficiency. The value `Flexible Wall` is recommended for hoses and metal pipes where wall compliance can affect the system behavior. The default value is `Rigid Wall`.

Static pressure-diameter coefficient

Coefficient that establishes relationship between the pressure and the internal diameter at steady-state conditions. This coefficient can be determined analytically for cylindrical metal pipes or experimentally for hoses. The parameter is used if the **Pipe wall type** parameter is set to **Flexible Wall**. The default value is $2e-12$ m/Pa.

Viscoelastic process time constant

Time constant in the transfer function that relates pipe internal diameter to pressure variations. By using this parameter, the simulated elastic or viscoelastic process is approximated with the first-order lag. The value is determined experimentally or provided by the manufacturer. The parameter is used if the **Pipe wall type** parameter is set to **Flexible Wall**. The default value is 0.01 s.

Specific heat ratio

Gas-specific heat ratio for the Constant Volume Hydraulic Chamber block. The default value is 1.4.

Initial pressure

Initial pressure in the pipe. This parameter specifies the initial condition for use in computing the block's initial state at the beginning of a simulation run. For more information, see "Initial Conditions Computation". The default value is 0.

Restricted Parameters

When your model is in Restricted editing mode, you cannot modify the following parameters:

- **Pipe cross section type**
- **Pipe wall type**

All other block parameters are available for modification. The actual set of modifiable block parameters depends on the values of the **Pipe cross section type** and **Pipe wall type** parameters at the time the model entered Restricted mode.

Global Parameters

Parameters determined by the type of working fluid:

- **Fluid density**
- **Fluid kinematic viscosity**

Use the Hydraulic Fluid block or the Custom Hydraulic Fluid block to specify the fluid properties.

Ports

The block has the following ports:

A

Hydraulic conserving port associated with the pipe inlet.

B

Hydraulic conserving port associated with the pipe outlet.

References

[1] White, F.M., *Viscous Fluid Flow*, McGraw-Hill, 1991

Extended Capabilities

C/C++ Code Generation

Generate C and C++ code using Simulink® Coder™.

See Also

Linear Hydraulic Resistance | Hydraulic Resistive Tube | Segmented Pipeline

Topics

“Upgrading Simscape Fluids Models Containing Hydraulics (Isothermal) Blocks”

Introduced in R2006a

Hydraulic Pipe LP

Hydraulic pipeline with resistive, fluid compressibility, and elevation properties



Library

Low-Pressure Blocks

Description

The Hydraulic Pipe LP block models hydraulic pipelines with circular and noncircular cross sections. The block accounts for friction loss along the pipe length and for fluid compressibility. The block does not account for fluid inertia and cannot be used for predicting effects like water hammer or changes in pressure caused by fluid acceleration.

The model is a structural model and its schematic diagram is shown below.

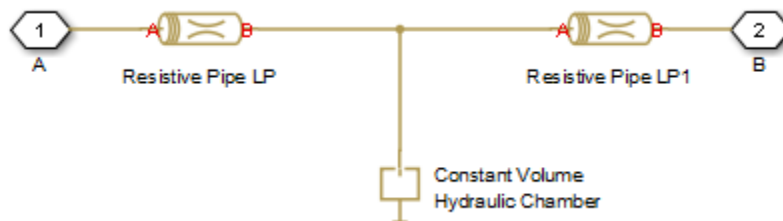

The Resistive Pipe LP blocks account for friction losses, while the Constant Volume Hydraulic Chamber block accounts for fluid compressibility. To reduce model complexity, you can use this block to simulate not only a pipe itself, but also a combination of pipes and local resistances such as bends, fittings, inlet and outlet losses, associated with the pipe. You must convert the resistances into their equivalent lengths, and then sum up all the resistances to obtain their aggregate length. Then add this length to the pipe geometrical length. By using the block parameters, you can set the model to simulate pipeline with rigid or flexible walls, including simulation of hydraulic hoses with elastic and viscoelastic properties.

The difference in elevation between ports A and B is distributed evenly between pipe segments.

The block positive direction is from port A to port B. This means that the flow rate is positive if it flows from A to B, and the pressure loss is determined as $p = p_A - p_B$.

Basic Assumptions and Limitations

- Flow is assumed to be fully developed along the pipe length.

- Fluid inertia is not taken into account.

Parameters

- “Basic Parameters Tab” on page 1-1013
- “Wall Compliance Tab” on page 1-1014
- “Vertical Position Tab” on page 1-1014

Basic Parameters Tab

Pipe cross section type

The type of pipe cross section: **Circular** or **Noncircular**. For a circular pipe, you specify its internal diameter. For a noncircular pipe, you specify its hydraulic diameter and pipe cross-sectional area. The default value of the parameter is **Circular**.

Pipe internal diameter

Pipe internal diameter. The parameter is used if **Pipe cross section type** is set to **Circular**. The default value is 0.01 m.

Noncircular pipe cross-sectional area

Pipe cross-sectional area. The parameter is used if **Pipe cross section type** is set to **Noncircular**. The default value is $1e-4 \text{ m}^2$.

Noncircular pipe hydraulic diameter

Hydraulic diameter of the pipe cross section. The parameter is used if **Pipe cross section type** is set to **Noncircular**. The default value is 0.0112 m.

Geometrical shape factor

Used for computing friction factor at laminar flow. The shape of the pipe cross section determines the value. For a pipe with a noncircular cross section, set the factor to an appropriate value, for example, 56 for a square, 96 for concentric annulus, 62 for rectangle (2:1), and so on. The default value is 64, which corresponds to a pipe with a circular cross section.

Pipe length

Pipe geometrical length. The default value is 5 m.

Aggregate equivalent length of local resistances

This parameter represents total equivalent length of all local resistances associated with the pipe. You can account for the pressure loss caused by local resistances, such as bends, fittings, armature, inlet/outlet losses, and so on, by adding to the pipe geometrical length an aggregate equivalent length of all the local resistances. This length is added to the geometrical pipe length only for hydraulic resistance computation. The fluid volume depends on pipe geometrical length only. The default value is 1 m.

Internal surface roughness height

Roughness height on the pipe internal surface. The parameter is typically provided in data sheets or manufacturer’s catalogs. The default value is $15e-6 \text{ m}$, which corresponds to drawn tubing.

Laminar flow upper Reynolds number

Specifies the Reynolds number at which the laminar flow regime is assumed to start converting into turbulent. Mathematically, this is the maximum Reynolds number at fully developed laminar flow. The default value is 2000.

Turbulent flow lower Reynolds number

Specifies the Reynolds number at which the turbulent flow regime is assumed to be fully developed. Mathematically, this is the minimum Reynolds number at turbulent flow. The default value is 4000.

Initial pressure

Gauge pressure in the pipe at time zero. The default value is 0 Pa.

Wall Compliance Tab**Pipe wall type**

The parameter is available only for circular pipes and can have one of two values: **Rigid** or **Flexible**. If the parameter is set to **Rigid**, wall compliance is not taken into account, which can improve computational efficiency. The value **Flexible** is recommended for hoses and metal pipes where wall compliance can affect the system behavior. The default value is **Rigid**.

Static pressure-diameter coefficient

Coefficient that establishes relationship between the pressure and the internal diameter at steady-state conditions. This coefficient can be determined analytically for cylindrical metal pipes or experimentally for hoses. The parameter is used if the **Pipe wall type** parameter is set to **Flexible**. The default value is $2e-12$ m/Pa.

Viscoelastic process time constant

Time constant in the transfer function that relates pipe internal diameter to pressure variations. By using this parameter, the simulated elastic or viscoelastic process is approximated with the first-order lag. The value is determined experimentally or provided by the manufacturer. The parameter is used if the **Pipe wall type** parameter is set to **Flexible**. The default value is 0.01 s.

Specific heat ratio

Gas-specific heat ratio for the Constant Volume Hydraulic Chamber block. The default value is 1.4. If **Pipe cross section type** is set to **Noncircular**, then this is the only parameter on the Wall Compliance tab.

Vertical Position Tab**Port A elevation from reference plane**

Vertical position of port **A** with respect to a reference plane. The reference plane is assumed to be the same as that used in the **Port B elevation from reference plane** parameter. The default value is 0m.

Port B elevation from reference plane

Vertical position of port **B** with respect to a reference plane. The reference plane is assumed to be the same as that used in the **Port A elevation from reference plane** parameter. The default value is 0m.

Gravitational acceleration

Value of the gravitational acceleration constant (g). The block uses this value to compute the pressure differential between the ports due to a change in elevation. The default value is 9.80665 m/s².

Restricted Parameters

When your model is in Restricted editing mode, you cannot modify the following parameters:

- **Pipe cross section type**
- **Pipe wall type**

All other block parameters are available for modification. The actual set of modifiable block parameters depends on the values of the **Pipe cross section type** and **Pipe wall type** parameters at the time the model entered Restricted mode.

Global Parameters

Parameters determined by the type of working fluid:

- **Fluid density**
- **Fluid kinematic viscosity**

Use the Hydraulic Fluid block or the Custom Hydraulic Fluid block to specify the fluid properties.

Ports

The block has the following ports:

A

Hydraulic conserving port associated with the pipe inlet.

B

Hydraulic conserving port associated with the pipe outlet.

References

[1] White, F.M., *Viscous Fluid Flow*, McGraw-Hill, 1991

Extended Capabilities

C/C++ Code Generation

Generate C and C++ code using Simulink® Coder™.

See Also

Hydraulic Pipeline | Hydraulic Pipe LP with Variable Elevation | Linear Hydraulic Resistance | Resistive Pipe LP | Resistive Pipe LP with Variable Elevation | Hydraulic Resistive Tube | Segmented Pipeline | Segmented Pipe LP

Topics

“Upgrading Simscape Fluids Models Containing Hydraulics (Isothermal) Blocks”

Introduced in R2009a

Hydraulic Pipe LP with Variable Elevation

Hydraulic pipeline with resistive, fluid compressibility, and variable elevation properties



Library

Low-Pressure Blocks

Description

The Hydraulic Pipe LP with Variable Elevation block models hydraulic pipelines with circular and noncircular cross sections. The block accounts for friction loss along the pipe length and for fluid compressibility. The block does not account for fluid inertia and cannot be used for predicting effects like water hammer or changes in pressure caused by fluid acceleration. Use this block for low-pressure system simulation in which the pipe ends change their positions with respect to the reference plane. The elevations are provided through respective physical signal inputs.

The model is a structural model and its schematic diagram is shown below.

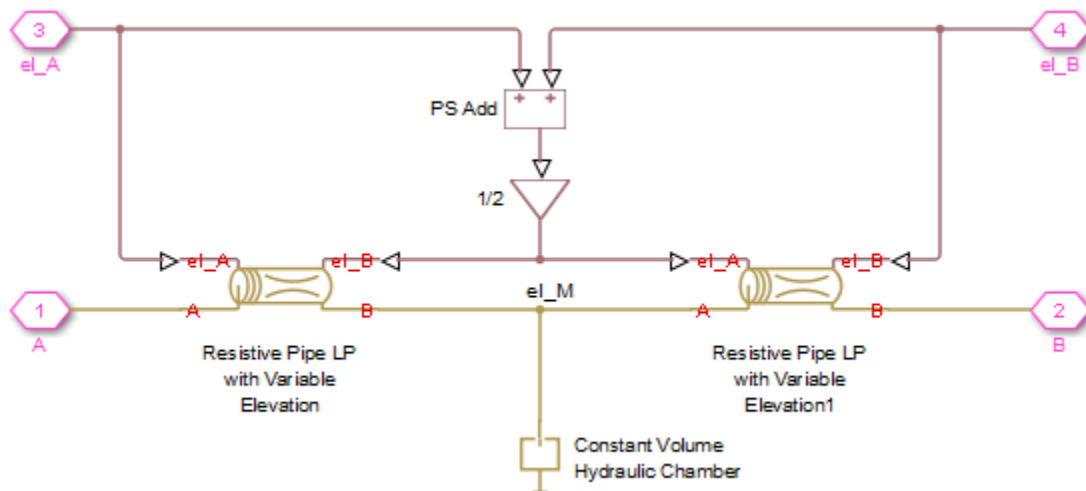

The Resistive Pipe LP with Variable Elevation blocks account for friction losses, while the Constant Volume Hydraulic Chamber block accounts for fluid compressibility. To reduce model complexity, you can use this block to simulate not only a pipe itself, but also a combination of pipes and local resistances such as bends, fittings, inlet and outlet losses, associated with the pipe. You must convert the resistances into their equivalent lengths, and then sum up all the resistances to obtain their aggregate length. Then add this length to the pipe geometrical length. By using the block

parameters, you can set the model to simulate pipeline with rigid or flexible walls, including simulation of hydraulic hoses with elastic and viscoelastic properties.

The difference in elevation between ports A and B is assumed to be distributed evenly between pipe segments. Thus, the elevation of the pipe middle point is computed as

$$el_M = \frac{el_A + el_B}{2}$$

where

el_M	Elevation of the pipe middle point
el_A, el_B	Elevations of the pipe ends A and B, respectively

The block positive direction is from port A to port B. This means that the flow rate is positive if it flows from A to B, and the pressure loss is determined as $p = p_A - p_B$.

Basic Assumptions and Limitations

- Flow is assumed to be fully developed along the pipe length.
- Fluid inertia is not taken into account.
- The pipe elevation is distributed evenly along the pipe length.

Parameters

- “Basic Parameters Tab” on page 1-1017
- “Wall Compliance Tab” on page 1-1018

Basic Parameters Tab

Pipe cross section type

The type of pipe cross section: **Circular** or **Noncircular**. For a circular pipe, you specify its internal diameter. For a noncircular pipe, you specify its hydraulic diameter and pipe cross-sectional area. The default value of the parameter is **Circular**.

Pipe internal diameter

Pipe internal diameter. The parameter is used if **Pipe cross section type** is set to **Circular**. The default value is 0.01 m.

Noncircular pipe cross-sectional area

Pipe cross-sectional area. The parameter is used if **Pipe cross section type** is set to **Noncircular**. The default value is $1e-4 \text{ m}^2$.

Noncircular pipe hydraulic diameter

Hydraulic diameter of the pipe cross section. The parameter is used if **Pipe cross section type** is set to **Noncircular**. The default value is 0.0112 m.

Geometrical shape factor

Used for computing friction factor at laminar flow. The shape of the pipe cross section determines the value. For a pipe with a noncircular cross section, set the factor to an appropriate value, for example, 56 for a square, 96 for concentric annulus, 62 for rectangle (2:1), and so on. The default value is 64, which corresponds to a pipe with a circular cross section.

Pipe length

Pipe geometrical length. The default value is 5 m.

Aggregate equivalent length of local resistances

This parameter represents total equivalent length of all local resistances associated with the pipe. You can account for the pressure loss caused by local resistances, such as bends, fittings, armature, inlet/outlet losses, and so on, by adding to the pipe geometrical length an aggregate equivalent length of all the local resistances. This length is added to the geometrical pipe length only for hydraulic resistance computation. The fluid volume depends on pipe geometrical length only. The default value is 1 m.

Internal surface roughness height

Roughness height on the pipe internal surface. The parameter is typically provided in data sheets or manufacturer's catalogs. The default value is $1.5e-5$ m, which corresponds to drawn tubing.

Laminar flow upper Reynolds number limit

Specifies the Reynolds number at which the laminar flow regime is assumed to start converting into turbulent. Mathematically, this is the maximum Reynolds number at fully developed laminar flow. The default value is 2000.

Turbulent flow lower Reynolds number limit

Specifies the Reynolds number at which the turbulent flow regime is assumed to be fully developed. Mathematically, this is the minimum Reynolds number at turbulent flow. The default value is 4000.

Gravitational acceleration

Value of the gravitational acceleration constant (g). The block uses this parameter to calculate time changes in pressure due to time changes in elevation. The default value is 9.80665 m/s^2 .

Initial pressure

Gauge pressure in the pipe at time zero. The default value is 0 Pa.

Wall Compliance Tab**Pipe wall type**

The parameter is available only for circular pipes and can have one of two values: **Rigid** or **Flexible**. If the parameter is set to **Rigid**, wall compliance is not taken into account, which can improve computational efficiency. The value **Flexible** is recommended for hoses and metal pipes where wall compliance can affect the system behavior. The default value is **Rigid**.

Static pressure-diameter coefficient

Coefficient that establishes relationship between the pressure and the internal diameter at steady-state conditions. This coefficient can be determined analytically for cylindrical metal pipes or experimentally for hoses. The parameter is used if the **Pipe wall type** parameter is set to **Flexible**. The default value is $2e-12 \text{ m/Pa}$.

Viscoelastic process time constant

Time constant in the transfer function that relates pipe internal diameter to pressure variations. By using this parameter, the simulated elastic or viscoelastic process is approximated with the first-order lag. The value is determined experimentally or provided by the manufacturer. The parameter is used if the **Pipe wall type** parameter is set to **Flexible**. The default value is 0.01 s.

Specific heat ratio

Gas-specific heat ratio for the Constant Volume Hydraulic Chamber block. The default value is 1.4. If **Pipe cross section type** is set to *Noncircular*, then this is the only parameter on the Wall Compliance tab.

Global Parameters

Parameters determined by the type of working fluid:

- **Fluid density**
- **Fluid kinematic viscosity**

Use the Hydraulic Fluid block or the Custom Hydraulic Fluid block to specify the fluid properties.

Ports

The block has the following ports:

A

Hydraulic conserving port associated with the pipe inlet.

B

Hydraulic conserving port associated with the pipe outlet.

e1_A

Physical signal input port that controls pipe elevation at port A.

e1_B

Physical signal input port that controls pipe elevation at port B.

Examples

For an example of using this block, see the “Aircraft Fuel Supply System with Three Tanks” example.

References

[1] White, F.M., *Viscous Fluid Flow*, McGraw-Hill, 1991

Extended Capabilities**C/C++ Code Generation**

Generate C and C++ code using Simulink® Coder™.

See Also

Hydraulic Pipeline | Hydraulic Pipe LP | Hydraulic Resistive Tube | Linear Hydraulic Resistance | Resistive Pipe LP | Resistive Pipe LP with Variable Elevation | Segmented Pipeline | Segmented Pipe LP

Topics

“Upgrading Simscape Fluids Models Containing Hydraulics (Isothermal) Blocks”

Introduced in R2010a

Hydraulic Single-Acting Valve Actuator

Single-acting hydraulic valve actuator



Library

Valve Actuators

Description

Use the Hydraulic Single-Acting Valve Actuator block as a pilot actuator for directional, pressure, or flow control valves in applications where all the forces, except spring force, and flow consumption can be neglected.

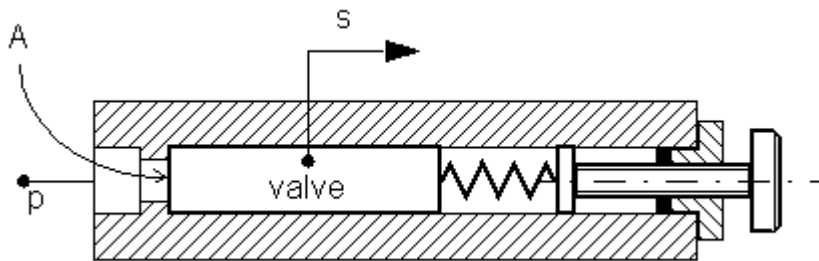

The actuator consists of a piston and a spring. The spring, which can be preloaded, tends to keep the piston at the initial position. As pressure applied to the piston develops enough force to overcome the spring preload, the piston moves to the opposite position until it reaches its maximum stroke.

The actuator is simulated according to the following equations:

$$F = p \cdot A$$

$$L = \frac{\text{stroke}}{F_{\max} - F_{pr}}$$

$$s = \begin{cases} 0 & \text{for } F < = F_{pr} \\ L \cdot (F - F_{pr}) \cdot \text{or} & \text{for } F_{pr} < F < F_{\max} \\ \text{stroke} \cdot \text{or} & \text{for } F > = F_{\max} \end{cases}$$

where

p	Pressure applied to the piston
-----	--------------------------------

s	Piston displacement
A	Piston area
F	Instantaneous spring force
F_{pr}	Spring preload force
F_{max}	Spring force at maximum piston displacement
<i>stroke</i>	Piston stroke
<i>or</i>	Actuator orientation with respect to the globally assigned positive direction. If pressure applied at port X moves the piston in positive direction, <i>or</i> equals 1. If pressure applied at port X moves the piston in negative direction, <i>or</i> equals -1.

Connection X is a hydraulic conserving port associated with the valve chamber. Connection P is a physical signal port whose output corresponds to piston displacement. Pressure applied at port X moves the piston in the positive or negative direction, depending on the value of the **Actuator orientation** parameter.

Basic Assumptions and Limitations

- No loading, such as inertia, friction, hydraulic force, and so on, is taken into account. The only force considered is a spring force.
- No flow consumption associated with the piston motion, leakage, or fluid compressibility is taken into account.

Parameters

Piston area

Effective piston area. The default value is $2e-4 \text{ m}^2$.

Preload force

Spring preload force. The default value is 20 N.

Full stroke force

Force necessary to move the piston to maximum stroke. The default value is 70 N.

Piston stroke

Piston stroke. The default value is $5e-3 \text{ m}$.

Actuator orientation

Specifies actuator orientation with respect to the globally assigned positive direction. The actuator can be installed in two different ways, depending upon whether it moves the piston in the positive or in the negative direction when pressure is applied at its inlet. If pressure applied at port X moves the piston in the negative direction, set the parameter to `Acts in negative direction`. The default value is `Acts in positive direction`.

Restricted Parameters

When your model is in Restricted editing mode, you cannot modify the following parameter:

- **Actuator orientation**

All other block parameters are available for modification.

Ports

The block has the following ports:

X

Hydraulic conserving port associated with the valve chamber.

P

Physical signal port that outputs piston displacement.

Examples

The following example shows a model of a pressure-relief valve built using the Hydraulic Single-Acting Valve Actuator and Orifice with Variable Area Round Holes blocks.

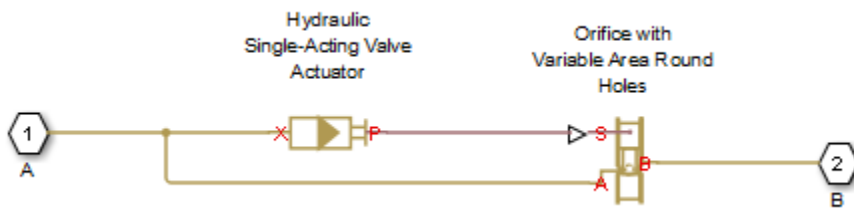

Extended Capabilities

C/C++ Code Generation

Generate C and C++ code using Simulink® Coder™.

See Also

2-Position Valve Actuator | 3-Position Valve Actuator | Hydraulic Double-Acting Valve Actuator | Proportional and Servo-Valve Actuator

Introduced in R2007a

Hydraulically Operated Remote Control Valve

Normally closed or normally open hydraulically operated remote control valve



Library

Directional Valves

Description

The Hydraulically Operated Remote Control Valve block represents a hydraulically operated remote control valve as a data-sheet-based model, meaning that most of the model parameters are generally available in catalogs or manufacturer data sheets. Hydraulically operated remote control valves are widely used in hydraulic systems as hydraulic switches, unloading and sequencing valves. You can also use them as pressure-relief and pressure-reducing valves. The block covers both the normally closed and normally open configurations, shown in the following figure.

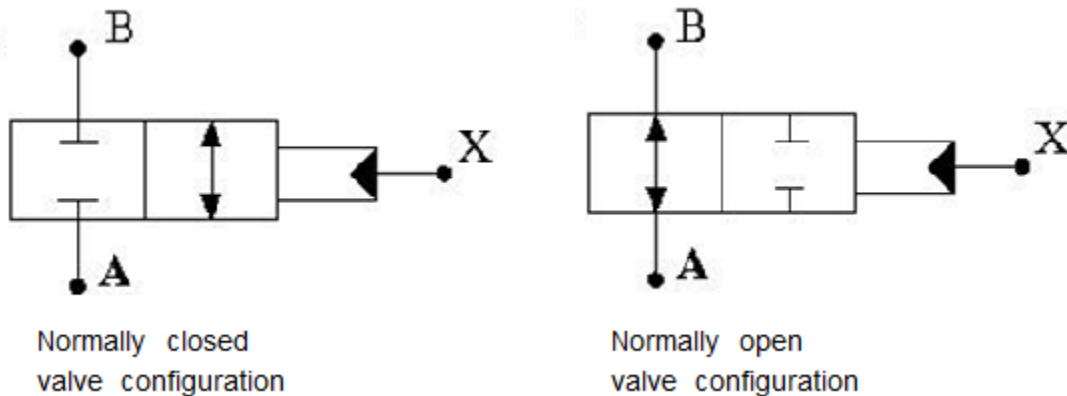

The valve opens (closes) by the pilot pressure. The valve control member remains in its initial position as long as the pilot pressure is lower than the cracking pressure. When cracking pressure is reached, the valve control member (spool, ball, poppet, and so on) is forced off its seat and starts opening the normally closed valve, or closing the normally open valve. The control member displacement is directly proportional to pilot pressure. The member reaches its maximum displacement after the pilot pressure becomes equal or greater than the preset maximum value. The valve maximum area, cracking pressure, and maximum pressure are the key parameters of the block. These three parameters are usually provided in catalogs or data sheets.

In addition to the maximum area, the leakage area is also required to characterize the valve. The main purpose of the parameter is not to account for possible leakage, even though this is also important, but to maintain numerical integrity of the circuit by preventing a portion of the system

from getting isolated after the valve is completely closed. An isolated or “hanging” part of the system could affect computational efficiency and even cause failure of computation. Therefore, the parameter value must be greater than zero.

Schematic fragments in the next illustration show some typical valve applications: remote control valve (a), pressure-relief valve (b), and pressure-reducing valve (c).

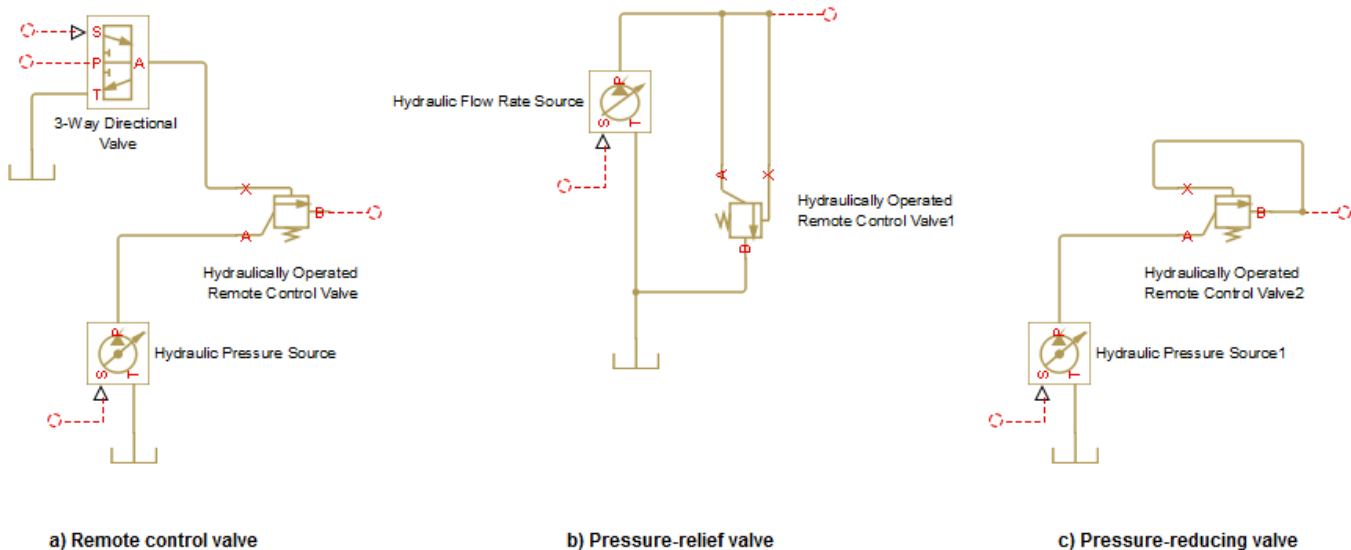

a) Remote control valve

b) Pressure-relief valve

c) Pressure-reducing valve

The flow rate through the orifice is proportional to the orifice opening and the pressure differential across the orifice.

By default, the block does not include valve opening dynamics, and the valve sets its opening area directly as a function of pressure:

$$A = A(p)$$

Adding valve opening dynamics provides continuous behavior that is more physically realistic, and is particularly helpful in situations with rapid valve opening and closing. The pressure-dependent orifice passage area $A(p)$ in the block equations then becomes the steady-state area, and the instantaneous orifice passage area in the flow equation is determined as follows:

$$A(t = 0) = A_{init}$$

$$\frac{dA}{dt} = \frac{A(p) - A}{\tau}$$

In either case, the flow rate through the valve is determined according to the following equations:

$$q = C_D \cdot A \sqrt{\frac{2}{\rho}} \cdot \frac{p}{(p^2 + p_{cr}^2)^{1/4}}$$

For the normally closed valve, the instantaneous orifice passage area $A(p)$ is computed with the equations:

$$A(p) = \begin{cases} A_{leak} & \text{for } p_p \leq p_{crack} \\ A_{leak} + gain \cdot (p_p - p_{crack}) & \text{for } p_{crack} < p_p < p_{max} \\ A_{max} & \text{for } p_p \geq p_{max} \end{cases}$$

For the normally open valve, the equations are similar:

$$A(p) = \begin{cases} A_{max} & \text{for } p_p \leq p_{crack} \\ A_{max} - gain \cdot (p_p - p_{crack}) & \text{for } p_{crack} < p_p < p_{max} \\ A_{leak} & \text{for } p_p \geq p_{max} \end{cases}$$

The rest of the equations apply to both valve configurations:

$$gain = \frac{A_{max} - A_{leak}}{p_{max} - p_{crack}}$$

$$\Delta p = p_A - p_B,$$

where

q	Flow rate through the valve
p	Pressure differential across the valve
p_A, p_B	Gauge pressures at the block terminals
p_p	Gage pressure at the pilot terminal
C_D	Flow discharge coefficient
ρ	Fluid density
τ	Time constant for the first order response of the valve opening
t	Time
A	Instantaneous orifice passage area
$A(p)$	Pressure-dependent orifice passage area
A_{init}	Initial open area of the valve
A_{max}	Fully open valve passage area
A_{leak}	Closed valve leakage area
p_{crack}	Valve cracking pressure
p_{max}	Pilot pressure to shift the control member to its maximum
p_{cr}	Minimum pressure for turbulent flow, when the block transitions from laminar to turbulent regime

The minimum pressure for turbulent flow, p_{cr} , is calculated according to the laminar transition specification method:

- By pressure ratio — The transition from laminar to turbulent regime is defined by the following equations:

$$p_{cr} = (p_{avg} + p_{atm})(1 - B_{lam})$$

$$p_{avg} = (p_A + p_B)/2$$

where

p_{avg}	Average pressure between the block terminals
p_{atm}	Atmospheric pressure, 101325 Pa
B_{lam}	Pressure ratio at the transition between laminar and turbulent regimes (Laminar flow pressure ratio parameter value)

- By Reynolds number — The transition from laminar to turbulent regime is defined by the following equations:

$$p_{cr} = \frac{\rho}{2} \left(\frac{Re_{cr} \cdot \nu}{C_D \cdot D_H} \right)^2$$

$$D_H = \sqrt{\frac{4A}{\pi}}$$

where

D_H	Orifice hydraulic diameter
ν	Fluid kinematic viscosity
Re_{cr}	Critical Reynolds number (Critical Reynolds number parameter value)

Connections A and B are hydraulic conserving ports associated with the inlet and the outlet of the valve. Connection X is the pilot port, which is a hydraulic conserving port that provides the pilot pressure. The block positive direction is from port A to port B. This means that the flow rate is positive if it flows from A to B, and the pressure differential is determined as $\Delta p = p_A - p_B$.

Basic Assumptions and Limitations

- Control member displacement is linearly proportional to pilot pressure.
- No flow consumption is associated with the pilot chamber.
- No loading on the valve, such as inertia, friction, spring, and so on, is considered.

Parameters

Valve type

Select the valve configuration: Normally closed valve or Normally open valve. The default is Normally closed valve.

Maximum passage area

Valve passage maximum cross-sectional area. The default value is $1e-4 \text{ m}^2$.

Cracking pressure

Pressure level at which the valve control member is forced off its seat and starts to either open or close the valve, depending on the valve type. The default value is $3e4 \text{ Pa}$.

Maximum control member displacement pressure

Pilot pressure at which the valve control member shifts to its maximum displacement and remains there until the pressure falls below this level. Its value must be higher than the cracking pressure. The default value is $1.2e5 \text{ Pa}$.

Flow discharge coefficient

Semi-empirical parameter for valve capacity characterization. Its value depends on the geometrical properties of the orifice, and usually is provided in textbooks or manufacturer data sheets. The default value is 0.7.

Laminar transition specification

Select how the block transitions between the laminar and turbulent regimes:

- **Pressure ratio** — The transition from laminar to turbulent regime is smooth and depends on the value of the **Laminar flow pressure ratio** parameter. This method provides better simulation robustness.
- **Reynolds number** — The transition from laminar to turbulent regime is assumed to take place when the Reynolds number reaches the value specified by the **Critical Reynolds number** parameter.

Laminar flow pressure ratio

Pressure ratio at which the flow transitions between laminar and turbulent regimes. The default value is 0.999. This parameter is visible only if the **Laminar transition specification** parameter is set to **Pressure ratio**.

Critical Reynolds number

The maximum Reynolds number for laminar flow. The value of the parameter depends on the orifice geometrical profile. You can find recommendations on the parameter value in hydraulics textbooks. The default value is 12, which corresponds to a round orifice in thin material with sharp edges. This parameter is visible only if the **Laminar transition specification** parameter is set to **Reynolds number**.

Leakage area

The total area of possible leaks in the completely closed valve. The main purpose of the parameter is to maintain numerical integrity of the circuit by preventing a portion of the system from getting isolated after the valve is completely closed. The parameter value must be greater than 0. The default value is $1e-12 \text{ m}^2$.

Opening dynamics

Select one of the following options:

- **Do not include valve opening dynamics** — The valve sets its orifice passage area directly as a function of pressure. If the area changes instantaneously, so does the flow equation. This is the default.
- **Include valve opening dynamics** — Provide continuous behavior that is more physically realistic, by adding a first-order lag during valve opening and closing. Use this option in hydraulic simulations with the local solver for real-time simulation. This option is also helpful if you are interested in valve opening dynamics in variable step simulations.

Opening time constant

The time constant for the first order response of the valve opening. This parameter is available only if **Opening dynamics** is set to **Include valve opening dynamics**. The default value is 0.1 s.

Initial area

The initial opening area of the valve. This parameter is available only if **Opening dynamics** is set to **Include valve opening dynamics**. The default value is $1e-12 \text{ m}^2$.

Restricted Parameters

When your model is in Restricted editing mode, you cannot modify the following parameters:

- **Valve type**
- **Opening dynamics**

All other block parameters are available for modification. The actual set of modifiable block parameters depends on the value of the **Opening dynamics** parameter at the time the model entered Restricted mode.

Global Parameters

Parameters determined by the type of working fluid:

- **Fluid density**
- **Fluid kinematic viscosity**

Use the Hydraulic Fluid block or the Custom Hydraulic Fluid block to specify the fluid properties.

Ports

The block has the following ports:

A

Hydraulic conserving port associated with the valve inlet.

B

Hydraulic conserving port associated with the valve outlet.

X

Hydraulic conserving port that acts as the control port and provides the pilot pressure.

Extended Capabilities

C/C++ Code Generation

Generate C and C++ code using Simulink® Coder™.

See Also

Pressure Reducing Valve | Pressure Relief Valve

Topics

“Upgrading Simscape Fluids Models Containing Hydraulics (Isothermal) Blocks”

Introduced in R2012b

Interface (2P-G)

Two-phase fluid and gas network interface

Library: Simscape / Fluids / Fluid Network Interfaces



Description

The Interface (2P-G) block represents a flow connection between a two-phase fluid network and a gas network. Pressure, temperature, and mass flow rate are equal at the interface. The fluid properties of each fluid network are not transmitted across the interface. To conserve fluid properties, ensure that fluid properties blocks on either side of the interface block have the same network properties.

The fluid on the two-phase fluid side must be superheated. If the fluid vapor fraction at the two-phase fluid port falls below 1 during a simulation, the block will return an error.

Mass and Momentum Balance

Mass is conserved through the block:

$$\dot{m}_{2P} + \dot{m}_G = 0,$$

where:

- \dot{m}_G is the mass flow rate at port **G**.
- \dot{m}_{2P} is the mass flow rate at port **2P**.

The internal and port pressures are equal:

$$P_G = P_I = P_{2P}.$$

Energy Balance

The temperature is maintained between the two fluid ports. The energy balance over the interface is calculated as:

$$\Phi_G + \Phi_{2P} = \dot{m}_G \left(h_{I,G} + \frac{w_{I,G}^2}{2} \right) + \dot{m}_{2P} \left(u_{I,2P} + p_I v_{I,2P} + \frac{w_{I,2P}^2}{2} \right),$$

where:

- Φ_G is the energy flow rate at port **G**.
- Φ_{2P} is the energy flow rate at port **2P**.
- $h_{I,G}$ is the specific enthalpy of the gas at the internal node I.
- p_I is the pressure of the fluids at the internal node I.
- $v_{I,G}$ is the specific volume of the gas at the internal node I.
- $u_{I,2P}$ is the specific energy of the two-phase fluid at the internal node I.

- $v_{I,2P}$ is the specific volume of the two-phase fluid at the internal node I.
- $w_{I,2P}$ is the speed of the fluid on the two-phase fluid side at internal node I:

$$w_{I,2P} = \frac{\dot{m}_{2P} v_{I,2P}}{S},$$

where S is the value of the **Cross-sectional area at ports 2P and G** parameter.

- $w_{I,G}$ is the speed of the fluid on the gas side at internal node I:

$$w_{I,G} = \frac{\dot{m}_G v_{I,G}}{S}.$$

Ports

Conserving

2P – Fluid port

two-phase fluid

Entry or exit port to the two-phase fluid network.

G – Fluid port

gas

Entry or exit port to the gas network.

Parameters

Cross-sectional area at ports 2P and G – Port area

0.01 m² (default) | positive scalar

Cross-sectional area of the thermal liquid and two-phase fluid ports.

See Also

Interface (2P-TL)

Introduced in R2021a

Interface (2P-TL)

Two-phase fluid and thermal liquid network interface

Library: Simscape / Fluids / Fluid Network Interfaces



Description

The Interface (2P-TL) block represents a flow connection between a two-phase fluid network and a thermal liquid network. Pressure, temperature, and mass flow rate are equal at the interface. The fluid properties of each network are not transmitted across the interface. To conserve fluid properties, ensure that the fluid properties blocks on either side of the interface block have the same network properties.

The fluid on the two-phase fluid side must be subcooled. If the fluid vapor fraction at the two-phase fluid port becomes nonzero during a simulation, the block returns an error.

Mass and Momentum Balance

Mass is conserved through the block:

$$\dot{m}_{TL} + \dot{m}_{2P} = 0,$$

where:

- \dot{m}_{TL} is the mass flow rate at port **TL**.
- \dot{m}_{2P} is the mass flow rate at port **2P**.

The internal and port pressures are equal:

$$P_{TL} = P_I = P_{2P}.$$

Energy Balance

The temperature is maintained between the two fluid ports. The energy balance over the interface is calculated as:

$$\Phi_{TL} + \Phi_{2P} = \dot{m}_{TL}(u_{I,TL} + p_I v_{I,TL}) + \dot{m}_{2P} \left(u_{I,2P} + p_I v_{I,2P} + \frac{w_{I,2P}^2}{2} \right),$$

where:

- Φ_{TL} is the energy flow rate at port **TL**.
- Φ_{2P} is the energy flow rate at port **2P**.
- $u_{I,TL}$ is the specific energy of the thermal liquid at the internal node I.
- p_I is the pressure of the fluids at the internal node I.
- $v_{I,TL}$ is the specific volume of the thermal liquid at the internal node I.

- $u_{I,2P}$ is the specific energy of the two-phase fluid at the internal node I.
- $v_{I,2P}$ is the specific volume of the two-phase fluid at the internal node I.
- $w_{I,2P}$ is the speed of the fluid on the two-phase fluid side at the internal node I:

$$w_{I,2P} = \frac{\dot{m}_{2P} v_{I,2P}}{S},$$

where S is the value of the **Cross-sectional area at ports 2P and TL** parameter.

Ports

Conserving

2P – Fluid port

two-phase fluid

Entry or exit port to the two-phase fluid network.

TL – Fluid port

thermal liquid

Entry or exit port to the thermal liquid network.

Parameters

Cross-sectional area at ports 2P and TL – Port area

0.01 m² (default) | positive scalar

Cross-sectional area of the thermal liquid and two-phase fluid ports.

See Also

Interface (2P-G)

Introduced in R2021a

Interface (TL-IL)

Connection between thermal and isothermal networks

Library: Simscape / Fluids / Fluid Network Interfaces



Description

The Interface block is a connector between thermal and isothermal fluid networks. The fluid mass flow rate and pressure are matched between the networks, but fluid properties are not passed between the two networks. To maintain fluid properties between the thermal and isothermal components of your model, connect an Isothermal Liquid Predefined Properties (IL) block with the desired properties to the isothermal network side.

You can connect Thermal Liquid library blocks with Isothermal Liquid library or Hydraulics (Isothermal) library blocks. The temperature set in the isothermal system can either be **Constant** or **Controlled**. In the case of a **Controlled** temperature system, the isothermal network temperature is set by the thermal liquid temperature. In the **Constant** temperature setting, you specify the isothermal network temperature directly.

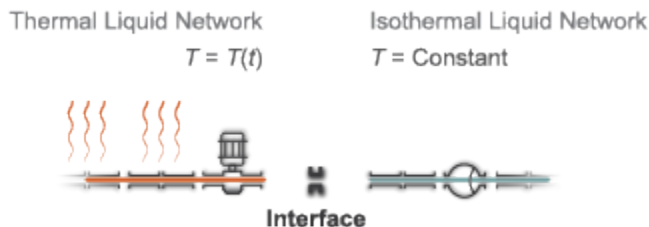

Thermal Liquid - Isothermal Liquid

When **Fluids domain interface** is set to Thermal Liquid (TL) - Isothermal Liquid (IL), the mass flow rate is conserved over the two mass-flow-rate-based networks:

$$\dot{m}_{TL} + \dot{m}_{IL} = 0,$$

where:

- \dot{m}_{TL} is the mass flow rate at the thermal liquid interface.
- \dot{m}_{IL} is the mass flow rate at the isothermal liquid interface.

The fluid absolute pressure is maintained between the thermal, internal, and isothermal sections of the Interface block:

$$p_{TL} = p_{IL}.$$

Thermal Liquid - Hydraulics (Isothermal)

The Hydraulics (Isothermal) Liquid library is based on volumetric flow rate. To maintain flow continuity between both sides of the interface, the volumetric flow rate is multiplied by the fluid density:

$$\dot{m}_{TL} + q_H \rho_H = 0,$$

where:

- q_H is the Hydraulics (Isothermal) volumetric flow rate.
- ρ_H is the local Hydraulics (Isothermal) fluid density.

The Hydraulics (Isothermal) Liquid library blocks are constructed in terms of gauge pressures. Pressure is converted to absolute pressure internally to match the thermal network pressure:

$$p_H + p_{atm} = p_{TL}.$$

Ports

Conserving

TL – Liquid port

thermal liquid

Entry or exit port to the thermal liquid network.

IL – Liquid port

isothermal liquid

Entry or exit port to the isothermal liquid network.

Dependencies

To enable this port, set **Fluids domain interface** to Thermal Liquid (TL) - Isothermal Liquid (IL).

H – Liquid port

isothermal liquid

Entry or exit port to the hydraulics (isothermal) liquid network.

Dependencies

To enable this port, set **Fluids domain interface** to Thermal Liquid (TL) - Hydraulic (H).

Parameters

Fluids domain interface – Connecting library types

Thermal Liquid (TL) - Isothermal Liquid (IL) (default) | Thermal Liquid (TL) - Hydraulic (H)

Specifies the connecting library types.

Temperature specification — Isothermal network temperature

Constant (default) | Controlled

Sets the isothermal network temperature. In the Constant setting, you can specify the isothermal network temperature in the **Hydraulic temperature** parameter. In the Controlled setting, the temperature in the isothermal network is set by the thermal network.

Interface temperature — Isothermal network temperature

293.15 K (default) | positive scalar

Specifies the fluid temperature transmitted from the thermal liquid network to the hydraulic or isothermal liquid network.

Dependencies

To enable this parameter, set **Temperature specification** to Constant.

Cross-sectional area at port TL — Thermal liquid port area0.01 m² (default) | positive scalar

Cross-sectional area of the thermal liquid port.

See Also

Interface (H-IL) | Isothermal Liquid Predefined Properties (IL) | Isothermal Liquid Properties (IL)

Introduced in R2020a

Jet Pump

Jet liquid-liquid pump



Library

Pumps and Motors

Description

The Jet Pump block represents a jet liquid-liquid pump consisting of a nozzle, throat, and diffuser, as shown in the following illustration.

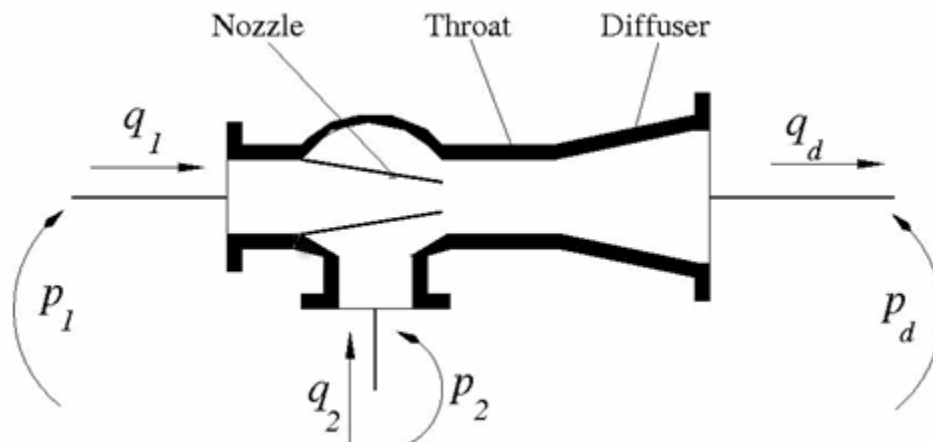

The model is based on the following equations, described in [1 on page 1-1040]:

$$q_1 = \frac{A_n}{\sqrt{1 + K_n}} \sqrt{\frac{2}{\rho} (p_1 - p_0)} \quad (1-8)$$

$$q_2 = \frac{A_n \cdot c}{\sqrt{1 + K_{en}}} \sqrt{\frac{2}{\rho} (p_2 - p_0)} \quad (1-9)$$

$$p_d - p_0 = Zb^2 \left(\frac{2}{b} + \frac{2}{1-b} M^2 - (1 + M)^2 \cdot (1 + K_{th} + K_{di} + a^2) \right) \quad (1-10)$$

$$b = \frac{A_n}{A_{th}}$$

$$c = \frac{1 - b}{b}$$

$$Z = \rho \frac{V_n^2}{2} = \rho \frac{q_1^2}{2A_n^2}$$

$$M = \frac{q_2}{q_1}$$

where

q_1	Primary flow rate pumped through the nozzle
q_2	Secondary flow rate
q_d	Output flow rate
p_1	Pressure at the nozzle inlet
p_2	Pressure at the secondary flow rate inlet
p_0	Pressure at the throat inlet
p_d	Pressure at the pump outlet
A_n	Nozzle area
A_{th}	Throat area
a	Diffuser area ratio, A_{th} / A_d
A_d	Diffuser outlet area
K_n	Nozzle hydraulic loss coefficient
K_{en}	Throat entry hydraulic loss coefficient
K_{th}	Throat hydraulic loss coefficient
K_{di}	Diffuser hydraulic loss coefficient
ρ	Fluid density

“Equation 1-8” describes the nozzle, “Equation 1-9” - throat entry, and “Equation 1-10” - the combination of the throat and the diffuser. The equations correspond to a standard configuration of the pump, where all the longitudinal dimensions conform to established, empirically determined values. For more details, see [1 on page 1-1040].

The pump parameters are closely related to each other, and the methodology described in [1 on page 1-1040] is recommended to determine their initial values.

Basic Assumptions and Limitations

- The model is based on the one-dimensional theory.
- The primary and secondary flows enter the mixing throat with uniform velocity distribution, and the mixed flow leaves the diffuser with uniform velocity distribution.
- The fluid in the primary and secondary flows is the same.
- The fluid is assumed to be incompressible and containing no gas.

Parameters

Nozzle area

Cross-sectional area of the nozzle. The parameter must be greater than zero. The default value is 1 cm^2 .

Throat area

Cross-sectional area of the throat. The throat area is usually two to four times larger than the nozzle area. The default value is 4 cm^2 .

Diffuser inlet/outlet area ratio

The ratio between the inlet and outlet diffuser areas. For a standard pump with a $5^\circ - 7^\circ$ included-angle diffuser, the ratio is close to 0.2. The parameter must be greater or equal to zero. The default value is 0.224.

Nozzle loss coefficient

The hydraulic friction loss coefficient in the nozzle. The parameter must be greater than zero. The default value is 0.05.

Throat entry loss coefficient

The hydraulic friction loss coefficient in the throat entry. The parameter must be greater than zero. The default value is 0.005.

Throat loss coefficient

The hydraulic friction loss coefficient in the throat. The parameter must be greater than zero. The default value is 0.1.

Diffuser loss coefficient

The hydraulic friction loss coefficient in the diffuser. The parameter must be greater than zero. The default value is 0.1.

Global Parameters

Parameters determined by the type of working fluid:

- **Fluid density**

Use the Hydraulic Fluid block or the Custom Hydraulic Fluid block to specify the fluid properties.

Ports

The block has the following ports:

A

Hydraulic conserving port associated with the nozzle entry (primary flow entry).

S

Hydraulic conserving port associated with the pump suction (secondary flow entry).

P

Hydraulic conserving port associated with the pump outlet.

N

Internal nonvisible hydraulic conserving port associated with the throat entry section of the pump. You can view the variables associated with the port by logging simulation data. For more information, see “Data Logging”.

Examples

The “Well with Jet Pump” example represents a well jet pump installation, consisting of a surface-mounted centrifugal pump and a jet pump installed in the well below water level.

References

[1] I.J. Karassic, J.P. Messina, P. Cooper, C.C. Heald, *Pump Handbook*, Fourth edition, McGraw-Hill, NY, 2008

Extended Capabilities**C/C++ Code Generation**

Generate C and C++ code using Simulink® Coder™.

See Also

Centrifugal Pump | Fixed-Displacement Pump | Variable-Displacement Pressure-Compensated Pump | Variable-Displacement Pump

Topics

“Upgrading Simscape Fluids Models Containing Hydraulics (Isothermal) Blocks”

Introduced in R2010b

Jet Pump (IL)

Liquid-liquid jet pump in an isothermal liquid network

Library: Simscape / Fluids / Isothermal Liquid / Pumps & Motors



Description

The Jet Pump (IL) block models a liquid-liquid jet pump in an isothermal liquid network with the same motive and suction fluids. The motive enters the primary nozzle at port **A**, which draws in the suction fluid through input port **S**. After mixing in the throat, the combined flow expands through the diffuser and is discharged at port **B**. The total pressure change over the pump is the sum of the individual contributions of friction and area change in each section of the pump and momentum changes in the throat. The sign convention for the equations below correspond to positive flow into the throat.

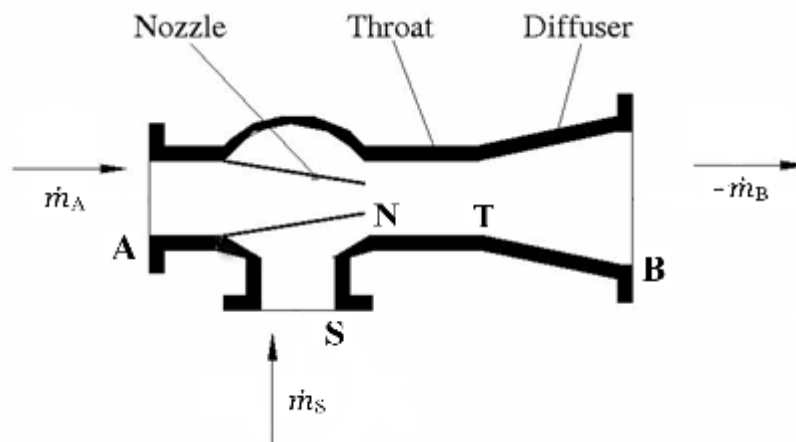

Jet Pump Schematic

Changes in Pressure Due to Area Changes

The mass flow rate is conserved in the pump:

$$\dot{m}_A + \dot{m}_S + \dot{m}_B = 0,$$

where \dot{m}_A is the mass flow rate through port **A**, \dot{m}_S is the mass flow rate through port **S**, and \dot{m}_B is the mass flow rate through port **B**.

Using mass conservation and the Bernoulli Principle, the area changes over the pump segments can be expressed in terms of pressure change. The pressure change associated with the nozzle is:

$$\Delta p_{a, \text{Nozzle}} = \frac{\dot{m}_A^2}{4\rho A_N^2},$$

or 0, whichever is greater. The formulation depends on:

- A_N , the **Nozzle area**, taken at its widest section.
- ρ , the fluid density.

It is assumed that the nozzle inlet is much larger than the nozzle outlet.

Although the geometry of a typical suction inlet is not shaped like a nozzle, it effectively experiences the same type of area reduction as it enters the throat around the nozzle outlet. This annulus is assumed to be much smaller than the suction inlet. The pressure change due to this area reduction is:

$$\Delta p_{a, Annulus} = \frac{\dot{m}_S}{4\rho(A_T - A_N)^2},$$

or 0, whichever is greater. A_T is the cross-sectional area of the throat. The pressure change over the diffuser expansion is:

$$\Delta p_{a, Diffuser} = -\frac{\dot{m}_B^2}{2\rho A_T^2}(1 - a^2),$$

where a is the **Diffuser inlet to outlet area ratio**.

Reversed Flows In the case of reversed flow, the effect of the nozzle area on pressure change is not modeled, and therefore flow traveling from the throat through the nozzle will not undergo any pressure gain. This ensures the numerical stability of the block during simulation of reversed flows.

Changes in Pressure Due to Mixing

Mixing between the motive and suction flows occurs in the throat. This change in momentum is associated with a change in pressure:

$$\Delta p_{mixing} = \frac{\frac{\dot{m}_A^2}{b} + \frac{\dot{m}_S^2}{1-b} - \dot{m}_B^2}{\rho A_T},$$

where b is the **Nozzle to throat area ratio**, which is defined between the largest and smallest cross-sectional areas of the nozzle.

Pressure Losses Due to Friction

The flow experiences losses due to friction in the nozzle, secondary suction inlet, throat, and diffuser. These losses are calculated based on a coefficient defined for each section and the area, or area ratio, between different sections of the pump. Note that friction incurs pressure losses, irrespective of flow direction. The pressure loss in the nozzle due to friction is:

$$\Delta p_{f, Nozzle} = K_N \frac{\dot{m}_A |\dot{m}_A|}{2\rho A_N^2},$$

where K_N is the **Primary flow nozzle loss coefficient**. The pressure loss due to friction in the suction flow through the annulus is:

$$\Delta p_{f, Annulus} = K_S \frac{\dot{m}_S |\dot{m}_S|}{2\rho(A_T - A_N)^2},$$

where K_S is the **Secondary flow entry loss coefficient**. The pressure loss in the throat due to friction is:

$$\Delta p_{f, Throat} = K_T \frac{\dot{m}_B |\dot{m}_B|}{2\rho A_T^2},$$

where K_T is the **Throat loss coefficient**. The pressure loss in the diffuser due to friction is:

$$\Delta p_{f, Diffuser} = K_D \frac{\dot{m}_B |\dot{m}_B|}{2\rho A_T^2},$$

where K_D is the **Diffuser loss coefficient**. Note that the sign corresponds to negative flow from the throat toward port **B**. Losses are defined for the regions of highest velocity in the flow. For this reason, the throat area, which is equal to the diffuser inlet area, is used in the diffuser loss equation.

Saturation Pressure in the Nozzle

Cavitation occurs when a region of low pressure in the flow falls below the vapor saturation pressure. This creates pockets of vapor in the liquid and impedes any further increase in flow through the pump. You can model this flow rate limit by specifying a **Minimum nozzle pressure**, beyond which the fluid velocity will remain constant. The total pressure change over the pump depends on this pressure threshold at the nozzle outlet. Between the nozzle and the diffuser, the pressure change is either

$$p_B - p_N = \Delta p_{mixing} + \Delta p_{f, Throat} + \Delta p_{f, Diffuser} - \Delta p_{a, Diffuser}$$

or $p_B - p_{N, \min}$, whichever is smaller.

The total pressure change in the nozzle is:

$$p_A - p_N = \Delta p_{a, Nozzle} + \Delta p_{f, Nozzle}.$$

The total pressure change in the annulus is:

$$p_S - p_N = \Delta p_{a, Annulus} + \Delta p_{f, Annulus}.$$

Assumptions and Limitations

- The motive and suction liquids are the same.
- Mixing in the throat is assumed to be uniform and complete.
- The nozzle inlet is much larger than the nozzle outlet, and the suction jet annulus is much smaller than the suction inlet.
- The change in pressure due to the nozzle is not modeled for reversed flows.
- Any effect of cavitation is modeled as a maximum limit on the flow rate in the throat.

Ports

Conserving

A – Liquid port

isothermal liquid

Motive liquid inlet port.

S – Liquid port

isothermal liquid

Suction liquid inlet port.

B – Liquid port

isothermal liquid

Mixed fluid outlet port.

Parameters

Nozzle area – Nozzle inlet area

$1e-4 \text{ m}^2$ (default) | positive scalar

Cross-sectional area of the inlet nozzle at its widest section. The motive liquid enters the jet pump through the nozzle.

Nozzle to throat area ratio – Nozzle outlet to throat area

0.25 (default) | positive scalar

Characteristic ratio of the nozzle outlet and throat cross-sectional areas.

Diffuser inlet to outlet area ratio – Diffuser geometry ratio

0.25 (default) | positive scalar

Characteristic ratio of the diffuser inlet and outlet cross-sectional areas.

Primary flow nozzle loss coefficient – Friction loss coefficient

0.05 (default) | positive scalar

Characterizes the losses in pressure due to nozzle friction in the motive flow.

Secondary flow entry loss coefficient – Friction loss coefficient

0.005 (default) | positive scalar

Characterizes the losses in pressure in the suction flow due to the suction inlet friction.

Throat loss coefficient – Friction loss coefficient

0.1 (default) | positive scalar

Characterizes the losses in pressure in the mixture due to throat friction.

Diffuser loss coefficient – Friction loss coefficient

0.1 (default) | positive scalar

Characterizes the losses in pressure due in the mixed flow due to friction in the diffuser.

Minimum nozzle pressure – Minimum pressure at the nozzle outlet

0.1 Pa (default) | positive scalar

Sets the maximum allowed pressure change in the jet pump. If pressures at the nozzle exit fall below this value, the block simulates the effect of cavitation by restricting the fluid velocity to the velocity at the minimum nozzle pressure.

See Also

Fixed-Displacement Pump (IL) | Variable-Displacement Pump (IL) | Pressure-Compensated Pump (IL) | Centrifugal Pump (IL)

Introduced in R2020a

Journal Bearing Pressure-Fed

Hydraulic portion of pressure-fed journal bearing



Library

Orifices

Description

The Journal Bearing Pressure-Fed block simulates the hydraulic portion of a pressure-fed journal bearing, shown in the following illustration.

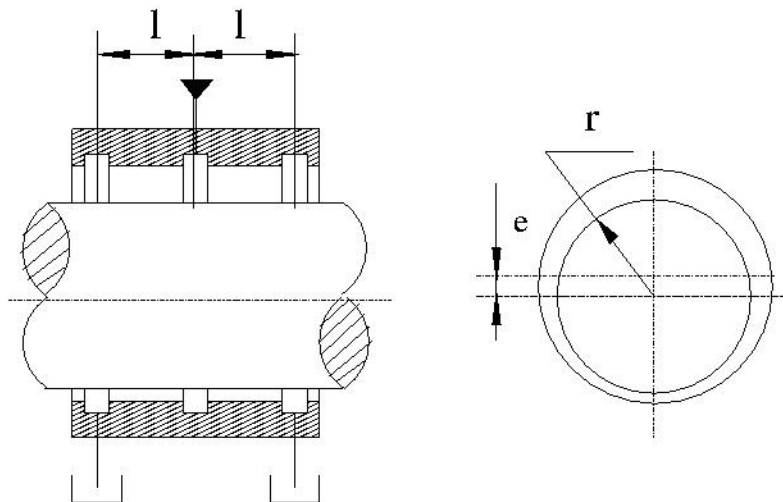

The lubricant under pressure p is pumped into the circumferential groove at the center of the bearing. The groove divides the bearing into two half-bearings. The lubricant exits through the end grooves located at a distance l from the central groove. The model is intended to be used in lubrication system simulation to assess the flow consumption through the pressure-fed journal bearing. The flow regime is assumed to be laminar due to very small clearances between the journal and the bushing.

The flow rate is computed using the Hagen-Poiseuille equation (see [1] on page 1-1048):

$$q = \frac{\pi p r c^3}{3\mu l} (1 + 1.5\varepsilon^2)$$

where

q	Volumetric flow rate
p	Pressure differential across the bearing
r	Journal radius
c	Radial clearance at neutral position
μ	Dynamic viscosity
l	Length of the half-bearing
ε	Relative eccentricity, $\varepsilon = e / r$
e	Eccentricity or journal deflection from the central position

The journal radial displacement, which controls the bearing eccentricity, is imported through the physical signal port J. Connections A and B are hydraulic conserving ports associated with the bearing inlet and outlet, respectively. The block positive direction is from port A to port B. This means that the flow rate is positive if it flows from A to B and the pressure differential is determined as $\Delta p = p_A - p_B$. Positive signal at the physical signal port J increases the eccentricity and is limited to the radial clearance of the bearing.

Basic Assumptions and Limitations

The flow regime is assumed to be laminar due to small clearances.

Parameters

Journal radius

The radius of the journal. The parameter must be positive. The default value is 0.05 m.

Radial clearance

The radial clearance between the journal and the bushing at neutral position. The parameter must be positive. The default value is 2e-4 m.

Bearing half-length

The length of the half-bearing, that is, the distance between each of the end grooves and the central groove. The parameter must be positive. The default value is 0.025 m.

Global Parameters

Parameters determined by the type of working fluid:

- **Fluid density**
- **Fluid kinematic viscosity**

Use the Hydraulic Fluid block or the Custom Hydraulic Fluid block to specify the fluid properties.

Ports

The block has the following ports:

A

Hydraulic conserving port associated with the bearing inlet.

B

Hydraulic conserving port associated with the bearing outlet.

J

Physical signal port that controls the journal deflection.

References

[1] Shigley, J., C. Mischke, and R. Budynas. *Mechanical Engineering Design*. New York: McGraw-Hill, 2004.

Extended Capabilities

C/C++ Code Generation

Generate C and C++ code using Simulink® Coder™.

See Also

Topics

“Upgrading Simscape Fluids Models Containing Hydraulics (Isothermal) Blocks”

Introduced in R2012b

Local Resistance

Hydraulic resistance specified by loss coefficient



Library

Local Hydraulic Resistances

Description

The Local Resistance block represents a generic local hydraulic resistance, such as a bend, elbow, fitting, filter, local change in the flow cross section, and so on. The pressure loss caused by resistance is computed based on the pressure loss coefficient, which is usually provided in catalogs, data sheets, or hydraulic textbooks. The pressure loss coefficient can be specified either as a constant, or by a table, in which it is tabulated versus Reynolds number.

The pressure drop between port **A** and port **B** is:

$$\Delta p = p_A - p_B,$$

where:

- p is the pressure drop.
- p_A is the gauge pressure at port **A**.
- p_B is the gauge pressure at port **B**.

If the **Model parameterization** parameter is set to `By semi-empirical formulas`, the pressure drop is related to the volumetric flow rate by the expression:

$$q = A \sqrt{\frac{2}{K \cdot \rho}} \cdot \frac{p}{(p^2 + p_{Cr}^2)^{1/4}}$$

where:

- q is the volumetric flow rate.
- A is the flow area.
- K is the pressure loss coefficient of the flow resistance.
- ρ is the fluid density.
- p_{Cr} is the minimum pressure for turbulent flow.

If the **Model parameterization** parameter is set to `By loss coefficient vs. Re table`, the pressure drop is related to the volumetric flow rate by the expression:

$$p = K(\text{Re}) \rho \frac{q|q|}{2A^2}$$

where K is now a function of the Reynolds number (Re). Its value is specified in the block dialog box in tabulated form against the Reynolds number:

$$Re = \frac{q \cdot D_H}{A \cdot \nu}$$

where:

- D_H is the hydraulic diameter of the flow resistance:

$$D_H = \sqrt{\frac{4A}{\pi}}$$

- ν is the kinematic viscosity.

For a constant pressure loss coefficient, the minimum pressure for turbulent flow, p_{cr} , is calculated according to the laminar transition specification method:

- By pressure ratio — The transition from laminar to turbulent regime is defined by the following equations:

$$p_{cr} = (p_{avg} + p_{atm})(1 - B_{lam})$$

$$p_{avg} = (p_A + p_B)/2$$

where

p_{avg}	Average pressure between the block terminals
p_{atm}	Atmospheric pressure, 101325 Pa
B_{lam}	Pressure ratio at the transition between laminar and turbulent regimes (Laminar flow pressure ratio parameter value)

- By Reynolds number — The transition from laminar to turbulent regime is defined by the following equations:

$$p_{cr} = K \frac{\rho}{2} \left(\frac{Re_{cr} \cdot \nu}{D_H} \right)^2$$

where

Re_{cr}	Critical Reynolds number (Critical Reynolds number parameter value)
-----------	---

The block provides two parameterizations:

- By **semi-empirical formulas** — The pressure loss coefficient is assumed to be constant for a specific flow direction. The flow regime can be either laminar or turbulent, depending on the Reynolds number.
- By **loss coefficient vs. Re table** — The pressure loss coefficient is specified as a function of the Reynolds number. The flow regime is assumed to be turbulent at all times. You must ensure that the loss coefficient data corresponds to this flow regime.

The resistance can be symmetrical or asymmetrical. In symmetrical resistances, the pressure loss practically does not depend on flow direction and one value of the coefficient is used for both the direct and reverse flow. For asymmetrical resistances, the separate coefficients are provided for each

flow direction. If the loss coefficient is specified by a table, the table must cover both the positive and the negative flow regions.

Connections A and B are conserving hydraulic ports associated with the block inlet and outlet, respectively.

The block positive direction is from port A to port B. This means that the flow rate is positive if fluid flows from A to B, and the pressure loss is determined as $\Delta p = p_A - p_B$.

Basic Assumptions and Limitations

- Fluid inertia is not taken into account.
- If you select parameterization by the table-specified relationship $K=f(Re)$, the flow is assumed to be completely turbulent.

Parameters

- “Parameters Tab” on page 1-1051
- “Variables Tab” on page 1-1053

Parameters Tab

Resistance area

The smallest passage area. The default value is $1e-4 \text{ m}^2$.

Model parameterization

Select one of the following methods for specifying the pressure loss coefficient:

- **By semi-empirical formulas** — Provide a scalar value for the pressure loss coefficient. For asymmetrical resistances, you have to provide separate coefficients for direct and reverse flow. This is the default method.
- **By loss coefficient vs. Re table** — Provide tabulated data of loss coefficients and corresponding Reynolds numbers. The loss coefficient is determined by one-dimensional table lookup. You have a choice of two interpolation methods and two extrapolation methods. For asymmetrical resistances, the table must cover both the positive and the negative flow regions.

Pressure loss coefficient for direct flow

Loss coefficient for the direct flow (flowing from A to B). For simple ideal configurations, the value of the coefficient can be determined analytically, but in most cases its value is determined empirically and provided in textbooks and data sheets (for example, see [1] on page 1-1054). The default value is 2. This parameter is used if **Model parameterization** is set to **By semi-empirical formulas**.

Pressure loss coefficient for reverse flow

Loss coefficient for the reverse flow (flowing from B to A). The parameter is similar to the loss coefficient for the direct flow and must be set to the same value if the resistance is symmetrical. The default value is 2. This parameter is used if **Model parameterization** is set to **By semi-empirical formulas**.

Laminar transition specification

If **Model parameterization** is set to `By semi-empirical formulas`, select how the block transitions between the laminar and turbulent regimes:

- **Pressure ratio** — The transition from laminar to turbulent regime is smooth and depends on the value of the **Laminar flow pressure ratio** parameter. This method provides better simulation robustness.
- **Reynolds number** — The transition from laminar to turbulent regime is assumed to take place when the Reynolds number reaches the value specified by the **Critical Reynolds number** parameter.

Laminar flow pressure ratio

Pressure ratio at which the flow transitions between laminar and turbulent regimes. The default value is `0.999`. This parameter is visible only if the **Laminar transition specification** parameter is set to `Pressure ratio`.

Critical Reynolds number

The maximum Reynolds number for laminar flow. The value of the parameter depends on the orifice geometrical profile. You can find recommendations on the parameter value in hydraulics textbooks. The default value is `150`. This parameter is visible only if the **Laminar transition specification** parameter is set to `Reynolds number`.

Reynolds number vector

Specify the vector of input values for Reynolds numbers as a one-dimensional array. The input values vector must be strictly increasing. The values can be nonuniformly spaced. The minimum number of values depends on the interpolation method: you must provide at least two values for linear interpolation, at least three values for smooth interpolation. The default values are `[-4000, -3000, -2000, -1000, -500, -200, -100, -50, -40, -30, -20, -15, -10, 10, 20, 30, 40, 50, 100, 200, 500, 1000, 2000, 4000, 5000, 10000]`. This parameter is used if **Model parameterization** is set to `By loss coefficient vs. Re table`.

Loss coefficient vector

Specify the vector of the loss coefficient values as a one-dimensional array. The loss coefficient vector must be of the same size as the Reynolds numbers vector. The default values are `[0.25, 0.3, 0.65, 0.9, 0.65, 0.75, 0.90, 1.15, 1.35, 1.65, 2.3, 2.8, 3.10, 5, 2.7, 1.8, 1.46, 1.3, 0.9, 0.65, 0.42, 0.3, 0.20, 0.40, 0.42, 0.25]`. This parameter is used if **Model parameterization** is set to `By loss coefficient vs. Re table`.

Interpolation method

Select one of the following interpolation methods for approximating the output value when the input value is between two consecutive grid points:

- **Linear** — Select this option to get the best performance.
- **Smooth** — Select this option to produce a continuous curve with continuous first-order derivatives.

For more information on interpolation algorithms, see the PS Lookup Table (1D) block reference page. This parameter is used if **Model parameterization** is set to `By loss coefficient vs. Re table`.

Extrapolation method

Select one of the following extrapolation methods for determining the output value when the input value is outside the range specified in the argument list:

- **Linear** — Select this option to produce a curve with continuous first-order derivatives in the extrapolation region and at the boundary with the interpolation region.
- **Nearest** — Select this option to produce an extrapolation that does not go above the highest point in the data or below the lowest point in the data.

For more information on extrapolation algorithms, see the PS Lookup Table (1D) block reference page. This parameter is used if **Model parameterization** is set to `By loss coefficient vs. Re table`.

Variables Tab

Flow rate

Volumetric flow rate through the local resistance at time zero. Simscape software uses this parameter to guide the initial configuration of the component and model. Initial variables that conflict with each other or are incompatible with the model may be ignored. Set the **Priority** column to `High` to prioritize this variable over other, low-priority, variables.

Pressure differential

Pressure differential between the local resistance ports at time zero. Simscape software uses this parameter to guide the initial configuration of the component and model. Initial variables that conflict with each other or are incompatible with the model may be ignored. Set the **Priority** column to `High` to prioritize this variable over other, low-priority, variables.

Restricted Parameters

When your model is in Restricted editing mode, you cannot modify the following parameters:

- **Model parameterization**
- **Interpolation method**
- **Extrapolation method**
- **Laminar transition specification**

All other block parameters are available for modification. The actual set of modifiable block parameters depends on the value of the **Model parameterization** parameter at the time the model entered Restricted mode.

Global Parameters

Parameters determined by the type of working fluid:

- **Fluid density**
- **Fluid kinematic viscosity**

Use the Hydraulic Fluid block or the Custom Hydraulic Fluid block to specify the fluid properties.

Ports

The block has the following ports:

A

Hydraulic conserving port associated with the resistance inlet.

B

Hydraulic conserving port associated with the resistance outlet.

References

[1] Idelchik, I.E., *Handbook of Hydraulic Resistance*, CRC Begell House, 1994

Extended Capabilities

C/C++ Code Generation

Generate C and C++ code using Simulink® Coder™.

See Also

Elbow | Gradual Area Change | Pipe Bend | Sudden Area Change | T-junction

Topics

“Upgrading Simscape Fluids Models Containing Hydraulics (Isothermal) Blocks”

Introduced in R2006a

Local Resistance (IL)

Pipe resistances in an isothermal liquid system

Library: Simscape / Fluids / Isothermal Liquid / Pipes & Fittings



Description

The Local Resistance (IL) block models pressure loss due to user-defined pipe resistances in an isothermal liquid system. You can specify different loss coefficients for forward and reversed flows through the pipe segment. For pipe bends, you can also choose to use the Isothermal Liquid library blocks Pipe Bend (IL) and Elbow (IL) or, for area changes, the Area Change (IL) block.

The loss factor is parameterized by either a constant relationship based on the pipe pressure or by user-supplied tabular data for loss coefficients based on the Reynolds number.

Constant Loss Factor

Segments with loss factors that remain constant over a range of flow velocities are calculated as:

$$k_{loss} = k_{loss,BA} + \frac{(k_{loss,AB} - k_{loss,BA})}{2} \left[\tanh\left(\frac{3\Delta p}{\Delta p_{crit}}\right) + 1 \right],$$

where:

- $k_{loss,AB}$ and $k_{loss,BA}$ are the **Forward flow loss coefficient (from A to B)** and **Reverse flow loss coefficient (from B to A)** parameters, respectively.
- Δp is the pressure difference $p_A - p_B$.

The critical pressure difference, Δp_{crit} is the pressure differential associated with the **Critical Reynolds number**, Re_{crit} , which is the flow regime transition point between laminar and turbulent flow:

$$\Delta p_{crit} = \frac{\bar{\rho}}{2} k_{loss,crit} \left(\frac{\nu Re_{crit}}{D_h} \right)^2,$$

where:

- $k_{loss,crit}$ is the loss factor associated with the critical pressure, and is based on an average of the forward and reverse loss coefficients.
- ν is the fluid kinematic viscosity.
- $\bar{\rho}$ is the average fluid density.
- D_h is the segment hydraulic diameter, which is the equivalent diameter of a pipe with a non-circular cross-section: $D_h = \sqrt{\frac{4}{\pi A_{flow}}}$, where A_{flow} is the **Flow area**.

Tabulated Loss Coefficient

The loss coefficient can alternatively be interpolated from user-provided Reynolds number and loss coefficient data. The vector of Reynolds numbers can have both positive and negative values, indicating forward and reverse flow, respectively: $k_{loss} = TLU(Re)$.

Mass Flow Rate

Mass is conserved through the valve:

$$\dot{m}_A + \dot{m}_B = 0.$$

The mass flow rate through the valve is calculated as:

$$\dot{m} = A_{flow} \frac{\sqrt{2\rho}}{\sqrt{k_{loss}}} \frac{\Delta p}{[\Delta p^2 + \Delta p_{crit}^2]^{1/4}},$$

where k_{loss} is the flow loss coefficient, which is selected between the **Forward flow loss coefficient (from A to B)** and **Reverse flow loss coefficient (from B to A)** based on the block flow direction.

Ports

Conserving

A – Liquid port

isothermal liquid

Liquid entry or exit port to the pipe segment. Flow is positive from port **A** to port **B**.

B – Liquid port

isothermal liquid

Liquid entry or exit port to the pipe segment. Flow is positive from port **A** to port **B**.

Parameters

Local loss parameterization – Loss factor calculation method

Constant (default) | Tabulated data - loss coefficient vs. Reynolds number

Method of calculating the pipe segment loss factor. The loss factor is parameterized by either a linear relationship between the segment pressure drop and constant loss factor or by interpolation of user-provided loss factor and Reynolds number data.

Forward flow loss coefficient (from A to B) – Loss coefficient for flow from A to B

1 (default) | positive scalar

Loss coefficient associated with pressure loss for flows from port **A** to port **B**.

Reverse flow loss coefficient (from B to A) – Loss coefficient for flow from B to A

1 (default) | positive scalar

Loss coefficient associated with pressure loss for flows from port **B** to port **A**.

Reynolds number vector – Vector of Reynolds numbers for tabular parameterization

[-500, -200, -100, -50, -40, -30, -20, -10, 10, 20, 30, 40, 50, 100, 200, 500, 1000, 2000] (default) | 1-by- n vector

Vector of Reynolds numbers for the tabular parameterization of the loss coefficient. The vector elements must correspond one-to-one with the elements in the **Loss coefficient vector** parameter. The elements are listed in ascending order.

Dependencies

To enable this parameter, set **Local loss parameterization** to Tabulated data - loss coefficient vs. Reynolds number.

Loss coefficient vector – Vector of loss coefficients for tabular parameterization

[.65, .75, .9, 1.15, 1.35, 1.65, 2.3, 3.1, 4, 2.7, 1.8, 1.46, 1.3, .9, .65, .42, .3, .2] (default) | 1-by- n vector

Vector of loss coefficients for the tabular parameterization of the loss coefficient. The vector elements must correspond one-to-one with the elements in the **Reynolds number vector** parameter. The elements must be greater than 0.

Dependencies

To enable this parameter, set **Local loss parameterization** to Tabulated data - loss coefficient vs. Reynolds number.

Flow area – Segment cross-sectional area

$1e-3 \text{ m}^2$ (default) | positive scalar

Cross-sectional area of the pipe segment.

Critical Reynolds number – Upper Reynolds number limit for laminar flow

150 (default) | positive scalar

Upper Reynolds number limit for laminar flow through the valve.

See Also

Area Change (IL) | Pipe Bend (IL) | Elbow (IL) | T-Junction (IL)

Introduced in R2020a

Multiposition Valve Actuator

Multiposition actuator in an isothermal liquid system

Library: Simscape / Fluids / Valve Actuators
 Simscape / Fluids / Isothermal Liquid / Valves & Orifices /
 Valve Actuators & Forces / Valve Actuators



Description

The Multiposition Valve Actuator block models a multiposition actuator in an isothermal liquid system. It can be used in combination with the 2-Way Directional Valve (IL), 3-Way Directional Valve (IL), or 4-Way 3-Position Directional Valve (IL) blocks. The actuator position is influenced by the input signal and switching time, and not by loading.

Two-Position Actuator Movement

Actuation begins when the signal at port **A** exceeds 50% of the **Nominal signal value**. After the time period set by the **Switching-on time** parameter, the actuator begins to move toward the **Push-pin stroke limit**. When the input signal at port **A** falls below 50% of the **Nominal signal value**, the actuator reverses its direction after the time period set by the **Switching-off time** parameter. The motion can be interrupted mid-stroke.

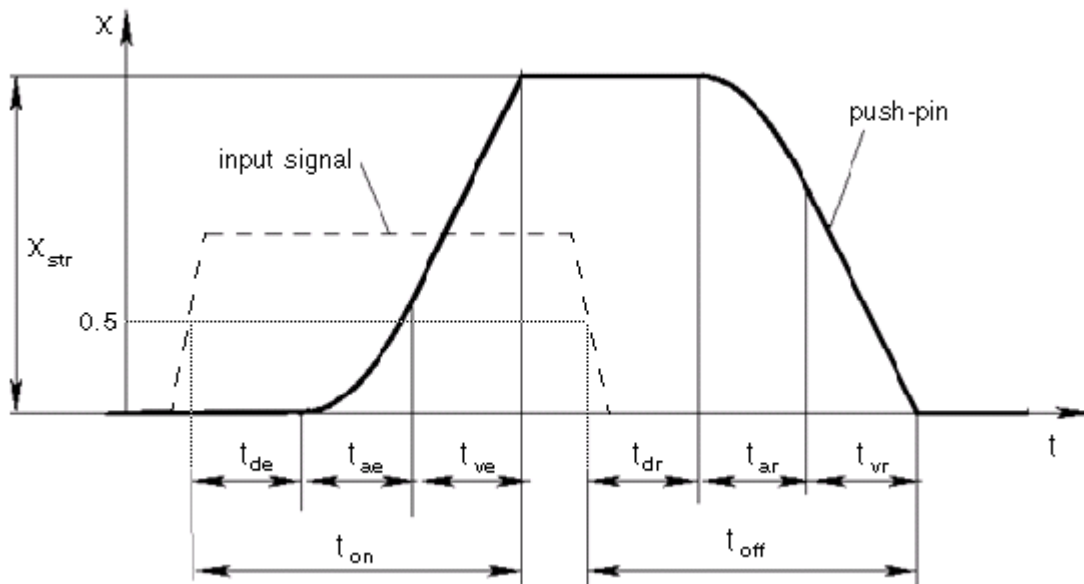

Actuator position

In the image above, t_{de} is the **Switching-on time**, which is equal to the time periods t_{ae} and t_{ve} . In region t_{ae} , the actuator moves at constant acceleration with parabolic displacement. In region t_{ve} , the actuator moves linearly, with constant velocity, toward full push-pin extension. The actuator switches direction when the control signal is off:

- 1 t_{dr} is a transitional no-displacement time period set by the **Switching-off time**.
- 2 t_{ar} is a period of acceleration with parabolic displacement.
- 3 t_{vr} is period of linear displacement toward the actuator **Initial position**.

When **Actuator positions** is set to 2, the **Actuator travel direction** parameter sets the direction of the push-pin motion.

The actuator motion can be interrupted at any time. If the push-pin motion is disrupted mid-stroke, the switch-on and switch-off times are adjusted proportionally to the push-pin position, relative to the push-pin stroke.

Three-Position Actuator Movement

When **Actuator positions** is set to 3, the signal at port **A** moves the actuator in a positive direction and the signal received at port **B** moves the actuator in a negative direction. Only one signal, from one port, is processed at a time. To switch control between ports **A** and **B**, or between positive and negative displacement control, the actuator must first move to a neutral position. If the push-pin motion is disrupted mid-stroke, the switch-on and switch-off times are adjusted proportionally to the push-pin position, relative to the push-pin stroke. The actuator motion can be interrupted at any time.

When controlled by the signal at port **A**, the three-position actuator has the same displacement profile as the two-position actuator when **Actuator travel direction** is set to **Positive**. When controlled by the signal at port **B**, it has the same profile as the two-position actuator when **Actuator travel direction** is set to **Negative**.

Ports

Input

A — Input signal

physical signal

Input port, specified as a physical signal.

When **Actuator positions** is set to 2, this port can either control negative or positive actuator movement, according to the **Actuator orientation** setting.

When **Actuator positions** is set to 3, this port receives a physical signal that corresponds to a positive actuator displacement direction.

B — Input signal

physical signal

Input port for negative actuator displacement, received as a physical signal.

Dependencies

To enable this port, set **Actuator positions** to 3.

Output

S — Actuator position, in m

physical signal

Actuator position in m, specified as a physical signal.

Parameters

Actuator positions — Number of valve position signals

2 (default) | 3

Number of valve position signals. When set to 2, the actuator receives one signal and sets one position signal. When set to 3, the actuator receives a positive and a negative signal and sets one position signal.

Push-pin stroke — Maximum push-pin extension

0.01 m (default) | positive scalar

Maximum push-pin extension.

Switching-on time — Signal transition time period

0.1 s (default) | positive scalar

Transitional time period before the actuator begins to move. The period begins after the input signal rises above 50% of the **Nominal signal value**.

Switching-off time — Signal transition time period

0.1 s (default) | positive scalar

Transitional time period before the actuator reverses motion. The period begins after the input signal falls below 50% of the **Nominal signal value**.

Nominal signal value — Nominal signal for fully extended actuator

24 (default) | positive scalar

Nominal signal for fully extended actuator. The actuator motion is triggered when the input signal reaches 50% of the **Nominal signal value**.

Initial position — Actuator starting position

Retracted (default) | Extended | Neutral

Starting position of the actuator. Retracted and Extended correspond to the actuator push-pin stroke limits.

When **Actuator positions** is set to 2, the **Initial position** default is Retracted. When **Actuator positions** is set to 3, the **Initial position** default is Neutral. Neutral corresponds to the middle of the **Push-pin stroke**.

Actuator orientation — Direction of actuator motion

Positive (default) | Negative

Direction of the actuator motion in response to the physical signal input. The Positive setting corresponds to push-pin extension.

Dependencies

To enable this parameter, set **Actuator positions** to 2.

Extended Capabilities

C/C++ Code Generation

Generate C and C++ code using Simulink® Coder™.

See Also

Proportional Valve Actuator | Pilot Valve Actuator (IL) | Cartridge Valve Actuator (IL) | 2-Way Directional Valve (IL) | 3-Way Directional Valve (IL) | 4-Way 3-Position Directional Valve (IL)

Introduced in R2020a

Needle Valve

Hydraulic needle valve



Library

Flow Control Valves

Description

The Needle Valve block models a variable orifice created by a conical needle and a round sharp-edged orifice in thin material.

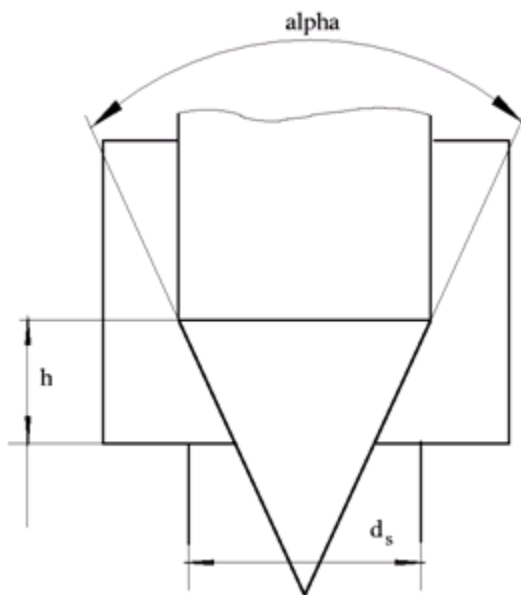

The flow rate through the valve is proportional to the valve opening and to the pressure differential across the valve. The flow rate is determined according to the following equations:

$$q = C_D \cdot A(h) \sqrt{\frac{2}{\rho} \frac{\Delta p}{(\Delta p^2 + p_{Cr}^2)^{1/4}}}$$

$$\Delta p = p_A - p_B,$$

$$h = x_0 + x$$

$$h_{\max} = d_s \frac{1 - \sqrt{1 - \cos \frac{\alpha}{2}}}{\sin \alpha}$$

$$A(h) = \begin{cases} A_{\text{leak}} & \text{for } h < = 0 \\ \pi \cdot \left(d_s - h \cdot \sin \frac{\alpha}{2} \cdot \cos \frac{\alpha}{2} \right) \cdot h \cdot \sin \frac{\alpha}{2} + A_{\text{leak}} & \text{for } 0 < h < h_{\max} \\ A_{\max} + A_{\text{leak}} & \text{for } h > = h_{\max} \end{cases}$$

$$A_{\max} = \frac{\pi d_s^2}{4}$$

where

q	Flow rate
p	Pressure differential
p_A, p_B	Gauge pressures at the block terminals
C_D	Flow discharge coefficient
$A(h)$	Instantaneous orifice passage area
x_0	Initial opening
x	Needle displacement from initial position
h	Valve opening
h_{\max}	Maximum needle stroke
d_s	Orifice diameter
α	Needle angle
ρ	Fluid density
A_{leak}	Closed valve leakage area
A_{\max}	Maximum valve open area
p_{cr}	Minimum pressure for turbulent flow

The minimum pressure for turbulent flow, p_{cr} , is calculated according to the laminar transition specification method:

- By pressure ratio — The transition from laminar to turbulent regime is defined by the following equations:

$$p_{\text{cr}} = (p_{\text{avg}} + p_{\text{atm}})(1 - B_{\text{lam}})$$

$$p_{\text{avg}} = (p_A + p_B)/2$$

where

p_{avg}	Average pressure between the block terminals
p_{atm}	Atmospheric pressure, 101325 Pa
B_{lam}	Pressure ratio at the transition between laminar and turbulent regimes (Laminar flow pressure ratio parameter value)

- By Reynolds number — The transition from laminar to turbulent regime is defined by the following equations:

$$p_{cr} = \frac{\rho}{2} \left(\frac{Re_{cr} \cdot \nu}{C_D \cdot D_H} \right)^2$$

$$D_H = \sqrt{\frac{4A}{\pi}}$$

where

D_H	Valve instantaneous hydraulic diameter
ν	Fluid kinematic viscosity
Re_{cr}	Critical Reynolds number (Critical Reynolds number parameter value)

The block positive direction is from port A to port B. This means that the flow rate is positive if it flows from A to B and the pressure differential is determined as $\Delta p = p_A - p_B$. Positive signal at the physical signal port S opens the valve.

Basic Assumptions and Limitations

- Fluid inertia is not taken into account.
- The flow passage area is assumed to be equal to the frustum side surface area.

Parameters

Valve orifice diameter

The diameter of the orifice of the valve. The default value is 0.005 m.

Needle cone angle

The angle of the valve conical needle. The parameter value must be in the range between 0 and 180 degrees. The default value is 90 degrees.

Initial opening

The initial opening of the valve. You can specify both positive and negative values. The default value is 0.

Flow discharge coefficient

Semi-empirical parameter for valve capacity characterization. Its value depends on the geometrical properties of the orifice, and usually is provided in textbooks or manufacturer data sheets. The default value is 0.65.

Laminar transition specification

Select how the block transitions between the laminar and turbulent regimes:

- **Pressure ratio** — The transition from laminar to turbulent regime is smooth and depends on the value of the **Laminar flow pressure ratio** parameter. This method provides better simulation robustness.
- **Reynolds number** — The transition from laminar to turbulent regime is assumed to take place when the Reynolds number reaches the value specified by the **Critical Reynolds number** parameter.

Laminar flow pressure ratio

Pressure ratio at which the flow transitions between laminar and turbulent regimes. The default value is 0.999. This parameter is visible only if the **Laminar transition specification** parameter is set to Pressure ratio.

Critical Reynolds number

The maximum Reynolds number for laminar flow. The value of the parameter depends on the orifice geometrical profile. You can find recommendations on the parameter value in hydraulics textbooks. The default value is 10. This parameter is visible only if the **Laminar transition specification** parameter is set to Reynolds number.

Leakage area

The total area of possible leaks in the completely closed valve. The main purpose of the parameter is to maintain numerical integrity of the circuit by preventing a portion of the system from getting isolated after the valve is completely closed. The parameter value must be greater than 0. The default value is $1e-12 \text{ m}^2$.

Global Parameters

Parameters determined by the type of working fluid:

- **Fluid density**
- **Fluid kinematic viscosity**

Use the Hydraulic Fluid block or the Custom Hydraulic Fluid block to specify the fluid properties.

Ports

The block has the following ports:

A

Hydraulic conserving port associated with the valve inlet.

B

Hydraulic conserving port associated with the valve outlet.

S

Physical signal port to control spool displacement.

Extended Capabilities

C/C++ Code Generation

Generate C and C++ code using Simulink® Coder™.

See Also

Ball Valve | Gate Valve | Poppet Valve | Pressure-Compensated Flow Control Valve

Topics

“Upgrading Simscape Fluids Models Containing Hydraulics (Isothermal) Blocks”

Introduced in R2006a

Needle Valve (IL)

Needle valve in an isothermal liquid system

Library: Simscape / Fluids / Isothermal Liquid / Valves & Orifices / Flow Control Valves

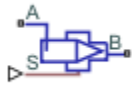

Description

The Needle Valve (IL) block models flow reductions by a needle valve. The valve comprises a conical needle and a round, sharp-edged seat. The needle opens or closes according to the displacement signal at port S. A positive signal retracts the needle and opens the valve.

Opening Area

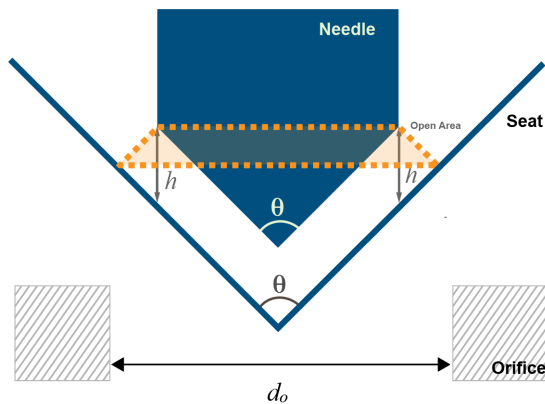

Needle Valve Schematic

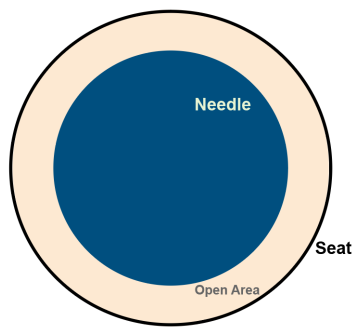

Needle Valve Top View

The opening area of the valve is calculated as:

$$A_{open} = \pi h \sin\left(\frac{\theta}{2}\right) \left[d_0 - \frac{h}{2} \sin(\theta) \right] + A_{leak}$$

where:

- h is the vertical distance between the outer edge of the needle and the seat, as indicated in the schematic above.
- θ is the seat cone angle, which always matches the **Needle cone angle**.
- d_0 is the **Seat orifice diameter**.
- A_{leak} is the **Leakage area**.

The opening area is bounded by the maximum displacement h_{max} :

$$h_{max} = \frac{d_0 \left[1 - \sqrt{1 - \cos\left(\frac{\theta}{2}\right)} \right]}{\sin(\theta)}.$$

For any needle displacement larger than h_{max} , A_{open} is the sum of the maximum orifice area and the **Leakage area**:

$$A_{open} = \frac{\pi}{4} d_0^2 + A_{leak}.$$

For any combination of the signal at port **S** and the needle offset that is less than 0, the minimum valve area is the **Leakage area**.

Numerically-Smoothed Displacement

At the extremes of the orifice opening range, you can maintain numerical robustness in your simulation by adjusting the block **Smoothing factor**. When the smoothing factor is nonzero, a smoothing function is applied to every calculated displacement, but primarily influences the simulation at the extremes of this range.

The normalized orifice opening is:

$$\hat{h} = \frac{h}{h_{max}}.$$

The **Smoothing factor**, s , is applied to the normalized opening:

$$\hat{h}_{smoothed} = \frac{1}{2} + \frac{1}{2} \sqrt{\hat{h}^2 + \left(\frac{s}{4}\right)^2} - \frac{1}{2} \sqrt{(\hat{h} - 1)^2 + \left(\frac{s}{4}\right)^2}.$$

The smoothed opening is:

$$h_{smoothed} = \hat{h}_{smoothed} h_{max}.$$

Mass Flow Rate Equation

Mass is conserved through the valve:

$$\dot{m}_A + \dot{m}_B = 0.$$

The mass flow rate through the valve is calculated as:

$$\dot{m} = \frac{C_d A_{valve} \sqrt{2\bar{\rho}}}{\sqrt{PR_{loss} \left(1 - \left(\frac{A_{valve}}{A_{port}} \right)^2 \right)}} \frac{\Delta p}{\left[\Delta p^2 + \Delta p_{crit}^2 \right]^{1/4}},$$

where:

- C_d is the **Discharge coefficient**.
- A_{valve} is the instantaneous valve open area.
- A_{port} is the **Cross-sectional area at ports A and B**.
- $\bar{\rho}$ is the average fluid density.
- Δp is the valve pressure difference $p_A - p_B$.

The critical pressure difference, Δp_{crit} , is the pressure differential associated with the **Critical Reynolds number**, Re_{crit} , the flow regime transition point between laminar and turbulent flow:

$$\Delta p_{\text{crit}} = \frac{\pi \bar{\rho}}{8 A_{\text{valve}}} \left(\frac{\nu Re_{\text{crit}}}{C_d} \right)^2.$$

Pressure loss describes the reduction of pressure in the valve due to a decrease in area. PR_{loss} is calculated as:

$$PR_{\text{loss}} = \frac{\sqrt{1 - \left(\frac{A_{\text{valve}}}{A_{\text{port}}} \right)^2 (1 - C_d^2)} - C_d \frac{A_{\text{valve}}}{A_{\text{port}}}}{\sqrt{1 - \left(\frac{A_{\text{valve}}}{A_{\text{port}}} \right)^2 (1 - C_d^2)} + C_d \frac{A_{\text{valve}}}{A_{\text{port}}}}.$$

Pressure recovery describes the positive pressure change in the valve due to an increase in area. If you do not wish to capture this increase in pressure, set **Pressure recovery** to Off. In this case, PR_{loss} is 1.

Ports

Conserving

A – Liquid port

isothermal liquid

Liquid entry or exit port to the valve.

B – Liquid port

isothermal liquid

Liquid entry or exit port to the valve.

Input

S – Needle displacement, m

physical signal

Control member displacement in m, specified as a physical signal. A positive signal retracts the needle and opens the valve.

Parameters

Seat orifice diameter – Diameter of seat

5e-3 m (default) | positive scalar

Diameter of the seat orifice.

Needle cone angle — Control member geometry angle

90 deg (default) | positive scalar

Control member geometry angle. Refer to the “Needle Valve Schematic” on page 1-1066 in the valve description.

Needle position when in the seat — Needle offset

0 m (default) | scalar

Needle offset when the valve is closed. A positive, nonzero value indicates a partially open valve. A negative, nonzero value indicates an overlapped valve that remains closed for an initial displacement set by the physical signal at port **S**.

Leakage area — Gap area when in fully closed position

1e-10 m² (default) | positive scalar

Sum of all gaps when the valve is in the fully closed position. Any area smaller than this value is saturated to the specified leakage area. This contributes to numerical stability by maintaining continuity in the flow.

Cross-sectional area at ports A and B — Area at conserving ports

inf m² (default) | positive scalar

Areas at the entry and exit ports **A** and **B**, which are used in the pressure-flow rate equation that determines the mass flow rate through the valve.

Discharge coefficient — Discharge coefficient

0.64 (default) | positive scalar

Correction factor accounting for discharge losses in theoretical flows.

Critical Reynolds number — Upper Reynolds number limit for laminar flow

150 (default) | positive scalar

Upper Reynolds number limit for laminar flow through the orifice.

Smoothing factor — Numerical smoothing factor

0.01 (default) | positive scalar in the range [0,1]

Continuous smoothing factor that introduces a layer of gradual change to the flow response when the valve is in near-open or near-closed positions. Set this value to a nonzero value less than one to increase the stability of your simulation in these regimes.

Pressure recovery — Whether to account for pressure increase in area expansions

Off (default) | On

Whether to account for pressure increase when fluid flows from a region of smaller cross-sectional area to a region of larger cross-sectional area.

See Also

Poppet Valve (IL) | Gate Valve (IL) | Shuttle Valve (IL)

Introduced in R2020a

Orifice (IL)

Constant-area or variable-area orifice in an isothermal system

Library: Simscape / Fluids / Isothermal Liquid / Valves & Orifices / Orifices



Description

The Orifice (IL) block models the flow through a local restriction with a constant or variable opening area. For variable orifices, a control member connected to port **S** sets the opening position. The opening area is parametrized either linearly or by lookup table.

For orifices that open and close based on the displacement of a central spool, see Spool Orifice (IL).

You can enable faulty behavior by setting **Enable faults** to On.

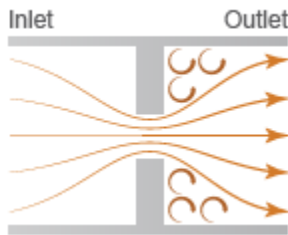

Momentum is conserved through the orifice:

$$\dot{m}_A + \dot{m}_B = \rho v_A A_A + \rho v_B A_B = 0.$$

This momentum balance implies that there is an increase in velocity when there is a decrease in area, and a reduction in velocity when the flow discharges into a larger area. In accordance with the Bernoulli principle, this change in velocity results in a region of lower pressure in the orifice and a higher pressure in the expansion zone. The resulting increase in pressure, which is called *pressure recovery*, depends on the discharge coefficient of the orifice and the ratio of the orifice and port areas.

Constant Orifices

For constant orifices, the orifice area, A_{orifice} , does not change over the course of the simulation.

Using the Constant Area Parameterization

The volumetric flow rate is calculated by:

$$\dot{m} = \frac{C_d A_{\text{orifice}} \sqrt{2\rho}}{\sqrt{PR_{\text{loss}} \left(1 - \left(\frac{A_{\text{orifice}}}{A_{\text{port}}}\right)^2\right)}} \sqrt{p_A - p_B} \approx \frac{C_d A_{\text{orifice}} \sqrt{2\rho}}{\sqrt{PR_{\text{loss}} \left(1 - \left(\frac{A_{\text{orifice}}}{A_{\text{port}}}\right)^2\right)}} \frac{p_A - p_B}{\left[(p_A - p_B)^2 + \Delta p_{\text{crit}}\right]^{1/4}},$$

where:

- C_d is the **Discharge coefficient**.
- $A_{orifice}$ is the instantaneous orifice open area.
- A_{port} is the **Cross-sectional area at ports A and B**.
- $\bar{\rho}$ is the average fluid density.

PR_{loss} and Δp_{crit} are calculated in the same manner for constant and variable orifices and are defined in the “Pressure Loss” on page 1-1074 and “Critical Pressure” on page 1-1074 sections below.

This approximation for \dot{m} and the Local Restriction (IL) block are the same.

Using the Tabulated data - Volumetric flow rate vs. pressure drop Parameterization

The volumetric flow rate is determined from the tabular values of the pressure differential, Δp , which you can provide. If only non-negative values are provided for both the volumetric flow rate and pressure drop vectors, the table will be extrapolated to contain negative values. The volumetric flow rate is interpolated from this extended table.

Variable Orifices

For variable orifices, setting **Opening orientation** to **Positive control member displacement opens orifice** opens the orifice when the signal at **S** is positive, while a **Negative control member displacement opens orifice** orientation opens the orifice when the signal at **S** is negative. In both cases, the signal is positive and the orifice opening is set by the magnitude of the signal.

Using the Linear - Area vs. control member position Parameterization

The orifice area $A_{orifice}$ is based on the control member position and the ratio of orifice area and maximum control member position:

$$A_{orifice} = \frac{(A_{max} - A_{leak})}{\Delta S}(S - S_{min})\varepsilon + A_{leak},$$

where:

- S_{min} is the control member position when the orifice is fully closed.
- ΔS is the **Control member travel between closed and open orifice**.
- A_{max} is the **Maximum orifice area**.
- A_{leak} is the **Leakage area**.
- ε is the **Opening orientation**.

The volumetric flow rate is determined by the pressure-flow rate equation:

$$\dot{m} = \frac{C_d A_{orifice} \sqrt{2\bar{\rho}}}{\sqrt{PR_{loss} \left(1 - \left(\frac{A_{orifice}}{A}\right)^2\right)}} \frac{\Delta p}{[\Delta p^2 + \Delta p_{crit}^2]^{1/4}},$$

where A is the **Cross-sectional area at ports A and B**.

Using the Tabulated data - Area vs. control member position Parameterization

When you use the Tabulated data - Area vs. control member position parameterization, the orifice area $A_{orifice}$ is interpolated from the tabular values of opening area and the control member

position, ΔS , which you can provide. As with the Linear - Area vs. control member position parameterization, the volumetric flow rate is determined by the pressure-flow rate equation:

$$\dot{m} = \frac{C_d A_{orifice} \sqrt{2\rho}}{\sqrt{PR_{loss} \left(1 - \left(\frac{A_{orifice}}{A}\right)^2\right)}} \frac{\Delta p}{[\Delta p^2 + \Delta p_{crit}^2]^{1/4}},$$

where $A_{orifice}$ is:

- A_{max} , the last element of the **Orifice area vector**, if the opening is larger than the maximum specified opening.
- A_{leak} , the first element of the **Orifice area vector**, if the orifice opening is less than the minimum opening.
- $A_{orifice}$ if the calculated area is between the limits of the **Orifice area vector**.

A_{open} is a function of the control member position received at port **S**. The block queries between data points with linear interpolation and uses nearest extrapolation for points beyond the table boundaries.

Using the Tabulated data - Volumetric flow rate vs. control member position and pressure drop Parameterization

The Tabulated data - Volumetric flow rate vs. control member position and pressure drop parameterization interpolates the volumetric flow rate directly from a user-provided volumetric flow rate table, which is based on the control member position and pressure drop over the orifice. The block queries between data points with linear interpolation and uses linear extrapolation for points beyond the table boundaries.

This data can include negative pressure drops and negative opening values. If a negative pressure drop is included in the dataset, the volumetric flow rate will change direction. However, the flow rate will remain unchanged for negative opening values.

Numerically-Smoothed Valve Area

When a linearly-parameterized variable orifice is in the near-open or near-closed position, you can maintain numerical robustness in your simulation by adjusting the block **Smoothing factor**. A smoothing function is applied to all calculated areas, but primarily influences the simulation at the extremes of the valve area.

The normalized area is calculated as:

$$\hat{A} = \frac{(A_{orifice} - A_{leak})}{(A_{max} - A_{leak})}.$$

The **Smoothing factor**, s , is applied to the normalized area:

$$\hat{A}_{smoothed} = \frac{1}{2} + \frac{1}{2} \sqrt{\hat{A}^2 + \left(\frac{s}{4}\right)^2} - \frac{1}{2} \sqrt{(\hat{A} - 1)^2 + \left(\frac{s}{4}\right)^2}.$$

The smoothed valve area is:

$$A_{smoothed} = \hat{A}_{smoothed}(A_{max} - A_{leak}) + A_{leak}.$$

Pressure Loss

Pressure loss describes the reduction of pressure in the valve due to a decrease in area. The pressure loss term, PR_{loss} is calculated as:

$$PR_{loss} = \frac{\sqrt{1 - \left(\frac{A_{orifice}}{A_{port}}\right)^2 (1 - C_d^2)} - C_d \frac{A_{orifice}}{A_{port}}}{\sqrt{1 - \left(\frac{A_{orifice}}{A_{port}}\right)^2 (1 - C_d^2)} + C_d \frac{A_{orifice}}{A_{port}}}$$

Pressure recovery describes the positive pressure change in the valve due to an increase in area. If you do not wish to capture this increase in pressure, set **Pressure recovery** to Off. In this case, PR_{loss} is 1.

Critical Pressure

The critical pressure difference, Δp_{crit} is the pressure differential associated with the **Critical Reynolds number**, Re_{crit} which is the point of transition between laminar and turbulent flow in the fluid:

$$\Delta p_{crit} = \frac{\pi \bar{\rho}}{8 A_{orifice}} \left(\frac{\nu Re_{crit}}{C_d} \right)^2$$

Faulty Behavior

When **Orifice type** is set to Variable and faults are enabled, the orifice open area becomes stuck at a specified value in response to one or both of these triggers:

- Simulation time — Faulting occurs at a specified time.
- Simulation behavior — Faulting occurs in response to an external trigger. This exposes port T.

Three fault options are available in the **Opening area when faulted** parameter:

- Closed — The orifice freezes at its smallest value, depending on the **Orifice parameterization**:
 - When **Orifice parameterization** is set to Linear - Area vs. control member position, the orifice freezes at the **Leakage area**.
 - When **Orifice parameterization** is set to Tabulated data - Area vs. control member position, the orifice freezes at the first element of the **Orifice area vector**.
 - When **Orifice parameterization** is set to Tabulated data - Volumetric flow rate vs. control member position and pressure drop, the orifice freezes at the first row of the **Volumetric flow rate table, q(s,dp)**.
- Open — The orifice freezes at its largest value, depending on the **Orifice parameterization**:
 - When **Orifice parameterization** is set to Linear - Area vs. control member position, the orifice freezes at the **Maximum orifice area**.
 - When **Orifice parameterization** is set to Tabulated data - Area vs. control member position, the orifice freezes at the last element of the **Orifice area vector**.
 - When **Orifice parameterization** is set to Tabulated data - Volumetric flow rate vs. control member position and pressure drop, the orifice freezes at the last row of the **Volumetric flow rate table, q(s,dp)**.

- **Maintain at last value** — The orifice seizes at the open area or volumetric flow rate when the trigger occurs.

Due to numerical smoothing at the extremes of the orifice area, the minimum area applied is larger than the parameter value, and the maximum is smaller than the parameter value, in proportion to the **Smoothing factor** value.

Once triggered, the orifice remains at the faulted area for the rest of the simulation.

You can set the block to issue a fault report as a warning or error message in the Simulink Diagnostic Viewer with the **Reporting when fault occurs** parameter.

Ports

Conserving

A — Liquid port

isothermal liquid

Liquid entry or exit point to the orifice.

B — Liquid port

isothermal liquid

Liquid entry or exit point to the orifice.

Input

S — Control member displacement

physical signal

Control member displacement that sets orifice opening.

T — External fault trigger

physical signal

Physical signal port for an external fault trigger. Triggering occurs when the value is greater than 0.5. There is no unit associated with the trigger value.

Dependencies

This port is visible when **Enable faults** is set to On and **Enable external fault trigger** is set to On.

Parameters

Parameters

Orifice type — Type of orifice

Variable (default) | Constant

Type of orifice, defined by the orifice area. When set to *Variable*, the orifice area varies according to the input signal received at port **S**.

Orifice parameterization — Method of calculating orifice area

Orifice Area (default) | Tabulated data - volumetric flow rate vs. pressure drop | Linear - area vs. control member position | Tabulated data - Area vs. control

member position | Tabulated data - Volumetric flow rate vs. control member position and pressure drop

Method of calculating orifice area over simulation. When **Orifice type** is set to Constant, there are two parameterization options.

- **Orifice area** (default). The assigned area does not change over the simulation.
- **Tabulated data - Volumetric flow rate vs. pressure drop**. The area remains constant, but the volumetric flow rate through the orifice can vary. This value is interpolated directly from the **Volumetric flow rate vector** and the **Pressure drop vector** dataset.

When the **Orifice type** is set to Variable, there are three parameterization options.

- **Linear - Area vs. control member position**. Area is determined by a linear relationship to the control member position with respect to a fully open or fully closed orifice. The position is set by a varying physical signal at port **S**.
- **Tabulated data - Area vs. control member position**. The opening area is interpolated from the **Control member position vector** and the **Orifice area vector** based on the control member position received at port **S**.
- **Tabulated data - Volumetric flow rate vs. control member position and pressure drop**. The volumetric flow rate is directly interpolated from the user- provided **Control member position vector, s, Pressure drop vector, dp, and Volumetric flow rate table, q(s,dp)** parameters based on the control member position received at port **S** and the pressure drop across ports **A** and **B**.

Orifice area – Area of orifice opening

1e-3 m² (default) | positive scalar

Cross-sectional area of the orifice opening.

Dependencies

To enable this parameter, set **Orifice type** to Constant and **Orifice parameterization** to Orifice area.

Pressure drop vector – Vector of differential pressure values for tabular parameterization

[-4, -3, -2, -1, -.5, 0, .5, 1, 2, 3, 4] MPa (default) | 1-by-*n* vector

Vector of pressure differential values for the tabular parameterization of volumetric flow rate. The values in this vector correspond one-to-one to values in the **Volumetric flow rate vector** parameter. The pressure drop vector values are listed in ascending order. The volumetric flow rate is interpolated directly from the **Volumetric flow rate vector**, which depends on the **Pressure drop vector** parameter.

Dependencies

To enable this parameter, set **Orifice type** to Constant and **Orifice parameterization** to Tabulated data - Volumetric flow rate vs. pressure drop.

Volumetric flow rate vector – Vector of volumetric flow rate values

[-2.44, -2.12, -1.68, -1.22, -.84, 0, .85, 1.21, 1.7, 2.09, 2.41] .* 1e-3 m³/s (default) | 1-by-*n* vector

Vector of volumetric flow rate values for the tabular parameterization of volumetric flow rate. The values in this vector correspond one-to-one to values in the **Pressure drop vector**. The volumetric flow rate is interpolated directly from the provided **Volumetric flow rate vector**, which depends on the **Pressure drop vector** parameter.

Dependencies

To enable this parameter, set **Orifice type** to Constant and **Orifice parameterization** to Tabulated data - Volumetric flow rate vs. pressure drop.

Control member position at closed orifice – Control member offset

0 m (default) | scalar

Initial control member offset when the variable orifice is fully closed.

Dependencies

To enable this parameter, set **Orifice type** to Variable.

Control member travel between closed and open orifice – Control member maximum stroke

5e-3 m (default) | positive scalar

Maximum distance the control member travels between closed and open orifice. The orifice is fully open at the sum of the **Control member position at closed orifice** and **Control member travel between closed and open orifice**,

Dependencies

To enable this parameter, set **Orifice type** to Variable and **Orifice parameterization** to Linear - Area vs. control member position.

Maximum orifice area – Maximum orifice opening area

1e-4 m² (default) | positive scalar

Maximum orifice area experienced during simulation. When using Tabulated data - Area vs. control member position, the maximum orifice area is the last element of the **Orifice area vector**.

Dependencies

To enable this parameter, set **Orifice type** to Variable and **Orifice parameterization** to Linear - Area vs. control member position.

Leakage area – Orifice gap area when in fully closed position

1e-10 m² (default) | positive scalar

Sum of all gaps when the valve is in fully closed position. Any area smaller than this value is maintained at the specified leakage area. This parameter contributes to numerical stability by maintaining continuity in the flow.

Dependencies

To enable this parameter, set **Orifice type** to Variable and **Orifice parameterization** to Linear - Area vs. control member position.

Control member position vector – Vector of control member positions

[0, .002, .004, .007, .017] m (default) | 1-by-*n* vector

Vector of control member positions for the tabular parameterization of orifice area. The vector elements correspond one-to-one to the values in the **Orifice area vector**. The vector elements are listed in ascending order and the first element must be 0. The orifice opening area is interpolated from the **Orifice area vector**, which depends on the **Control member position vector** parameter.

Dependencies

To enable this parameter, set **Orifice type** to Variable and **Orifice parameterization** to Tabulated data - Area vs. control member position.

Orifice area vector – Vector of orifice opening area values

[1e-09, 2.0352e-07, 4.0736e-05, .00011438, .00034356] m² (default) | 1-by-*n* vector

Vector of orifice area values for the tabular parameterization of orifice area. The values in this vector correspond one-to-one with the elements in the **Control member position vector**. The first element of this vector is the orifice leakage area and the last element is the maximum orifice area. The orifice opening area is interpolated from the **Orifice area vector**, which depends on the **Control member position vector**.

Dependencies

To enable this parameter, set **Orifice type** to Variable and **Orifice parameterization** to Tabulated data - Area vs. control member position.

Cross-sectional area at ports A and B – Area at orifice entry or exit

inf m² (default) | positive scalar

Cross-sectional area at the entry and exit ports **A** and **B**. This area is used in the pressure-flow rate equation that determines the mass flow rate through the orifice.

Dependencies

To enable this parameter, set either:

- **Orifice type** to Variable and **Orifice parameterization** to either Linear - Area vs. control member position or Tabulated data - Area vs. control member position.
- **Orifice type** to Constant and **Orifice parameterization** to Orifice area.

Opening orientation – Direction of member movement that opens the orifice

Positive control member displacement opens orifice (default) | Negative control member displacement opens orifice

Direction of member displacement that opens a variable orifice. A positive orientation means that a positive signal at **S** opens the orifice. A negative orientation means that a negative signal at **S** opens the orifice.

Dependencies

To enable this parameter, set **Orifice type** to Variable.

Discharge coefficient – Discharge coefficient

0.64 (default) | positive scalar in the range of [0,1]

Correction factor that accounts for discharge losses in theoretical flows.

Dependencies

To enable this parameter, set either:

- **Orifice type** to Variable and **Orifice parameterization** to either Linear - Area vs. control member position or Tabulated data - Area vs. control member position.
- **Orifice type** to Constant and **Orifice parameterization** to Orifice area.

Critical Reynolds number — Upper Reynolds number limit for laminar flow

150 (default) | positive scalar

Upper Reynolds number limit for laminar flow through the orifice.

Dependencies

To enable this parameter, set either:

- **Orifice type** to Variable and **Orifice parameterization** to either Linear - Area vs. control member position or Tabulated data - Area vs. control member position.
- **Orifice type** to Constant and **Orifice parameterization** to Orifice area.

Smoothing factor — Numerical smoothing factor

0.01 (default) | positive scalar in the range [0,1]

Continuous smoothing factor that introduces a layer of gradual change to the flow response when the orifice is in near-open or near-closed positions. Set this value to a nonzero value less than one to increase the stability of your simulation in these regimes.

Pressure recovery — Whether to account for pressure increase in area expansions

On (default) | Off

Whether to account for pressure increase when fluid flows from a region of smaller cross-sectional area to a region of larger cross-sectional area. This increase in pressure is not captured when **Pressure recovery** is set on Off.

Dependencies

To enable this parameter, set either:

- **Orifice type** to Variable and **Orifice parameterization** to either Linear - Area vs. control member position or Tabulated data - Area vs. control member position.
- **Orifice type** to Constant and **Orifice parameterization** to Orifice area.

Control member position vector, s — Vector of opening values

[0, .002, .004, .007, .017] m (default) | 1-by- n vector

Vector of control member positions for tabular parametrization of volumetric flow rate. The control member position vector forms an independent axis with the **Pressure drop vector, dp** parameter for the 2-D dependent **Volumetric flow rate table, $q(s,dp)$** parameter. A positive displacement corresponds to valve opening. The values are listed in ascending order and the first element must be 0. Linear interpolation is employed between table data points.

Dependencies

To enable this parameter, set **Orifice type** to Variable and **Orifice parameterization** to Tabulated data - Volumetric flow rate vs. control member position and pressure drop.

Pressure drop vector, dp — Vector of pressure drop values

[.3, .5, .7] MPa (default) | 1-by-*n* vector

Vector of pressure drop values for tabular parametrization of volumetric flow rate. The pressure drop vector forms an independent axis with the **Control member position vector, s** parameter for the 2-D dependent **Volumetric flow rate table, q(s,dp)** parameter. The values are listed in ascending order and must be greater than 0. Linear interpolation is employed between table data points.

Dependencies

To enable this parameter, set **Orifice type** to Variable and **Orifice parameterization** to Tabulated data - Volumetric flow rate vs. control member position and pressure drop.

Volumetric flow rate table, q(s,dp) — Array of volumetric flow rate values

[1.7e-05, 2e-05, 2.6e-05; .0035, .0045, .0053; .7, .9, 1.06; 1.96, 2.5, 3; 6, 7.7, 9.13] .* 1e-3 m³/s (default) | *M*-by-*N* matrix

M-by-*N* matrix of volumetric flow rates based on independent values of pressure drop and control member position. *M* and *N* are the sizes of the corresponding vectors:

- *M* is the number of elements in the **Pressure drop vector, dp** parameter.
- *N* is the number of elements in the **Control member position vector, s** parameter.

Dependencies

To enable this parameter, set **Orifice type** to Variable and **Orifice parameterization** to Tabulated data - Volumetric flow rate vs. control member position and pressure drop.

Faults**Enable faults — Fault option**

Off (default) | On

Enable externally or temporally triggered faults. When faulting occurs, the valve area normally set by the opening parameterization will be set to the value specified in the **Opening area when faulted** parameter.

Dependencies

To enable this parameter, set **Orifice type** to Variable.

Opening area when faulted — Set faulted area

Closed (default) | Open | Maintain at last value

Sets the faulted orifice area. You can choose for the orifice to seize at the fully closed or fully open position, or at the valve area when faulting is triggered.

Dependencies

To enable this parameter, set **Orifice type** to Variable**Enable faults** to On.

Enable external fault trigger – External trigger option

Off (default) | On

Enables port **T**. A physical signal at port **T** that is greater than 0.5 triggers faulting.

Dependencies

To enable this parameter, set **Orifice type** to Variable**Enable faults** to On.

Enable temporal fault trigger – Temporal trigger option

Off (default) | On

Enables fault triggering at a specified time. When the **Simulation time for fault event** is reached, the orifice area will be set to the value specified in the **Opening area when faulted** parameter.

Dependencies

To enable this parameter, set **Orifice type** to Variable**Enable faults** to On.

Simulation time for fault event – Time at which faulting is triggered

5 s (default) | positive scalar

When the **Simulation time for fault event** is reached, the orifice area is set to the value specified in the **Opening area when faulted** parameter.

Dependencies

To enable this parameter, set set **Orifice type** to Variable, **Enable faults** to On, and **Enable temporal fault trigger** to On.

Reporting when fault occurs – Fault condition report

None (default) | Warning | Error

Reporting preference for the fault condition. When reporting is set to **Warning** or **Error**, a message is displayed in the Simulink Diagnostic Viewer. When **Error** is selected, the simulation will stop if faulting occurs.

Dependencies

To enable this parameter, set **Orifice type** to Variable**Enable faults** to On.

See Also

Spool Orifice (IL) | Variable Overlapping Orifice (IL) | Annular Leakage (IL) | Local Restriction (IL)

Introduced in R2020a

Orifice ISO 6358 (G)

Flow restriction of fixed area modeled per ISO 6358

Library: Simscape / Fluids / Gas / Valves & Orifices



Description

The Orifice ISO 6358 (G) block models the pressure loss incurred in a gas network due to a purely resistive element of fixed size—such as a flow restriction, an orifice, or a valve—using the methods outlined in the ISO 6358 standard. These methods are widely used in industry in the measurement and reporting of gas flow characteristics. The availability of data on the coefficients of the ISO formulas makes the ISO parameterizations useful when component geometries are unavailable or cumbersome to specify.

Orifice Parameterizations

The default orifice parameterization is based on the most recommended of the ISO 6358 methods: one based on the *sonic conductance* of the resistive element at steady state. The sonic conductance measures the ease with which a gas can flow when *choked*, a condition in which the flow velocity is at its theoretical maximum (the local speed of sound). Choking occurs when the ratio between downstream and upstream pressures reaches a critical value known as the *critical pressure ratio*.

The remaining parameterizations are formulated in terms of alternative measures of flow capacity: the flow coefficient (in either of its forms, C_v or K_v) or the size of the flow restriction. The flow coefficient measures the ease with which a gas can flow when driven by a certain pressure differential. The definition of C_v differs from that of K_v in the standard pressure and temperature established in its measurement and in the physical units used in its expression:

- C_v is measured at a generally accepted temperature of 60°F and pressure drop of 1 PSI; it is expressed in imperial units of US gpm. This is the flow coefficient used in the model when the **Orifice parameterization** block parameter is set to `Cv coefficient (USCS)`.
- K_v is measured at a generally accepted temperature of 15°C and pressure drop of 1 bar; it is expressed in metric units of m³/h. This is the flow coefficient used in the model when the **Orifice parameterization** block parameter is set to `Kv coefficient (SI)`.

Mass Balance

The volume of fluid inside the resistive element, and therefore the mass of the same, is assumed to be very small and it is, for modeling purposes, ignored. As a result, no amount of fluid can accumulate there. By the principle of conservation of mass, the mass flow rate into the valve through one port must therefore equal that out of the valve through the other port:

$$\dot{m}_A + \dot{m}_B = 0,$$

where \dot{m} is defined as the mass flow rate *into* the valve through the port indicated by the subscript (**A** or **B**).

Momentum Balance

The causes of the pressure losses incurred in the passages of the resistive element are ignored in the block. Whatever their natures—sudden area changes, flow passage contortions—only their cumulative effect is considered during simulation. It is this cumulative effect that the sonic conductance in the default orifice parameterization captures in a model. If a different parameterization is selected, the coefficients on which it is based are converted into the parameters of the default parameterization; the mass flow rate calculation is then carried out as described in Sonic Conductance Parameterization.

Sonic Conductance Parameterization

In a choked flow, the mass flow rate through the resistive element is calculated as:

$$\dot{m}_{\text{ch}} = C\rho_0 p_{\text{in}} \sqrt{\frac{T_0}{T_{\text{in}}}},$$

where:

- C is the sonic conductance inside the resistive element.
- ρ is the gas density, here at standard conditions (subscript 0, 1.185 kg/m³).
- p is the absolute gas pressure, here corresponding to the inlet (in).
- T is the gas temperature at the inlet (subscript in) or at standard conditions (subscript 0, 293.15 K).

In a subsonic and turbulent flow, the mass flow rate calculation becomes:

$$\dot{m}_{\text{tur}} = C\rho_0 p_{\text{in}} \sqrt{\frac{T_0}{T_{\text{in}}}} \left[1 - \left(\frac{p_r - b_{\text{cr}}}{1 - b_{\text{cr}}} \right)^2 \right]^m,$$

where:

- p_r is the ratio between downstream pressure (p_{out}) and upstream pressure (p_{in}) (each measured against absolute zero):

$$p_r = \frac{p_{\text{out}}}{p_{\text{in}}}$$

- b_{cr} is the critical pressure ratio at which the gas flow first begins to choke.
- m is the *subsonic index*, an empirical coefficient used to more accurately characterize the behavior of subsonic flows.

In a subsonic and laminar flow, the mass flow rate calculation changes to:

$$\dot{m}_{\text{lam}} = C\rho_0 \left(\frac{p_{\text{out}} - p_{\text{in}}}{1 - b_{\text{lam}}} \right) \sqrt{\frac{T_0}{T_{\text{in}}}} \left[1 - \left(\frac{b_{\text{lam}} - b_{\text{cr}}}{1 - b_{\text{cr}}} \right)^2 \right]^m,$$

where b_{lam} is the critical pressure ratio at which the flow transitions between laminar and turbulent regimes. Combining the calculations for the three flow regimes into a piecewise function gives across all pressure ratios:

$$\dot{m} = \begin{cases} \dot{m}_{\text{lam}}, & \text{if } b_{\text{lam}} \leq p_r < 1 \\ \dot{m}_{\text{tur}}, & \text{if } b_{\text{cr}} \leq p_r < b_{\text{lam}}, \\ \dot{m}_{\text{ch}}, & \text{if } p_r < b_{\text{cr}} \end{cases}$$

Conversions to Sonic Conductance

If the orifice parameterization is set to Cv coefficient (USCS), the parameters of the mass flow rate calculation are set as follows:

- **Sonic conductance:** $C = 4E-8 * C_v m^3/(s*Pa)$
- **Critical pressure ratio:** $b_{cr} = 0.3$
- **Subsonic index:** $m = 0.5$

If the Kv coefficient (SI) parameterization is used:

- **Sonic conductance:** $C = 4.78E-8 * K_v m^3/(s*Pa)$
- **Critical pressure ratio:** $b_{cr} = 0.3$
- **Subsonic index:** $m = 0.5$

For the Restriction area parameterization:

- **Sonic conductance:** $C = 0.128 * 4 S_R/\pi L/(s*\text{bar})$, where S is the flow area in the resistive element (subscript R).
- **Critical pressure ratio:** $b_{cr} = 0.41 + 0.272 (S_R/S_P)^{0.25}$
- **Subsonic index:** $m = 0.5$

Energy Balance

The resistive element is modeled as an adiabatic component. No heat exchange can occur between the fluid and the wall that surrounds it. No work is done on or by the fluid as it traverses from inlet to outlet. With these assumptions, energy can flow by advection only, through ports **A** and **B**. By the principle of conservation of energy, the sum of the port energy flows must then always equal zero:

$$\phi_A + \phi_B = 0,$$

where ϕ is defined as the energy flow rate *into* the valve through one of the ports (**A** or **B**).

Ports

Conserving

A — Flow passage

gas

Opening through which the flow can enter or exit the flow resistance. Which of the ports serves as inlet and which as outlet depends on the direction of flow.

B — Flow passage

gas

Opening through which the flow can enter or exit the flow resistance. Which of the ports serves as inlet and which as outlet depends on the direction of flow.

Parameters

Orifice parameterization — Parameterization by which to specify the flow characteristics of the orifice

Sonic conductance (default) | Cv coefficient (USCS) | Kv coefficient (S) | Restriction area

Choice of ISO method to use in the calculation of mass flow rate. All calculations are based on the Sonic conductance parameterization. If a different parameterization is selected, the coefficients that characterize it are converted into sonic conductance, critical pressure ratio, and subsonic index.

Sonic conductance — Measure of flow rate capacity in the choked flow regime

1.6 l/(s*bar) (default) | positive scalar in units of volume/(time*pressure)

Ratio, measured at the onset of choking, of the mass flow rate through the resistive element to the product of the upstream pressure and mass density at standard conditions (defined in ISO8778). This parameter determines the maximum flow rate allowed at a given upstream pressure.

Critical pressure ratio — Ratio of downstream and upstream pressures at which the flow first chokes

0.3 (default) | positive unitless scalar

Pressure ratio at which flow first begins to choke and the flow velocity reaches its maximum, given by the local speed of sound. The pressure ratio is the fraction of the absolute pressure downstream of the resistive element over the absolute pressure upstream of the same component.

Subsonic index — Exponent used to more accurately characterize mass flow in the subsonic flow regime

0.5 (default) | positive unitless scalar

Exponent used to more accurately calculate the mass flow rate in the subsonic flow regime as described in ISO 6358.

Cv coefficient (USCS) — Flow coefficient expressed in US customary units

0.4 (default) | positive unitless scalar

Flow coefficient expressed in US customary units of ft³/min as defined in NFPA T3.21.3. This parameter measures the ease with which the gas traverses the resistive element when driven by a pressure differential. See the block description for the correspondence between these parameters.

Kv coefficient (SI) — Flow coefficient expressed in SI units

0.3 (default) | positive unitless scalar

Flow coefficient expressed in SI units of L/min. This parameter measures the ease with which the gas traverses the resistive element when driven by a pressure differential. See the block description for the correspondence between these parameters.

Restriction area — Flow area of the local restriction

1e-5 m (default) | positive scalar in units of area

Area normal to the direction of flow at the point of shortest aperture. The restriction area is converted into an equivalent sonic conductance and critical pressure ratio for use in calculations of mass flow rate. See the block description for detail on the conversion.

Cross-sectional area at ports A and B — Flow area at the gas ports

0.01 m² (default) | positive scalar in units of area

Area normal to the flow path at each port. The ports are assumed to be equal in size. The flow area specified here should match those of the inlets of those components to which the resistive element connects.

Laminar flow pressure ratio — Pressure ratio at which flow transitions between laminar and turbulent regimes

0.999 (default) | positive unitless scalar

Pressure ratio at which flow transitions between laminar and turbulent flow regimes. The pressure ratio is the fraction of the absolute pressure downstream of the resistive element over the absolute pressure upstream of the same component. Typical values range from 0.995 to 0.999.

Reference temperature — ISO 8778 reference temperature

293.15 K (default) | scalar in units of temperature

Temperature at standard reference atmosphere, defined as 293.15 K in ISO 8778.

Reference density — ISO 8778 reference density

1.185 (default) | positive scalar in units of mass/volume

Density at standard reference atmosphere, defined as 1.185 kg/m³ in ISO 8778.

References

[1] P. Beater, *Pneumatic Drives*, Springer-Verlag Berlin Heidelberg, 2007.

Extended Capabilities**C/C++ Code Generation**

Generate C and C++ code using Simulink® Coder™.

See Also

Variable Orifice ISO 6358 (G)

Introduced in R2018a

Variable Orifice ISO 6358 (G)

Flow restriction of variable area modeled per ISO 6358

Library: Simscape / Fluids / Gas / Valves & Orifices



Description

The Variable Orifice ISO 6358 (G) block models the pressure loss incurred in a gas network due to a purely resistive element of variable size—such as a controlled flow restriction, orifice, or valve—using the methods outlined in the ISO 6358 standard. These methods are used in industry in the measurement and reporting of gas flow characteristics. The availability of data on the coefficients of the ISO formulas makes the ISO parameterizations useful when component geometries are unavailable or cumbersome to specify.

Orifice Parameterizations

The default orifice parameterization is based on the most recommended of the ISO 6358 methods: one based on the *sonic conductance* of the resistive element at steady state. The sonic conductance measures the ease with which a gas can flow when *choked*, a condition in which the flow velocity is at its theoretical maximum (the local speed of sound). Choking occurs when the ratio between downstream and upstream pressures reaches a critical value known as the *critical pressure ratio*.

The remaining parameterizations are formulated in terms of alternative measures of flow capacity: the flow coefficient (in either of its forms, C_v or K_v) or the size of the flow restriction. The flow coefficient measures the ease with which a gas can flow when driven by a certain pressure differential. The definition of C_v differs from that of K_v in the standard pressure and temperature established in its measurement and in the physical units used in its expression:

- C_v is measured at a generally accepted temperature of 60°F and pressure drop of 1 PSI; it is expressed in imperial units of US gpm. This is the flow coefficient used in the model when the **Orifice parameterization** block parameter is set to `Cv coefficient (USCS)`.
- K_v is measured at a generally accepted temperature of 15°C and pressure drop of 1 bar; it is expressed in metric units of m³/h. This is the flow coefficient used in the model when the **Orifice parameterization** block parameter is set to `Kv coefficient (SI)`.

Two values are required for the chosen measure of flow capacity (that for which the orifice parameterization is named): a *maximum* and a *minimum*. The maximum corresponds to a valve open to full capacity; this is the value for which the coefficient data are frequently reported in valve data sheets. The minimum corresponds to a valve closed tight, when only leakage flow remains, if any at all. This lower bound serves primarily to ensure the numerical robustness of the model. Its exact value is less important than its being a (generally very small) number greater than zero.

Opening Parameterizations

The sonic conductance and (in certain settings) the critical pressure ratio are determined during simulation from the input at port **L**. This input is the *control signal* and it is, in some valves, associated with *stroke* or *lift percent*. The control signal can range in value from 0 to 1. If a lesser or

greater value is specified, it is adjusted to the nearest of the two limits. In other words, the signal is *saturated* at 0 and 1.

If the orifice parameterization is changed from its default of **Sonic conductance**, the sonic conductance and critical pressure ratio are determined as linear functions of the chosen measure of flow capacity. This alternative measure is in turn obtained from the control signal. Calculations of mass flow rate are carried out as before, using the equations described in "Sonic Conductance Parameterization".

The conversion from a control signal to the chosen measure of flow capacity depends on the *opening* parameterization selected in the block. Flow is always maximally restricted when the control signal is 0 and minimally so when the control signal is 1. However, in between, the flow rate achieved within the resistive element depends on whether the opening parameterization is linear or based on tabulated data:

- **Linear** — The measure of flow capacity (sonic conductance, Cv coefficient, other) is proportional to the control signal at port **L**. The two vary in tandem until the control signal either drops below 0 (flow is maximally restricted) or rises above 1 (flow is minimally restricted). As the control signal rises from 0 to 1, the measure of flow capacity scales from its specified minimum to its specified maximum.

In the conversion to the parameters of the sonic conductance parameterization, both the critical pressure ratio and the subsonic index are treated as constants, each independent of the control signal.

- **Tabulated data** — The measure of flow capacity is a tabulated function of the control signal at port **L**. This function is based on a one-way lookup table with the control signal corresponding to the abscissa and the measure of flow capacity to the ordinate. The tabulated data must be specified such that the measure of flow capacity increases monotonically with the control signal.

In the conversion to the parameters of the sonic conductance parameterization, the critical pressure ratio is treated as a function of the control signal while the subsonic index is treated as a constant.

Mass Balance

The volume of fluid inside the resistive element, and therefore the mass of the same, is assumed to be very small and it is, for modeling purposes, ignored. As a result, no amount of fluid can accumulate there. By the principle of conservation of mass, the mass flow rate into the valve through one port must therefore equal that out of the valve through the other port:

$$\dot{m}_A + \dot{m}_B = 0,$$

where \dot{m} is defined as the mass flow rate *into* the valve through the port indicated by the subscript (**A** or **B**).

Momentum Balance

The causes of the pressure losses incurred in the passages of the resistive element are ignored in the block. Whatever their natures—sudden area changes, flow passage contortions—only their cumulative effect is considered during simulation. It is this cumulative effect that the sonic conductance in the default orifice parameterization captures in a model. If a different parameterization is selected, the coefficients on which it is based are converted into the parameters of the default parameterization; the mass flow rate calculation is then carried out as described in Sonic Conductance Parameterization.

Sonic Conductance Parameterization

In a choked flow, the mass flow rate through the resistive element is calculated as:

$$\dot{m}_{\text{ch}} = C\rho_0 p_{\text{in}} \sqrt{\frac{T_0}{T_{\text{in}}}},$$

where:

- C is the sonic conductance inside the resistive element.
- ρ is the gas density, here at standard conditions (subscript 0, 1.185 kg/m³).
- p is the absolute gas pressure, here corresponding to the inlet (subscript in).
- T is the gas temperature at the inlet (subscript in) or at standard conditions (0, 293.15 K).

In a subsonic and turbulent flow, the mass flow rate calculation becomes:

$$\dot{m}_{\text{tur}} = C\rho_0 p_{\text{in}} \sqrt{\frac{T_0}{T_{\text{in}}}} \left[1 - \left(\frac{p_r - b_{\text{cr}}}{1 - b_{\text{cr}}} \right)^2 \right]^m,$$

where:

- p_r is the ratio between downstream pressure (p_{out}) and upstream pressure (p_{in}) (each measured against absolute zero):

$$p_r = \frac{p_{\text{out}}}{p_{\text{in}}}$$

- b_{cr} is the critical pressure ratio at which the gas flow first begins to choke.
- m is the *subsonic index*, an empirical coefficient used to more accurately characterize the behavior of subsonic flows.

In a subsonic and laminar flow, the mass flow rate calculation changes to:

$$\dot{m}_{\text{lam}} = C\rho_0 \left(\frac{p_{\text{out}} - p_{\text{in}}}{1 - b_{\text{lam}}} \right) \sqrt{\frac{T_0}{T_{\text{in}}}} \left[1 - \left(\frac{b_{\text{lam}} - b_{\text{cr}}}{1 - b_{\text{cr}}} \right)^2 \right]^m,$$

where b_{lam} is the critical pressure ratio at which the flow transitions between laminar and turbulent regimes. Combining the calculations for the three flow regimes into a piecewise function gives across all pressure ratios:

$$\dot{m} = \begin{cases} \dot{m}_{\text{lam}}, & \text{if } b_{\text{lam}} \leq p_r < 1 \\ \dot{m}_{\text{tur}}, & \text{if } b_{\text{cr}} \leq p_r < b_{\text{lam}}, \\ \dot{m}_{\text{ch}}, & \text{if } p_r < b_{\text{cr}} \end{cases}$$

Conversions to Sonic Conductance

If the orifice parameterization is set to Cv coefficient (USCS), the parameters of the mass flow rate calculation are set as follows:

- **Sonic conductance:** $C = 4\text{E-}8 * C_v \text{ m}^3/(\text{s}*\text{Pa})$
- **Critical pressure ratio:** $b_{\text{cr}} = 0.3$

- **Subsonic index:** $m = 0.5$

If the K_v coefficient (SI) parameterization is used:

- **Sonic conductance:** $C = 4.78E-8 * K_v m^3/(s*Pa)$
- **Critical pressure ratio:** $b_{cr} = 0.3$
- **Subsonic index:** $m = 0.5$

For the Restriction area parameterization:

- **Sonic conductance:** $C = 0.128 * 4 S_R/\pi L/(s*\text{bar})$, where S is the flow area in the resistive element (subscript R).
- **Critical pressure ratio:** $b_{cr} = 0.41 + 0.272 (S_R/S_P)^{0.25}$
- **Subsonic index:** $m = 0.5$

Energy Balance

The resistive element is modeled as an adiabatic component. No heat exchange can occur between the fluid and the wall that surrounds it. No work is done on or by the fluid as it traverses from inlet to outlet. With these assumptions, energy can flow by advection only, through ports **A** and **B**. By the principle of conservation of energy, the sum of the port energy flows must then always equal zero:

$$\phi_A + \phi_B = 0,$$

where ϕ is defined as the energy flow rate *into* the valve through one of the ports (**A** or **B**).

Ports

Input

L — Orifice opening, unitless

physical signal

Control signal by means of which to specify the opening (in some valves associated with *stroke* or *lift percent*) of the orifice. The orifice is fully closed at a value of 0 and fully open at a value of 1.

Conserving

A — Flow passage

gas

Opening through which the flow can enter or exit the flow resistance. Which of the ports serves as inlet and which as outlet depends on the direction of flow.

B — Flow passage

gas

Opening through which the flow can enter or exit the flow resistance. Which of the ports serves as inlet and which as outlet depends on the direction of flow.

Parameters

Orifice parameterization — Parameterization by which to specify the flow characteristics of the orifice

Sonic conductance (default) | Cv coefficient (USCS)Kv coefficient (S)Restriction area

Choice of ISO method to use in the calculation of mass flow rate. All calculations are based on the Sonic conductance parameterization. If a different parameterization is selected, the coefficients that characterize it are converted into sonic conductance, critical pressure ratio, and subsonic index.

Opening parameterization — Method of conversion from control signal to measure of flow capacity

Linear (default) | Tabulated data

Method by which to convert the control signal specified at port **L** to the chosen measure of flow capacity (sonic conductance, either of the flow coefficients, or restriction area). See the block description for more detail on the opening parameterizations.

Sonic conductance at maximum flow — Sonic conductance corresponding to a maximally open component

1.6 L/s/bar (default) | positive scalar in units of volume/(time*pressure)

Value of the sonic conductance when the control signal specified at port **L** is 1. The cross-sectional area available for flow is then at a maximum. During simulation the sonic conductance at intermediate control signals (those valued between 0 and 1) is set by linear interpolation between this value and that of the **Sonic conductance at leakage flow** parameter.

Sonic conductance at leakage flow — Sonic conductance corresponding to a maximally closed component

1e-5 L/s/bar (default) | positive scalar in units of volume/(time*pressure)

Value of the sonic conductance when the control signal specified at port **L** is 0. The cross-sectional area available for flow is then at a minimum, with only a negligible leakage flow remaining between the ports. The primary purpose of this parameter is to ensure the numerical robustness of the model during simulation. Its exact value is less important than its being a very small number greater than zero.

During simulation the sonic conductance at intermediate control signals (those valued between 0 and 1) is set by linear interpolation between this value and that of the **Sonic conductance at maximum flow** parameter.

Critical pressure ratio — Ratio of downstream and upstream pressures at which the flow first chokes

0.3 (default) | positive unitless scalar

Pressure ratio at which flow first begins to choke and the flow velocity reaches its maximum, given by the local speed of sound. The pressure ratio is the fraction of the absolute pressure downstream of the resistive element over the absolute pressure upstream of the same component.

Opening fraction vector — Control signal values at which to specify the tabulated parameter data

0 : 0.2 1 (default) | vector of positive unitless numbers

Vector of control signal values at which to specify the chosen measure of flow capacity (sonic conductance, either of the flow coefficients, or restriction area). The control signal is bounded at 0 and 1, with each value in this range corresponding to an opening fraction of the resistive element. The greater the value, the greater the opening and (generally) the easier the flow.

The opening fractions must increase monotonically across the vector from left to right. The size of this vector must be the same as that of the chosen measure of flow capacity (**Sonic conductance vector**, **Cv coefficient (USCS) vector**, other).

Sonic conductance vector — Sonic conductances corresponding to the values in the opening fraction vector

[1e-05, .32, .64, .96, 1.28, 1.6] L/s/bar (default) | vector of positive numbers in units of volume/(time*pressure)

Vector of sonic conductances inside the resistive element, with each conductance corresponding to a value in the **Opening fraction vector** parameter. The sonic conductances must increase monotonically from left to right, with greater opening fractions generally translating into greater sonic conductances. The size of the vector must be the same as that of the **Opening fraction vector**.

Critical pressure ratio vector — Critical pressure ratios corresponding to the values in the opening fraction vector

[0.3, 0.3, 0.3, 0.3, 0.3, 0.3] (default) | vector of positive unitless numbers

Vector of critical pressure ratios at which the flow first chokes, with each critical pressure ratio corresponding to a value in the **Opening fraction vector** parameter. The critical pressure ratio is the fraction of downstream to upstream pressures at which the flow velocity reaches the local speed of sound. The size of the vector must be the same as that of the **Opening fraction vector**.

Subsonic index — Exponent used to more accurately characterize mass flow in the subsonic flow regime

0.5 (default) | positive unitless scalar

Exponent used to more accurately calculate the mass flow rate in the subsonic flow regime as described in ISO 6358. This parameter is treated as a constant independent of the opening fraction specified by the control signal at port **L**.

Cv coefficient (USCS) at maximum flow — Cv coefficient corresponding to a maximally open component

0.4 (default) | positive scalar in units of ft³/min

Value of the C_v flow coefficient when the control signal specified at port **L** is 1. The cross-sectional area available for flow is then at a maximum. During simulation the flow coefficient at intermediate control signals (those valued between 0 and 1) is set by linear interpolation between this value and that of the **Cv coefficient (USCS) at leakage flow** parameter.

Cv coefficient (USCS) at leakage flow — Cv coefficient corresponding to a maximally closed component

1e-6 (default) | positive scalar in units of ft³/min

Value of the C_v flow coefficient when the control signal specified at port **L** is 0. The cross-sectional area available for flow is then at a minimum, with only a negligible leakage flow remaining between the ports. The primary purpose of this parameter is to ensure the numerical robustness of the model during simulation. Its exact value is less important than its being a very small number greater than zero.

During simulation the flow coefficient at intermediate control signals (those valued between 0 and 1) is set by linear interpolation between this value and that of the **Cv coefficient (USCS) at maximum flow** parameter.

Cv coefficient (USCS) vector – Cv coefficients corresponding to the values in the opening fraction vector

[1e-06, .08, .16, .24, .32, .4] (default) | vector of positive numbers in units of ft³/min

Vector of C_v flow coefficients expressed in US customary units of ft³/min, with each coefficient corresponding to a value in the **Opening fraction vector** parameter. The flow coefficients must increase monotonically from left to right, with greater opening fractions generally translating into greater flow coefficients. The size of the vector must be the same as that of the **Opening fraction vector**.

Kv coefficient (SI) at maximum flow – Kv coefficient corresponding to a maximally open component

0.3 (default) | positive scalar in units of m³/hr

Value of the K_v flow coefficient when the control signal specified at port **L** is 1. The cross-sectional area available for flow is then at a maximum. During simulation the flow coefficient at intermediate control signals (those valued between 0 and 1) is set by linear interpolation between this value and that of the **Kv coefficient (SI) at leakage flow** parameter.

Kv coefficient (SI) at leakage flow – Kv coefficient corresponding to a maximally closed component

1e-6 (default) | positive scalar in units of m³/hr

Value of the K_v flow coefficient when the control signal specified at port **L** is 0. The cross-sectional area available for flow is then at a minimum, with only a negligible leakage flow remaining between the ports. The primary purpose of this parameter is to ensure the numerical robustness of the model during simulation. Its exact value is less important than its being a very small number greater than zero.

During simulation the flow coefficient at intermediate control signals (those valued between 0 and 1) is set by linear interpolation between this value and that of the **Kv coefficient (SI) at maximum flow** parameter.

Kv coefficient (USCS) vector – Kv coefficients corresponding to the values in the opening fraction vector

1e-06, .06, .12, .18, .24, .3] (default) | vector of positive numbers in units of m³/hr

Vector of K_v flow coefficients expressed in SI units of m³/hr, with each coefficient corresponding to a value in the **Opening fraction vector** parameter. The flow coefficients must increase monotonically from left to right, with greater opening fractions generally translating into greater flow coefficients. The size of the vector must be the same as that of the **Opening fraction vector**.

Kv coefficient (SI) – Flow coefficient expressed in SI units

0.3 (default) | positive unitless scalar

Flow coefficient expressed in SI units of m³/hr. This parameter measures the ease with which the gas traverses the resistive element when driven by a pressure differential. See the block description for the correspondence between these parameters.

Restriction area at maximum flow — Flow area corresponding to a maximally open component

$1e-5 \text{ m}^2$ (default) | positive scalar in units of area

Value of the flow area at the point of shortest aperture when the control signal specified at port **L** is 1. The cross-sectional area available for flow is then at a maximum. During simulation the flow area at intermediate control signals (those valued between 0 and 1) is set by linear interpolation between this value and that of the **Restriction area at leakage flow** parameter.

Restriction area at leakage flow — Flow area corresponding to a maximally closed component

$1e-10 \text{ m}^2$ (default) | positive scalar in units of area

Value of the flow area at the point of shortest aperture when the control signal specified at port **L** is 0. The cross-sectional area available for flow is then at a minimum, with only a negligible leakage flow remaining between the ports. The primary purpose of this parameter is to ensure the numerical robustness of the model during simulation. Its exact value is less important than its being a very small number greater than zero.

During simulation the flow area at intermediate control signals (those valued between 0 and 1) is set by linear interpolation between this value and that of the **Restriction area at maximum flow** parameter.

Restriction area vector — Flow areas corresponding to the values in the opening fraction vector

$[1e-10, 2e-06, 4e-06, 6e-06, 8e-06, 1e-05] \text{ m}^2$ (default) | vector of positive numbers in units of area

Vector of flow areas as measured at the point of shortest aperture, with each flow area corresponding to a value in the **Opening fraction vector** parameter. The flow areas must increase monotonically from left to right, with greater opening fractions generally translating into greater flow areas. The size of the vector must be the same as that of the **Opening fraction vector**.

Cross-sectional area at ports A and B — Flow area at the gas ports

0.01 m^2 (default) | positive scalar in units of area

Area normal to the flow path at each port. The ports are assumed to be equal in size. The flow area specified here should match those of the inlets of those components to which the resistive element connects.

Laminar flow pressure ratio — Pressure ratio at which flow transitions between laminar and turbulent regimes

0.999 (default) | positive unitless scalar

Pressure ratio at which flow transitions between laminar and turbulent flow regimes. The pressure ratio is the fraction of the absolute pressure downstream of the resistive element over the absolute pressure upstream of the same component. Typical values range from 0.995 to 0.999.

Reference temperature — ISO 8778 reference temperature

293.15 K (default) | scalar in units of temperature

Temperature at standard reference atmosphere, defined as 293.15 K in ISO 8778.

Reference density — ISO 8778 reference density

1.185 (default) | positive scalar in units of mass/volume

Density at standard reference atmosphere, defined as 1.185 kg/m³ in ISO 8778.

References

[1] P. Beater, *Pneumatic Drives*, Springer-Verlag Berlin Heidelberg, 2007.

Extended Capabilities

C/C++ Code Generation

Generate C and C++ code using Simulink® Coder™.

See Also

Orifice ISO 6358 (G)

Introduced in R2018a

Orifice with Variable Area Round Holes

Hydraulic variable orifice shaped as set of round holes drilled in sleeve

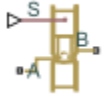

Library

Orifices

Description

The block models a variable orifice created by a cylindrical spool and a set of round holes drilled in the sleeve. All the holes are of the same diameter, evenly spread along the sleeve perimeter, and their center lines are located in the same plane. The flow rate through the orifice is proportional to the orifice opening and to the pressure differential across the orifice. The following schematic shows the cross section of an orifice with variable round holes, where

q	Flow rate
h	Orifice opening
x	Spool displacement from initial position
d_0	Orifice hole diameter

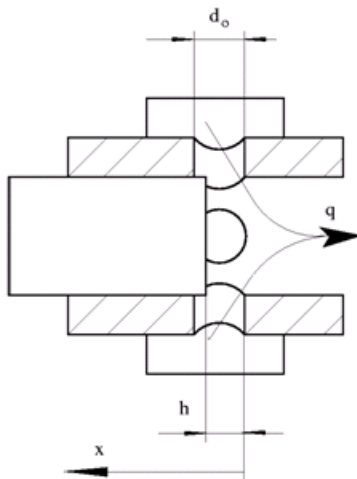

Orifice Opening Area

The aggregate opening area provided by the round holes is computed during simulation from the *orifice opening*, a measure of the instantaneous spool position:

$$h = \begin{cases} h_{\text{Min}}, & \text{if } (x_0 + \delta x) \leq h_{\text{Min}} \\ x_0 + \delta x, & \text{else} \end{cases}$$

where:

- h is the orifice opening. The subscript **Min** refers to the minimum value corresponding to a fully closed orifice. This value is calculated during simulation from block parameters.
- x is the spool displacement specified through physical signal port **S**. The subscript θ denotes the opening offset specified in the **Initial opening** block parameter.
- δ is the orifice opening orientation: +1 if positive, -1 if negative. This value is specified in the **Orifice orientation** block parameter.

The minimum orifice opening h_{Min} is calculated approximately using the expression:

$$h_{\text{Min}} \approx \frac{d_o}{2} \left[1 - \cos \left(\frac{\pi D_{h,\text{Min}}}{2 n_o d_o} \right) \right]$$

where:

- d_o is the diameter of an individual hole. This value is obtained from the **Diameter of round holes** block parameter. The holes are assumed to be identical in size.
- n_o is the number of round holes comprising the orifice. This value is obtained from the **Number of round holes** block parameter.
- $D_{h,\text{Min}}$ is the minimum value of the hydraulic diameter of the orifice as a whole. This value is calculated from the minimum opening area specified in the **Leakage area** block parameter:

$$D_{h,\text{Min}} = \frac{\pi d_o^2}{4}$$

The opening area of the orifice (the sum over the various round holes) is calculated from the conditional expression:

$$A(h) = \begin{cases} A_{\text{Leak}} & \text{for } h \leq 0 \\ \left[\frac{1}{8} n_o \cdot d_o^2 \left[2 \arccos \left(1 - \frac{2h}{d_o} \right) - \sin \left(2 \arccos \left(1 - \frac{2h}{d_o} \right) \right) \right] \right] + A_{\text{Leak}} & \text{for } 0 < h < d_o, \\ A_{\text{Max}} + A_{\text{Leak}} & \text{for } h \geq d_o \end{cases}$$

where:

- A_{Leak} is the opening area in the fully closed position, when only leakage remains. This value is obtained from the **Leakage area** block parameter.
- A_{Max} is the opening area in the fully open position, when the holes are open to full capacity. This value is calculated from the number and diameter of the holes:

$$A_{\text{Max}} = n_o \pi \frac{d_o^2}{4}$$

Orifice Flow Rate

The net flow rate through the orifice is calculated as:

$$q = C_D \cdot A(h) \sqrt{\frac{2}{\rho} \frac{\Delta p}{(\Delta p^2 + p_{Cr}^2)^{1/4}}}$$

where:

- q is the volumetric flow rate through the orifice (the sum of the flow rates through the various holes).
- C_D is the discharge coefficient of the orifice. This value is obtained from the **Flow discharge coefficient** block parameter.
- A is the aggregate opening area of the orifice (calculated as a function of the orifice opening h).
- Δp is the pressure differential from port **A** to port **B**:

$$\Delta p = p_A - p_B,$$

where p is the gauge pressure through the port indicated in the subscript.

- p_{Cr} is the calculated value of the critical pressure (from port **A** to port **B**) at which the flow is considered to shift between laminar and turbulent regimes.

Critical Pressure Differential

The calculation of the critical pressure differential varies with the setting of the **Laminar transition specification** block parameter:

- By **pressure ratio** – Obtain the critical pressure differential from the critical pressure ratio:

$$p_{Cr} = (p_{Avg} + p_{Atm})(1 - \beta),$$

where β is the critical pressure ratio, obtained from the **Laminar flow pressure ratio** block parameter, defined as the ratio of the outlet pressure to the inlet pressure at the transition point between laminar and turbulent regimes. The subscript **Atm** denotes the atmospheric value (0.101325 MPa at standard reference conditions) and the subscript **Avg** the average of the gauge pressures at the ports:

$$p_{Avg} = \frac{p_A + p_B}{2},$$

- By **Reynolds number** – Obtain the critical pressure differential from the critical Reynolds number:

$$p_{Cr} = \frac{\rho}{2} \left(\frac{Re_{Cr} \cdot \nu}{C_D \cdot D_H} \right)^2,$$

where Re_{Cr} is the critical Reynolds number, at which the flow can be said to transition between laminar and turbulent regimes, ν is the average of the kinematic viscosities at the ports, and D_h is the hydraulic diameter of the orifice:

$$D_h = \begin{cases} D_{h,Min}, & \text{if } h \leq h_{Min} \\ d_o + D_{h,Min}, & \text{if } h > d_o \\ \frac{4A}{P}, & \text{else} \end{cases},$$

with P as the sum of the perimeters of the holes:

$$P = n_o d_o \left[2a \cos \left(1 - \frac{2h}{d_o} \right) + 2a \sin \left(\cos \left[1 - \frac{2h}{d_o} \right] \right) \right]$$

Basic Assumptions and Limitations

- Fluid inertia is ignored.

Parameters

Diameter of round holes

Diameter of the orifice holes. The default value is 5e-3 m.

Number of round holes

Number of holes. The default value is 6.

Flow discharge coefficient

Semi-empirical parameter for orifice capacity characterization. Its value depends on the geometrical properties of the orifice, and usually is provided in textbooks or manufacturer data sheets. The default value is 0.6.

Initial opening

Orifice initial opening. The parameter can be positive (underlapped orifice), negative (overlapped orifice), or equal to zero for zero lap configuration. The value of initial opening does not depend on the orifice orientation. The default value is 0.

Orifice orientation

The parameter is introduced to specify the effect of the orifice control member motion on the valve opening. The parameter can be set to one of two options: `Opens in positive direction` or `Opens in negative direction`. The value `Opens in positive direction` specifies an orifice whose control member opens the valve when it is shifted in the globally assigned positive direction. The parameter is extremely useful for building a multi-orifice valve with all the orifices being controlled by the same spool. The default value is `Opens in positive direction`.

Laminar transition specification

Select how the block transitions between the laminar and turbulent regimes:

- `Pressure ratio` — The transition from laminar to turbulent regime is smooth and depends on the value of the **Laminar flow pressure ratio** parameter. This method provides better simulation robustness.
- `Reynolds number` — The transition from laminar to turbulent regime is assumed to take place when the Reynolds number reaches the value specified by the **Critical Reynolds number** parameter.

Laminar flow pressure ratio

Pressure ratio at which the flow transitions between laminar and turbulent regimes. The default value is 0.999. This parameter is visible only if the **Laminar transition specification** parameter is set to `Pressure ratio`.

Critical Reynolds number

The maximum Reynolds number for laminar flow. The value of the parameter depends on the orifice geometrical profile. You can find recommendations on the parameter value in hydraulics

textbooks. The default value is 10. This parameter is visible only if the **Laminar transition specification** parameter is set to Reynolds number.

Leakage area

The total area of possible leaks in the completely closed valve. The main purpose of the parameter is to maintain numerical integrity of the circuit by preventing a portion of the system from getting isolated after the valve is completely closed. The parameter value must be greater than 0. The default value is $1e-15 \text{ m}^2$.

Restricted Parameters

When your model is in Restricted editing mode, you cannot modify the following parameter:

- **Orifice orientation**

All other block parameters are available for modification.

Global Parameters

Parameters determined by the type of working fluid:

- **Fluid density**
- **Fluid kinematic viscosity**

Use the Hydraulic Fluid block or the Custom Hydraulic Fluid block to specify the fluid properties.

Ports

The block has the following ports:

A

Hydraulic conserving port associated with the orifice inlet.

B

Hydraulic conserving port associated with the orifice outlet.

S

Physical signal port to control spool displacement.

The flow rate is positive if fluid flows from port A to port B. Positive signal at the physical signal port S opens or closes the orifice depending on the value of the parameter **Orifice orientation**.

Extended Capabilities

C/C++ Code Generation

Generate C and C++ code using Simulink® Coder™.

See Also

Annular Orifice | Constant Area Hydraulic Orifice | Fixed Orifice | Orifice with Variable Area Slot | Variable Area Hydraulic Orifice | Variable Orifice

Topics

“Upgrading Simscape Fluids Models Containing Hydraulics (Isothermal) Blocks”

Introduced in R2006a

Orifice with Variable Area Slot

Hydraulic variable orifice shaped as rectangular slot

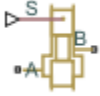

Library

Orifices

Description

The block models a variable orifice created by a cylindrical sharp-edged spool and a rectangular slot in a sleeve. The flow rate through the orifice is proportional to the orifice opening and to the pressure differential across the orifice. The flow rate is determined according to the following equations:

$$q = C_D \cdot A(h) \sqrt{\frac{2}{\rho} \frac{\Delta p}{(\Delta p^2 + p_{Cr}^2)^{1/4}}}$$

$$\Delta p = p_A - p_B,$$

$$h = x_0 + x \cdot or$$

$$A(h) = \begin{cases} A_{leak} & \text{if } b \cdot h < A_{leak} \\ b \cdot h & \text{otherwise} \end{cases}$$

where

q	Flow rate
p	Pressure differential
p_A, p_B	Gauge pressures at the block terminals
C_D	Flow discharge coefficient
$A(h)$	Instantaneous orifice passage area
b	Width of the orifice slot
x_0	Initial opening
x	Spool displacement from initial position
h	Orifice opening
or	Orifice orientation indicator. The variable assumes +1 value if a spool displacement in the globally assigned positive direction opens the orifice, and -1 if positive motion decreases the opening.
ρ	Fluid density

A_{leak}	Closed orifice leakage area
p_{cr}	Minimum pressure for turbulent flow

The minimum pressure for turbulent flow, p_{cr} , is calculated according to the laminar transition specification method:

- By pressure ratio — The transition from laminar to turbulent regime is defined by the following equations:

$$p_{\text{cr}} = (p_{\text{avg}} + p_{\text{atm}})(1 - B_{\text{lam}})$$

$$p_{\text{avg}} = (p_A + p_B)/2$$

where

p_{avg}	Average pressure between the block terminals
p_{atm}	Atmospheric pressure, 101325 Pa
B_{lam}	Pressure ratio at the transition between laminar and turbulent regimes (Laminar flow pressure ratio parameter value)

- By Reynolds number — The transition from laminar to turbulent regime is defined by the following equations:

$$p_{\text{cr}} = \frac{\rho}{2} \left(\frac{Re_{\text{cr}} \cdot \nu}{C_D \cdot D_H} \right)^2$$

$$D_H = \sqrt{\frac{4A}{\pi}}$$

where

D_H	Instantaneous orifice hydraulic diameter
ν	Fluid kinematic viscosity
Re_{cr}	Critical Reynolds number (Critical Reynolds number parameter value)

The block positive direction is from port A to port B. This means that the flow rate is positive if it flows from A to B and the pressure differential is determined as $\Delta p = p_A - p_B$. Positive signal at the physical signal port S opens or closes the orifice depending on the value of the parameter **Orifice orientation**.

Basic Assumptions and Limitations

- Fluid inertia is not taken into account.

Parameters

Orifice width

The width of the rectangular slot. The default value is 1e-2 m.

Flow discharge coefficient

Semi-empirical parameter for orifice capacity characterization. Its value depends on the geometrical properties of the orifice, and usually is provided in textbooks or manufacturer data sheets. The default value is 0.7.

Initial opening

Orifice initial opening. The parameter can be positive (underlapped orifice), negative (overlapped orifice), or equal to zero for zero lap configuration. The value of initial opening does not depend on the orifice orientation. The default value is 0.

Orifice orientation

The parameter is introduced to specify the effect of the orifice control member motion on the valve opening. The parameter can be set to one of two options: `Opens in positive direction` or `Opens in negative direction`. The value `Opens in positive direction` specifies an orifice whose control member opens the valve when it is shifted in the globally assigned positive direction. The parameter is extremely useful for building a multi-orifice valve with all the orifices being controlled by the same spool. The default value is `Opens in positive direction`.

Laminar transition specification

Select how the block transitions between the laminar and turbulent regimes:

- `Pressure ratio` — The transition from laminar to turbulent regime is smooth and depends on the value of the **Laminar flow pressure ratio** parameter. This method provides better simulation robustness.
- `Reynolds number` — The transition from laminar to turbulent regime is assumed to take place when the Reynolds number reaches the value specified by the **Critical Reynolds number** parameter.

Laminar flow pressure ratio

Pressure ratio at which the flow transitions between laminar and turbulent regimes. The default value is 0.999. This parameter is visible only if the **Laminar transition specification** parameter is set to `Pressure ratio`.

Critical Reynolds number

The maximum Reynolds number for laminar flow. The value of the parameter depends on the orifice geometrical profile. You can find recommendations on the parameter value in hydraulics textbooks. The default value is 12. This parameter is visible only if the **Laminar transition specification** parameter is set to `Reynolds number`.

Leakage area

The total area of possible leaks in the completely closed valve. The main purpose of the parameter is to maintain numerical integrity of the circuit by preventing a portion of the system from getting isolated after the valve is completely closed. The parameter value must be greater than 0. The default value is $1e-12 \text{ m}^2$.

Restricted Parameters

When your model is in Restricted editing mode, you cannot modify the following parameter:

- **Orifice orientation**

All other block parameters are available for modification.

Global Parameters

Parameters determined by the type of working fluid:

- **Fluid density**
- **Fluid kinematic viscosity**

Use the Hydraulic Fluid block or the Custom Hydraulic Fluid block to specify the fluid properties.

Ports

The block has the following ports:

A

Hydraulic conserving port associated with the orifice inlet.

B

Hydraulic conserving port associated with the orifice outlet.

S

Physical signal port to control spool displacement.

The flow rate is positive if fluid flows from port A to port B. Positive signal at the physical signal port S opens or closes the orifice depending on the value of the parameter **Orifice orientation**.

Extended Capabilities

C/C++ Code Generation

Generate C and C++ code using Simulink® Coder™.

See Also

Annular Orifice | Constant Area Hydraulic Orifice | Fixed Orifice | Orifice with Variable Area Round Holes | Variable Area Hydraulic Orifice | Variable Orifice

Topics

“Upgrading Simscape Fluids Models Containing Hydraulics (Isothermal) Blocks”

Introduced in R2006a

Orifice (2P)

Constant- or variable-area orifice in a two-phase fluid network

Library: Simscape / Fluids / Two-Phase Fluid / Valves & Orifices



Description

The Orifice (2P) block models pressure loss due to a constant or variable area orifice in a two-phase fluid network. The orifice can be constant or variable. When **Orifice type** is set to **Variable**, the physical signal at port **S** sets the position of the control member, which opens and closes the orifice.

Fluid properties inside the valve are calculated from inlet conditions. There is no heat exchange between the fluid and the environment, and therefore phase change inside the orifice only occurs due to a pressure drop or a propagated phase change from another part of the model.

A number of block parameters are based on nominal operating conditions, which correspond to the orifice rated performance, such as a specification on a manufacturer datasheet.

Constant Area

When you set **Orifice type** to **Constant**, the orifice has a constant area. The mass flow rate through the orifice is:

$$\dot{m}_A = \dot{m}_{nom} \left[\sqrt{\frac{v_{nom}}{2\Delta p_{nom}}} \right] \sqrt{\frac{2}{v_{in}}} \frac{\Delta p}{(\Delta p^2 + \Delta p_{lam}^2)^{0.25}},$$

where:

- Δp is the pressure drop over the orifice, $p_A - p_B$.
- Δp_{lam} is the pressure transition threshold between laminar and turbulent flow, which is calculated from the **Laminar flow pressure ratio**, B_{lam} :

$$\Delta p_{lam} = \frac{(p_A + p_B)}{2} (1 - B_{lam}).$$

- \dot{m}_{nom} is the **Nominal mass flow rate**.
- Δp_{nom} is the **Nominal pressure drop rate**.
- v_{nom} is the nominal inlet specific volume. This value is determined from the fluid properties tabulated data based on the **Nominal inlet condition specification** parameter.
- v_{in} is the inlet specific volume.

Variable Area

When you set **Orifice type** to **Variable**, the block is configured for a variable opening, which is set by the control member position at **S**. The block calculates the mass flow rate through the variable-area orifice as:

$$\dot{m}_A = \lambda \dot{m}_{nom} \left[\sqrt{\frac{v_{nom}}{2\Delta p_{nom}}} \right] \sqrt{\frac{2}{v_{in}}} \frac{\Delta p}{(\Delta p^2 + \Delta p_{lam}^2)^{0.25}},$$

where λ is the orifice opening fraction.

Control Member Displacement

The orifice opening, which is expressed as a fraction of the total orifice open area, is determined by the input signal at **S**, the **Control member travel between closed and open orifice** parameter, ΔS , and a leakage value that improves numerical stability when the orifice is closed:

$$\lambda = \varepsilon(1 - f_{leak})\frac{(S - S_{min})}{\Delta S} + f_{leak},$$

where:

- ε is the **Opening orientation**. This value is +1 when the setting is Positive control member displacement opens orifice and -1 when the setting is Negative control member displacement opens orifice.
- f_{leak} is the **Closed orifice leakage as a fraction of nominal flow**.
- S_{min} is the **Control member position at closed orifice**.

Fluid Specific Volume Dynamics

When the fluid at the orifice inlet is a liquid-vapor mixture, the block calculates the specific volume as:

$$v_{in} = (1 - x_{dyn})v_{liq} + x_{dyn}v_{vap},$$

where:

- x_{dyn} is the inlet vapor quality. The block applies a first-order lag to the inlet vapor quality of the mixture.
- v_{liq} is the liquid specific volume of the fluid.
- v_{vap} is the vapor specific volume of the fluid.

If the inlet fluid is liquid or vapor, v_{in} is the respective liquid or vapor specific volume.

Vapor Quality Lag

If the inlet vapor quality is a liquid-vapor mixture, the block applies a first-order time lag:

$$\frac{dx_{dyn}}{dt} = \frac{x_{in} - x_{dyn}}{\tau},$$

where:

- x_{dyn} is the dynamic vapor quality.
- x_{in} is the current inlet vapor quality.
- τ is the **Inlet phase change time constant**.

If the inlet fluid is a subcooled liquid or superheated vapor, x_{dyn} is equal to x_{in} .

Mass Balance

Mass is conserved in the orifice:

$$\dot{m}_A + \dot{m}_B = 0,$$

where:

- \dot{m}_A is the mass flow rate at port **A**.
- \dot{m}_B is the mass flow rate at port **B**.

Energy Balance

Energy is conserved in the orifice:

$$\Phi_A + \Phi_B = 0,$$

where:

- Φ_A is the energy flow at port **A**.
- Φ_B is the energy flow at port **B**.

Assumptions and Limitations

- The block does not model pressure recovery downstream of the valve.
- There is no heat exchange between the valve and the environment.
- The block does not model choked flow.

Ports

Conserving

A – Fluid port

two-phase fluid

Fluid entry or exit port.

B – Fluid port

two-phase fluid

Fluid entry or exit port.

Input

S – Control member position

physical signal

Control member position that sets the orifice opening.

Dependencies

To enable this port, set **Orifice type** to **Variable**.

Parameters

Orifice type – Constant or variable orifice

Variable (default) | Constant

Type of orifice. When set to **Variable**, the orifice area varies according to the input signal received at port **S**.

Nominal mass flow rate — Rated mass flow rate

0.1 kg/s (default) | positive scalar

Typical, rated, or design mass flow rate through a constant orifice.

Dependencies

To enable this parameter, set **Orifice type** to Constant.

Nominal pressure drop — Rated pressure drop

0.001 MPa (default) | positive scalar

Typical, rated, or design pressure drop through a constant orifice.

Dependencies

To enable this parameter, set **Orifice type** to Constant.

Control member position at closed orifice — Control member offset

0 m (default) | positive scalar

Control member offset, or the value at **S** when the orifice is fully closed.

Dependencies

To enable this parameter, set **Orifice type** to Variable.

Control member travel between closed and open orifice — Control member stroke

5e-3 m (default) | positive scalar

Distance the control member travels between a closed and open orifice. When you set **Opening orientation** to Positive control member displacement opens orifice, the orifice is fully open at the sum of the **Control member position at closed orifice** and **Control member travel between closed and open orifice** parameters. When you set **Opening orientation** to Negative control member displacement opens orifice, the orifice is fully open at the difference between the **Control member position at closed orifice** and **Control member travel between closed and open orifice** parameters.

Dependencies

To enable this parameter, set **Orifice type** to Variable.

Opening orientation — Direction of displacement that opens the orifice

Positive control member displacement opens orifice (default) | Negative control member displacement opens orifice

Direction of member displacement that opens a variable orifice. A positive orientation means that an increase in the signal at **S** opens the orifice. A negative orientation means that a decrease in the signal at **S** opens the orifice.

Dependencies

To enable this parameter, set **Orifice type** to Variable.

Nominal mass flow rate at maximum opening — Rated mass flow rate

0.1 kg/s (default) | positive scalar

Mass flow rate through a fully open orifice under typical, design, or rated conditions.

Dependencies

To enable this parameter, set **Orifice type** to Variable.

Nominal pressure drop at maximum opening — Rated pressure drop

0.001 MPa (default) | positive scalar

Pressure drop over a fully open orifice under typical, design, or rated conditions.

Dependencies

To enable this parameter, set **Orifice type** to Variable.

Nominal inlet condition specification — Method of determining inlet fluid state

Temperature (default) | Vapor quality | Vapor void fraction | Specific enthalpy | Specific internal energy

Method of determining inlet fluid state. The orifice nominal inlet specific volume is determined from the fluid properties tabulated data based on the **Nominal inlet pressure** and the setting of the **Nominal inlet condition specification** parameters.

Nominal inlet pressure — Inlet fluid pressure

0.101325 MPa (default) | positive scalar

Inlet pressure in nominal conditions. The inlet specific volume is determined from the fluid properties tabulated data based on the **Nominal inlet pressure** and the setting of the **Nominal inlet condition specification** parameters.

Nominal inlet temperature — Fluid temperature

293.15 K (default) | positive scalar

Inlet fluid temperature in nominal operating conditions.

Dependencies

To enable this parameter, set **Nominal inlet condition specification** to Temperature.

Nominal inlet vapor quality — Inlet vapor quality mass fraction

0.5 (default) | positive scalar in the range [0,1]

Inlet mixture vapor quality by mass fraction in nominal operating conditions. A value of 0 means that the inlet fluid is subcooled liquid. A value of 1 means that the inlet fluid is superheated vapor.

Dependencies

To enable this parameter, set **Nominal inlet condition specification** to Vapor quality.

Nominal inlet vapor void fraction — Inlet volume fraction

0.5 (default) | positive scalar in the range [0,1]

Inlet mixture volume fraction in nominal operating conditions. A value of 0 means that the inlet fluid is subcooled liquid. A value of 1 means that the inlet fluid is superheated vapor.

Dependencies

To enable this parameter, set **Nominal inlet condition specification** to Vapor void fraction.

Nominal inlet specific enthalpy – Inlet fluid specific enthalpy

1500 kJ/kg (default) | positive scalar

Inlet specific enthalpy in nominal operating conditions.

Dependencies

To enable this parameter, set **Nominal inlet condition specification** to Specific enthalpy.

Nominal inlet specific internal energy – Inlet specific internal energy

1500 kJ/kg (default) | positive scalar

Inlet specific internal energy in nominal operating conditions.

Dependencies

To enable this parameter, set **Nominal inlet condition specification** to Specific internal energy.

Cross-sectional area at ports A and B – Valve port areas0.01 m² (default) | positive scalar

Area of the orifice ports **A** and **B**.

Closed orifice leakage as a fraction of nominal flow – Fractional flow when orifice is closed

1e-6 (default) | positive scalar

Fractional flow rate through the orifice when it is fully closed. This parameter contributes to numerical stability by maintaining continuity in the fluid network.

Smoothing factor – Numerical smoothing factor

0.01 (default) | positive scalar in the range [0,1]

Continuous smoothing factor that introduces a layer of gradual change to the flow response when the orifice is in near-open or near-closed positions. Set this parameter to a nonzero value less than one to increase the stability of your simulation in these regions.

Laminar flow pressure ratio – Laminar-turbulent transition pressure ratio

0.999 (default) | positive scalar

Ratio of the orifice outlet pressure to orifice inlet pressure at which the fluid transitions between the laminar and turbulent regimes. The pressure loss corresponds to the mass flow rate linearly in laminar flows and quadratically in turbulent flows.

Inlet phase change time constant – Lag for mixture specific volume

0.1 s (default) | positive scalar

Time lag for liquid-vapor mixtures in computing the fluid specific volume. This parameter does not influence the specific volume when the inlet fluid is a fully supercooled liquid or fully superheated vapor.

See Also

Check Valve (2P) | Pressure-Reducing Valve (2P) | Pressure Relief Valve (2P) | Thermostatic Expansion Valve (2P)

Introduced in R2021a

P-H Diagram (2P)

Thermodynamic scope for two-phase fluid networks

Library: Simscape / Fluids / Two-Phase Fluid / Utilities

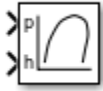

Description

The P-H Diagram (2P) block plots pressure with respect to the specific enthalpy of a thermodynamic, two-phase fluid in a typical p-h diagram. A p-h diagram indicates the fluid state at key points during a thermodynamic cycle.

The plot units are MPa for pressure and kJ/kg for specific enthalpy.

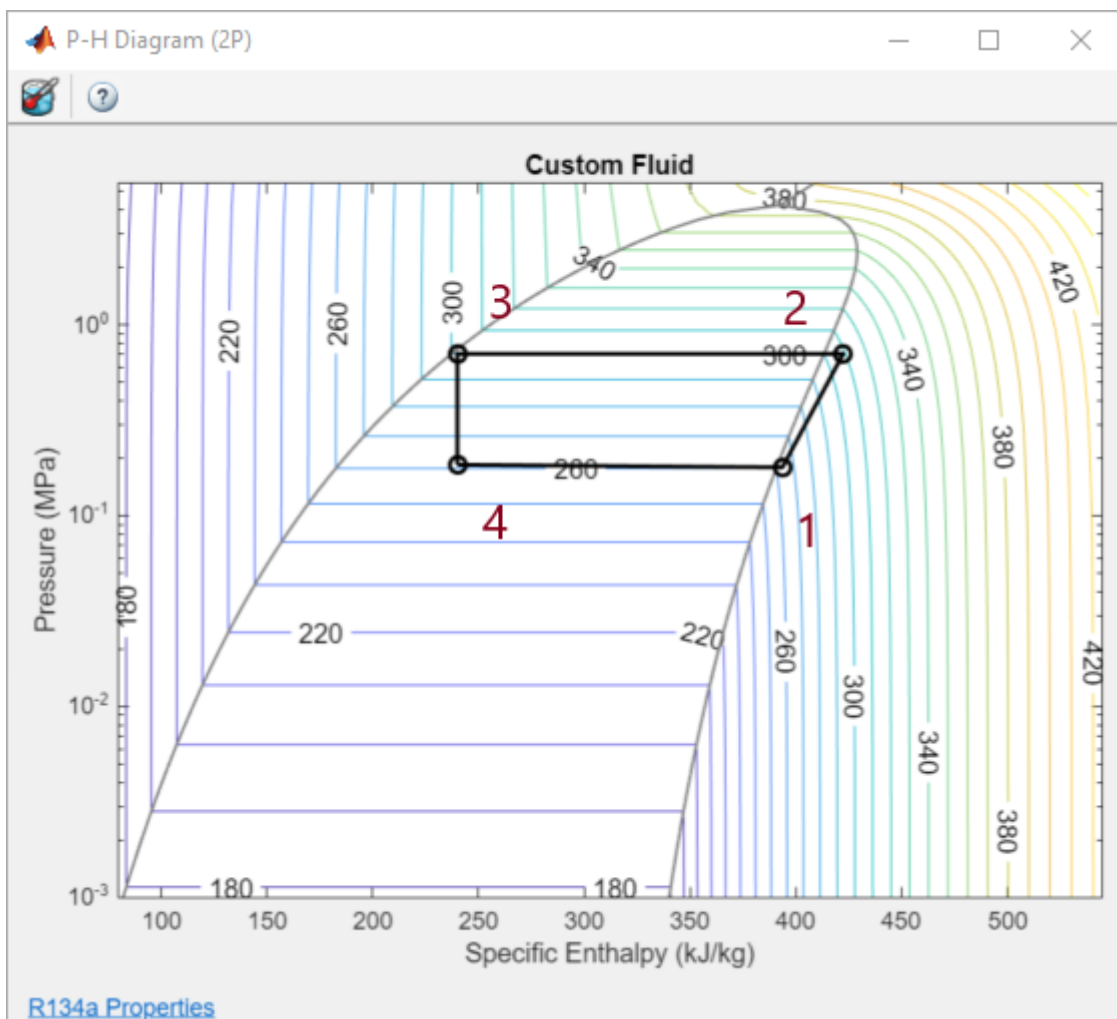

Each numbered point on the diagram indicates the fluid state after a dynamic process in the refrigeration cycle:

- 1 Cool vapor at low pressure
- 2 Hot vapor at high pressure
- 3 Hot liquid at high pressure
- 4 Mixed vapor and liquid at low pressure

To use the P-H Diagram (2P) block:

- 1 Place a Thermodynamic Properties Sensor (2P) and a Pressure & Internal Energy Sensor (2P) block at each location you want to monitor.

Note The Pressure & Internal Energy Sensor (2P) block measures a differential pressure. Connect port **A** to the monitor point and port **B** to an Absolute Reference (2P) block.

- 2 Convert the Simscape physical signals to Simulink signals with a PS-Simulink Converter block.
- 3 Combine the converted pressure signals into a Mux block. Connect the output signal to the P-H Diagram (2P) **p** port.
- 4 Combine the converted specific enthalpy signals into a Mux block and connect this output to the **h** port.
- 5 Before running the simulation, double-click the P-H Diagram (2P) block, then click the Select



fluid properties button  to set the network fluid properties.

If you do not select the fluid properties, the block will use the default two-phase network fluid, which is water.

You can monitor the progress in the cycle by opening the block before starting the simulation.

Viewing a p-h Plot

If the process occurs too quickly to see cycle development, you can use simulation pacing to slow the visualization. In Simulink, click **Run > Simulation Pacing** to slow down the simulation time.

You can pause, stop, or step through a simulation, to pause at that time step. To save the current iteration of the plot, point to the plot area. From the icons that appear in the top-right corner of the plot, click the Export icon  and select **Save As**  to save the plot.

Ports

Input

p — Pressure, MPa

vector

Vector of pressures. The vector must have same number of elements as the enthalpy signal at port **h**

h — Specific enthalpy, kJ/kg

vector

Vector of specific enthalpies. The vector must have same number of elements as the pressure signal at port **p**.

See Also

Thermostatic Expansion Valve (2P)

Introduced in R2021a

Partially Filled Pipe (IL)

Pipe with variable liquid volume in an isothermal liquid system

Library: Simscape / Fluids / Isothermal Liquid / Pipes & Fittings

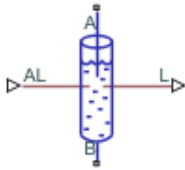

Description

The Partially Filled Pipe (IL) block models a pipe with the capacity for varying internal liquid levels. The pipe may also become completely dry during simulation.

In addition to liquid connections at ports **A** and **B**, port **AL** receives the inlet liquid level from connected blocks as a physical signal. If the value at **AL** is greater than zero, **A** is submerged. If the value at **AL** is less than or equal to zero, the port is exposed. The pipe liquid level is transmitted as a physical signal to connecting blocks at port **L**.

Port **A** is always higher than port **B**. If port **A** becomes exposed, the pipe can be filled through port **B**. When fluid enters the pipe through port **B**, the mass flow rate through port **A** is 0 until the pipe is fully filled, at which point $\dot{m}_A = \dot{m}_B$.

When to Use the Partially Filled Pipe (IL) Block

This block can be used in conjunction with the Tank (IL) block when fluid levels are expected to fall below the tank inlet. Multiple Partially Filled Pipe (IL) blocks can also be connected in series or parallel. However, because a partially filled pipe can only be filled at port **B**, if port **A** of one block in a parallel configuration becomes exposed, it may not be possible to refill this pipe if its connection at port **B** cannot refill the pipe.

Pressure Loss Over the Pipe

The pressure differential over the pipe, $p_A - p_B$, comprises losses due to wall friction and hydrostatic pressure differences between the liquid surface height and the liquid height at port **A**:

$$p_A - p_B = \Delta p_{loss} + \Delta p_{elev}.$$

Friction losses depend on the fluid regime in the pipe. If the flow is laminar, the friction losses are:

$$\Delta p_{loss} = \frac{-\dot{m}_B \nu f_s \hat{L}}{2D_h^2 A^2},$$

where:

- ν is the fluid kinematic viscosity.
- f_s is the **Laminar friction constant for Darcy friction factor**.

- \widehat{L} is the sum of the pipe length and its **Aggregate equivalent length of local resistances**, in proportion to the pipe fill level: $\widehat{L} = (L + L_{add})\frac{l}{l_{\max}}$.
- D_h is the pipe hydraulic diameter. If the pipe cross-section is not circular, the hydraulic diameter is the equivalent circular diameter.

If the flow is turbulent, the friction losses are:

$$\Delta p_{\text{loss}} = \frac{-\dot{m}_B |\dot{m}_B| f \widehat{L}}{2\rho D_h^2 A^2}.$$

f is the Darcy friction factor for turbulent flows, which is determined by the empirical Haaland correlation:

$$f = \left\{ -1.8 \log_{10} \left[\frac{6.9}{\text{Re}} + \left(\frac{\varepsilon}{3.7 D_h} \right)^{1.11} \right] \right\}^{-2},$$

where ε is the **Internal surface absolute roughness**. The Reynolds number is based on the mass flow rate at port **B** and the pipe hydraulic diameter.

The hydrostatic pressure difference is $\Delta p_{\text{elev}} = \rho g l$.

Mass Flow Rate

The flow in the pipe is dictated by the internal fluid level and the conditions at port **B**. The pipe can be filled or drained at **B** if the pipe is partially empty. If the pipe is fully filled, $\dot{m}_A = \dot{m}_B$, and mass is conserved:

$$\dot{m}_A + \dot{m}_B = 0.$$

The mass of fluid in the pipe is determined by the relative fill level of the pipe:

$$M = \rho A L \frac{l}{l_{\max}}.$$

Assumptions and Limitations

This block does not account for dynamic compressibility or fluid inertia, and does not model the dynamics of air (or second liquid) in the pipe.

Ports

Conserving

A – Liquid port

isothermal liquid

Fluid entry or exit to the pipe. Port **A** is always higher than port **B**. When port **A** is submerged, $\dot{m}_A = \dot{m}_B$. When port **A** is exposed, $\dot{m}_A = 0$.

B – Liquid port

isothermal liquid

Fluid entry or exit to the pipe. Port **A** is always higher than port **B**. When port **A** is submerged, $\dot{m}_A = \dot{m}_B$. When port **A** is exposed, any flow into or out of port **B** changes the liquid level in the pipe. A dry or partially dry pipe can only be filled through port **B**.

Input

AL — Relative liquid level of connected block, m

physical signal

Relative liquid level of the connected block in m, specified as a physical signal. If the signal at **AL** is positive, the pipe end is submerged. Otherwise the port is exposed.

Output

L — Pipe liquid level, m

physical signal

Liquid level in the pipe in m, returned as a physical signal..

Parameters

Geometry

Pipe length — Pipe length

5 m (default) | positive scalar

Pipe length.

Cross-sectional area — Pipe cross-sectional area

0.01 m² (default) | positive scalar

Cross-sectional area of the pipe.

Hydraulic diameter — Hydraulic diameter

0.1128 m (default) | positive scalar

Hydraulic diameter used in calculations of the pipe Reynolds number. For non-circular pipes, the hydraulic diameter is the effective diameter of the fluid in the pipe. For circular pipes, the hydraulic diameter and pipe diameter are the same.

Elevation drop from port A to port B — Vertical distance between A and B

5 m (default) | positive scalar

Vertical change in elevation of the pipe. Port **A** is always higher than port **B**.

Initial liquid level — Starting liquid level

5 m (default) | positive scalar

Liquid level in the pipe at the beginning of the simulation.

Liquid level below zero — Whether to notify if no liquid is in pipe

Error (default) | None | Warning

Whether to notify if no liquid is in the pipe. Set this parameter to **Warning** if you would like to receive a warning when this occurs during simulation. Set the parameter to **Error** if you would like the simulation to stop when this occurs.

Gravitational acceleration – Acceleration of gravity

9.81 m/s² (default) | positive scalar

Acceleration of gravity constant.

Friction

Aggregate equivalent length of local resistances – Contribution of pipe geometry to hydraulic losses

1 m (default) | positive scalar

Length of pipe that would produce the equivalent hydraulic losses as would a pipe with bends, area changes, or other non-uniform attributes.

Internal surface absolute roughness – Pipe wall roughness

15e-6 m (default) | positive scalar

Pipe wall absolute roughness. This parameter is used to determine the Darcy friction factor, which contributes to pressure loss in the pipe.

Laminar flow upper Reynolds number limit – Laminar flow upper threshold

2000 (default) | positive scalar

Upper Reynolds number limit to laminar flow. Beyond this number, the fluid regime is transitional and approaches the turbulent regime and becomes fully turbulent at the **Turbulent flow lower Reynolds number limit**.

Turbulent flow lower Reynolds number limit – Turbulent flow lower threshold

4000 (default) | positive scalar

Lower Reynolds number limit for turbulent flow. Below this number, the flow regime is transitional and approaches laminar flow and becomes fully laminar at the **Laminar flow upper Reynolds number limit**.

Laminar friction constant for Darcy friction factor – Pipe friction constant for laminar flows

64 (default) | positive scalar

Pipe friction constant for laminar flows. The laminar Darcy friction factor captures the contribution of wall friction in pressure loss calculations.

See Also

Pipe (IL) | Tank (IL)

Introduced in R2020a

Partially Filled Vertical Pipe LP

Partially filled vertical pipe connecting two tanks



Library

Low-Pressure Blocks

Description

The Partially Filled Vertical Pipe LP block models a vertical pipe connecting two tanks. The block takes into account the possibility that the top tank gets emptied, and therefore the top port of the pipe can be exposed. The fluid level in the pipe then settles at some intermediate position, depending on pressures at both ports.

The following schematic diagram shows two tanks connected by a partially filled vertical pipe, where:

- h_A and h_B are the elevations of ports A and B, respectively
- h_P is the fluid level in the pipe
- L is the length of the pipe

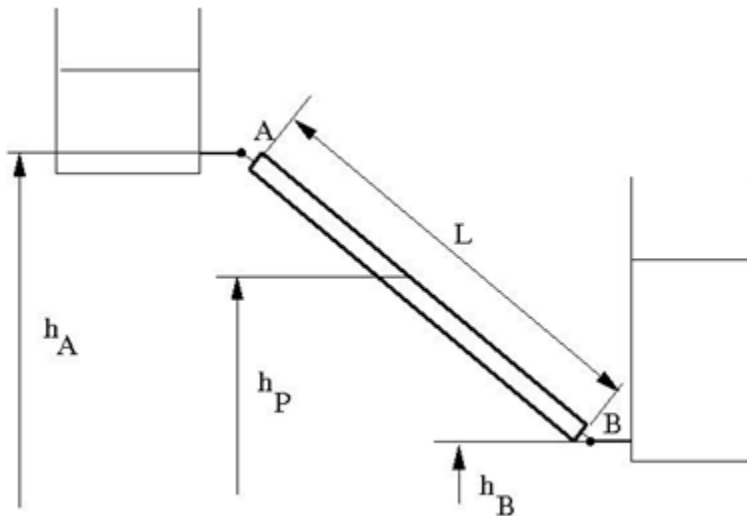

The tank is assumed to be empty when fluid volume becomes less than a specified value. If the upstream tank is emptied, the flow rate through port A is assumed to be 0, and the tank pressurization pressure propagates through port A to the pipe. When pressure increases at the bottom port B, the fluid flows upstream. After the pipe is completely filled, the fluid can start filling the top tank.

You must connect port A to a component that provides data on fluid volume (such as the Reservoir block or any of the tank blocks). Port A elevation must be greater than port B elevation.

You can connect port B to any hydraulic component, with one restriction: the component must keep the port submerged at all times.

The pipe hydraulic resistance is proportional to the length of fluid in the pipe (wet length). The shorter the wet length, the lower the resistance. To avoid zero resistance as wet length approaches 0, the volume of fluid in the pipe is limited to the same minimum value as the tank. After the minimum volume is reached, the flow rate through port B is assumed to be 0.

It is a good practice to connect port B either to another tank or to a pressure source. When you connect it to a pressure source, it is good practice to insert some hydraulic resistance (fixed orifice, valve, and so on) between the pipe and the source, to avoid zero resistance.

The block models pipes with circular and noncircular cross sections. The block accounts for friction losses, variable fluid level in the pipe, and resulting variable heads at the ports. The block is based on the assumption of steady-state fluid momentum conditions. For additional information, see “Basic Assumptions and Limitations” on page 1-1123. To account for local resistances (such as bends, fittings, inlet and outlet losses, and so on), convert the resistances into their equivalent lengths, sum up all the resistances to obtain their aggregate length, and then add this length to the pipe geometrical length. The ratio between the added and the current wet length of the pipe is maintained constant as the pipe is emptied or filled with fluid.

Flow rates through the pipe ports are computed individually because they are different when the top port is exposed. The flow rates are proportional to the flow-regime-dependent friction factor and the pressure differential. The friction factor in turbulent regime is determined with the Haaland approximation [1 on page 1-1125]:

$$f = \frac{1}{\left(-1.8 \log_{10} \left(\frac{6.9}{Re} + \left(\frac{k/D_H}{3.7} \right)^{1.11} \right)\right)^2}$$

$$Re = \frac{q \cdot D_H}{A \cdot \nu}$$

where

f	Friction factor
k	Height of the roughness on the pipe internal surface
Re	Reynolds number
q	Flow rate
D_H	Pipe hydraulic diameter
A	Pipe cross-sectional area
ν	Fluid kinematic viscosity

At laminar regime, the friction factor is determined as

$$f = \frac{S}{Re}$$

where s is the geometrical shape factor, or Poiseuille number [1 on page 1-1125], defined as a function of the Fanning factor for various noncircular shapes: rectangle, concentric annulus, ellipse, and circular sector.

The friction factor during the transition from laminar to turbulent regimes is determined with the linear interpolation between extreme points of the regimes. As a result of these assumptions, the pipe is simulated according to the following equations:

$$q_A = \begin{cases} 0 & \text{for } p > = 0, V < V_{\min} \\ A \sqrt{\frac{1}{f}} \frac{D_H}{L_{ef}} \sqrt{\frac{2}{\rho}} \cdot p & \text{for } p > = 0, V > = V_{\min}, Re > = Re_{cr} \\ 2 \cdot A \cdot \frac{D_H^2}{s \cdot \nu \cdot \rho \cdot L_{ef}} \cdot p & \text{for } p > = 0, V > = V_{\min}, Re < Re_{cr} \\ 0 & \text{for } p < 0, L_F < = L \\ 2 \cdot A \cdot \frac{D_H^2}{s \cdot \nu \cdot \rho \cdot L_{ef}} \cdot p & \text{for } p < 0, L_F > L, Re < Re_{cr} \\ A \sqrt{\frac{1}{f}} \frac{D_H}{L_{ef}} \sqrt{\frac{2}{\rho}} \cdot |p| & \text{for } p < 0, L_F > L, Re > = Re_{cr} \end{cases}$$

$$q_B = \begin{cases} 0 & \text{for } p > = 0, V_F < V_{\min} \\ A \sqrt{\frac{1}{f}} \frac{D_H}{L_{ef}} \sqrt{\frac{2}{\rho}} \cdot |p| \cdot \text{sign}(p) & \text{for } p > = 0, V_F > = V_{\min}, Re > = Re_{cr} \\ 2 \cdot A \cdot \frac{D_H^2}{s \cdot \nu \cdot \rho \cdot L_{ef}} \cdot p & \text{for } p > = 0, V_F > = V_{\min}, Re < Re_{cr} \end{cases}$$

$$q_A - q_B = \frac{dV_p}{dt}$$

$$L_F = \frac{V_p}{A}$$

$$L_{ef} = L_F \left(1 + \frac{L_{ad}}{L} \right)$$

$$h_p = L_F \frac{h_A - h_B}{L}$$

$$p = p_A - p_B + \rho \cdot g \cdot h_p$$

where

q_A, q_B	Flow rates through port A and B, respectively
p_A, p_B	Pressures at port A and B, respectively
h_A, h_B	Port A and port B elevations, respectively
L	Geometrical pipe length
L_{ad}	Aggregate equivalent length of local resistances

L_F	Pipe wet length
L_{ef}	Effective pipe length
ρ	Fluid density
p	Pressure differential across the pipe
V	Fluid volume in the upstream tank
V_p	Volume of fluid in the pipe
V_{min}	Minimum volume of fluid in the tank, or in the pipe. If V becomes less than V_{min} , then the upstream tank is considered empty, the flow rate through port A is assumed to be 0, and the tank pressurization pressure propagates through port A to the pipe. If V_p becomes less than V_{min} , then the pipe is considered empty and the flow rate through port B is assumed to be 0.
h_p	Fluid elevation in the pipe
Re_{cr}	Critical Reynolds number
g	Gravity acceleration

Flow rate A is considered positive when fluid flows into the pipe. Flow rate B is considered positive when fluid flows out of the pipe.

Basic Assumptions and Limitations

- The block is based on the assumption of steady-state fluid momentum conditions.
- Fluid inertia and fluid compressibility are not taken into account.
- Flow is assumed to be fully developed along the pipe length, therefore the end effects are not considered.
- To account for local resistances in the pipe, you must convert the resistances into their equivalent lengths, sum them up to obtain their aggregate length, and then add this aggregate length to the pipe geometrical length.
- The elevation of port A must be greater than that of port B.
- Port A must be connected to the hydraulic port of the top tank. The fluid volume in the top tank must be input into the Partially Filled Vertical Pipe LP block through the physical signal port V. If you use one of the standard Simscape Fluids reservoir or tank blocks, connect its physical output port directly to the input port V. If you use a custom tank block, it must have a port that exports fluid volume in the tank as a physical signal, and you must connect this output port to the input port V.
- Port B must not be exposed.
- The friction factor at turbulent regime is computed with the Haaland approximation.
- The friction factor at laminar regime is determined as the Poiseuille number divided by the Reynolds number.
- The friction factor during transition from laminar to turbulent regime is computed with the linear interpolation.

Parameters

- “Basic Parameters Tab” on page 1-1124

- “Vertical Position Tab” on page 1-1125

Basic Parameters Tab

Pipe type

The type of pipe cross section: **Circular** or **Noncircular**. For a circular pipe, you specify its internal diameter. For a noncircular pipe, you specify its hydraulic diameter and pipe cross-sectional area. The default value of the parameter is **Circular**.

Pipe internal diameter

Pipe internal diameter. The parameter is available if **Pipe type** is set to **Circular**. The default value is 0.01 m.

Noncircular pipe cross-sectional area

Pipe cross-sectional area. The parameter is available if **Pipe type** is set to **Noncircular**. The default value is 0.08 m².

Noncircular pipe hydraulic diameter

Hydraulic diameter of the pipe cross section. The parameter is available if **Pipe type** is set to **Noncircular**. The default value is 0.1 m.

Geometrical shape factor

Used for computing friction factor at laminar flow. The shape of the pipe cross section determines the value. For a pipe with a noncircular cross section, set the factor to an appropriate value, for example, 56 for a square, 96 for concentric annulus, 62 for rectangle (2:1), and so on [1 on page 1-1125]. The default value is 64, which corresponds to a pipe with a circular cross section.

Pipe length

Pipe geometrical length. The default value is 100 m.

Aggregate equivalent length of local resistances

Represents total equivalent length of all local resistances associated with the pipe. You can account for the pressure loss caused by local resistances, such as bends, fittings, armature, inlet/outlet losses, and so on, by adding to the pipe geometrical length an aggregate equivalent length of all the local resistances. The default value is 50 m.

Tank minimum volume

Minimum volume of fluid in the upstream tank, or in the pipe, corresponding to V_{\min} in the block equations. The tank or pipe is considered empty if its fluid volume becomes less than V_{\min} . The default value is 1e-4 m³.

Laminar flow upper margin

Specifies the Reynolds number at which the laminar flow regime is assumed to start converting into turbulent. Mathematically, this is the maximum Reynolds number at fully developed laminar flow. The default value is 2000.

Turbulent flow lower margin

Specifies the Reynolds number at which the turbulent flow regime is assumed to be fully developed. Mathematically, this is the minimum Reynolds number at turbulent flow. The default value is 4000.

Internal surface roughness height

Roughness height on the pipe internal surface. The parameter is typically provided in data sheets or manufacturer catalogs. The default value is 5e-5 m.

Vertical Position Tab

Port A elevation wrt reference plane

The vertical position of the pipe port A with respect to the reference plane. The default value is 50 m.

Port B elevation wrt reference plane

The vertical position of the pipe port B with respect to the reference plane. The default value is 0.

Restricted Parameters

When your model is in Restricted editing mode, you cannot modify the following parameter:

- **Pipe type**

All other block parameters are available for modification. The actual set of modifiable block parameters depends on the value of the **Pipe type** parameter at the time the model entered Restricted mode.

Global Parameters

Parameters determined by the type of working fluid:

- **Fluid density**
- **Fluid kinematic viscosity**

Use the Hydraulic Fluid block or the Custom Hydraulic Fluid block to specify the fluid properties.

Ports

The block has the following ports:

A

Hydraulic conserving port associated with the pipe inlet.

B

Hydraulic conserving port associated with the pipe outlet.

V

Physical signal input port that provides data on fluid volume in the upstream tank.

L

Physical signal output port that exports the pipe fluid level.

References

[1] White, F.M., *Viscous Fluid Flow*, McGraw-Hill, 1991

Extended Capabilities

C/C++ Code Generation

Generate C and C++ code using Simulink® Coder™.

See Also

Hydraulic Pipe LP with Variable Elevation | Resistive Pipe LP with Variable Elevation

Topics

“Upgrading Simscape Fluids Models Containing Hydraulics (Isothermal) Blocks”

Introduced in R2013a

Pilot-Operated Check Valve

Hydraulic check valve that allows flow in one direction, but can be disabled by pilot pressure



Library

Directional Valves

Description

The Pilot-Operated Check Valve block represents a hydraulic pilot-operated check valve as a data-sheet-based model. The purpose of the check valve is to permit flow in one direction and block it in the opposite direction, as shown in the following figure.

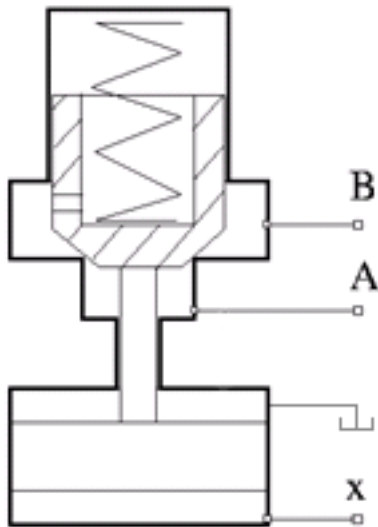

Unlike a conventional check valve, the pilot-operated check valve can be opened by inlet pressure p_A , pilot pressure p_X , or both. The force acting on the poppet is based on the expression

$$F = p_A \cdot A_A + p_X \cdot A_X - p_B \cdot A_B$$

where

p_A, p_B	Gauge pressures at the valve terminals
p_X	Pressure—gauge or differential—at the pilot terminal
A_A	Area of the spool in the A chamber

A_B	Area of the spool in the B chamber
A_X	Area of the pilot chamber

The force equation is commonly expressed in the slightly modified form

$$p_e = p_A + p_X \cdot k_p - p_B$$

where $k_p = A_X / A_A$ is usually referred to as pilot ratio and p_e is the effective pressure differential across the control member. The valve remains closed while this pressure differential across the valve is lower than the valve cracking pressure. When cracking pressure is reached, the valve control member is forced off its seat, thus creating a passage between the inlet and outlet. If the flow rate is high enough and pressure continues to rise, the area is further increased until the control member reaches its maximum. At this moment, the valve passage area is at its maximum. The valve maximum area and the cracking and maximum pressures are generally provided in the catalogs and are the three key parameters of the block.

The pilot pressure can be a differential value relative to the inlet (port **A**) or a gauge value (relative to the environment). You can select an appropriate setting—**Pressure differential (pX - pA)** or **Pressure at port X**—using the **Pressure control specification** dropdown list. If **Pressure at port X** is selected:

$$p_X = p_{X,Abs} - p_{Atm}$$

where the subscript *Atm* denotes atmospheric pressure. The subscript *X, Abs* denotes the absolute value at the pilot port. If **Pressure differential (pX - pA)** is selected:

$$p_X = p_{X,Abs} - p_{A,Abs}$$

where the subscript *A, Abs* similarly denotes the absolute value at the inlet of the valve (port **A**). The pilot pressure differential is constrained to be greater than or equal to zero—if its calculated value should be negative, zero is assumed in the control pressure calculation.

In addition to the maximum area, the leakage area is also required to characterize the valve. The main purpose of the parameter is not to account for possible leakage, even though this is also important, but to maintain numerical integrity of the circuit by preventing a portion of the system from getting isolated after the valve is completely closed. An isolated or “hanging” part of the system could affect computational efficiency and even cause failure of computation. Therefore, the parameter value must be greater than zero.

By default, the block does not include valve opening dynamics, and the valve sets its opening area directly as a function of pressure:

$$A = A(p)$$

Adding valve opening dynamics provides continuous behavior that is more physically realistic, and is particularly helpful in situations with rapid valve opening and closing. The pressure-dependent orifice passage area $A(p)$ in the block equations then becomes the steady-state area, and the instantaneous orifice passage area in the flow equation is determined as follows:

$$A(t = 0) = A_{init}$$

$$\frac{dA}{dt} = \frac{A(p) - A}{\tau}$$

In either case, the flow rate through the valve is determined according to the following equations:

$$q = C_D \cdot A \sqrt{\frac{2}{\rho}} \cdot \frac{p}{(p^2 + p_{cr}^2)^{1/4}}$$

$$p_e = p_A + p_X \cdot k_p - p_B$$

$$A(p) = \begin{cases} A_{leak} & \text{for } p_e \leq p_{crack} \\ A_{leak} + k \cdot (p_e - p_{crack}) & \text{for } p_{crack} < p_e < p_{max} \\ A_{max} & \text{for } p_e \geq p_{max} \end{cases}$$

$$k = \frac{A_{max} - A_{leak}}{p_{max} - p_{crack}}$$

$$\Delta p = p_A - p_B,$$

$$p_{cr} = \frac{\rho}{2} \left(\frac{Re_{cr} \cdot \nu}{C_D \cdot D_H} \right)^2$$

$$D_H = \sqrt{\frac{4A}{\pi}}$$

where

q	Flow rate through the valve
p	Pressure differential across the valve
p_e	Equivalent pressure differential across the control member
p_A, p_B	Gauge pressures at the valve terminals
p_X	Gauge pressure at the pilot terminal
k_p	Pilot ratio, $k_p = A_X / A_A$
k	Valve gain coefficient
C_D	Flow discharge coefficient
A	Instantaneous orifice passage area
$A(p)$	Pressure-dependent orifice passage area
A_{init}	Initial open area of the valve
A_{max}	Fully open valve passage area
A_{leak}	Closed valve leakage area
p_{crack}	Valve cracking pressure
p_{max}	Pressure needed to fully open the valve
p_{cr}	Minimum pressure for turbulent flow
Re_{cr}	Critical Reynolds number
D_H	Instantaneous orifice hydraulic diameter
ρ	Fluid density
ν	Fluid kinematic viscosity
τ	Time constant for the first order response of the valve opening

t	Time
-----	------

The block positive direction is from port A to port B. This means that the flow rate is positive if it flows from A to B, and the pressure differential is determined as $\Delta p = p_A - p_B$.

Basic Assumptions and Limitations

- Valve opening is linearly proportional to the effective pressure differential.
- No loading on the valve, such as inertia, friction, spring, and so on, is considered.
- No flow consumption is associated with the pilot chamber.

Parameters

Pressure control specification

Choice of pressure measurement to use as pilot control signal. The block uses the chosen measurement to calculate the effective pressure differential across the valve. (See the block description for the calculations.)

In the default setting (**Pressure differential (pX - pA)**), the effective pressure differential is a function of the pressure drop from the pilot port (**X**) to the inlet (**A**). In the alternate setting (**Pressure at port X**), it is a function of the gauge pressure at the inlet.

Cracking pressure

Pressure level at which the orifice of the valve starts to open. The default value is $3e4$ Pa.

Maximum opening pressure

Pressure differential across the valve needed to fully open the valve. Its value must be higher than the cracking pressure. The default value is $1.2e5$ Pa.

Pilot ratio

Ratio between effective area in the pilot chamber to the effective area in the inlet chamber. The default value is 5.

Maximum passage area

Valve passage maximum cross-sectional area. The default value is $1e-4$ m².

Leakage area

The total area of possible leaks in the completely closed valve. The main purpose of the parameter is to maintain numerical integrity of the circuit by preventing a portion of the system from getting isolated after the valve is completely closed. The parameter value must be greater than 0. The default value is $1e-12$ m².

Laminar transition specification

Select how the block transitions between the laminar and turbulent regimes:

- **Pressure ratio** — The transition from laminar to turbulent regime is smooth and depends on the value of the **Laminar flow pressure ratio** parameter. This method provides better simulation robustness.
- **Reynolds number** — The transition from laminar to turbulent regime is assumed to take place when the Reynolds number reaches the value specified by the **Critical Reynolds number** parameter.

Laminar flow pressure ratio

Pressure ratio at which the flow transitions between laminar and turbulent regimes. The default value is 0.999. This parameter is visible only if the **Laminar transition specification** parameter is set to `Pressure ratio`.

Critical Reynolds number

The maximum Reynolds number for laminar flow. The value of the parameter depends on the orifice geometrical profile. You can find recommendations on the parameter value in hydraulics textbooks. The default value is 12, which corresponds to a round orifice in thin material with sharp edges. This parameter is visible only if the **Laminar transition specification** parameter is set to `Reynolds number`.

Flow discharge coefficient

Semi-empirical parameter for valve capacity characterization. Its value depends on the geometrical properties of the orifice, and usually is provided in textbooks or manufacturer data sheets. The default value is 0.7.

Opening dynamics

Select one of the following options:

- **Do not include valve opening dynamics** — The valve sets its orifice passage area directly as a function of pressure. If the area changes instantaneously, so does the flow equation. This is the default.
- **Include valve opening dynamics** — Provide continuous behavior that is more physically realistic, by adding a first-order lag during valve opening and closing. Use this option in hydraulic simulations with the local solver for real-time simulation. This option is also helpful if you are interested in valve opening dynamics in variable step simulations.

Opening time constant

The time constant for the first order response of the valve opening. This parameter is available only if **Opening dynamics** is set to `Include valve opening dynamics`. The default value is 0.1 s.

Initial area

The initial opening area of the valve. This parameter is available only if **Opening dynamics** is set to `Include valve opening dynamics`. The default value is $1e-12 \text{ m}^2$.

Restricted Parameters

When your model is in Restricted editing mode, you cannot modify the following parameter:

- **Opening dynamics**

All other block parameters are available for modification. The actual set of modifiable block parameters depends on the value of the **Opening dynamics** parameter at the time the model entered Restricted mode.

Global Parameters

Parameters determined by the type of working fluid:

- **Fluid density**
- **Fluid kinematic viscosity**

Use the Hydraulic Fluid block or the Custom Hydraulic Fluid block to specify the fluid properties.

Ports

The block has the following ports:

A

Hydraulic conserving port associated with the valve inlet.

B

Hydraulic conserving port associated with the valve outlet.

X

Hydraulic conserving port associated with the valve pilot terminal.

Extended Capabilities

C/C++ Code Generation

Generate C and C++ code using Simulink® Coder™.

See Also

Check Valve

Topics

“Upgrading Simscape Fluids Models Containing Hydraulics (Isothermal) Blocks”

Introduced in R2006a

Pilot-Operated Check Valve (IL)

Check valve with pilot pressure control in an isothermal liquid system

Library: Simscape / Fluids / Isothermal Liquid / Valves & Orifices / Directional Control Valves



Description

The Pilot-Operated Check Valve (IL) block models a flow-control valve with variable flow directionality based on the pilot-line pressure. Flow is normally restricted to travel from port **A** to port **B** in either a connected or disconnected spool-poppet configuration, according to the **Pilot configuration** parameter.

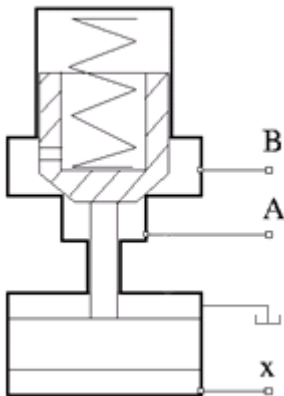

Pilot-Operated Check Valve Schematic

The control pressure, p_{control} is:

$$p_{\text{control}} = p_{\text{pilot}}k_p + (p_A - p_B),$$

where:

- p_{pilot} is the control pilot pressure differential.
- k_p is the **Pilot ratio**, the ratio of the area at port **X** to the area at port **A**: $k_p = \frac{A_X}{A_A}$.
- $p_A - p_B$ is the pressure differential over the valve.

When the control pressure exceeds the **Cracking pressure differential**, the poppet moves to allow flow from port **B** to port **A**.

There is no mass flow between port **X** and ports **A** and **B**.

Valve Pressure Control with a Pilot Port

The pilot pressure differential for valve control can be configured in two ways:

- When the **Opening pilot pressure specification** parameter is set to Pressure at port X relative to port A, the pilot pressure is the pressure differential between port X and port A.
- When **Opening pilot pressure specification** is set to Pressure at port X relative to atmospheric pressure, the pilot pressure is the pressure difference between port X and atmospheric pressure.

When **Pilot configuration** is set to Disconnected pilot spool and poppet, the relative pressure at port X must be positive. If the measured pilot pressure is negative, the control pressure is only based on the pressure differential between ports A and B. In the Rigidly connected pilot spool and poppet setting, the pilot pressure is the measured pressure differential according to the opening specification.

Mass Flow Rate Equation

Mass is conserved through the valve:

$$\dot{m}_A + \dot{m}_B = 0.$$

The mass flow rate through the valve is calculated as:

$$\dot{m} = \frac{C_d A_{\text{valve}} \sqrt{2\bar{\rho}}}{\sqrt{PR_{\text{loss}} \left(1 - \left(\frac{A_{\text{valve}}}{A_{\text{port}}}\right)^2\right) [\Delta p^2 + \Delta p_{\text{crit}}^2]^{1/4}} \Delta p$$

where:

- C_d is the **Discharge coefficient**.
- A_{valve} is the instantaneous valve open area.
- A_{port} is the **Cross-sectional area at ports A and B**.
- $\bar{\rho}$ is the average fluid density.
- Δp is the valve pressure difference, $p_A - p_B$.

The critical pressure difference, Δp_{crit} , is the pressure differential associated with the **Critical Reynolds number**, Re_{crit} , the flow regime transition point between laminar and turbulent flow:

$$\Delta p_{\text{crit}} = \frac{\pi \bar{\rho}}{8 A_{\text{valve}}} \left(\frac{\nu Re_{\text{crit}}}{C_d} \right)^2.$$

Pressure loss describes the reduction of pressure in the valve due to a decrease in area. PR_{loss} is calculated as:

$$PR_{\text{loss}} = \frac{\sqrt{1 - \left(\frac{A_{\text{valve}}}{A_{\text{port}}}\right)^2 (1 - C_d^2)} - C_d \frac{A_{\text{valve}}}{A_{\text{port}}}}{\sqrt{1 - \left(\frac{A_{\text{valve}}}{A_{\text{port}}}\right)^2 (1 - C_d^2)} + C_d \frac{A_{\text{valve}}}{A_{\text{port}}}}.$$

Pressure recovery describes the positive pressure change in the valve due to an increase in area. If you do not wish to capture this increase in pressure, set the **Pressure recovery** to Off. In this case, PR_{loss} is 1.

The opening area, A_{valve} , is also impacted by the valve opening dynamics.

Opening Parameterization

The linear parameterization of the valve area is

$$A_{\text{valve}} = \hat{p}(A_{\text{max}} - A_{\text{leak}}) + A_{\text{leak}},$$

where the normalized pressure, \hat{p} , is

$$\hat{p} = \frac{p_{\text{control}} - p_{\text{cracking}}}{p_{\text{max}} - p_{\text{cracking}}}.$$

When the **Smoothing factor**, s , is nonzero, a smoothed, normalized pressure is instead applied to the valve area:

$$\hat{p}_{\text{smoothed}} = \frac{1}{2} + \frac{1}{2} \sqrt{\hat{p}^2 + \left(\frac{s}{4}\right)^2} - \frac{1}{2} \sqrt{(\hat{p} - 1)^2 + \left(\frac{s}{4}\right)^2}.$$

Opening Dynamics

If opening dynamics are modeled, a lag is introduced to the flow response to the modeled control pressure. p_{control} becomes the dynamic control pressure, p_{dyn} ; otherwise, p_{control} is the steady-state pressure. The instantaneous change in dynamic control pressure is calculated based on the **Opening time constant**, τ :

$$\dot{p}_{\text{dyn}} = \frac{p_{\text{control}} - p_{\text{dyn}}}{\tau}.$$

By default, **Opening dynamics** is set to Off.

Ports

Conserving

A – Liquid port

isothermal liquid

Liquid entry point to the valve. When the control pressure exceeds the cracking pressure, liquid is able to exit from this port.

B – Liquid port

isothermal liquid

Liquid exit point from the valve. When the control pressure exceeds the cracking pressure, liquid is able to enter the valve from this port.

X – Pressure port

isothermal liquid

Pressure port that contributes to the flow control through the valve.

Parameters

Pilot configuration — Valve geometry

Rigidly connected pilot spool and poppet (default) | Disconnected pilot spool and poppet

Valve geometry. The valve can either have an opening mechanism that is connected to the valve poppet, in the case of the Rigidly connected pilot spool and poppet setting, or an opening mechanism that is aligned with, but moves freely away from, the valve poppet, in the case of the Disconnected pilot spool and poppet setting. The configuration choice determines the pilot pressure calculation.

Opening pilot pressure specification — Reference pressure differential for valve control

Pressure at port X relative to port A (default) | Pressure at port X relative to atmospheric pressure

Reference pressure differential used for valve control. This differential defines the pilot pressure differential, which is added to the pressure differential between ports **A** and **B** and compared against the valve threshold **Cracking pressure differential**.

Cracking pressure differential — Pressure threshold

0.01 MPa (default) | positive scalar

Set pressure for the valve operation.

Maximum opening pressure differential — Maximum pressure differential in opened valve

0.02 MPa (default) | positive scalar

Maximum pressure differential in an opened valve. This value provides an upper limit to simulation pressures so that results remain physical.

Pilot ratio — Pilot port area ratio

1 (default) | positive scalar in the range of (0,1]

Ratio of port area **X** to port area **A**.

Maximum opening area — Maximum valve area

1e-4 m² (default) | positive scalar

Maximum valve area. This value is used to determine the normalized valve pressure and the valve opening area during operation.

Leakage area — Gap area when in fully closed position

1e-10 m² (default) | positive scalar

Sum of all gaps when the valve is in the fully closed position. Any area smaller than this value is saturated to the specified leakage area. This contributes to numerical stability by maintaining continuity in the flow.

Cross-sectional area at ports A and B — Area at conserving ports

inf m² (default) | positive scalar

Areas at the entry and exit ports **A** and **B**, which are used in the pressure-flow rate equation that determines the mass flow rate through the valve.

Discharge coefficient – Discharge coefficient

0.64 (default) | positive scalar

Correction factor accounting for discharge losses in theoretical flows.

Critical Reynolds number – Upper Reynolds number limit for laminar flow

12 (default) | positive scalar

Upper Reynolds number limit for laminar flow through the orifice.

Smoothing factor – Numerical smoothing factor

0.01 (default) | positive scalar in the range [0,1]

Continuous smoothing factor that introduces a layer of gradual change to the flow response when the valve is in near-open or near-closed positions. Set this value to a nonzero value less than one to increase the stability of your simulation in these regimes.

Pressure recovery – Whether to account for pressure increase in area expansions

Off (default) | On

Whether to account for pressure increase when fluid flows from a region of smaller cross-sectional area to a region of larger cross-sectional area.

Opening dynamics – Whether to introduce flow lag due to valve opening

Off (default) | On

Whether to account for transient effects to the fluid system due to opening the valve. Setting **Opening dynamics** to On approximates the opening conditions by introducing a first-order lag in the pressure response. The **Opening time constant** also impacts the modeled opening dynamics.

Opening time constant – Valve opening time constant

0.1 s (default) | positive scalar

Constant that captures the time required for the fluid to reach steady-state conditions when opening or closing the valve from one position to another. This parameter impacts the modeled opening dynamics.

Dependencies

To enable this parameter, set **Opening dynamics** to On.

See Also

Check Valve (IL) | Check Valve (TL) | Pressure Relief Valve (IL) | Counterbalance Valve (IL) | Pressure Compensator Valve (IL)

Introduced in R2020a

Pilot-Operated Check Valve (TL)

Check valve with control port to enable flow in reverse direction

Library: Simscape / Fluids / Thermal Liquid / Valves & Orifices / Directional Control Valves



Description

The Pilot-Operated Check Valve (TL) block models a check valve with an override mechanism to allow for backflow when activated. (A check valve in turn is an orifice with a unidirectional opening mechanism installed to prevent just that backflow.)

The override mechanism adds a third port—the *pilot*—to the valve. During normal operation, the pilot port is inactive and the valve behaves as any other check valve. Its orifice is then open only when the pressure gradient across it drops from inlet to outlet. Backflow, which requires the reverse pressure gradient, cannot occur. This mode protects components upstream of the valve against pressure surges, temperature spikes, and (in real systems) chemical contamination arising from points downstream.

When backflow is desired, the pilot port is pressurized and the control element of the valve—often a ball or piston—is forced off its seat. The valve is then open to flow in both directions, with a reverse pressure drop (aimed from outlet to inlet) sufficing to drive the flow upstream. (The seat, which lies in the path of the flow, determines if the valve is open. When it is covered—by a ball, piston, or other control element—the flow is cut off and the valve is closed.)

The valve opens by degrees, beginning at its cracking pressure, and continuing to the end of its pressure regulation range. The cracking pressure gives the initial resistance, due to friction or spring forces, that the valve must overcome to open by a sliver (or to *crack* open). Below this threshold, the valve is closed and only leakage flow can pass. Past the end of the pressure regulation range, the valve is fully open and the flow at a maximum (determined by the instantaneous pressure conditions).

The cracking pressure assumes an important role in check valves installed upside down. There, the weight of the opening element—such as a ball or piston—and the elevation head of the fluid can act to open the valve. (The elevation head can arise in a model from a pipe upstream of the inlet when it is vertical or given a slant.) A sufficient cracking pressure keeps the valve from opening inadvertently even if placed at a disadvantageous angle.

Control Pressure

The opening of the valve depends both on the pilot pressure and on the pressure drop from inlet to outlet:

$$p_{\text{Ctl}} = k_X p_X + p_A - p_B,$$

where p is gauge pressure and k is the pilot ratio—the proportion of the pilot opening area (S_X) to the valve opening area (S_R). The subscript X denotes a pilot value and the subscripts A and B the inlet and outlet values, respectively. The port pressures are variables determined (against absolute zero) during simulation.

The pilot pressure can be a differential value relative to the inlet (port **A**) or a gauge value (relative to the environment). You can select an appropriate setting—**Pressure differential (pX - pA)** or **Pressure at port X**—using the **Pressure control specification** dropdown list. If **Pressure at port X** is selected:

$$p_X = p_{X,Abs} - p_{Atm},$$

where the subscript **Atm** denotes the atmospheric value (obtained from the Thermal Liquid Settings (TL) or Thermal Liquid Properties (TL) block of the model). The subscript **X, Abs** denotes the absolute value at the pilot port. If **Pressure differential (pX - pA)** is selected:

$$p_X = p_{X,Abs} - p_{A,Abs}$$

where the subscript **A, Abs** similarly denotes the absolute value at the inlet of the valve (port **A**). The pilot pressure differential is constrained to be greater than or equal to zero—if its calculated value should be negative, zero is assumed in the control pressure calculation.

Control Pressure Overshoot

The degree to which the control pressure exceeds the cracking pressure determines how much the valve will open. The pressure overshoot is expressed here as a fraction of the (width of the) pressure regulation range:

$$\hat{p} = \frac{p_{Ctl} - P_{Crk}}{P_{Max} - P_{Crk}}.$$

The control pressure (p_{Ctl}), cracking pressure (p_{Set}), and maximum opening pressure (P_{Max}) correspond to the control pressure specification chosen (**Pressure differential** or **Pressure at port A**).

The fraction—technically, the overshoot *normalized*—is valued at **0** in the fully closed valve and **1** in the fully open valve. If the calculation should return a value outside of these bounds, the nearest of the two is used instead. (In other words, the fraction *saturates* at **0** and **1**.)

Numerical Smoothing

The normalized control pressure, p , spans three pressure regions. Below the cracking pressure of the valve, its value is a constant zero. Above the maximum pressure of the same, it is **1**. In between, it varies, as a linear function of the (effective) control pressure, p_{Ctl} .

The transitions between the regions are sharp and their slopes discontinuous. These pose a challenge to variable-step solvers (the sort commonly used with Simscape models). To precisely capture discontinuities, referred to in some contexts as *zero crossing events*, the solver must reduce its time step, pausing briefly at the time of the crossing in order to recompute its Jacobian matrix (a representation of the dependencies between the state variables of the model and their time derivatives).

This solver strategy is efficient and robust when discontinuities are present. It makes the solver less prone to convergence errors—but it can considerably extend the time needed to finish the simulation run, perhaps excessively so for practical use in real-time simulation. An alternative approach, used here, is to remove the discontinuities altogether.

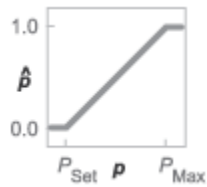

Normalized temperature overshoot with sharp transitions

The block removes the discontinuities by smoothing them over a specified time scale. The smoothing, which adds a slight distortion to the normalized inlet pressure, ensures that the valve eases into its limiting positions rather than snap (abruptly) into them. The smoothing is optional: you can disable it by setting its time scale to zero. The shape and scale of the smoothing, when applied, derives in part from the cubic polynomials:

$$\lambda_L = 3\bar{p}_L^2 - 2\bar{p}_L^3$$

and

$$\lambda_R = 3\bar{p}_R^2 - 2\bar{p}_R^3,$$

where

$$\bar{p}_L = \frac{\hat{p}}{\Delta p^*}$$

and

$$\bar{p}_R = \frac{\hat{p} - (1 - \Delta p^*)}{\Delta p^*}.$$

In the equations:

- λ_L is the smoothing expression for the transition from the maximally closed position.
- λ_R is the smoothing expression for the transition from the fully open position.
- Δp^* is the (unitless) characteristic width of the pressure smoothing region:

$$\Delta p^* = f^* \frac{1}{2},$$

where f^* is a smoothing factor valued between 0 and 1 and obtained from the block parameter of the same name.

When the smoothing factor is 0, the normalized inlet pressure stays in its original form—no smoothing applied—and its transitions remain abrupt. When it is 1, the smoothing spans the whole of the pressure regulation range (with the normalized inlet pressure taking the shape of an S-curve).

At intermediate values, the smoothing is limited to a fraction of that range. A value of 0.5, for example, will smooth the transitions over a quarter of the pressure regulation range on each side (for a total smooth region of half the regulation range).

The smoothing adds two new regions to the normalized pressure overshoot—one for the smooth transition on the left, another for that on the right, giving a total of five regions. These are expressed in the piecewise function:

$$\hat{p}^* = \begin{cases} 0, & \hat{p} \leq 0 \\ \hat{p}\lambda_L, & \hat{p} < \Delta P^* \\ \hat{p}, & \hat{p} \leq 1 - \Delta P^* \\ \hat{p}(1 - \lambda_R) + \lambda_R, & \hat{p} < 1 \\ 1 & \hat{p} \geq 1 \end{cases}$$

where the asterisk denotes a smoothed variable (the normalized control pressure overshoot). The figure shows the effect of smoothing on the sharpness of the transitions.

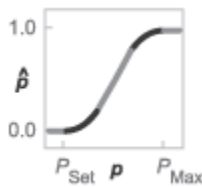

Opening Area

The valve is assumed to open linearly with the smoothed control pressure overshoot:

$$S = (S_{\text{Max}} - S_{\text{Min}})\hat{p} + S_{\text{Min}}$$

where S is sonic conductance and the subscripts Max and Min denote its values in the fully open and fully closed valve. In terms of the smoothed control pressure overshoot, the opening area becomes:

$$S^* = (S_{\text{Max}} - S_{\text{Min}})\hat{p}^* + S_{\text{Min}}$$

(Both expressions are used in the calculation of the pressure drop across the valve.)

Momentum Balance

The causes of those pressure losses incurred in the passages of the valve are ignored in the block. Whatever their natures—sudden area changes, flow passage contortions—only their cumulative effect is considered during simulation. This effect is captured in the block by the discharge coefficient, a measure of the mass flow rate through the valve relative to the theoretical value that it would have in an ideal valve. Expressing the momentum balance in the valve in terms of the pressure drop induced in the flow:

$$p_A - p_B = \frac{\dot{m}_{\text{Avg}}\sqrt{\dot{m}_{\text{Avg}}^2 + \dot{m}_{\text{Crit}}^2}}{2\rho_{\text{Avg}}C_D S^{*2}} \left[1 - \left(\frac{S^*}{S} \right)^2 \right] \xi_p,$$

where ρ is density, C_D is the discharge coefficient, and ξ_p is the pressure drop ratio—a measure of the extent to which the pressure recovery at the outlet contributes to the total pressure drop of the valve. The subscript Avg denotes an average of the values at the thermal liquid ports. The critical mass flow rate, \dot{m}_{Crit} , is calculated from the critical Reynolds number—that at which the flow in the valve is assumed to transition from laminar to turbulent:

$$\dot{m}_{\text{Crit}} = \text{Re}_{\text{Crit}}\mu_{\text{Avg}}\sqrt{\frac{\pi}{4}S},$$

where μ denotes dynamic viscosity. The pressure drop ratio is calculated as:

$$\xi_p = \frac{\sqrt{1 - \left(\frac{S^*}{S}\right)^2 (1 - C_D^2)} - C_D \frac{S^*}{S}}{\sqrt{1 - \left(\frac{S^*}{S}\right)^2 (1 - C_D^2)} + C_D \frac{S^*}{S}}.$$

Mass Balance

The volume of fluid inside the valve, and therefore the mass of the same, is assumed to be very small and it is, for modeling purposes, ignored. As a result, no amount of fluid can accumulate there. By the principle of conservation of mass, the mass flow rate into the valve through one port must therefore equal that out of the valve through the other port:

$$\dot{m}_A + \dot{m}_B = 0,$$

where \dot{m} is defined as the mass flow rate *into* the valve through port **A** or **B**.

Energy Balance

The valve is modeled as an adiabatic component. No heat exchange can occur between the fluid and the wall that surrounds it. No work is done on or by the fluid as it traverses from inlet to outlet. With these assumptions, energy can flow by advection only, through ports **A** and **B**. By the principle of conservation of energy, the sum of the port energy flows must then always equal zero:

$$\phi_A + \phi_B = 0,$$

where ϕ is defined as the energy flow rate *into* the valve through one of the ports (**A** or **B**).

Ports

Conserving

A – Valve entrance

thermal liquid

Opening through which the working fluid must, during normal operation (when the pilot mechanism is disabled), enter the valve. This port can serve as an exit only when the pilot port is pressurized to a sufficient degree.

B – Valve entrance

thermal liquid

Opening through which the working fluid must, during normal operation (when the pilot mechanism is disabled), exit the valve.

X – Pilot port

thermal liquid

Opening by which to actuate (by the application of a sufficient pressure) the pilot mechanism that opens the valve for reverse flow.

Parameters

Pressure control specification — Choice of pressure measurement to use as valve control signal

Pressure differential (pX-pA) (default) | Pressure at port X

Choice of pressure measurement to use as pilot control signal. The block uses the chosen measurement to calculate the control pressure of the valve. (See the block description for the calculations.)

In the default setting (Pressure differential (pX - pA)), the control pressure is a function of the pressure drop from the pilot port (X) to the inlet (A). In the alternate setting (**Pressure at port X**), it is a function of the gauge pressure at the inlet.

Cracking pressure differential — Effective control pressure at which the valve first opens

0.01 MPa (default) | positive scalar in units of pressure

Effective pressure differential at which the valve begins to open. This differential—the *control pressure* in the block description—is the sum of the pressure drop from inlet to outlet with the product of the pilot pressure and the pilot ratio. (The pilot pressure used depends on the setting of the **Pressure control specification** parameter.)

Maximum opening pressure differential — Effective control pressure at which the valve is fully open

0.02 MPa (default) | positive scalar in units of pressure

Effective pressure differential at which the valve is fully open. This differential—the *control pressure* in the block description—is the sum of the pressure drop from inlet to outlet with the product of the pilot pressure and the pilot ratio. (The pilot pressure used depends on the setting of the **Pressure control specification** parameter.)

Pilot ratio — Ratio of pilot port area to inlet port area

1 (default) | positive unitless scalar

Ratio of the pilot port area to the inlet port area.

Maximum opening area — Opening area in the fully open position due to sealing imperfections

1e-4 m² (default) | positive scalar in units of area

Opening area of the valve in the fully open position, when the valve is at the upper limit of the pressure regulation range.

Leakage area — Opening area in the maximally closed position due to sealing imperfections

1e-10 m² (default) | positive scalar in units of area

Opening area of the valve in the maximally closed position, when only internal leakage between the ports remains. This parameter serves primarily to ensure that closure of the valve does not cause portions of the fluid network to become isolated (a condition known to cause problems in simulation). The exact value specified here is less important than its being a (very small) number greater than zero.

Smoothing factor — Amount of smoothing to apply to the valve opening area function

0 (default)

Amount of smoothing to apply to the opening area function of the valve. This parameter determines the widths of the regions to be smoothed—one located at the fully open position, the other at the fully closed position.

The smoothing superposes on each region of the opening area function a nonlinear segment (a third-order polynomial function, from which the smoothing arises). The greater the value specified here, the greater the smoothing is, and the broader the nonlinear segments become.

At the default value of 0, no smoothing is applied. The transitions to the maximally closed and fully open positions then introduce discontinuities (associated with zero-crossings), which tend to slow down the rate of simulation.

Cross-sectional area at ports A and B — Area normal to the flow path at the valve ports

0.01 m² (default) | positive scalar in units of area

Area normal to the flow path at the valve ports. The ports are assumed to be the same in size. The flow area specified here should ideally match those of the inlets of adjoining components.

Characteristic longitudinal length — Measure of the length of the flow path through the valve

0.1 (default) | positive scalar in units of length

Average distance traversed by the fluid as it travels from inlet to outlet. This distance is used in the calculation of the internal thermal conduction that occurs between the two ports (as part of the smoothed upwind energy scheme employed in the thermal liquid domain).

Discharge coefficient — Empirical factor defined as the ratio of actual to ideal mass flow rates

0.7 (default) | positive unitless scalar

Ratio of the actual flow rate through the valve to the theoretical value that it would have in an ideal valve. This semi-empirical parameter measures the flow allowed through the valve: the greater its value, the greater the flow rate. Refer to the valve data sheet, if available, for this parameter.

Critical Reynolds number — Reynolds number at the boundary between laminar and turbulent flow regimes

12 (default) | positive unitless scalar

Reynolds number at which the flow is assumed to transition between laminar and turbulent regimes.

Extended Capabilities**C/C++ Code Generation**

Generate C and C++ code using Simulink® Coder™.

See Also

2-Way Directional Valve (TL) | Variable Area Orifice (TL) | 3-Way Directional Valve (TL) | Check Valve (TL)

Introduced in R2018b

Pilot-Operated Check Valve (G)

Check valve with control port to enable flow in reverse direction

Library: Simscape / Fluids / Gas / Valves & Orifices / Directional Control Valves



Description

The Pilot-Operated Check Valve (G) block models a check valve with an override mechanism to allow for backflow when activated. (A check valve in turn is an orifice with a unidirectional opening mechanism installed to prevent just that backflow.)

The override mechanism adds a third port—the *pilot*—to the valve. During normal operation, the pilot port is inactive and the valve behaves as any other check valve. Its orifice is then open only when the pressure gradient across it drops from inlet to outlet. Backflow, which requires the reverse pressure gradient, cannot occur. This mode protects components upstream of the valve against pressure surges, temperature spikes, and (in real systems) chemical contamination arising from points downstream.

When backflow is desired, the pilot port is pressurized and the control element of the valve—often a ball or piston—is forced off its seat. The valve is then open to flow in both directions, with a reverse pressure drop (aimed from outlet to inlet) sufficing to drive the flow upstream. (The seat, which lies in the path of the flow, determines if the valve is open. When it is covered—by a ball, piston, or other control element—the flow is cut off and the valve is closed.)

The valve opens by degrees, beginning at its cracking pressure, and continuing to the end of its pressure regulation range. The cracking pressure gives the initial resistance, due to friction or spring forces, that the valve must overcome to open by a sliver (or to *crack* open). Below this threshold, the valve is closed and only leakage flow can pass. Past the end of the pressure regulation range, the valve is fully open and the flow at a maximum (determined by the instantaneous pressure conditions).

The cracking pressure assumes an important role in check valves installed upside down. There, the weight of the opening element—such as a ball or piston—and the elevation head of the fluid can act to open the valve. (The elevation head can arise in a model from a pipe upstream of the inlet when it is vertical or given a slant.) A sufficient cracking pressure keeps the valve from opening inadvertently even if placed at a disadvantageous angle.

The flow can be laminar or turbulent, and it can reach (up to) sonic speeds. This happens at the vena contracta, a point just past the throat of the valve where the flow is both its narrowest and fastest. The flow then chokes and its velocity saturates, with a drop in downstream pressure no longer sufficing to increase its velocity. Choking occurs when the back-pressure ratio hits a critical value characteristic of the valve. Supersonic flow is not captured by the block.

Control and Other Pressures

The opening of the valve depends both on the pilot pressure and on the pressure drop from inlet to outlet:

$$p_{\text{Ctl}} = k_X p_X + p_A - p_B,$$

where p is gauge pressure and k is the pilot ratio—the proportion of the pilot opening area (S_X) to the valve opening area (S_R). The subscript X denotes a pilot value and the subscripts A and B the inlet and outlet values, respectively. The port pressures are variables determined (against absolute zero) during simulation.

The pilot pressure can be a differential value relative to the inlet (port **A**) or a gauge value (relative to the environment). You can select an appropriate setting—**Pressure differential (pX - pA)** or **Pressure at port X**—using the **Pressure control specification** dropdown list. If **Pressure at port X** is selected:

$$p_X = p_{X,\text{Abs}} - p_{\text{Atm}},$$

where the subscript **Atm** denotes the atmospheric value (obtained from the Gas Properties (G) block of the model). The subscript **X, Abs** denotes the absolute value at the pilot port. If **Pressure differential (pX - pA)** is selected:

$$p_X = p_{X,\text{Abs}} - p_{A,\text{Abs}}$$

where the subscript **A, Abs** similarly denotes the absolute value at the inlet of the valve (port **A**). The pilot pressure differential is constrained to be greater than or equal to zero—if its calculated value should be negative, zero is assumed in the control pressure calculation.

Control Pressure Overshoot

The degree to which the control pressure exceeds the cracking pressure determines how much the valve will open. The pressure overshoot is expressed here as a fraction of the (width of the) pressure regulation range:

$$\hat{p} = \frac{p_{\text{Ctl}} - P_{\text{Crk}}}{P_{\text{Max}} - P_{\text{Crk}}}.$$

The control pressure (p_{Ctl}), cracking pressure (p_{Set}), and maximum opening pressure (P_{Max}) correspond to the control pressure specification chosen (**Pressure differential** or **Pressure at port A**).

The fraction—technically, the overshoot *normalized*—is valued at 0 in the fully closed valve and 1 in the fully open valve. If the calculation should return a value outside of these bounds, the nearest of the two is used instead. (In other words, the fraction *saturates* at 0 and 1.)

Numerical Smoothing

The normalized control pressure, p , spans three pressure regions. Below the cracking pressure of the valve, its value is a constant zero. Above the maximum pressure of the same, it is 1. In between, it varies, as a linear function of the (effective) control pressure, p_{Ctl} .

The transitions between the regions are sharp and their slopes discontinuous. These pose a challenge to variable-step solvers (the sort commonly used with Simscape models). To precisely capture discontinuities, referred to in some contexts as *zero crossing events*, the solver must reduce its time step, pausing briefly at the time of the crossing in order to recompute its Jacobian matrix (a representation of the dependencies between the state variables of the model and their time derivatives).

This solver strategy is efficient and robust when discontinuities are present. It makes the solver less prone to convergence errors—but it can considerably extend the time needed to finish the simulation

run, perhaps excessively so for practical use in real-time simulation. An alternative approach, used here, is to remove the discontinuities altogether.

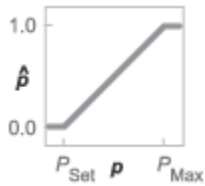

Normalized pressure overshoot with sharp transitions

The block removes the discontinuities by smoothing them over a specified time scale. The smoothing, which adds a slight distortion to the normalized inlet pressure, ensures that the valve eases into its limiting positions rather than snap (abruptly) into them. The smoothing is optional: you can disable it by setting its time scale to zero. The shape and scale of the smoothing, when applied, derives in part from the cubic polynomials:

$$\lambda_L = 3\bar{p}_L^2 - 2\bar{p}_L^3$$

and

$$\lambda_R = 3\bar{p}_R^2 - 2\bar{p}_R^3,$$

where

$$\bar{p}_L = \frac{\hat{p}}{\Delta p^*}$$

and

$$\bar{p}_R = \frac{\hat{p} - (1 - \Delta p^*)}{\Delta p^*}.$$

In the equations:

- λ_L is the smoothing expression for the transition from the maximally closed position.
- λ_R is the smoothing expression for the transition from the fully open position.
- Δp^* is the (unitless) characteristic width of the pressure smoothing region:

$$\Delta p^* = f^* \frac{1}{2},$$

where f^* is a smoothing factor valued between 0 and 1 and obtained from the block parameter of the same name.

When the smoothing factor is 0, the normalized inlet pressure stays in its original form—no smoothing applied—and its transitions remain abrupt. When it is 1, the smoothing spans the whole of the pressure regulation range (with the normalized inlet pressure taking the shape of an S-curve).

At intermediate values, the smoothing is limited to a fraction of that range. A value of 0.5, for example, will smooth the transitions over a quarter of the pressure regulation range on each side (for a total smooth region of half the regulation range).

The smoothing adds two new regions to the normalized pressure overshoot—one for the smooth transition on the left, another for that on the right, giving a total of five regions. These are expressed in the piecewise function:

$$\hat{p}^* = \begin{cases} 0, & \hat{p} \leq 0 \\ \hat{p} \lambda_L, & \hat{p} < \Delta P^* \\ \hat{p}, & \hat{p} \leq 1 - \Delta P^* \\ \hat{p}(1 - \lambda_R) + \lambda_R, & \hat{p} < 1 \\ 1 & \hat{p} \geq 1 \end{cases}$$

where the asterisk denotes a smoothed variable (the normalized control pressure overshoot). The figure shows the effect of smoothing on the sharpness of the transitions.

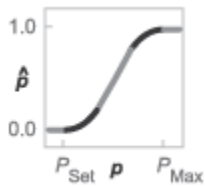

Sonic Conductance

As the normalized control pressure varies during simulation, so does the mass flow rate through the valve. The relationship between the two variables, however, is indirect. The mass flow rate is defined in terms of the valve's sonic conductance and it is this quantity that the normalized inlet pressure determines.

Sonic conductance, if you are unfamiliar with it, describes the ease with which a gas will flow when it is choked—when its velocity is at its theoretical maximum (the local speed of sound). Its measurement and calculation are covered in detail in the ISO 6358 standard (on which this block is based).

Only one value is commonly reported in valve data sheets: one taken at steady state in the fully open position. This is the same specified in the **Sonic conductance at maximum flow** parameter when the **Valve parameterization** setting is Sonic conductance. For values across the opening range of the valve, this maximum is scaled by the normalized pressure overshoot:

$$C = (C_{\text{Max}} - C_{\text{Min}})\hat{p} + C_{\text{Min}}$$

where C is sonic conductance and the subscripts Max and Min denote its values in the fully open and fully closed valve.

Other Parameterizations

Because sonic conductance may not be available (or the most convenient choice for your model), the block provides several equivalent parameterizations. Use the **Valve parameterization** drop-down list to select the best for the data at hand. The parameterizations are:

- Restriction area
- Sonic conductance
- Cv coefficient (USCS)

- K_v coefficient (SI)

The parameterizations differ only in the data that they require of you. Their mass flow rate calculations are still based on sonic conductance. If you select a parameterization other than **Sonic conductance**, then the block converts the alternate data—the (computed) opening area or a (specified) flow coefficient—into an equivalent sonic conductance.

Flow Coefficients

The flow coefficients measure what is, at bottom, the same quantity—the flow rate through the valve at some agreed-upon temperature and pressure differential. They differ only in the standard conditions used in their definition and in the physical units used in their expression:

- C_v is measured at a generally accepted temperature of 60 °F and pressure drop of 1 PSI; it is expressed in imperial units of US gpm. This is the flow coefficient used in the model when the **Valve parameterization** block parameter is set to **Cv coefficient (USCS)**.
- K_v is measured at a generally accepted temperature of 15 °C and pressure drop of 1 bar; it is expressed in metric units of m³/h. This is the flow coefficient used in the model when the **Valve parameterization** block parameter is set to **Kv coefficient (SI)**.

Sonic Conductance Conversions

If the valve parameterization is set to **Cv Coefficient (USCS)**, the sonic conductance is computed at the maximally closed and fully open valve positions from the **Cv coefficient (SI) at maximum flow** and **Cv coefficient (SI) at leakage flow** block parameters:

$$C = (4 \times 10^{-8} C_v) m^3 / (sPa),$$

where C_v is the flow coefficient value at maximum or leakage flow. The subsonic index, m , is set to 0.5 and the critical pressure ratio, b_{cr} , is set to 0.3. (These are used in the mass flow rate calculations given in the “Momentum Balance” on page 1-1150 section.)

If the **Kv coefficient (SI)** parameterization is used instead, the sonic conductance is computed at the same valve positions (maximally closed and fully open) from the **Kv coefficient (USCS) at maximum flow** and **Kv coefficient (USCS) at leakage flow** block parameters:

$$C = (4.758 \times 10^{-8} K_v) m^3 / (sPa),$$

where K_v is the flow coefficient value at maximum or leakage flow. The subsonic index, m , is set to 0.5 and the critical pressure ratio, b_{cr} , is set to 0.3.

For the **Restriction area** parameterization, the sonic conductance is computed (at the same valve positions) from the **Maximum opening area**, and **Leakage area** block parameters:

$$C = (0.128 \times 4S/\pi)L / (sbar),$$

where S is the opening area at maximum or leakage flow. The subsonic index, m , is set to 0.5 while the critical pressure ratio, b_{cr} is computed from the expression:

$$0.41 + 0.272 \left[\frac{\hat{p}(S_{Max} - S_{Leak}) + S_{Leak}}{S} \right]^{0.25}.$$

Momentum Balance

The causes of those pressure losses incurred in the passages of the valve are ignored in the block. Whatever their natures—sudden area changes, flow passage contortions—only their cumulative effect

is considered during simulation. This effect is assumed to reflect entirely in the sonic conductance of the valve (or in the data of the alternate valve parameterizations).

Mass Flow Rate

When the flow is choked, the mass flow rate is a function of the sonic conductance of the valve and of the thermodynamic conditions (pressure and temperature) established at the inlet. The function is linear with respect to pressure:

$$\dot{m}_{\text{ch}} = C\rho_0 p_{\text{in}} \sqrt{\frac{T_0}{T_{\text{in}}}},$$

where:

- C is the sonic conductance inside the valve. Its value is obtained from the block parameter of the same name or by conversion of other block parameters (the exact source depending on the **Valve parameterization** setting).
- ρ is the gas density, here at standard conditions (subscript θ), obtained from the **Reference density** block parameter.
- p is the absolute gas pressure, here corresponding to the inlet (**in**).
- T is the gas temperature at the inlet (**in**) or at standard conditions (θ), the latter obtained from the **Reference temperature** block parameter.

When the flow is subsonic, and therefore no longer choked, the mass flow rate becomes a nonlinear function of pressure—both that at the inlet as well as the reduced value at the outlet. In the turbulent flow regime (with the outlet pressure contained in the back-pressure ratio of the valve), the mass flow rate expression is:

$$\dot{m}_{\text{tur}} = C\rho_0 p_{\text{in}} \sqrt{\frac{T_0}{T_{\text{in}}}} \left[1 - \left(\frac{p_r - b_{\text{cr}}}{1 - b_{\text{cr}}} \right)^2 \right]^m,$$

where:

- p_r is the back-pressure ratio, or that between the outlet pressure (p_{out}) and the inlet pressure (p_{in}):

$$P_r = \frac{p_{\text{out}}}{p_{\text{in}}}$$

- b_{cr} is the critical pressure ratio at which the flow becomes choked. Its value is obtained from the block parameter of the same name or by conversion of other block parameters (the exact source depending on the **Valve parameterization** setting).
- m is the *subsonic index*, an empirical coefficient used to more accurately characterize the behavior of subsonic flows. Its value is obtained from the block parameter of the same name or by conversion of other block parameters (the exact source depending on the **Valve parameterization** setting).

When the flow is laminar (and still subsonic), the mass flow rate expression changes to:

$$\dot{m}_{\text{lam}} = C\rho_0 p_{\text{in}} \left[\frac{1 - p_r}{1 - b_{\text{lam}}} \right] \sqrt{\frac{T_0}{T_{\text{in}}}} \left[1 - \left(\frac{b_{\text{lam}} - b_{\text{cr}}}{1 - b_{\text{cr}}} \right)^2 \right]^m$$

where b_{lam} is the critical pressure ratio at which the flow transitions between laminar and turbulent regimes (obtained from the **Laminar flow pressure ratio** block parameter). Combining the mass flow rate expressions into a single (piecewise) function, gives:

$$\dot{m} = \begin{cases} \dot{m}_{\text{lam}}, & b_{\text{lam}} \leq p_r < 1 \\ \dot{m}_{\text{tur}}, & b_{\text{cr}} \leq p_r < p_{\text{lam}}, \\ \dot{m}_{\text{ch}}, & p_r < b_{\text{Cr}} \end{cases}$$

with the top row corresponding to subsonic and laminar flow, the middle row to subsonic and turbulent flow, and the bottom row to choked (and therefore sonic) flow.

Mass Balance

The volume of fluid inside the valve, and therefore the mass of the same, is assumed to be very small and it is, for modeling purposes, ignored. As a result, no amount of gas can accumulate there. By the principle of conservation of mass, the mass flow rate into the valve through one port must therefore equal that out of the valve through the other port:

$$\dot{m}_A + \dot{m}_B = 0,$$

where \dot{m} is defined as the mass flow rate *into* the valve through port **A** or **B**. Note that in this block the flow can reach but not exceed sonic speeds.

Energy Balance

The valve is modeled as an adiabatic component. No heat exchange can occur between the gas and the wall that surrounds it. No work is done on or by the gas as it traverses from inlet to outlet. With these assumptions, energy can flow by advection only, through ports **A** and **B**. By the principle of conservation of energy, the sum of the port energy flows must then always equal zero:

$$\phi_A + \phi_B = 0,$$

where ϕ is defined as the energy flow rate *into* the valve through one of the ports (**A** or **B**).

Ports

Conserving

A – Valve entrance

gas

Opening through which the working fluid must, during normal operation (when the pilot mechanism is disabled), enter the valve. This port can serve as an exit only when the pilot port is pressurized to a sufficient degree.

B – Valve entrance

gas

Opening through which the working fluid must, during normal operation (when the pilot mechanism is disabled), exit the valve.

X – Pilot port

gas

Opening by which to actuate (by the application of a sufficient pressure) the pilot mechanism that opens the valve for reverse flow.

Parameters

Pressure control specification — Choice of pressure measurement to use as valve control signal

Pressure differential (pX-pA) (default) | Pressure at port X

Choice of pressure measurement to use as valve control signal. The block uses this setting to determine when the valve should begin to open. In the default setting (Pressure differential (pX - pA)), the opening pressure of the valve is expressed as a pressure drop from the pilot port (X) to the inlet (A). In the alternative setting (**Pressure at port X**), it is expressed as a gauge inlet pressure (measured against the environment pressure).

Cracking pressure differential — Effective control pressure at which the valve first opens

0.01 MPa (default) | positive scalar in units of pressure

Effective pressure differential at which the valve begins to open. This differential—the *control pressure* in the block description—is the sum of the pressure drop from inlet to outlet with the product of the pilot pressure and the pilot ratio. (The pilot pressure used depends on the setting of the **Pressure control specification** parameter.)

Maximum opening pressure differential — Effective control pressure at which the valve is fully open

0.02 MPa (default) | positive scalar in units of pressure

Effective pressure differential at which the valve is fully open. This differential—the *control pressure* in the block description—is the sum of the pressure drop from inlet to outlet with the product of the pilot pressure and the pilot ratio. (The pilot pressure used depends on the setting of the **Pressure control specification** parameter.)

Pilot ratio — Ratio of pilot port area to inlet port area

1 (default) | positive unitless scalar

Ratio of the pilot port area to the inlet port area.

Valve parameterization — Method by which to characterize the opening of the valve

Sonic conductance (default) | Cv coefficient (USCS) | Kv coefficient (SI) | Restriction area

Choice of ISO method to use in the calculation of mass flow rate. All calculations are based on the **Sonic conductance** parameterization; if a different option is selected, the data specified in converted into equivalent sonic conductance, critical pressure ratio, and subsonic index. See the block description for more information on the conversion.

This parameter determines which measures of valve opening you must specify—and therefore which of those measures appear as parameters in the block dialog box.

Sonic conductance at maximum flow — Measure of maximum flow rate at reference upstream conditions

1.6 l/s/bar (default) | positive scalar in units of volume/time/pressure

Equivalent measure of the maximum flow rate allowed through the valve at some reference inlet conditions, generally those outlined in ISO 8778. The flow is at a maximum when the valve is fully open and the flow velocity is choked (it being saturated at the local speed of sound). This is the value generally reported by manufacturers in technical data sheets.

Sonic conductance is defined as the ratio of the mass flow rate through the valve to the product of the pressure and density upstream of the valve inlet. This parameter is often referred to in the literature as the *C-value*.

Dependencies

This parameter is active and exposed in the block dialog box when the **Valve parameterization** setting is `Sonic conductance`.

Sonic conductance at leakage flow — Measure of minimum flow rate at reference upstream conditions

1e-5 l/s/bar (default) | positive scalar in units of volume/time/pressure

Equivalent measure of the minimum flow rate allowed through the valve at some reference inlet conditions, generally those outlined in ISO 8778. The flow is at a minimum when the valve is maximally closed and only a small leakage area—due to sealing imperfections, say, or natural valve tolerances—remains between its ports.

Sonic conductance is defined as the ratio of the mass flow rate through the valve to the product of the pressure and density upstream of the valve inlet. This parameter is often referred to in the literature as the *C-value*.

This parameter serves primarily to ensure that closure of the valve does not cause portions of the gas network to become isolated (a condition known to cause problems in simulation). The exact value specified here is less important than its being a (very small) number greater than zero.

Dependencies

This parameter is active and exposed in the block dialog box when the **Valve parameterization** setting is `Sonic conductance`.

Critical pressure ratio — Back-pressure ratio, at reference upstream conditions, at which the flow rate is a maximum

0.3 (default) | positive unitless scalar

Ratio of downstream to upstream absolute pressures at which the flow becomes choked (and its velocity becomes saturated at the local speed of sound). This parameter is often referred to in the literature as the *b-value*. Enter a number greater than or equal to zero and smaller than the **Laminar flow pressure ratio** block parameter.

Dependencies

This parameter is active and exposed in the block dialog box when the **Valve parameterization** setting is `Sonic conductance`.

Subsonic index — Exponent used to more accurately characterize flow in the subsonic regime

0.5 (default) | positive unitless scalar

Empirical exponent used to more accurately calculate the mass flow rate through the valve when the flow is subsonic. This parameter is sometimes referred to as the *m-index*. Its value is approximately 0.5 for valves (and other components) whose flow paths are fixed.

Dependencies

This parameter is active and exposed in the block dialog box when the **Valve parameterization** setting is **Sonic conductance**.

Cv coefficient (USCS) at maximum flow — Flow coefficient of the fully open valve expressed in US customary units

0.4 (default) | positive scalar in units of ft^3/min

Flow coefficient of the fully open valve, expressed in the US customary units of ft^3/min (as described in NFPA T3.21.3). This parameter measures the relative ease with which the gas will traverse the valve when driven by a given pressure differential. This is the value generally reported by manufacturers in technical data sheets.

Dependencies

This parameter is active and exposed in the block dialog box when the **Valve parameterization** setting is **Cv coefficient (USCS)**.

Cv coefficient (USCS) at leakage flow — Flow coefficient of the maximally closed valve expressed in US customary units

$1\text{e}-6$ (default) | positive scalar in units of ft^3/min

Flow coefficient of the maximally closed valve, expressed in the US customary units of ft^3/min (as described in NFPA T3.21.3). This parameter measures the relative ease with which the gas will traverse the valve when driven by a given pressure differential.

The purpose of this parameter is primarily to ensure that closure of the valve does not cause portions of the gas network to become isolated (a condition known to cause problems in simulation). The exact value specified here is less important than its being a (very small) number greater than zero.

Dependencies

This parameter is active and exposed in the block dialog box when the **Valve parameterization** setting is **Cv coefficient (USCS)**.

Kv coefficient (SI) at maximum flow — Flow coefficient of the fully open valve expressed in SI units

0.3 (default) | positive scalar in units of m^3/hr

Flow coefficient of the fully open valve, expressed in the SI units of m^3/hr . This parameter measures the relative ease with which the gas will traverse the valve when driven by a given pressure differential. This is the value generally reported by manufacturers in technical data sheets.

Dependencies

This parameter is active and exposed in the block dialog box when the **Valve parameterization** setting is **Kv coefficient (SI)**.

Kv coefficient (SI) at leakage flow — Flow coefficient of the maximally closed valve expressed in SI units

$1\text{e}-6$ (default) | positive scalar in units of m^3/hr

Flow coefficient of the maximally closed valve, expressed in the SI units of m^3/hr . This parameter measures the relative ease with which the gas will traverse the valve when driven by a given pressure differential.

The purpose of this parameter is primarily to ensure that closure of the valve does not cause portions of the gas network to become isolated (a condition known to cause problems in simulation). The exact value specified here is less important than its being a (very small) number greater than zero.

Dependencies

This parameter is active and exposed in the block dialog box when the **Valve parameterization** setting is **Kv coefficient (SI)**.

Maximum opening area — Opening area in the fully open position due to sealing imperfections

$1\text{e-}4 \text{ m}^2$ (default) | positive scalar in units of area

Opening area of the valve in the fully open position, when the valve is at the upper limit of the pressure regulation range. The block uses this parameter to scale the chosen measure of valve opening—sonic conductance, say, or C_V flow coefficient—throughout the pressure regulation range.

Dependencies

This parameter is active and exposed in the block dialog box when the **Valve parameterization** setting is **Restriction area**.

Leakage area — Opening area in the maximally closed position due to sealing imperfections

$1\text{e-}12 \text{ m}^2$ (default) | positive scalar in units of area

Opening area of the valve in the maximally closed position, when only internal leakage between the ports remains. This parameter serves primarily to ensure that closure of the valve does not cause portions of the gas network to become isolated (a condition known to cause problems in simulation). The exact value specified here is less important than its being a (very small) number greater than zero.

Dependencies

This parameter is active and exposed in the block dialog box when the **Valve parameterization** setting is **Restriction area**.

Cross-sectional area at ports A and B — Area normal to the flow path at the valve ports

0.01 m^2 (default) | positive scalar in units of area

Area normal to the flow path at the valve ports. The ports are assumed to be the same in size. The flow area specified here should ideally match those of the inlets of adjoining components.

Laminar flow pressure ratio — Pressure ratio at which the flow transitions between laminar and turbulent

0.999 (default) | positive unitless scalar

Pressure ratio at which the flow transitions between laminar and turbulent flow regimes. The pressure ratio is the fraction of the absolute pressure downstream of the valve over that just upstream of it. The flow is laminar when the actual pressure ratio is above the threshold specified here and turbulent when it is below. Typical values range from 0.995 to 0.999 .

Reference temperature — ISO 8778 reference temperature

293.15 K (default) | scalar in units of temperature

Temperature at standard reference atmosphere, defined as 293.15 K in ISO 8778.

Reference density — ISO 8778 reference density

1.185 (default) | positive scalar in units of mass/volume

Density at standard reference atmosphere, defined as 1.185 kg/m³ in ISO 8778.

Smoothing factor — Amount of smoothing to apply to the valve opening area function θ (default)

Amount of smoothing to apply to the opening area function of the valve. This parameter determines the widths of the regions to be smoothed—one located at the fully open position, the other at the fully closed position.

The smoothing superposes on each region of the opening area function a nonlinear segment (a third-order polynomial function, from which the smoothing arises). The greater the value specified here, the greater the smoothing is, and the broader the nonlinear segments become.

At the default value of θ , no smoothing is applied. The transitions to the maximally closed and fully open positions then introduce discontinuities (associated with zero-crossings), which tend to slow down the rate of simulation.

Extended Capabilities**C/C++ Code Generation**

Generate C and C++ code using Simulink® Coder™.

See Also

Variable Orifice ISO 6358 (G) | Check Valve (G)

Introduced in R2018b

Pilot Valve Actuator (IL)

Single-acting or double-acting actuator controlled by a pilot pressure in an isothermal liquid network

Library: Simscape / Fluids / Valve Actuators & Forces



Description

The Pilot Valve Actuator (IL) block models a single-acting or double-acting actuator controlled by a pilot pressure for control of a connected valve or orifice in an isothermal liquid network.

For the single-acting actuator, when the control pressure, $P_X - P_{atm}$, exceeds the **Spring preload force at port X**, the piston begins to actuate in the direction assigned by the **Mechanical orientation** parameter.

For the double-acting actuator, the control pressure $P_{control}$ is the difference between $P_X - P_{atm}$ and $P_Y - P_{atm}$. The piston actuates in the direction of the larger applied pressure differential, opposing the spring force at the opposite port. When the piston motion reverses, this spring does not extend and does not exert a counterbalancing force on the piston position.

The pistons at port **X** and port **Y** are attached to a single spool. Both springs restore the spool to its neutral position when F_{spool} falls below the opposing spring preload force. For single-acting actuators, the neutral position is at port **X**. For double-acting actuators, the neutral position is at the center of the actuator.

Single-Acting Actuator

The force on the piston is created by the pressure differential between port **X** and atmospheric pressure:

$$F_{spool} = (p_X - p_{atm})A_X,$$

where A_X is the **Piston area at port X**. When F_{spool} is greater than the **Spring preload force at port X**, the piston begins to move.

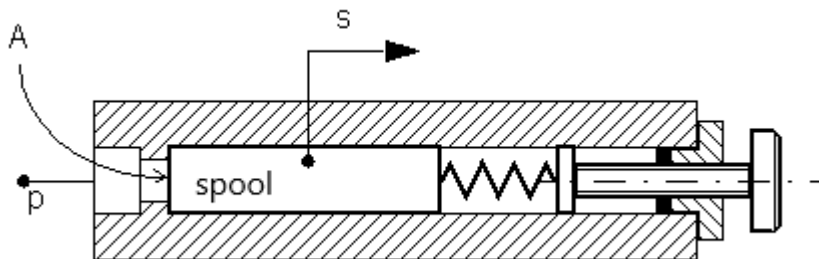

Schematic of a Single-Acting Actuator

Piston Displacement

The instantaneous piston displacement is calculated as:

$$\dot{x}_{dyn} = \frac{x_{steady} - x_{dyn}}{\tau},$$

where the steady piston position, x_{steady} , is the piston position at the current pressure differential, proportional to the spring force at maximum piston stroke:

$$x_{steady} = F_{x_{stroke}} \varepsilon = \frac{F_{spool} - F_{pre}}{F_{max} - F_{pre}} x_{stroke} \varepsilon,$$

where:

- F_{pre} is the **Spring preload force at port X**.
- F_{max} is the maximum spring force acting against piston displacement, $F_{max} = Kx_{stroke} + F_{pre}$, and where K is the **Spring stiffness at port X**.
- x_{stroke} is the **Piston stroke from port X**.
- ε is the **Mechanical orientation**, which indicates piston movement in a positive direction (extension) or negative direction (retraction).

If the force on the piston is less than the **Spring preload force at X**, the piston remains at the neutral position or moves to the neutral position. If the force on the piston meets or exceeds the maximum spring force, the piston remains at the stroke until the applied pressure changes.

Double-Acting Actuator

The difference between the forces at ports **X** and **Y** dictates the piston motion:

$$F_{spool} = (p_X - p_{atm})A_X - (p_Y - p_{atm})A_Y.$$

The pressure applied at port **X** shifts the spool away from the chamber at **X** and opposes the spring at port **Y**. Similarly, the pressure applied at port **Y** shifts the spool away from the chamber at **Y** and opposes the spring at port **X**. When the spool reverses direction, the formerly extended spring compresses, exerting a force on the spool. The formerly compressed spring, the spring at the port in the direction of motion, does not extend and does not influence the spool position.

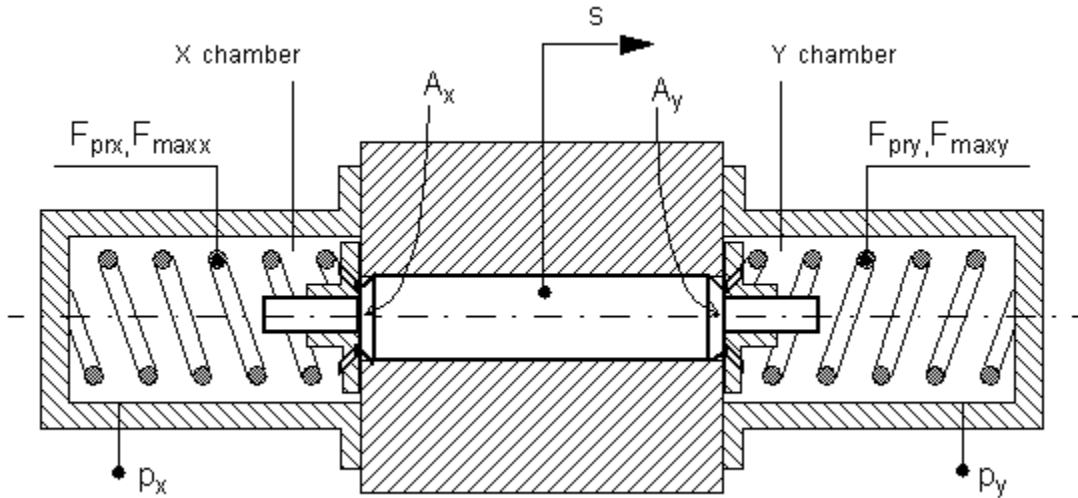

Schematic of a Double-Acting Actuator

Piston Displacement

The piston displacement is calculated as:

$$\dot{x}_{dyn} = \frac{x_{steady} - x_{dyn}}{\tau},$$

where the steady piston position, x_{steady} , is the piston position at the current pressure differential, proportional to the spring force at maximum piston stroke:

$$x_{steady} = (F_Y x_{stroke, Y} - F_X x_{stroke, X}) \varepsilon = \left(\frac{F_{spool} - F_{pre, Y}}{F_{max, Y} - F_{pre, Y}} x_{stroke, Y} - \frac{(-F_{spool} - F_{pre, X})}{F_{max, X} - F_{pre, X}} x_{stroke, X} \right) \varepsilon,$$

where:

- $F_{pre, X}$ and $F_{pre, Y}$ are the **Spring preload force at port X** and **Spring preload force at port Y**, respectively.
- $F_{max, X}$ and $F_{max, Y}$ are the maximum spring forces acting against piston displacement at ports **X** and **Y**, respectively, where:

$$F_{max} = K x_{stroke} + F_{pre},$$

K is the spring stiffness per port.

- x_{stroke} is the piston stroke per port.
- ε is the **Mechanical orientation**, which assigns the signal for piston movement as positive (extension) or negative (retraction).

If the force on the piston is less than the respective port spring preload force, the piston remains or returns to the neutral position. If the force on the piston meets or exceeds the maximum spring force for the respective port, the piston remains at the piston stroke until the applied pressure changes.

Numerically-Smoothed Force

When the actuator is close to full extension or full retraction, you can maintain numerical robustness in your simulation by adjusting the block **Smoothing factor**. With a nonzero smoothing factor, a smoothing function is applied to all calculated forces, but primarily influences the simulation at the extremes of the piston motion.

When **Actuator configuration** is set to Single-acting, the normalized force on the piston is calculated as:

$$\widehat{F}_X = \frac{F_{spool} - F_{Pre}}{F_{max} - F_{Pre}}.$$

When **Actuator configuration** is set to Double-acting, the normalized force on the piston at **X** is calculated as:

$$\widehat{F}_X = \frac{-F_{spool} - F_{Pre,X}}{F_{max,X} - F_{Pre,X}}.$$

and the normalized force at **Y** is calculated as:

$$\widehat{F}_Y = \frac{F_{spool} - F_{Pre,Y}}{F_{max,Y} - F_{Pre,Y}}.$$

When the **Smoothing factor**, s , is nonzero, each normalized force incorporates smoothing:

$$\widehat{F}_{X,smoothed} = \frac{1}{2} + \frac{1}{2} \sqrt{\widehat{F}_X^2 + \left(\frac{s}{4}\right)^2} - \frac{1}{2} \sqrt{(\widehat{F}_X - 1)^2 + \left(\frac{s}{4}\right)^2},$$

$$\widehat{F}_{Y,smoothed} = \frac{1}{2} + \frac{1}{2} \sqrt{\widehat{F}_Y^2 + \left(\frac{s}{4}\right)^2} - \frac{1}{2} \sqrt{(\widehat{F}_Y - 1)^2 + \left(\frac{s}{4}\right)^2}.$$

Ports

Conserving

X — Pressure port P_X

isothermal liquid

Pressure at port **X**. There is no mass flow through the port.

Y — Pressure port P_Y

isothermal liquid

Pressure at port **Y**. There is no mass flow through the port.

Dependencies

To enable this port, set **Actuator type** to Double-acting.

Output

S — Piston displacement, m

physical signal

Piston displacement, specified as a physical signal. The displacement sign corresponds to the direction specified in the **Mechanical orientation** parameter.

Parameters

Actuator configuration — Type of actuator modeled

Single-acting (default) | Double-acting

Type of actuator modeled.

Piston area at port X — Cross-sectional area of piston rod at port X

1e-4 m² (default) | positive scalar

Cross-sectional area of the piston rod at port X.

Piston area at port Y — Cross-sectional area of piston rod at port Y

1e-4 m² (default) | positive scalar

Cross-sectional area of the piston rod at port Y.

Dependencies

To enable this parameter, set **Actuator type** to Double-acting.

Spring preload force — Force in the neutral position

20 N (default) | scalar

Force acting against the piston in the neutral position.

Dependencies

To enable this parameter, set **Actuator type** to Single-acting.

Spring preload force at port X — Force at port X in the neutral position

20 N (default) | scalar

Force at port **X** in the neutral position.

Dependencies

To enable this parameter, set **Actuator type** to Double-acting.

Spring preload force at port Y — Force at port Y in the neutral position

20 N (default) | scalar

Force at port **Y** in the neutral position.

Dependencies

To enable this parameter, set **Actuator type** to Double-acting.

Spring stiffness — Stiffness coefficient

15e3 N/m (default) | positive scalar

Spring stiffness factor. The maximum spring force is determined from the stiffness, K , and the **Spring preload force**: $F_{\max} = Kx_{\text{stroke}} + F_{\text{pre}}$

Dependencies

To enable this parameter, set **Actuator type** to Single-acting.

Spring stiffness at port X — Stiffness coefficient at port X

15e3 N/m (default) | positive scalar

Port **X** spring stiffness. The maximum spring force is determined from the stiffness, K , and the **Spring preload force at port X**: $F_{\max} = Kx_{\text{stroke}} + F_{\text{pre}}$

Dependencies

To enable this parameter, set **Actuator type** to Double-acting.

Spring stiffness at port Y — Stiffness coefficient at port Y

15e3 N/m (default) | positive scalar

Port **Y** spring stiffness. The maximum spring force is determined from the stiffness, K , and the **Spring preload force at port Y**: $F_{\max} = Kx_{\text{stroke}} + F_{\text{pre}}$

Dependencies

To enable this parameter, set **Actuator type** to Double-acting.

Piston stroke — Maximum piston travel distance

5e-3 m (default) | positive scalar

Maximum piston travel distance.

Dependencies

To enable this parameter, set **Actuator type** to Single-acting.

Piston stroke from port X — Maximum piston travel distance at port X

5e-3 m (default) | positive scalar

Maximum piston travel distance at port **X**.

Dependencies

To enable this parameter, set **Actuator type** to Double-acting.

Piston stroke from port Y — Maximum piston travel distance at port Y

5e-3 m (default) | positive scalar

Maximum piston travel distance at port **Y**.

Dependencies

To enable this parameter, set **Actuator type** to Double-acting.

Smoothing factor — Numerical smoothing factor

0.01 (default) | positive scalar in the range [0,1]

Continuous smoothing factor that introduces a layer of gradual change to the flow response when the valve is in near-open or near-closed positions. Set this value to a nonzero value less than one to increase the stability of your simulation in these regimes.

Actuator dynamics – Whether to account for transients during actuation

Off (default) | On

Whether to account for transient effects in the spool position due to actuation. Setting **Actuator dynamics** to On approximates actuator motion by introducing a first-order lag in the spool position. The **Actuator time constant** also impacts the modeled dynamics.

Actuator time constant – Piston displacement time constant

0.1 s (default) | positive scalar

Constant that captures the time required for the piston to reach steady-state when moving from one position to another. This parameter impacts the modeled actuator dynamics.

Dependencies

To enable this parameter, set **Actuator dynamics** to On.

Mechanical orientation – Piston displacement direction

Pilot pressure at port X causes positive piston displacement (default) | Pilot pressure at port X causes negative piston displacement

Sets the piston displacement direction based on the configuration at port **X**. If **Actuator configuration** is set to **Double-acting**, the displacement force at port **Y** acts in the opposite direction of the force at port **X**. Pilot pressure at port X causes positive piston displacement corresponds to positive displacement when the pressure at **X** pushes the piston towards port **Y**. Pilot pressure at port X causes negative piston displacement corresponds to negative displacement when the pressure at **X** pushes the piston towards port **Y**.

See Also

Single-Acting Actuator (IL) | Double-Acting Actuator (IL) | Pilot-Operated Check Valve (IL) | Cartridge Valve Actuator (IL)

Introduced in R2020a

Pipe Bend

Hydraulic resistance in pipe bend



Library

Local Hydraulic Resistances

Description

The Pipe Bend block represents a pipe bend as a local hydraulic resistance. The pressure loss in the bend is assumed to consist of

- Loss in the straight pipe
- Loss due to curvature

The loss in a straight pipe is simulated with the Hydraulic Resistive Tube block. The loss due to curvature is simulated with the Local Resistance block, and the pressure loss coefficient is determined in accordance with the Crane Co. recommendations (see [1] on page 1-1169, p. A-29). The flow regime is checked in the underlying Local Resistance block by comparing the Reynolds number to the specified critical Reynolds number value.

The pressure loss due to curvature for turbulent flow regime is determined according to the following formula:

$$p = K \frac{\rho}{2A^2} q |q|$$

where

q	Flow rate
p	Pressure loss
K	Pressure loss coefficient
A	Bend cross-sectional area
ρ	Fluid density

For laminar flow regime, the formula for pressure loss computation is modified, as described in the reference documentation for the Local Resistance block.

The pressure loss coefficient is determined according to recommendation provided in [1] on page 1-1169:

$$K = K_d \cdot K_r \cdot K_\alpha$$

where

K_d	Base friction factor coefficient
K_r	Correction coefficient accounting for the bend curvature
K_α	Correction coefficient accounting for the bend angle

The base friction factor coefficient is determined according to the following table.

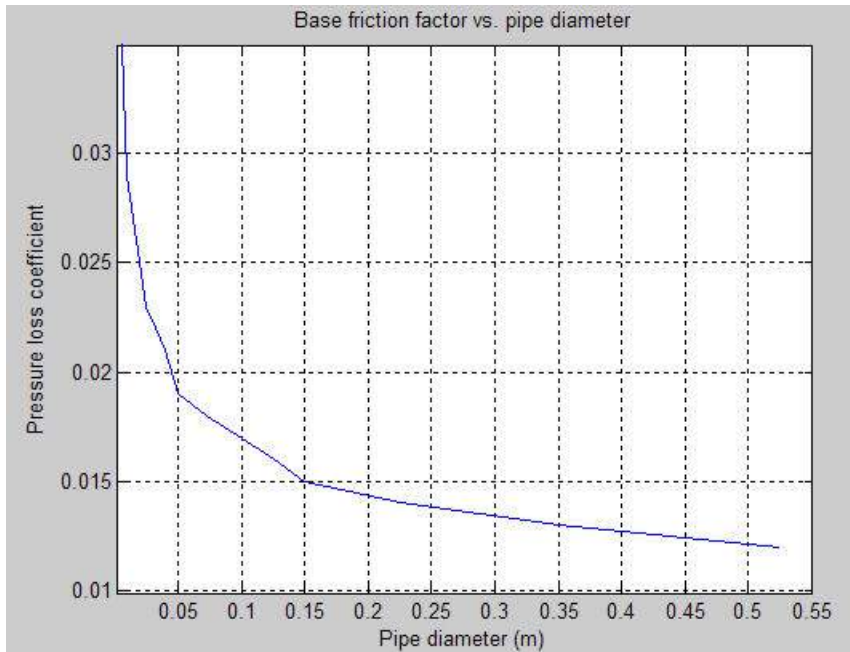

Note Friction factors for pipes with diameters greater than 525 mm are determined by extrapolation.

The correction coefficient accounting for the bend curvature is determined according to the next table.

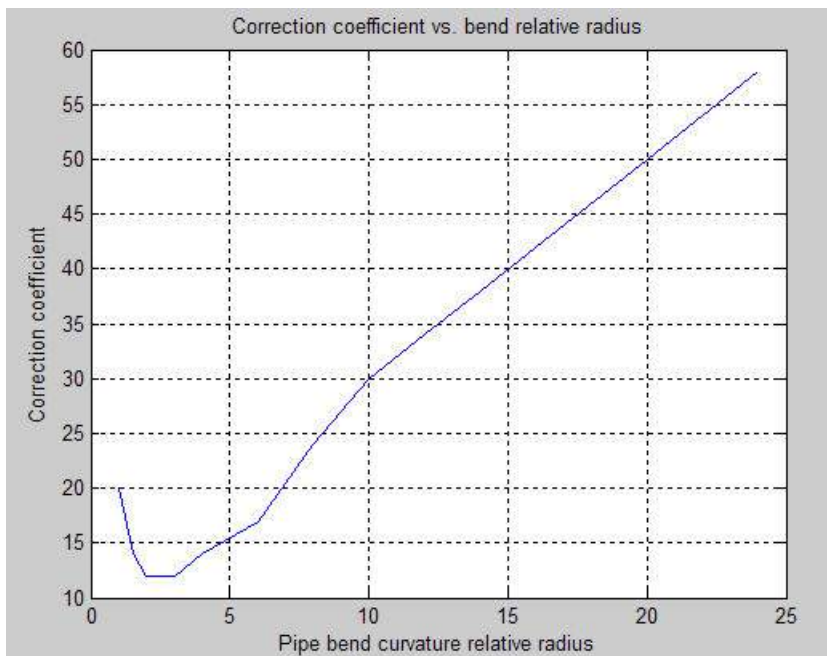

The bend curvature relative radius is calculated as

$$r = \text{bend radius} / \text{pipe diameter}$$

Note For pipes with the bend curvature relative radius value outside the range of $1 > r > 24$, correction coefficients are determined by extrapolation.

Correction for non-90° bends is performed with the empirical formula (see [2] on page 1-1169, Fig. 4.6):

$$K_{\alpha} = \alpha(0.0142 - 3.703 \cdot 10^{-5} \alpha)$$

where

α	Bend angle in degrees ($0 \leq \alpha \leq 180$)
----------	--

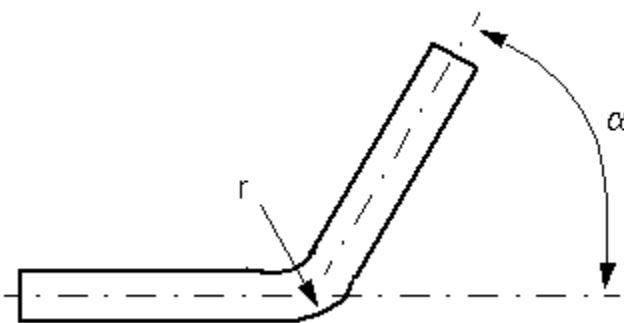

Connections A and B are conserving hydraulic ports associated with the block inlet and outlet, respectively.

The block positive direction is from port A to port B. This means that the flow rate is positive if fluid flows from A to B, and the pressure differential is determined as $p = p_A - p_B$.

Warning The formulas used in the Pipe Bend block are very approximate, especially in the laminar and transient flow regions. For more accurate results, use a combination of the Local Resistance block with a table-specified $K=f(Re)$ relationship and the Hydraulic Resistive Tube block.

Basic Assumptions and Limitations

- Fluid inertia and wall compliance are not taken into account.
- The bend is assumed to be made of a clean commercial steel pipe.

Parameters

Pipe diameter

The internal diameter of the pipe. The default value is 0.01 m.

Bend radius

The radius of the bend. The default value is 0.04 m.

Bend angle

The angle of the bend. The value must be in the range between 0 and 180 degrees. The default value is 90 deg.

Internal surface roughness height

Roughness height on the pipe internal surface. The parameter is typically provided in data sheets or manufacturer's catalogs. The default value is 1.5e-5 m, which corresponds to drawn tubing.

Critical Reynolds number

The maximum Reynolds number for laminar flow. The value of the parameter depends on the orifice geometrical profile. You can find recommendations on the parameter value in hydraulics textbooks. The default value is 350.

Fluid compressibility

Dynamic compressibility setting. Select **On** to make the fluid density dependent on pressure and temperature. Select **Off** to treat the fluid density as a constant. Dynamic compressibility impacts the transient response of the fluid at small time scales and can slow down simulation.

Initial liquid pressure (gauge)

Gauge pressure in the pipe bend at time zero. The default value is 0 Pa.

Global Parameters

Parameters determined by the type of working fluid:

- **Fluid density**
- **Fluid kinematic viscosity**

Use the Hydraulic Fluid block or the Custom Hydraulic Fluid block to specify the fluid properties.

Ports

The block has the following ports:

A

Hydraulic conserving port associated with the bend inlet.

B

Hydraulic conserving port associated with the bend outlet.

References

[1] *Flow of Fluids Through Valves, Fittings, and Pipe*, Crane Valves North America, Technical Paper No. 410M

[2] George R. Keller, *Hydraulic System Analysis*, Published by the Editors of Hydraulics & Pneumatics Magazine, 1970

Extended Capabilities

C/C++ Code Generation

Generate C and C++ code using Simulink® Coder™.

See Also

Elbow | Gradual Area Change | Local Resistance | Hydraulic Resistive Tube | Sudden Area Change | T-junction

Topics

“Upgrading Simscape Fluids Models Containing Hydraulics (Isothermal) Blocks”

Introduced in R2006b

Pipe Bend (IL)

Pipe bend segment in an isothermal liquid network

Library: Simscape / Fluids / Isothermal Liquid / Pipes & Fittings



Description

The Pipe Bend (IL) block models a curved pipe in an isothermal liquid network. You can define the pipe characteristics to calculate losses due to friction and pipe curvature and optionally model fluid compressibility.

Pipe Curvature Loss Coefficient

The coefficient for pressure losses due to geometry changes comprises an angle correction factor, C_{angle} , and a bend coefficient, C_{bend} :

$$K_{loss} = C_{angle}C_{bend}.$$

C_{angle} is calculated as:

$$C_{angle} = 0.0148\theta - 3.9716 \cdot 10^{-5}\theta^2,$$

where θ is the **Bend angle**, in degrees.

C_{bend} is calculated from the tabulated ratio of bend radius to pipe diameter for 90° bends from Crane [1]:

**90° PIPE BENDS AND
FLANGED OR BUTT-WELDING 90° ELBOWS**

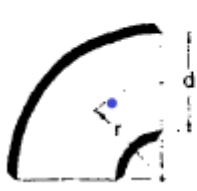

r/d	K	r/d	K
1	$20 f_T$	8	$24 f_T$
1.5	$14 f_T$	10	$30 f_T$
2	$12 f_T$	12	$34 f_T$
3	$12 f_T$	14	$38 f_T$
4	$14 f_T$	16	$42 f_T$
6	$17 f_T$	20	$50 f_T$

The friction factor, f_T , for clean commercial steel is interpolated from tabular data based on pipe diameter [1]:

**PIPE FRICTION DATA FOR CLEAN COMMERCIAL STEEL PIPE
WITH FLOW IN ZONE OF COMPLETE TURBULENCE**

Nominal Size	1/2"	3/4"	1"	1 1/4"	1 1/2"	2"	2 1/2, 3"	4"	5"	6"	8-10"	12-16"	18-24"
Friction Factor (f_f)	.027	.025	.023	.022	.021	.019	.018	.017	.016	.015	.014	.013	.012

Note that the correction factor is valid for a ratio of bend radius to diameter between 1 and 24. Beyond this range, nearest-neighbor extrapolation is employed.

Losses Due to Friction in Laminar Flows

The pressure loss formulations are the same for the flow at ports **A** and **B**.

When the flow in the pipe is fully laminar, or below $Re = 2000$, the pressure loss over the bend is:

$$\Delta p_{loss} = \frac{\mu \lambda}{2 \rho_I d^2 A} \frac{L}{2} \dot{m}_{port}$$

where:

- μ is the fluid dynamic viscosity.
- λ is the Darcy friction factor constant, which is 64 for laminar flow.
- ρ_I is the internal fluid density.
- d is the pipe diameter.
- L is the bend length segment, the product of the **Bend radius** and the **Bend angle**:
 $L_{bend} = r_{bend} \theta$..
- A is the pipe cross-sectional area, $\frac{\pi}{4} d^2$.
- \dot{m}_{port} is the mass flow rate at the respective port.

Losses due to Friction in Turbulent Flows

When the flow is fully turbulent, or greater than $Re = 4000$, the pressure loss in the pipe is:

$$\Delta p_{loss} = \left(\frac{f_D L}{2d} + \frac{K_{loss}}{2} \right) \frac{\dot{m}_{port} |\dot{m}_{port}|}{2 \rho_I A^2}$$

where f_D is the Darcy friction factor. This is approximated by the empirical Haaland equation and is based on the **Internal surface absolute roughness**. The differential is taken over half of the pipe segment, between port **A** to an internal node, and between the internal node and port **B**.

Pressure Differential for Incompressible Fluids

When the flow is incompressible, the pressure loss over the bend is:

$$p_A - p_B = \Delta p_{loss, A} - \Delta p_{loss, B}$$

Pressure Differential for Compressible Fluids

When the flow is compressible, the pressure loss over the bend is calculated based on the internal fluid volume pressure, p_I :

$$p_A - p_I = \Delta p_{loss, A}$$

$$p_B - p_I = \Delta p_{loss, B}$$

Mass Conservation

For an incompressible fluid, the mass flow into the pipe equals the mass flow out of the pipe:

$$\dot{m}_A + \dot{m}_B = 0.$$

When the fluid is compressible, the difference between the mass flow into and out of the pipe depends on the fluid density change due to compressibility:

$$\dot{m}_A + \dot{m}_B = \dot{p}_I \frac{d\rho_I}{dp_I} V,$$

where V is the product of the pipe cross-sectional area and bend length, AL .

Ports

Conserving

A — Liquid port

isothermal liquid

Liquid entry or exit port.

B — Liquid port

isothermal liquid

Liquid entry or exit port.

Parameters

Pipe diameter — Pipe diameter

0.01 m (default) | positive scalar

Diameter of the pipe.

Bend radius — Bend circle radius

0.04 m (default) | positive scalar

Radius of the circle formed by the pipe bend.

Bend angle — Bend angle

90 deg (default) | positive scalar

Swept degree of the pipe bend.

Internal surface absolute roughness – Pipe wall roughness

15e-6 m (default) | positive scalar

Pipe wall absolute roughness. This parameter is used to determine the Darcy friction factor, which contributes to pressure loss in the pipe.

Fluid dynamic compressibility – Whether to model fluid compressibility

Off (default) | On

Whether to model any change in fluid mass due to fluid compressibility. When **Fluid compressibility** is set to On, mass changes due to varying fluid density in the segment are calculated. The fluid volume in the pipe remains constant. In the Isothermal Liquid library, all blocks calculate density as a function of pressure.

Initial liquid pressure – Pipe pressure at beginning of simulation

0.101325 MPa (default) | positive scalar

Pipe pressure at the beginning of the simulation.

Dependencies

To enable this parameter, set **Fluid dynamic compressibility** to On.

References

[1] Crane Co. *Flow of Fluids Through Valves, Fittings, and Pipe TP-410*. Crane Co., 1981.

See Also

Elbow (IL) | T-Junction (IL) | Local Resistance (IL) | Area Change (IL) | Pipe (IL) | Partially Filled Pipe (IL)

Introduced in R2020a

Pipe (TL)

Closed conduit for the transport of fluid between thermal liquid components

Library: Simscape / Fluids / Thermal Liquid / Pipes & Fittings



Description

The Pipe (TL) block models thermal liquid flow through a pipe. The temperature across the pipe is calculated from the temperature differential between ports, pipe elevation, and any additional heat transfer at port **H**.

The pipe can have a constant or varying elevation between ports **A** and **B**. For a constant elevation differential, use the **Elevation gain from port A to port B** parameter. You can specify a variable elevation by setting **Elevation gain specification** to **Variable**. This exposes physical signal port **EL**.

You can optionally model fluid dynamic compressibility, inertia, and wall flexibility. When these phenomena are modeled, the flow properties are calculated for each number of pipe segments that you specify.



Pipe Flexibility

Flexible walls are modeled by a uniform radial expansion that maintains the original pipe cross-sectional shape. You can specify the pipe area in the **Nominal cross-sectional area** parameter, meaning that there is no specified cross-sectional geometry modeled by the block. However, the block uses the pipe hydraulic diameter in heat transfer and pressure loss calculations.

The deformation of the pipe diameter is calculated as:

$$\dot{D} = \frac{D_S - D}{\tau},$$

where:

- D_S is the post-deformation, steady-state pipe diameter,

$$D_S = D_N + K_C(p - p_{atm}),$$

where K_c is the **Static pressure-diameter compliance**, p is the tube pressure, and p_{atm} is the atmospheric pressure. Assuming elastic deformation of a thin-walled, open-ended pipe, you can calculate K_c as:

$$K_c = \frac{D^2}{2tE},$$

where t is the pipe wall thickness and E is Young's modulus.

- D_N is the nominal pipe diameter, or the diameter previous to deformation:

$$D_N = \sqrt{\frac{4S}{\pi}},$$

where S is the **Nominal cross-sectional area** of the pipe.

- D is the pipe **Hydraulic diameter**.
- τ is the **Viscoelastic pressure time constant**.

Heat Transfer at the Pipe Wall

You can model heat transfer to and from the pipe walls in multiple ways. There are two analytical models: the Gnielinski correlation, which models the Nusselt number as a function of the Reynolds and Prandtl numbers with predefined coefficients, and the Dittus-Boelter correlation - $Nusselt = a \cdot Re^b \cdot Pr^c$, which models the Nusselt number as a function of the Reynolds and Prandtl numbers with user-defined coefficients.

The Nominal temperature differential vs. nominal mass flow rate, Tabulated data - Colburn factor vs. Reynolds number, and Tabulated data - Nusselt number vs. Reynolds number & Prandtl number are look-up table parameterizations based on user-supplied data.

Heat transfer between the fluid and pipe wall occurs through convection, Q_{Conv} and conduction, Q_{Cond} .

Heat transfer due to conduction is:

$$Q_{Cond} = \frac{k_I S_H}{D} (T_H - T_I),$$

where:

- D is the **Hydraulic diameter** if the pipe walls are rigid, and is the pipe steady-state diameter, D_S , if the pipe walls are flexible.
- k_I is the thermal conductivity of the thermal liquid, defined internally for each pipe segment.
- S_H is the surface area of the pipe wall.
- T_H is the pipe wall temperature.
- T_I is the fluid temperature, taken at the pipe internal node.

Heat transfer due to convection is:

$$Q_{Conv} = c_{p,Avg} |\dot{m}_{Avg}| (T_H - T_{In}) \left[1 - \exp\left(-\frac{h S_H}{c_{p,Avg} |\dot{m}_{Avg}|}\right) \right],$$

where:

- $c_{p, Avg}$ is the average fluid specific heat.
- \dot{m}_{Avg} is the average mass flow rate through the pipe.
- T_{In} is the fluid inlet port temperature.
- h is the pipe heat transfer coefficient.

The heat transfer coefficient h is:

$$h = \frac{Nu k_{Avg}}{D},$$

except when parameterizing by **Nominal temperature differential vs. nominal mass flow rate**, where k_{Avg} is the average thermal conductivity of the thermal liquid over the entire pipe and Nu is the average Nusselt number in the pipe.

Analytical Parameterizations

When **Heat transfer parameterization** is set to **Gnielinski correlation** and the flow is turbulent, the average Nusselt number is calculated as:

$$Nu = \frac{f/8(Re-1000)Pr}{1 + 12.7(f/8)^{1/2}(Pr^{2/3} - 1)},$$

where:

- f is the average Darcy friction factor, according to the Haaland correlation:

$$f = \left\{ -1.8 \log_{10} \left[\frac{6.9}{Re} + \left(\frac{\epsilon_R}{3.7D} \right)^{1.11} \right] \right\}^{-2},$$

where ϵ_R is the pipe **Internal surface absolute roughness**.

- Re is the Reynolds number.
- Pr is the Prandtl number.

When the flow is laminar, the Nusselt number is the **Nusselt number for laminar flow heat transfer** parameter.

When **Heat transfer parameterization** is set to **Dittus-Boelter correlation** and the flow is turbulent, the average Nusselt number is calculated as:

$$Nu = a Re^b Pr^c,$$

where:

- a is the value of the **Coefficient a** parameter.
- b is the value of the **Exponent b** parameter.
- c is the value of the **Exponent c** parameter.

The block default Dittus-Boelter correlation is:

$$Nu = 0.023 Re^{0.8} Pr^{0.4}.$$

When the flow is laminar, the Nusselt number is the **Nusselt number for laminar flow heat transfer** parameter.

Parameterization By Tabulated Data

When **Heat transfer parameterization** is set to Tabulated data - Colburn factor vs. Reynolds number, the average Nusselt number is calculated as:

$$\text{Nu} = J_M(\text{Re})\text{RePr}^{1/3}.$$

where J_M is the Colburn-Chilton factor.

When **Heat transfer parameterization** is set to Tabulated data - Nusselt number vs. Reynolds number & Prandtl number, the Nusselt number is interpolated from the three-dimensional array of average Nusselt number as a function of both average Reynolds number and average Prandtl number:

$$\text{Nu} = \text{Nu}(\text{Re}, \text{Pr}).$$

When **Heat transfer parameterization** is set to Nominal temperature difference vs. nominal mass flow rate and the flow is turbulent, the heat transfer coefficient is calculated as:

$$h = \frac{h_N D_N^{1.8} \dot{m}_{\text{Avg}}^{0.8}}{\dot{m}_N^{0.8} D^{1.8}},$$

where:

- \dot{m}_N is the **Nominal mass flow rate**.
- \dot{m}_{Avg} is the average mass flow rate:

$$\dot{m}_{\text{Avg}} = \frac{\dot{m}_A - \dot{m}_B}{2}.$$

- h_N is the nominal heat transfer coefficient, which is calculated as:

$$h_N = \frac{\dot{m}_N c_{p,N}}{S_{H,N}} \ln \left(\frac{T_{H,N} - T_{\text{In},N}}{T_{H,N} - T_{\text{Out},N}} \right),$$

where:

- $S_{H,N}$ is the nominal wall surface area.
- $T_{H,N}$ is the **Nominal wall temperature**.
- $T_{\text{In},N}$ is the **Nominal inflow temperature**.
- $T_{\text{Out},N}$ is the **Nominal outflow temperature**.

This relationship is based on the assumption that the Nusselt number is proportional to the Reynolds number:

$$\frac{hD}{k} \propto \left(\frac{\dot{m}D}{S\mu} \right)^{0.8}.$$

If the pipe walls are rigid, the expression for the heat transfer coefficient becomes:

$$h = \frac{h_N}{\dot{m}_N^{0.8}} \dot{m}_{\text{Avg}}^{0.8}.$$

Pressure Losses Due to Viscous Friction

There are multiple ways to model the pressure differential over the pipe. The **Haaland correlation** provides an analytical model for flows through circular pipes with a Darcy friction factor. The **Nominal pressure drop vs. nominal mass flow rate** and the **Tabulated data - Darcy friction factor vs. Reynolds number** parameterizations allow you to provide data that the block will use as a look-up table during simulation.

Analytical parameterization

When **Viscous friction parameterization** is set to **Haaland correlation** and the flow is turbulent, the pressure loss due to friction at pipe walls is determined by the Darcy-Weisbach equation:

$$p_A - p_I = f \frac{\dot{m}_A |\dot{m}_A|}{2\rho_l D S^2} \left(\frac{L + L_{Add}}{2} \right),$$

where:

- L is the **Pipe length**.
- L_E is the **Aggregate equivalent length of local resistances**, which is the equivalent length of a tube that introduces the same amount of loss as the sum of the losses due to other local resistances in the tube.

The pressure differential between port **B** and internal node I is:

$$p_B - p_I = f \frac{\dot{m}_B |\dot{m}_B|}{2\rho_l D S^2} \left(\frac{L + L_{Add}}{2} \right),$$

When the flow is laminar, the pressure loss due to friction is calculated in terms of the **Laminar friction constant for Darcy friction factor**, λ . The pressure differential between port **A** and internal node I is:

$$p_A - p_I = \frac{\lambda \mu \dot{m}_A}{2\rho D^2 S} \left(\frac{L + L_{Add}}{2} \right).$$

The pressure differential between port **B** and internal node I is:

$$p_B - p_I = \frac{\lambda \mu \dot{m}_B}{2\rho D^2 S} \left(\frac{L + L_{Add}}{2} \right).$$

For transitional flows, the pressure differential due to viscous friction is a smoothed blend between the values for laminar and turbulent pressure losses.

Parameterization by Tabulated Data

When **Viscous friction parameterization** is set to **Nominal pressure drop vs. nominal mass flow rate**, the pressure loss due to viscous friction is calculated over the two pipe halves with the loss coefficient K_p :

$$\Delta p_{f,A} = \frac{1}{2} K_p \dot{m}_A \sqrt{\dot{m}_A^2 + \dot{m}_{Th}^2}$$

$$\Delta p_{f,B} = \frac{1}{2} K_p \dot{m}_B \sqrt{\dot{m}_B^2 + \dot{m}_{Th}^2}$$

where:

- \dot{m}_{Th} is the **Mass flow rate threshold for flow reversal**.
- K_p is a pressure loss coefficient. For flexible pipe walls, the pressure loss coefficient is:

$$K_p = \frac{p_N}{\dot{m}_N^2} D_N,$$

where:

- p_N is the **Nominal pressure drop**.
- \dot{m}_N is the **Nominal mass flow rate**.

The pressure loss coefficient is

$$K_p = \frac{p_N}{\dot{m}_N^2},$$

when the pipe walls are rigid. When the **Nominal pressure drop** and **Nominal mass flow rate** parameters are vectors, the value of K_p is determined as a least-squares fit of the vector elements.

When the

When **Viscous friction parameterization** is set to **Tabulated data – Darcy friction factor vs. Reynolds number**, the friction factor is interpolated from the tabulated data as a function of the Reynolds number:

$$f = f(\text{Re}).$$

Momentum Balance

The pressure differential over the pipe is due to the pressure at the pipe ports, friction at the pipe walls, and hydrostatic changes due to any change in elevation:

$$p_A - p_B = \Delta p_f + \rho_I g \Delta z,$$

where:

- p_A is the pressure at a port **A**.
- p_B is the pressure at a port **B**.
- Δp_f is the pressure differential due to viscous friction, $\Delta p_{f,A} + \Delta p_{f,B}$.
- g is **Gravitational acceleration**.
- Δz the elevation differential between port **A** and port **B**, or $z_A - z_B$.
- ρ_I is the internal fluid density, which is measured at each pipe segment. If fluid dynamic compressibility is not modeled, this is:

$$\rho_I = \frac{p_A + p_B}{2}.$$

When fluid inertia is not modeled, the momentum balance between port **A** and internal node I is:

$$p_A - p_I = \Delta p_{f,A} + \rho_1 g \frac{\Delta z}{2}.$$

When fluid inertia is not modeled, the momentum balance between port **B** and internal node I is:

$$p_B - p_I = \Delta p_{f,B} - \rho_1 g \frac{\Delta z}{2}.$$

When fluid inertia is modeled, the momentum balance between port **A** and internal node I is:

$$p_A - p_I = \Delta p_{f,A} + \rho_1 g \frac{\Delta z}{2} + \frac{\ddot{m}_A L}{S},$$

where:

- \ddot{m}_A is the fluid inertia at port **A**.
- L is the **Pipe length**.
- S is the **Nominal cross-sectional area**.

When fluid inertia is modeled, the momentum balance between port **B** and internal node I is:

$$p_B - p_I = \Delta p_{f,B} - \rho_1 g \frac{\Delta z}{2} + \frac{\ddot{m}_B L}{S},$$

where

\ddot{m}_B is the fluid inertia at port **B**.

Pipe Discretization

You can divide the pipe into multiple segments. If a pipe has more than one segment, the mass flow, energy flow, and momentum balance equations are calculated for each segment. Having multiple pipe segments can allow you to track changes to variables such as fluid density when fluid dynamic compressibility is modeled.

If you would like to capture specific phenomena in your application, such as water hammer, choose a number of segments that provides sufficient resolution of the transient. The following formula, from the Nyquist sampling theorem, provides a rule of thumb for pipe discretization into a minimum of N segments:

$$N = 2L \frac{f}{c},$$

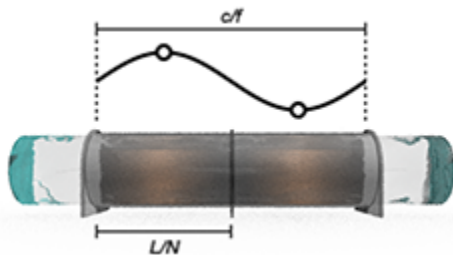

where:

- L is the **Pipe length**.
- f is the transient frequency.
- c is the speed of sound.

In some cases, such as modeling thermal transients along a pipe, it may be better suited to your application to connect multiple Pipe (TL) blocks in series.

Mass Balance

For a rigid pipe with an incompressible fluid, the pipe mass conservation equation is:

$$\dot{m}_A + \dot{m}_B = 0,$$

where:

- \dot{m}_A is the mass flow rate at port **A**.
- \dot{m}_B is the mass flow rate at port **B**.

For a flexible pipe with an incompressible fluid, the pipe mass conservation equation is:

$$\dot{m}_A + \dot{m}_B = \rho_I \dot{V},$$

where:

- ρ_I is the thermal liquid density at internal node I. Each pipe segment has an internal node.
- \dot{V} is the rate of deformation of the pipe volume.

For a flexible pipe with a compressible fluid, the pipe mass conservation equation is: This dependence is captured by the bulk modulus and thermal expansion coefficient of the thermal liquid:

$$\dot{m}_A + \dot{m}_B = \rho_I \dot{V} + \rho_I V \left(\frac{\dot{p}_I}{\beta_I} - \alpha_I \dot{T}_I \right),$$

where:

- p_I is the thermal liquid pressure at the internal node I.
- \dot{T}_I is the rate of change of the thermal liquid temperature at the internal node I.
- β_I is the thermal liquid bulk modulus.
- α is the liquid thermal expansion coefficient.

Energy Balance

The energy accumulation rate in the pipe at internal node I is defined as:

$$\dot{E} = \phi_A + \phi_B + \phi_H - \dot{m}_{Avg} g \Delta z,$$

where:

- ϕ_A is the energy flow rate at port **A**.
- ϕ_B is the energy flow rate at port **B**.
- ϕ_H is the energy flow rate at port **H**.

The total energy is defined as:

$$E = \rho_I u_I V,$$

where:

- u_I is the fluid specific internal energy at node I.
- V is the pipe volume.

If the fluid is compressible, the expression for energy accumulation rate is:

$$\dot{E} = \rho_I V \left(\frac{du}{dp} \frac{dp}{dt} + \frac{du}{dT} \frac{dT}{dt} \right)_I.$$

If the fluid is compressible and the pipe walls are flexible, the expression for energy accumulation rate is:

$$\dot{E} = \rho_I V \left(\frac{du}{dp} \frac{dp}{dt} + \frac{du}{dT} \frac{dT}{dt} \right)_I + (\rho_I u_I + p_I) \left(\frac{dV}{dt} \right)_I.$$

Ports

Input

EL — Port elevation difference

physical signal

Variable elevation differential between port **A** and **B**, specified as a physical signal.

Conserving

A — Pipe opening

thermal liquid

Liquid entry or exit port to the pipe.

B — Pipe opening

thermal liquid

Liquid entry or exit port to the pipe.

H — Pipe wall

thermal

Pipe wall temperature.

Parameters

Configuration

Fluid dynamic compressibility — Whether to model fluid dynamic compressibility

On (default) | Off

Whether to model any change in fluid density due to fluid compressibility. When **Fluid compressibility** is set to On, changes due to the mass flow rate into the block are calculated in addition to density changes due to changes in pressure.

Fluid inertia — Whether to model fluid acceleration

On (default) | Off

Whether to account for acceleration in the mass flow rate due to the mass of the fluid.

Dependencies

To enable this parameter, set **Fluid dynamic compressibility** to On.

Number of segments — Pipe discretization

1 (default) | positive unitless scalar

Number of pipe divisions. Each division represents an individual segment over which pressure is calculated, depending on the pipe inlet pressure, fluid compressibility, and wall flexibility, if applicable. The fluid volume in each segment remains fixed.

Dependencies

To enable this parameter, set **Fluid dynamic compressibility** to On.

Pipe total length — Total pipe length

5 m (default) | positive scalar in units of length

Total pipe length across all pipe segments.

Nominal cross-sectional area — Cross-sectional pipe area without deformation0.01 m² (default) | positive scalar in units of area

Cross-sectional area of the pipe without deformations.

Pipe wall specification — Specifies wall flexibility

Rigid (default) | Flexible

Specifies pipe walls as rigid or flexible. Flexible walls are modeled by a uniform radial expansion that maintains the original pipe cross-sectional shape.

Dependencies

To enable this parameter, set **Fluid dynamic compressibility** to On.

Hydraulic diameter — Effective diameter of noncircular pipes

0.1128 m (default) | positive scalar in units of length

Effective diameter used in heat transfer, momentum balance, and pipe flexibility equations. For noncircular pipes, the hydraulic diameter is the effective diameter of the fluid in the pipe. For circular pipes, the hydraulic diameter and pipe diameter are the same.

Dependencies

To enable this parameter, set either:

- **Fluid dynamic compressibility** to Off.
- **Pipe wall specification** to Rigid and **Fluid dynamic compressibility** to On.

Elevation gain specification — Set pipe elevation property

Constant (default) | Variable

Set the pipe elevation as either Constant or Variable. Selecting Variable exposes the physical signal port **EL**.

Elevation gain from port A to port B — Change in elevation from port A to port B

0 m (default) | positive scalar in units of length

Elevation differential for constant-elevation pipes. The elevation gain must be less than or equal to the **Pipe total length**.

Dependencies

To enable this parameter, set **Elevation gain specification** to Constant.

Gravitational acceleration — Acceleration due to gravity at mean pipe elevation

9.81 m/s² (default) | positive scalar in units of length/time²

Constant of the gravitational acceleration (*g*) at the mean elevation of the pipe.

Static pressure-diameter compliance — Measure of pipe deformation

1.2e-6 m/MPa (default) | positive scalar in units of length/pressure

Coefficient of pipe radial deformation due to changes in pressure. This is a material property of the pipe.

Dependencies

To enable this parameter, set **Pipe wall specification** to Flexible.

Viscoelastic process time constant — Pipe deformation time constant

0.01 s (default) | positive scalar in units of time

Time required for the wall to reach steady-state after pipe deformation. This parameter impacts the dynamic change in pipe volume.

Dependencies

To enable this parameter, set **Pipe wall specification** to Flexible.

Viscous Friction

Viscous friction parameterization — Friction model

Haaland correlation (default) | Nominal pressure drop vs. nominal mass flow rate |
Tabulated data - Darcy friction factor vs. Reynolds number

Parameterization of pressure losses due to wall friction. Both analytical and tabular formulations are available.

Aggregate equivalent length of local resistances — Minor pressure loss in the pipe expressed as a length

1 m (default) | positive scalar in units of length

Length of pipe that would produce the equivalent hydraulic losses as would a pipe with bends, area changes, or other nonuniformities. The effective length of the pipe is the sum of the **Pipe length** and the **Aggregate equivalent length of local resistances**.

Dependencies

To enable this parameter, set **Viscous friction parameterization** to Haaland correlation.

Internal surface absolute roughness — Pipe wall absolute roughness

1.5e-5 m (default) | positive scalar in units of length

Pipe wall absolute roughness. This parameter is used to determine the Darcy friction factor, which contributes to pressure loss in the pipe.

Dependencies

To enable this parameter, set **Viscous friction parameterization** to Haaland correlation.

Shape factor for laminar flow viscous friction — Friction constant for laminar flows

64 (default) | positive unitless scalar

Friction constant for laminar flows. The Darcy friction factor captures the contribution of wall friction in pressure loss calculations.

Laminar flow upper Reynolds number limit — Reynolds number below which the flow is laminar

2e+3 (default) | positive unitless scalar

Reynolds number below which the flow is laminar. Above this threshold, the flow transitions to turbulent, reaching the turbulent regime at the **Turbulent flow lower Reynolds number limit** setting.

Turbulent flow lower Reynolds number limit — Reynolds number above which the flow is turbulent

4e+3 (default) | positive unitless scalar

Reynolds number above which the flow is turbulent. Below this threshold, the flow gradually transitions to laminar, reaching the laminar regime at the **Laminar flow upper Reynolds number limit** setting.

Nominal mass flow rate — Pipe mass flow rate

[0.1 1] kg/s (default) | scalar or vector of numbers in units of mass/time

Pipe nominal mass flow rate used to calculate the pressure loss coefficient, specified as a scalar or a vector. All nominal values must be greater than 0 and have the same number of elements as the **Nominal pressure drop** parameter. When this parameter is supplied as a vector, the scalar value K_p is determined as a least-squares fit of the vector elements.

Dependencies

To enable this parameter, set **Viscous friction parameterization** to Nominal pressure drop vs. nominal mass flow rate.

Nominal pressure drop — Pressure drop over the pipe

[0.001 0.01] MPa (default) | scalar or vector of numbers in units of pressure

Pipe nominal pressure drop used to calculate the pressure loss coefficient, specified as a scalar or a vector. All nominal values must be greater than 0 and have the same number of elements as the **Nominal mass flow rate** parameter. When this parameter is supplied as a vector, the scalar value K_p is determined as a least-squares fit of the vector elements.

Dependencies

To enable this parameter, set **Viscous friction parameterization** to Nominal pressure drop vs. nominal mass flow rate.

Mass flow rate threshold for flow reversal – Threshold below which numerical smoothing is applied

1e-6 kg/s (default) | positive scalar in units of mass/time

Mass flow rate threshold for reversed flow. A transition region is defined around 0 kg/s between the positive and negative values of the mass flow rate threshold. Within this transition region, numerical smoothing is applied to the flow response. The threshold value must be greater than 0.

Dependencies

To enable this parameter, set **Viscous friction parameterization** to Nominal pressure drop vs. nominal mass flow rate.

Reynolds number vector for turbulent Darcy friction factor – Reynolds numbers at which to tabulate the Darcy friction factor

[400 1000 1.5e+3 3e+3 4e+3 6e+3 1e+4 2e+4 4e+4 6e+4 1e+5 1e+8] (default) | vector of positive unitless numbers

Vector of Reynolds numbers for the tabular parameterization of the Darcy friction factor. The vector elements form an independent axis with the **Darcy friction factor vector** parameter. The vector elements must be listed in ascending order and must be greater than 0. For reversed flows, or flows from **B** to **A**, the same data is applied in the opposite direction.

Dependencies

To enable this parameter, set **Viscous friction parameterization** to Tabulated data - Darcy friction factor vs. Reynolds number.

Darcy friction factor vector – Darcy friction factors at the tabulated Reynolds numbers

[0.264 0.112 0.07099999999999999 0.0417 0.0387 0.0268 0.025 0.0232 0.0226 0.022 0.0214 0.0214] (default) | vector of positive unitless numbers

Vector of Darcy friction factors for the tabular parameterization of the Darcy friction factor. The vector elements must correspond one-to-one with the elements in the **Reynolds number vector for turbulent Darcy friction factor** parameter, and must be unique and greater than or equal to 0.

Dependencies

To enable this parameter, set **Viscous friction parameterization** to Tabulated data - Darcy friction factor vs. Reynolds number.

Heat Transfer**Heat transfer parameterization – Method by which to capture the convective heat transfer with the pipe wall**

Gnielinski correlation|Nominal temperature differential vs. nominal mass flow rate (default)|Dittus-Boelter correlation|Tabulated data - Colburn factor vs. Reynolds number|Tabulated data - Nusselt number vs. Reynolds number & Prandtl number

Method of calculating the heat transfer coefficient between the fluid and the pipe wall. Analytical and tabulated data parameterizations are available.

Nusselt number for laminar flow heat transfer – Nusselt number to use in the heat transfer calculations for laminar flows

3.66 (default)

Ratio of convective to conductive heat transfer in the laminar flow regime. The fluid Nusselt number influences the heat transfer rate.

Dependencies

To enable this parameter, set **Heat transfer parameterization** to either:

- Gnielinski correlation.
- Nominal temperature differential vs. nominal mass flow rate.
- Dittus-Boelter correlation.

Nominal mass flow rate – Pipe mass flow rate

[0.1 1] kg/s (default) | scalar or vector of numbers in units of mass/time

Pipe nominal mass flow rate used to calculate the heat transfer coefficient, specified as a scalar or a vector. All nominal values must be greater than 0 and have the same number of elements as the **Nominal inflow temperature** parameter. When this parameter is supplied as a vector, the scalar value h_p is determined as a least-squares fit of the vector elements.

Dependencies

To enable this parameter, set **Heat transfer parameterization** to Nominal temperature differential vs. nominal mass flow rate.

Nominal inflow temperature – Pipe inlet temperature

[293.15 293.15] K (default) | scalar or vector of numbers in units of temperature

Nominal fluid inlet temperature used to calculate the heat transfer coefficient, specified as a scalar or a vector. All nominal values must be greater than 0 and have the same number of elements as the **Nominal mass flow rate** parameter. When this parameter is supplied as a vector, the scalar value h is determined as a least-squares fit of the vector elements.

Dependencies

To enable this parameter, set **Heat transfer parameterization** to Nominal temperature differential vs. nominal mass flow rate.

Nominal outflow temperature – Pipe outlet temperature

[300 300] K (default) | scalar or vector of numbers in units of temperature

Nominal fluid outlet temperature used to calculate the heat transfer coefficient, specified as a scalar or a vector. All nominal values must be greater than 0 and have the same number of elements as the **Nominal mass flow rate** parameter. When this parameter is supplied as a vector, the scalar value h is determined as a least-squares fit of the vector elements.

Dependencies

To enable this parameter, set **Heat transfer parameterization** to Nominal temperature differential vs. nominal mass flow rate.

Nominal inflow pressure – Pipe inlet pressure

[0.101325 0.101325] MPa (default) | scalar or vector of numbers in units of pressure

Nominal fluid inlet pressure used to calculate the heat transfer coefficient, specified as a scalar or a vector. All nominal values must be greater than 0 and have the same number of elements as the **Nominal mass flow rate** parameter. When this parameter is supplied as a vector, the scalar value h is determined as a least-squares fit of the vector elements.

Dependencies

To enable this parameter, set **Heat transfer parameterization** to Nominal temperature differential vs. nominal mass flow rate.

Nominal wall temperature — Pipe wall temperature

[303.15 303.15] K (default) | scalar or vector of numbers in units of temperature

Pipe wall temperature used to calculate the heat transfer coefficient, specified as a scalar or a vector. All nominal values must be greater than 0 and have the same number of elements as the **Nominal mass flow rate** parameter. When this parameter is supplied as a vector, the scalar value h is determined as a least-squares fit of the vector elements.

Dependencies

To enable this temperature, set **Heat transfer parameterization** to Nominal temperature differential vs. nominal mass flow rate.

Coefficient a — Empirical constant a of the Dittus-Boelter correlation

0.023 (default) | positive unitless scalar

Empirical constant a to use in the Dittus-Boelter correlation. The correlation relates the Nusselt number in turbulent flows to the heat transfer coefficient.

Dependencies

To enable this parameter, set **Heat transfer parameterization** to Dittus-Boelter correlation.

Exponent b — Empirical constant b of the Dittus-Boelter correlation

0.8 (default) | positive unitless scalar

Empirical constant b to use in the Dittus-Boelter correlation. The correlation relates the Nusselt number in turbulent flows to the heat transfer coefficient.

Dependencies

To enable this parameter, set **Heat transfer parameterization** to Dittus-Boelter correlation.

Exponent c — Empirical constant c of the Dittus-Boelter correlation

0.4 (default) | positive unitless scalar

Empirical constant c to use in the Dittus-Boelter correlation. The correlation relates the Nusselt number in turbulent flows to the heat transfer coefficient. The default value reflects heat transfer to the fluid.

Dependencies

To enable this parameter, set **Heat transfer parameterization** to Dittus-Boelter correlation.

Reynolds number vector for Colburn factor — Reynolds numbers at which to tabulate the Colburn factor

[100 150 1000] (default) | vector of positive unitless numbers

Vector of Reynolds numbers for the tabular parameterization of the Colburn factor. The vector elements form an independent axis with the **Colburn factor vector** parameter. The vector elements must be listed in ascending order and must be greater than 0. This parameter must have the same number of elements as the **Colburn factor vector**. For reversed flows, or flows from **B** to **A**, the same data is applied in the opposite direction.

Dependencies

To enable this parameter, set **Heat transfer parameterization** to Tabulated data - Colburn factor vs. Reynolds number.

Colburn factor vector – Colburn factors at which the tabulated Reynolds numbers

[0.019 0.013 0.002] (default) | vector of positive unitless numbers

Vector of Colbrun factors for the tabular parameterization of the Colburn factor. The vector elements form an independent axis with the **Reynolds number vector for Colburn factor** parameter. This parameter must have the same number of elements as the **Reynolds number vector for Colburn factor**.

Dependencies

This parameter is active when the **Heat transfer parameterization** block parameter is set to Tabulated data - Colburn factor vs. Reynolds number.

Reynolds number vector for Nusselt number – Reynolds number at which to tabulate the Nusselt number

[100 150 100] (default) | vector of positive unitless numbers

Vector of Reynolds numbers for the tabular parameterization of Nusselt number. This vector forms an independent axis with the **Prandtl number vector for Nusselt number** parameter for the 2-D dependent **Nusselt number table**. The vector elements must be listed in ascending order and must be greater than 0.

Dependencies

To enable this parameter, set **Heat transfer parameterization** to Tabulated data - Nusselt number vs. Reynolds number & Prandtl number.

Prandtl number vector for Nusselt number – Prandtl numbers at which to tabulate the Nusselt number

[1 10] (default) | vector of positive unitless numbers

Vector of Prandtl numbers for the tabular parameterization of Nusselt number. This vector forms an independent axis with the **Reynolds number vector for Nusselt number** parameter for the 2-D dependent **Nusselt number table**. The vector elements must be listed in ascending order.

Dependencies

To enable this parameter, set **Heat transfer parameterization** to Tabulated data - Nusselt number vs. Reynolds number & Prandtl number.

Nusselt number table – Nusselt numbers at the tabulated Reynolds and Prandtl numbers

[3.72 4.21; 3.75 4.44; 4.21 7.15] (default) | matrix of positive unitless numbers

M -by- N matrix of Nusselt numbers at the specified Reynolds and Prandtl numbers. Linear interpolation is employed between table elements. M and N are the sizes of the corresponding vectors:

- M is the number of vector elements in the **Reynolds number vector for Nusselt number** parameter.
- N is the number of vector elements in the **Prandtl number vector for Nusselt number** parameter.

Dependencies

To enable this parameter, set **Heat transfer parameterization** to Tabulated data - Nusselt number vs. Reynolds number & Prandtl number.

Initial Conditions

Initial liquid temperature – Absolute temperature in the pipe at the start of simulation

293.15 K (default) | positive scalar or vector in units of temperature

Liquid temperature at the start of the simulation, specified as a scalar or vector. A vector n elements long defines the liquid temperature for each of n pipe segments. If the vector is two elements long, the temperature along the pipe is linearly distributed between the two element values. If the vector is three or more elements long, the initial temperature in the n th segment is set by the n th element of the vector.

Initial liquid pressure – Absolute pressure in the pipe at the start of simulation

0.101325 MPa (default) | positive scalar or vector in units of pressure

Absolute liquid pressure at the start of the simulation, specified as a scalar or vector. A vector n elements long defines the liquid pressure for each of n pipe segments. If the vector is two elements long, the pressure along the pipe is linearly distributed between the two element values. If the vector is three or more elements long, the initial pressure in the n th segment is set by the n th element of the vector.

Extended Capabilities

C/C++ Code Generation

Generate C and C++ code using Simulink® Coder™.

See Also

Sudden Area Change (TL) | Pipe (IL)

Introduced in R2016a

Pipe (IL)

Pipe segment in an isothermal liquid network

Library: Simscape / Fluids / Isothermal Liquid / Pipes & Fittings



Description

The Pipe (IL) block models flow in a rigid or flexible-walled pipe with losses due to wall friction. The effects of dynamic compressibility, fluid inertia, and pipe elevation can be optionally modeled. You can define multiple pipe segments and set the liquid pressure for each segment. By segmenting the pipe and setting **Fluid inertia** to **On**, you can model events such as water hammer in your system.

Pipe Characteristics

The pipe block can be divided into segments with the **Number of segments** parameter. When the pipe is composed of a number of segments, the pressure in each segment is calculated based on the inlet pressure and the effect on the segment mass flow rate of the fluid compressibility and wall flexibility, if applicable. The fluid volume in each segment remains fixed. For a two-segment pipe, the pressure evolves linearly with respect to the pressure defined at ports **A** and **B**. For a pipe with three or more segments, you can specify the fluid pressure in each segment in vector or scalar form in the **Initial liquid pressure** parameter. The scalar form will apply a constant value over all segments.

Flexible Walls

You can model flexible walls for all cross-sectional geometries. When you set **Pipe wall specification** to **Flexible**, the block assumes uniform expansion along all directions and preserves the defined cross-sectional shape. This may not result in physical results for noncircular cross-sectional areas undergoing high pressure relative to atmospheric pressure. Two options are available for modeling the volumetric expansion of a cross-sectional area:

- 1 **Cross-sectional area vs. pressure**, where the change in volume is modeled by:

$$\dot{V} = L \left(\frac{S_N + K_{ps}(p - p_{atm}) - S}{\tau} \right),$$

where:

- L is the **Pipe length**.
- S_N is the nominal pipe cross-sectional area defined for each shape.
- S is the current pipe cross-sectional area.
- p is the internal pipe pressure.
- p_{atm} is the atmospheric pressure.
- K_{ps} is the **Static pressure-cross sectional area gain**.

Assuming uniform elastic deformation of a thin-walled, open-ended cylindrical pipe, you can calculate K_{ps} as:

$$K_{ps} = \frac{\Delta D}{\Delta p} = \frac{\pi D_N^3}{4tE},$$

where t is the pipe wall thickness and E is Young's modulus.

- τ is the **Volumetric expansion time constant**.

2 Hydraulic diameter vs. pressure, where the change in volume is modeled by:

$$\dot{V} = \frac{\pi}{2}DL \left(\frac{D_N + K_{pd}(p - p_{atm}) - D}{\tau} \right),$$

where:

- D_N is the nominal hydraulic diameter defined for each shape.
- D is the current pipe hydraulic diameter.
- K_{pd} is the **Static pressure-hydraulic diameter gain**. Assuming uniform elastic deformation of a thin-walled, open-ended cylindrical pipe, you can calculate K_{pd} as:

$$K_{pd} = \frac{\Delta D}{\Delta p} = \frac{D_N^2}{2tE}.$$

When flexible walls are not modeled, $S_N = S$ and $D_N = D$.

Circular

The nominal hydraulic diameter and the **Pipe diameter**, d_{circle} , are the same. The pipe cross sectional area is: $S_N = \frac{\pi}{4}d_{circle}^2$.

Annular

The nominal hydraulic diameter, $D_{h,nom}$, is the difference between the **Pipe outer diameter** and **Pipe inner diameter**, $d_o - d_i$. The pipe cross sectional area is $S_N = \frac{\pi}{4}(d_o^2 - d_i^2)$.

Rectangular

The nominal hydraulic diameter is:

$$D_N = \frac{2hw}{h+w},$$

where:

- h is the **Pipe height**.
- w is the **Pipe width**.

The pipe cross sectional area is $S_N = wh$.

Elliptical

The nominal hydraulic diameter is:

$$D_N = 2a_{maj}b_{min} \frac{\left(64 - 16 \left(\frac{a_{maj} - b_{min}}{a_{maj} + b_{min}} \right)^2 \right)}{(a_{maj} + b_{min}) \left(64 - 3 \left(\frac{a_{maj} - b_{min}}{a_{maj} + b_{min}} \right)^4 \right)},$$

where:

- a_{maj} is the **Pipe major axis**.
- b_{min} is the **Pipe minor axis**.

The pipe cross sectional area is $S_N = \frac{\pi}{4} a_{\text{maj}} b_{\text{min}}$.

Isosceles Triangular

The nominal hydraulic diameter is:

$$D_N = l_{\text{side}} \frac{\sin(\theta)}{1 + \sin\left(\frac{\theta}{2}\right)}$$

where:

- l_{side} is the **Pipe side length**.
- θ is the **Pipe vertex angle**.

The pipe cross sectional area is $S_N = \frac{l_{\text{side}}^2}{2} \sin(\theta)$.

Pressure Loss Due to Friction

Haaland Correlation

The analytical Haaland correlation models losses due to wall friction either by *aggregate equivalent length*, which accounts for resistances due to nonuniformities as an added straight-pipe length that results in equivalent losses, or by *local loss coefficient*, which directly applies a loss coefficient for pipe nonuniformities.

When the **Local resistances specification** parameter is set to **Aggregate equivalent length** and the flow in the pipe is lower than the **Laminar flow upper Reynolds number limit**, the pressure loss over all pipe segments is:

$$\Delta p_{f,A} = \frac{\nu \lambda}{2D^2 S} \frac{L + L_{\text{add}}}{2} \dot{m}_A,$$

$$\Delta p_{f,B} = \frac{\nu \lambda}{2D^2 S} \frac{L + L_{\text{add}}}{2} \dot{m}_B,$$

where:

- ν is the fluid kinematic viscosity.
- λ is the **Laminar friction constant for Darcy friction factor**, which you can define when **Cross-sectional geometry** is set to **Custom** and is otherwise equal to 64.
- D is the pipe hydraulic diameter.
- L_{add} is the **Aggregate equivalent length of local resistances**.
- \dot{m}_A is the mass flow rate at port **A**.
- \dot{m}_B is the mass flow rate at port **B**.

When the Reynolds number is greater than the **Turbulent flow lower Reynolds number limit**, the pressure loss in the pipe is:

$$\Delta p_{f,A} = \frac{f}{2\rho_I S^2} \frac{L + L_{add}}{2} \dot{m}_A |\dot{m}_A|,$$

$$\Delta p_{f,B} = \frac{f}{2\rho_I S^2} \frac{L + L_{add}}{2} \dot{m}_B |\dot{m}_B|,$$

where:

- f is the Darcy friction factor. This is approximated by the empirical Haaland equation and is based on the **Surface roughness specification**, ε , and pipe hydraulic diameter:

$$f = \left\{ -1.8 \log_{10} \left[\frac{6.9}{\text{Re}} + \left(\frac{\varepsilon}{3.7 D_h} \right)^{1.11} \right] \right\}^{-2},$$

Pipe roughness for brass, lead, copper, plastic, steel, wrought iron, and galvanized steel or iron are provided as ASHRAE standard values. You can also supply your own **Internal surface absolute roughness** with the Custom setting.

- ρ_I is the internal fluid density.

When the **Local resistances specification** parameter is set to Local loss coefficient and the flow in the pipe is lower than the **Laminar flow upper Reynolds number limit**, the pressure loss over all pipe segments is:

$$\Delta p_{f,A} = \frac{\nu \lambda}{2D^2 S} \frac{L}{2} \dot{m}_A.$$

$$\Delta p_{f,B} = \frac{\nu \lambda}{2D^2 S} \frac{L}{2} \dot{m}_B.$$

When the Reynolds number is greater than the **Turbulent flow lower Reynolds number limit**, the pressure loss in the pipe is:

$$\Delta p_{f,A} = \left(\frac{fL}{D} + C_{loss,total} \right) \frac{1}{2\rho_I S^2} \dot{m}_A |\dot{m}_A|,$$

$$\Delta p_{f,B} = \left(\frac{fL}{D} + C_{loss,total} \right) \frac{1}{2\rho_I S^2} \dot{m}_B |\dot{m}_B|,$$

where $C_{loss,total}$ is the loss coefficient, which can be defined in the **Total local loss coefficient** parameter as either a single coefficient or the sum of all loss coefficients along the pipe.

Nominal Pressure Drop vs. Nominal Mass Flow Rate

The Nominal Pressure Drop vs. Nominal Mass Flow Rate parameterization characterizes losses with a loss coefficient for rigid or flexible walls. When the fluid is incompressible, the pressure loss over the entire pipe due to wall friction is:

$$\Delta p_{f,A} = K_p \dot{m}_A \sqrt{\dot{m}_A^2 + \dot{m}_{th}^2},$$

where K_p is:

$$K_p = \frac{\Delta p_N}{\dot{m}_N^2},$$

where:

- Δp_N is the **Nominal pressure drop**, which can be defined either as a scalar or a vector.
- \dot{m}_N is the **Nominal mass flow rate**, which can be defined either as a scalar or a vector.

When the **Nominal pressure drop** and **Nominal mass flow rate** parameters are supplied as vectors, the scalar value K_p is determined from a least-squares fit of the vector elements.

Tabulated Data - Darcy Friction Factor vs. Reynolds Number

Pressure losses due to viscous friction can also be determined from user-provided tabulated data of the **Darcy friction factor vector** and the **Reynolds number vector for turbulent Darcy friction factor** parameters. Linear interpolation is employed between data points.

Momentum Balance

For an incompressible fluid, the mass flow into the pipe equals the mass flow out of the pipe:

$$\dot{m}_A + \dot{m}_B = 0.$$

When the fluid is compressible and pipe walls are rigid, the difference between the mass flow into and out of the pipe depends on the fluid density change due to compressibility:

$$\dot{m}_A + \dot{m}_B = \dot{\rho}_I \frac{d\rho_I}{dp_I} V,$$

When the fluid is compressible and the pipe walls are flexible, the difference between the mass flow into and out of the pipe is based on the change in fluid density due to compressibility, and the amount of fluid accumulated in the newly deformed regions of the pipe:

$$\dot{m}_A + \dot{m}_B = \dot{\rho}_I \frac{d\rho_I}{dp_I} V + \rho_I \dot{V}.$$

The changes in momentum between the pipe inlet and outlet comprises the changes in pressure due to pipe wall friction, which is modeled according to the **Viscous friction parameterization** and pipe elevation. For a pipe that does not model fluid inertia, the momentum balance is:

$$p_A - p_I = \Delta p_{f,A} + \rho_I \frac{\Delta z}{2} g,$$

$$p_B - p_I = \Delta p_{f,B} - \rho_I \frac{\Delta z}{2} g,$$

where:

- p_A is the pressure at port **A**.
- p_I is the fluid volume internal pressure.
- p_B is the pressure at port **B**.
- Δp_f is the pressure loss due to wall friction, parameterized by the **Viscous friction losses** specification according to the respective port.

- Δz is the pipe elevation. In the case of constant-elevation pipes, this is the **Elevation gain from port A to port B** parameter; otherwise, it is received as a physical signal at port **EL**.
- g is the gravitational acceleration. In the case of a fixed gravitational constant, this is the **Gravitational acceleration** parameter; otherwise, it is received as a physical signal at port **G**.

For a pipe with modeled fluid inertia, the momentum balance is:

$$p_A - p_I = \Delta p_{f,A} + p_I \frac{\Delta z}{2} g + \ddot{m}_A \frac{L}{2S},$$

$$p_B - p_I = \Delta p_{f,B} - p_I \frac{\Delta z}{2} g + \ddot{m}_B \frac{L}{2S},$$

where:

- \ddot{m} is the fluid acceleration at its respective port.
- S is the pipe cross-sectional area.

Ports

Conserving

A – Liquid port

isothermal liquid

Liquid entry or exit port.

B – Liquid port

isothermal liquid

Liquid entry or exit port.

Inputs

EL – Elevation

physical signal

Variable elevation from port **A** to port **B**, specified as a physical signal. The elevation magnitude must be less than or equal to the pipe length. If the signal falls below the value of **-Pipe length**, the value at **EL** is maintained at **-pipe length**. If the signal exceeds the value of **Pipe length**, the value at **EL** is maintained at **pipe length**.

Dependencies

To enable this port, set **Elevation gain specification** to Variable.

G – Gravitational acceleration

physical signal

Variable gravitational acceleration, specified as a physical signal.

Dependencies

To enable this port, set **Gravitational acceleration specification** to Variable.

Parameters

Configuration

Pipe length — Pipe length

5 m (default) | positive scalar

Total pipe length across all pipe segments.

Number of segments — Number of pipe divisions

1 (default) | positive integer

Number of pipe divisions. Each division represents an individual segment for which pressure is calculated, depending on the pipe inlet pressure, fluid compressibility, and wall flexibility, if applicable. The fluid volume in each segment remains fixed.

Cross-sectional geometry — Pipe geometry

Circular (default) | Annular | Rectangular | Elliptical | Isosceles triangular | Custom

Cross-sectional pipe geometry. A nominal hydraulic diameter and nominal cross-sectional area is calculated based on the cross-sectional geometry.

Pipe diameter — Pipe diameter

0.1 m (default) | positive scalar

Diameter for circular cross-sectional pipes.

Dependencies

To enable this parameter, set **Cross-sectional geometry** to Circular.

Pipe inner diameter — Pipe inner diameter

0.05 m (default) | positive scalar

Inner diameter for annular pipe flow, or flow between two concentric pipes.

Dependencies

To enable this parameter, set **Cross-sectional geometry** to Annular.

Pipe outer diameter — Pipe outer diameter

0.1 m (default) | positive scalar

Outer diameter for annular pipe flow, or flow between two concentric pipes.

Dependencies

To enable this parameter, set **Cross-sectional geometry** to Annular.

Pipe width — Rectangular pipe width

0.1 m (default) | positive scalar

Width of rectangular pipe.

Dependencies

To enable this parameter, set **Cross-sectional geometry** to Rectangular.

Pipe height — Rectangular pipe height

0.1 m (default) | positive scalar

Height of rectangular pipe.

Dependencies

To enable this parameter, set **Cross-sectional geometry** to Rectangular.

Pipe major axis — Ellipsoidal pipe major axis

0.1 m (default) | positive scalar

Major axis for ellipsoidal pipes.

Dependencies

To enable this parameter, set **Cross-sectional geometry** to Elliptical.

Pipe minor axis — Ellipsoidal pipe minor axis

0.05 m (default) | positive scalar

Minor axis for ellipsoidal pipes.

Dependencies

To enable this parameter, set **Cross-sectional geometry** to Elliptical.

Pipe side length — Triangular pipe side length

0.1 m (default) | positive scalar

Length of the two equal sides of isosceles-triangular pipes.

Dependencies

To enable this parameter, set **Cross-sectional geometry** to Isosceles triangular.

Pipe vertex angle — Triangular pipe vertex angle

30 deg (default) | positive scalar

Vertex angle for triangular pipes. The value must be less than 180 degrees.

Dependencies

To enable this parameter, set **Cross-sectional geometry** to Isosceles triangular.

Hydraulic diameter — Hydraulic diameter

0.1128 m (default) | positive scalar

Hydraulic diameter used in calculations of the pipe Reynolds number. For noncircular pipes, the hydraulic diameter is the effective diameter of the fluid in the pipe. For circular pipes, the hydraulic diameter and pipe diameter are the same.

Dependencies

To enable this parameter, set **Cross-sectional geometry** to Custom.

Cross-sectional area — Pipe cross-sectional area

0.01 m² (default) | positive scalar

Pipe cross-sectional area for a custom pipe geometry.

Dependencies

To enable this parameter, set **Cross-sectional geometry** to Custom.

Fluid dynamic compressibility – Whether to model fluid compressibility

On (default) | Off

Whether to model any change in fluid density due to fluid compressibility. When **Fluid compressibility** is set to On, changes due to the mass flow rate into the block are calculated in addition to density changes due to changes in pressure. In the Isothermal Liquid Library, all blocks calculate density as a function of pressure.

Fluid inertia – Fluid acceleration

Off (default) | On

Whether to account for resistance to changes in the flow rate due to the fluid mass.

Dependencies

To enable this parameter, set **Fluid dynamic compressibility** to On.

Elevation gain specification – Pipe elevation specification

Constant (default) | Variable

Whether the pipe elevation remains constant or variable from port **A** to **B**.

Elevation gain from port A to port B – Constant pipe elevation differential

0 m (default) | scalar

Elevation differential for constant-elevation pipes. The elevation gain must be less than or equal to the **Pipe length**.

Dependencies

To enable this parameter, set **Elevation gain specification** to Constant.

Gravitational acceleration specification – Acceleration specification

Constant (default) | Variable

Whether the gravitational constant is constant or variable.

Gravitational acceleration – Gravitational acceleration

9.81 m/s² (default) | positive scalar

Gravitational acceleration for environments with constant gravitational acceleration.

Dependencies

To enable this parameter, set **Gravitational acceleration specification** to Constant.

Viscous Friction

Viscous friction parameterization – Method of calculating pressure loss due to wall friction

Haaland correlation (default) | Nominal pressure drop vs. nominal mass flow rate |
Tabulated data - Darcy friction factor vs. Reynolds number

Parameterization of pressure losses due to wall friction. Both analytical and tabular formulations are available.

Local resistances specification – Method for quantifying pressure losses in the Haaland correlation

Aggregate equivalent length (default) | Local loss coefficient

Method for quantifying pressure losses due to pipe nonuniformities.

Dependencies

To enable this parameter, set **Viscous friction parameterization** to Haaland correlation.

Total local loss coefficient – Defines loss coefficient over the pipe

0.1 (default) | positive scalar

Loss coefficient associated with each pipe nonuniformity. You can input a single loss coefficient or the sum of all loss coefficients along the pipe.

Dependencies

To enable this parameter, set **Viscous friction parameterization** to Haaland correlation and **Local resistance specifications** to Local loss coefficient.

Aggregate equivalent length of local resistances – Contribution of pipe geometry to hydraulic losses

1 m (default) | positive scalar

Length of pipe that would produce the equivalent hydraulic losses as would a pipe with bends, area changes, or other nonuniform attributes. The effective length of the pipe is the sum of the **Pipe length** and the **Aggregate equivalent length of local resistances**.

Dependencies

To enable this parameter, set **Viscous friction parameterization** to Haaland correlation and **Local resistance specifications** to Aggregate equivalent length.

Surface roughness specification – Pipe material for roughness specification

Commercially smooth brass, lead, copper, or plastic pipe: 1.52 um (default) |
Steel and wrought iron : 46 um | Galvanized iron or steel : 152 um | Cast iron :
259 um | Custom

Absolute surface roughness based on pipe material. The provided values are ASHRAE standard roughness values. You can also input your own value by setting **Surface roughness specification** to Custom.

Dependencies

To enable this parameter, set **Viscous friction parameterization** to Haaland correlation.

Internal surface absolute roughness – Pipe wall roughness

15e-6 m (default) | positive scalar

Pipe wall absolute roughness. This parameter is used to determine the Darcy friction factor, which contributes to pressure loss in the pipe.

Dependencies

To enable this parameter, set **Viscous friction parameterization** to Haaland correlation and **Surface roughness specification** to Custom.

Laminar flow upper Reynolds number limit — Laminar flow upper threshold

2000 (default) | positive scalar

Upper Reynolds number limit to laminar flow. Beyond this number, the fluid regime is transitional, approaches the turbulent regime, and becomes fully turbulent at the **Turbulent flow lower Reynolds number limit**.

Dependencies

To enable this parameter, set **Viscous friction parameterization** to either:

- Haaland correlation
- Tabulated data - Darcy friction factor vs. Reynolds number

Turbulent flow lower Reynolds number limit — Turbulent flow lower threshold

4000 (default) | positive scalar

Lower Reynolds number limit for turbulent flow. Below this number, the flow regime is transitional, approaches laminar flow, and becomes fully laminar at the **Laminar flow upper Reynolds number limit**.

Dependencies

To enable this parameter, set **Viscous friction parameterization** to either:

- Haaland correlation
- Tabulated data - Darcy friction factor vs. Reynolds number

Nominal mass flow rate — Mass flow rate for calculating loss coefficient

[.1, 1] kg/s (default) | positive scalar | 1-by-*n* vector

Nominal mass flow rate used for calculating the pressure loss coefficient for rigid and flexible pipes, specified as a scalar or a vector. All nominal values must be greater than 0 and have the same number of elements as the **Nominal pressure drop** parameter. When this parameter is supplied as a vector, the scalar value K_{loss} is determined as a least-squares fit of the vector elements.

Dependencies

To enable this parameter, set **Viscous friction parameterization** to Nominal pressure drop vs. nominal mass flow rate.

Nominal pressure drop — Pressure drop for calculating loss coefficient

[.001, .01] MPa (default) | positive scalar | 1-by-*n* vector

Nominal pressure drop used for calculating the pressure loss coefficient for rigid and flexible pipes, specified as a scalar or vector. All nominal values must be greater than 0 and must have the same number of elements as the **Nominal mass flow rate** parameter. When this parameter is supplied as a vector, the scalar value K_{loss} is determined as a least-squares fit of the vector elements.

Dependencies

To enable this parameter, set **Viscous friction parameterization** to Nominal pressure drop vs. nominal mass flow rate.

Mass flow rate threshold for flow reversal – Mass flow rate threshold

1e-6 kg/s (default) | positive scalar

Mass flow rate threshold for reversed flow. A transition region is defined around 0 kg/s between the positive and negative values of the mass flow rate threshold. Within this transition region, numerical smoothing is applied to the flow response. The threshold value must be greater than 0.

Dependencies

To enable this parameter, set **Viscous friction parameterization** to Nominal pressure drop vs. nominal mass flow rate.

Reynolds number vector for turbulent Darcy friction factor – Vector of Reynolds numbers for tabular parameterization

[400, 1000, 1500, 3000, 4000, 6000, 10000, 20000, 40000, 60000, 100000, 100000000] (default) | 1-by- n vector

Vector of Reynolds numbers for the tabular parameterization of the Darcy friction factor. The vector elements form an independent axis with the **Darcy friction factor vector** parameter. The vector elements must be listed in ascending order. A positive Reynolds number corresponds to flow from port **A** to port **B**. A negative Reynolds number corresponds to flow from port **B** to **A**. If you provide a vector with only positive or only negative elements, the same data set is extended for flows in the opposite direction.

Dependencies

To enable this parameter, set **Viscous friction parameterization** to Tabulated data - Darcy friction factor vs. Reynolds number.

Darcy friction factor vector – Vector of friction factors for tabular parameterization

[.264, .112, .071, .0417, .0387, .0268, .025, .0232, .0226, .022, .0214, .0214] (default) | 1-by- n vector

Vector of Darcy friction factors for the tabular parameterization of the Darcy friction factor. The vector elements must correspond one-to-one with the elements in the **Reynolds number vector for turbulent Darcy friction factor** parameter, and must be unique and greater than or equal to 0.

Dependencies

To enable this parameter, set **Viscous friction parameterization** to Tabulated data - Darcy friction factor vs. Reynolds number.

Laminar friction constant for Darcy friction factor – Friction constant for laminar flows

64 (default) | positive scalar

Friction constant for laminar flows. The Darcy friction factor captures the contribution of wall friction in pressure loss calculations. If **Cross-sectional geometry** is not set to Custom, this parameter is internally set to 64.

Dependencies

To enable this parameter, set **Viscous friction parameterization** to either:

- Haaland correlation
- Tabulated data - Darcy friction factor vs. Reynolds number

and **Cross-sectional geometry** to Custom.

Pipe Wall**Pipe wall specification – Specifies wall flexibility**

Rigid (default) | Flexible

Specifies wall flexibility. This parameter is independent of pipe cross-sectional geometry. The **Flexible** setting preserves the initial pipe shape and applies equal expansion of the cross-sectional area. It may not be accurate for non-circular cross-sectional geometry under high deformation.

Dependencies

To enable this parameter, set **Fluid dynamic compressibility** to On.

Volumetric expansion specification – Linear expansion correlation

Cross-sectional area vs. pressure (default) | Hydraulic diameter vs. pressure

Linear expansion correlation. The settings correlate the new cross-sectional area or hydraulic diameter to the pipe pressure.

Dependencies

To enable this parameter, set **Fluid dynamic compressibility** to On and **Pipe wall specification** to Flexible.

Static pressure-cross sectional area gain – Coefficient for area-dependent pipe deformation

$1e-6 \text{ m}^2/\text{MPa}$ (default) | positive scalar

Coefficient for calculating pipe deformation for the **Cross-sectional area vs. pressure** setting. The gain is multiplied by the pressure differential between the segment pressure and atmospheric pressure.

Dependencies

To enable this parameter, set **Fluid dynamic compressibility** to On, **Pipe wall specification** to Flexible, and **Volumetric expansion specification** to Cross-sectional area vs. pressure.

Static pressure-hydraulic diameter gain – Coefficient for diameter-dependent pipe deformation

$1e-6 \text{ m}/\text{MPa}$ (default) | positive scalar

Coefficient for calculating pipe deformation for the **Hydraulic diameter vs. pressure** setting. The gain is multiplied by the pressure differential between the segment pressure and atmospheric pressure.

Dependencies

To enable this parameter, set **Fluid dynamic compressibility** to On, **Pipe wall specification** to Flexible, and **Volumetric expansion specification** to Hydraulic diameter vs. pressure.

Volumetric expansion time constant – Pipe deformation time constant

0.01 s (default) | positive scalar

Time required for the wall to reach steady-state after pipe deformation. This parameter impacts the dynamic change in pipe volume.

Dependencies

To enable this parameter, set **Fluid dynamic compressibility** to On and **Pipe wall specification** to Flexible.

Initial Conditions**Initial liquid pressure – Initial pressure in pipe or pipe segment**

0.101325 MPa (default) | positive scalar | 1-by- n vector

Initial liquid pressure, specified as a scalar or vector. A vector n elements long defines the liquid pressure for each of n pipe segments. If the vector is two elements long, the pressure along the pipe is linearly distributed between the two element values. If the vector is three or more elements long, the initial pressure in the n th segment is set by the n th element of the vector.

Dependencies

To enable this parameter, set **Fluid dynamic compressibility** to On.

Initial mass flow rate from port A to port B – Initial mass flow rate for inertia calculation

0 kg/s (default) | scalar

Initial mass flow rate for pipes with simulated fluid inertia.

Dependencies

To enable this parameter, set **Fluid dynamic compressibility** to On and **Fluid inertia** to On.

See Also

Partially Filled Pipe (IL) | Pipe (TL) | Pipe (IL) | Elbow (IL) | T-Junction (IL) | Tank (IL)

Introduced in R2020a

Pneumo-Hydraulic Actuator

Double-acting cylinder operated by hydraulic and pneumatic power

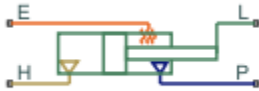

Library

Hydraulic Cylinders

Description

The Pneumo-Hydraulic Actuator block simulates a pneumo-hydraulic actuator, implemented as a double-acting cylinder with one side connected to a hydraulic power supply and another side operated by pneumatic power. Such devices are widely used as pneumo-hydraulic pumps, intensifiers, and converters of various types. The following illustration shows a few examples of the pneumo-hydraulic actuator: a) with rigid separator; b) with flexible separator; c) pneumo-hydraulic intensifier.

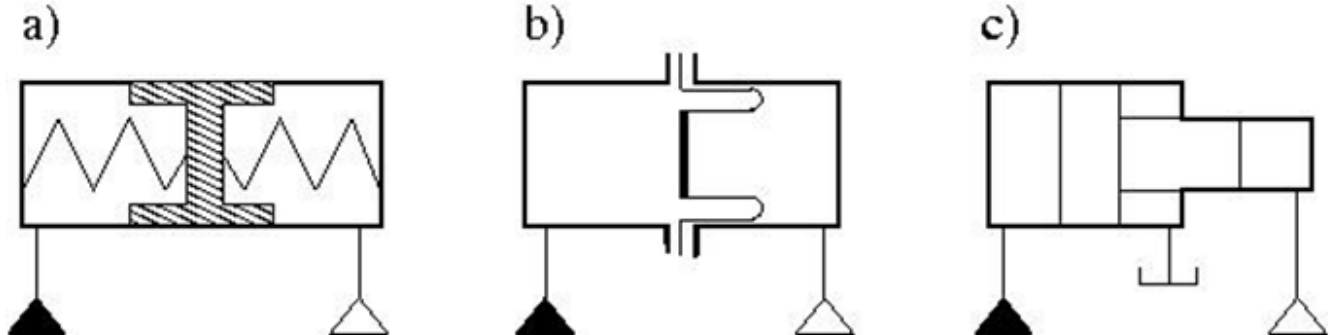

The block provides two main modeling variants, accessible by right-clicking the block in your block diagram and then selecting the appropriate option from the context menu, under **Simscape > Block choices**:

- **One mechanical port** — Use this variant to model just the load on the piston. In this case, the cylinder is assumed to be grounded.
- **Two mechanical ports** — Use this variant to model the load on the actuator cylinder, as well as the piston. This variant also lets you include liquid compressibility on the hydraulic side of the actuator.

Configuration with One Mechanical Port

Use this variant of the block when the load is applied only to the piston and the cylinder clamping structure is grounded. The hydraulic part of the model accounts only for fluid consumption associated with the piston velocity. The pneumatic part of the model is built with the ideal gas relationships. To

simulate the limit on the piston motion, the hard stop is included in the model. The piston effective area is assumed to be constant. As a result, the model is described with the following equations:

$$q_H = A_H \cdot v$$

$$F_H = A_H \cdot p$$

$$F_P = A_P \cdot p$$

$$F_{HS} = \begin{cases} K \cdot (x - stroke) + D \cdot v & \text{for } x > stroke \\ K \cdot x + D \cdot v & \text{for } x < 0 \\ 0 & \text{for } 0 \leq x \leq stroke \end{cases}$$

$$F_H = F_P + F_{HS} + F_L$$

$$v = \frac{dx}{dt}$$

$$V_P = V_0 + A_P \cdot (stroke - x)$$

$$G = \frac{V_P}{RT} \left(\frac{dp}{dt} - \frac{p}{T} \frac{dT}{dt} \right) - \frac{A_P}{RT} p \cdot v$$

$$Q_P = \frac{c_v \cdot V_P}{R} \frac{dp}{dt} - \frac{c_p \cdot A_P}{R} p \cdot v + Q_{HE}$$

where

q_H	Hydraulic volumetric flow rate
p	Pressure in the actuator chambers
A_H	Hydraulic side effective area
A_P	Pneumatic side effective area
v	Piston velocity
F_H	Force developed by piston on hydraulic side
F_P	Force developed by piston on pneumatic side
F_{HS}	Hard stop force
F_L	Force developed by external load connected to port L
K	Hard stop stiffness
D	Hard stop damping
$stroke$	Piston stroke
x	Piston displacement
V_P	Chamber volume on pneumatic side
V_0	Chamber dead volume on pneumatic side
G	Gas mass flow rate
R	Gas constant
T	Gas absolute temperature

Q_P	Heat flow through the pneumatic chamber
c_v	Gas specific heat at constant volume
c_p	Gas specific heat at constant pressure
Q_{HE}	Heat flow through the thermal port E

The model is suitable for building pneumo-hydraulic or hydro-pneumatic pumps, intensifiers, and similar devices. You can simulate piston loading (such as inertia, springs, friction) by modeling the load externally and connecting it to port L. Similarly, simulate the heat exchange with the environment through the external thermal port E, which corresponds to the gas in the chamber. Use blocks from the Simscape Foundation library, such as the Convective Heat Transfer, Conductive Heat Transfer, Thermal Mass, and so on, depending on the actual system configuration.

Port P is the pneumatic conserving port associated with the pneumatic side of the actuator. Port H is the hydraulic conserving port associated with the hydraulic inlet.

The block directionality assumes that pressure in the hydraulic chamber causes the piston to move in the positive direction, while pressure in the pneumatic chamber tends to move the piston in the negative direction. Flow rates are considered positive if they flow into the actuator.

Configuration with Two Mechanical Ports

This variant of the block is suitable when the forces on both piston and cylinder are considered. This is a composite component and is built of the following blocks from the Simscape Foundation library:

- Translational Hydro-Mechanical Converter
- Pneumatic Piston Chamber
- Translational Hard Stop

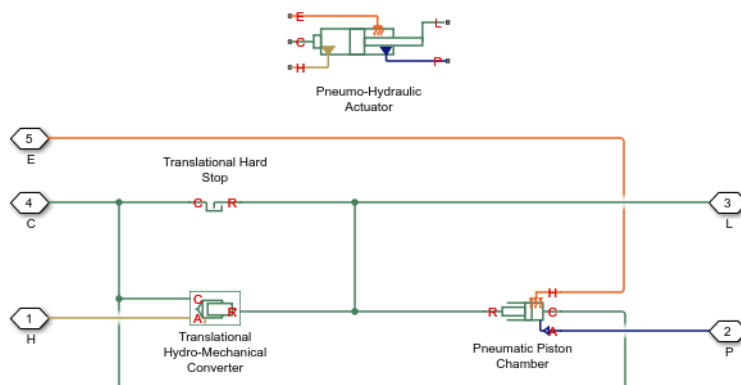

Connections R and C are mechanical translational ports corresponding to the cylinder rod and cylinder clamping structure, respectively. Connection H is a hydraulic conserving port that is connected to the hydraulic Translational Hydro-Mechanical Converter. Connection P is a pneumatic conserving port that is connected to the pneumatic port of the Pneumatic Piston Chamber block. Connection E is a thermal conserving port associated with the gas in the pneumatic chamber. The fluid pressure, either on the hydraulic or pneumatic side, is transformed into mechanical energy through the converter. The piston (rod) motion is limited with the mechanical Translational Hard Stop block in such a way that the rod can travel only between cylinder caps. The fluid compressibility can also be taken into account on the hydraulic side.

You can control the block directionality using the **Converter orientation** parameter. If the **Converter orientation** is set to **Act in positive direction**, the pressure in the hydraulic chamber causes the piston to move in the positive direction, while the pressure in the pneumatic chamber tends to move the piston in the negative direction. Flow rates are considered positive if they flow into the actuator.

Basic Assumptions and Limitations

- The effective piston area in each chamber is assumed to be constant.
- The leakage flow between chambers is assumed to be negligible because pressures in the chambers are equal.
- In **One mechanical port** configuration, on the hydraulic side, fluid compressibility is not taken into account. However, in **Two mechanical ports** configuration, you have an option to include fluid compressibility by setting the **Compressibility** parameter to **On**.
- On the pneumatic side, the mass flow rate and heat flow computations assume that the gas is ideal.
- In **One mechanical port** configuration, the cylinder is always assumed be grounded.
- In **Two mechanical ports** configuration, no loading on piston rod, such as inertia, friction, spring, and so on, is taken into account. If necessary, you can easily add them by connecting an appropriate building block to cylinder port R.

Parameters

- “Hydraulic Side Tab” on page 1-1208
- “Pneumatic Side Tab” on page 1-1209
- “Hard Stop Tab” on page 1-1209

Hydraulic Side Tab

Hydraulic side piston area

Effective piston area on the hydraulic side. The default value is $2e-3 \text{ m}^2$.

Stroke

Piston maximum travel between caps. The default value is 0.2 m .

Piston initial distance from hydraulic port H

The distance between the piston and the cap on the hydraulic side at the beginning of simulation. This value cannot exceed the piston stroke. The default value is 0 .

Compressibility

This parameter is visible only in the **Two mechanical ports** configuration. Specifies whether fluid density on the hydraulic side is taken as constant or varying with pressure. The default value is **Off**, in which case the block models an ideal transducer. If you select **On**, the block dialog box displays additional parameters that let you model dynamic variations of the liquid density without adding any extra blocks.

Hydraulic side dead volume

This parameter is visible only when the **Compressibility** parameter is set to **On**. Fluid volume in hydraulic chamber that remains in the chamber after the rod is fully retracted. The default value is $1e-4 \text{ m}^3$.

Specific heat ratio

This parameter is visible only when the **Compressibility** parameter is set to 0n. Gas-specific heat ratio. The default value is 1.4.

Initial liquid pressure (relative)

This parameter is visible only when the **Compressibility** parameter is set to 0n. The initial relative pressure of fluid in the hydraulic converter. This parameter specifies the initial condition for use in block's initial state at the beginning of a simulation run. The default value is 0.

Converter orientation

This parameter is visible only in the **Two mechanical ports** configuration. Specifies hydraulic cylinder orientation with respect to the globally assigned positive direction. The cylinder can be installed in two different ways, depending upon whether it exerts force in the positive or in the negative direction when pressure is applied at its inlet. If pressure applied at port H exerts force in negative direction, set the parameter to **Acts in negative direction**. The default value is **Acts in positive direction**.

Pneumatic Side Tab**Pneumatic side piston area**

Effective piston area on the pneumatic side. The default value is $1e-3 \text{ m}^2$.

Pneumatic side dead volume

Gas volume in pneumatic chamber that remains in the chamber after the rod is fully retracted. The default value is $1e-4 \text{ m}^3$.

Initial gas pressure (absolute)

The initial absolute gas pressure in the pneumatic chamber. The default value is 101325 Pa.

Initial gas temperature

The initial gas temperature in the pneumatic chamber. The default value is 293.15 K.

Hard Stop Tab**Hard stop stiffness**

The hard stop model implemented in the block assumes that the stop resists penetration of the piston with force proportional to the penetration. This parameter sets the stiffness of the contact between the stop and the piston. The default value is $1e6 \text{ N/m}$.

Hard stop damping

The damping in the hard stop model accounts for dissipation in the piston-stop contact. The default value is 150 N*s/m .

Restricted Parameters

When your model is in Restricted editing mode, you cannot modify the following parameters:

- **Compressibility**
- **Converter orientation**

All other block parameters are available for modification. The actual set of modifiable block parameters depends on the values of the **Compressibility** parameter at the time the model entered Restricted mode.

Ports

The block has the following ports:

H

Hydraulic conserving port associated with the actuator hydraulic chamber.

P

Pneumatic conserving port associated with the actuator pneumatic chamber.

E

Thermal conserving port associated with the gas in the pneumatic chamber. You can simulate the heat exchange with the environment through this port.

L

Mechanical translational conserving port associated with the actuator piston. You can model the load on the piston, such as external force, inertia, friction, or spring, and connect it through this port.

R

Mechanical translational conserving port associated with the actuator clamping structure, which is exposed by selecting the **Two mechanical ports** variant. You can model the load on the actuator casing through this port.

Introduced in R2012b

Poppet Valve

Hydraulic poppet valve



Library

Flow Control Valves

Description

The Poppet Valve block models a variable orifice created by a cylindrical sharp-edged stem and a conical seat.

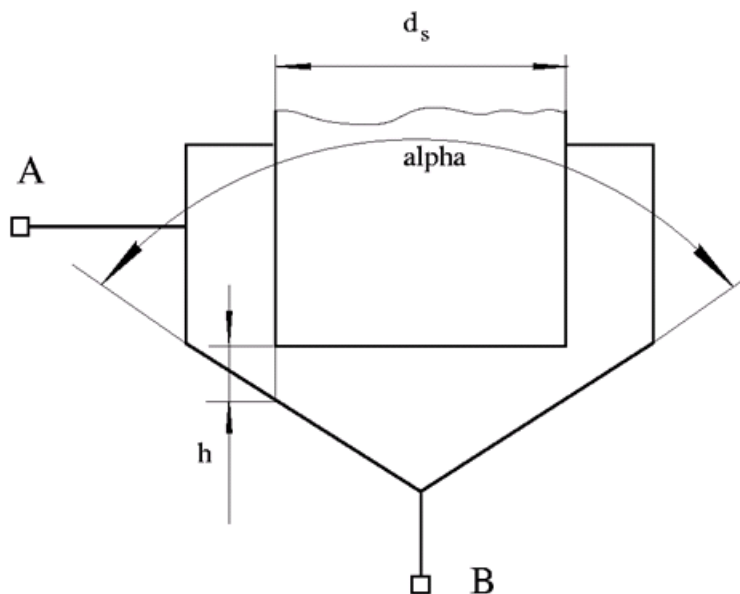

The flow rate through the valve is proportional to the valve opening and to the pressure differential across the valve. The flow rate is determined according to the following equations:

$$q = C_D \cdot A(h) \sqrt{\frac{2}{\rho} \frac{\Delta p}{(\Delta p^2 + p_{Cr}^2)^{1/4}}}$$

$$\Delta p = p_A - p_B,$$

$$h = x_0 + x$$

$$h_{\max} = d_s \frac{\sqrt{1 + \cos \frac{\alpha}{2}} - 1}{\sin \alpha}$$

$$A(h) = \begin{cases} A_{\text{leak}} & \text{for } h < = 0 \\ \pi \cdot \left(d_s + h \cdot \sin \frac{\alpha}{2} \cdot \cos \frac{\alpha}{2} \right) \cdot h \cdot \sin \frac{\alpha}{2} + A_{\text{leak}} & \text{for } 0 < h < h_{\max} \\ A_{\max} + A_{\text{leak}} & \text{for } h > = h_{\max} \end{cases}$$

$$A_{\max} = \frac{\pi d_s^2}{4}$$

where

q	Flow rate
p	Pressure differential
p_A, p_B	Gauge pressures at the block terminals
C_D	Flow discharge coefficient
$A(h)$	Instantaneous orifice passage area
x_0	Initial opening
x	Stem displacement from initial position
h	Valve opening
h_{\max}	Maximum valve opening. The passage area remains constant and equal to A_{\max} after this.
d_s	Stem diameter
α	Cone angle
ρ	Fluid density
A_{leak}	Closed valve leakage area
A_{\max}	Maximum valve open area
p_{cr}	Minimum pressure for turbulent flow

The minimum pressure for turbulent flow, p_{cr} , is calculated according to the laminar transition specification method:

- By pressure ratio — The transition from laminar to turbulent regime is defined by the following equations:

$$p_{\text{cr}} = (p_{\text{avg}} + p_{\text{atm}})(1 - B_{\text{lam}})$$

$$p_{\text{avg}} = (p_A + p_B)/2$$

where

p_{avg}	Average pressure between the block terminals
p_{atm}	Atmospheric pressure, 101325 Pa
B_{lam}	Pressure ratio at the transition between laminar and turbulent regimes (Laminar flow pressure ratio parameter value)

- By Reynolds number — The transition from laminar to turbulent regime is defined by the following equations:

$$p_{cr} = \frac{\rho}{2} \left(\frac{Re_{cr} \cdot \nu}{C_D \cdot D_H} \right)^2$$

$$D_H = \sqrt{\frac{4A}{\pi}}$$

where

D_H	Valve instantaneous hydraulic diameter
ν	Fluid kinematic viscosity
Re_{cr}	Critical Reynolds number (Critical Reynolds number parameter value)

The block positive direction is from port A to port B. This means that the flow rate is positive if it flows from A to B and the pressure differential is determined as $\Delta p = p_A - p_B$. Positive signal at the physical signal port S opens the valve.

Basic Assumptions and Limitations

- Fluid inertia is not taken into account.
- The flow passage area is assumed to be equal to the frustum side surface area.

Parameters

Valve stem diameter

The diameter of the valve stem. The default value is 0.01 m.

Seat cone angle

The angle of the valve conical seat. The parameter value must be in the range between 0 and 180 degrees. The default value is 120 degrees.

Initial opening

The initial opening of the valve. The parameter value must be nonnegative. The default value is 0.

Flow discharge coefficient

Semi-empirical parameter for valve capacity characterization. Its value depends on the geometrical properties of the orifice, and usually is provided in textbooks or manufacturer data sheets. The default value is 0.65.

Laminar transition specification

Select how the block transitions between the laminar and turbulent regimes:

- **Pressure ratio** — The transition from laminar to turbulent regime is smooth and depends on the value of the **Laminar flow pressure ratio** parameter. This method provides better simulation robustness.
- **Reynolds number** — The transition from laminar to turbulent regime is assumed to take place when the Reynolds number reaches the value specified by the **Critical Reynolds number** parameter.

Laminar flow pressure ratio

Pressure ratio at which the flow transitions between laminar and turbulent regimes. The default value is 0.999. This parameter is visible only if the **Laminar transition specification** parameter is set to Pressure ratio.

Critical Reynolds number

The maximum Reynolds number for laminar flow. The value of the parameter depends on the orifice geometrical profile. You can find recommendations on the parameter value in hydraulics textbooks. The default value is 10. This parameter is visible only if the **Laminar transition specification** parameter is set to Reynolds number.

Leakage area

The total area of possible leaks in the completely closed valve. The main purpose of the parameter is to maintain numerical integrity of the circuit by preventing a portion of the system from getting isolated after the valve is completely closed. The parameter value must be greater than 0. The default value is $1e-12 \text{ m}^2$.

Global Parameters

Parameters determined by the type of working fluid:

- **Fluid density**
- **Fluid kinematic viscosity**

Use the Hydraulic Fluid block or the Custom Hydraulic Fluid block to specify the fluid properties.

Ports

The block has the following ports:

A

Hydraulic conserving port associated with the valve inlet.

B

Hydraulic conserving port associated with the valve outlet.

S

Physical signal port to control spool displacement.

Extended Capabilities**C/C++ Code Generation**

Generate C and C++ code using Simulink® Coder™.

See Also

Ball Valve | Gate Valve | Needle Valve | Pressure-Compensated Flow Control Valve

Topics

“Upgrading Simscape Fluids Models Containing Hydraulics (Isothermal) Blocks”

Introduced in R2006a

Poppet Valve (IL)

Poppet valve in an isothermal liquid network

Library: Simscape / Fluids / Isothermal Liquid / Valves & Orifices / Flow Control Valves



Description

The Poppet Valve (IL) block models a flow-control valve in an isothermal liquid system. The poppet can either have a cylindrical or ball control member. For ball valves, you can choose between sharp-edged and conical seats. The poppet opens or closes according to the displacement signal at port **S**. A positive signal retracts the poppet and opens the valve.

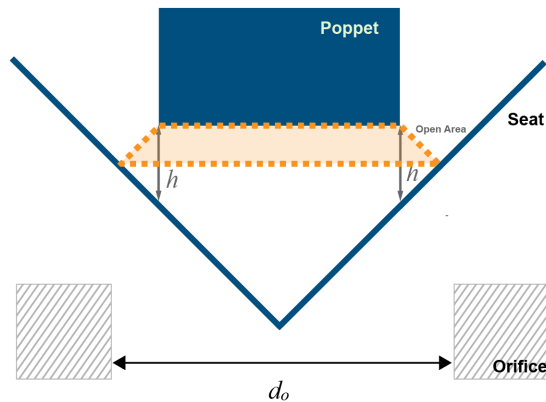

Poppet Valve Schematic

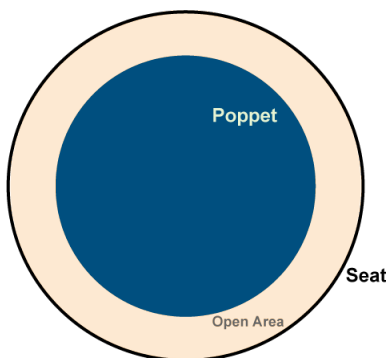

Poppet Valve Top View

Cylindrical Stem Poppet Opening Area

The opening area of the valve is calculated as:

$$A_{open} = \pi h \sin\left(\frac{\theta}{2}\right) \left[d_s + \frac{h}{2} \sin(\theta) \right] + A_{leak},$$

where:

- h is the vertical distance between the outer edge of the cylinder and the seat, indicated in the schematic above.
- θ is the **Seat cone angle**.
- d_s is the **Stem diameter**.
- A_{leak} is the **Leakage area**.

The opening area is bounded by the maximum displacement h_{max} :

$$h_{max} = \frac{d_s \left[\sqrt{1 + \cos\left(\frac{\theta}{2}\right)} - 1 \right]}{\sin(\theta)}.$$

For any stem displacement larger than h_{max} , A_{open} is the sum of the maximum orifice area and the **Leakage area**:

$$A_{open} = \frac{\pi}{4} d_s^2 + A_{leak}.$$

For any combination of the signal at port **S** and the cylinder offset less than 0, the minimum valve area is the **Leakage area**.

Round Ball Poppet Opening Area

Sharp-edged Seat Geometry

The opening area of the valve is calculated as:

$$A_{open, sharp - edged} = \pi r_O \sqrt{(G_{sharp} + h)^2 + r_O^2} \left[1 - \frac{r_B^2}{(G_{sharp} + h)^2 + r_O^2} \right] + A_{leak},$$

where:

- h is the vertical distance between the outer edge of the cylinder and the seat, indicated in the schematic above.
- r_O is the seat orifice radius, calculated from the **Seat orifice diameter**.
- r_B is the radius of the ball, calculated from the **Ball diameter**.
- G_{sharp} is the geometric parameter: $G_{sharp} = \sqrt{r_B^2 - r_O^2}$.
- A_{leak} is the **Leakage area**.

The opening area is bounded by the maximum displacement h_{max} :

$$h_{max} = \sqrt{\frac{2r_B^2 - r_O^2 + r_O \sqrt{r_O^2 + 4r_B^2}}{2}} - G_{sharp}.$$

For any ball displacement larger than h_{max} , A_{open} is the sum of the maximum orifice area and the **Leakage area**:

$$A_{open} = \frac{\pi}{4}d_O^2 + A_{leak}.$$

For any combination of the signal at port **S** and the ball offset that is less than 0, the minimum valve area is the **Leakage area**.

Conical Seat Geometry

The opening area of the valve is calculated as:

$$A_{open, conical} = G_{conical}h + \frac{\pi}{2}\sin(\theta)\sin\left(\frac{\theta}{2}\right)h^2 + A_{leak},$$

where:

- h is the vertical distance between the outer edge of the cylinder and the seat, indicated in the schematic above.
- θ is the **Seat cone angle**.
- $G_{conical}$ is the geometric parameter: $G_{conical} = \pi r_B \sin(\theta)$, where r_B is the ball radius.
- A_{leak} is the **Leakage area**.

The opening area is bounded by the maximum displacement h_{max} :

$$h_{max} = \frac{\sqrt{r_B^2 + \frac{r_O^2}{\cos\left(\frac{\theta}{2}\right)} - r_B}}{\sin\left(\frac{\theta}{2}\right)}.$$

For any ball displacement larger than h_{max} , A_{open} is the sum of the maximum orifice area and the **Leakage area**:

$$A_{open} = \frac{\pi}{4}d_O^2 + A_{leak}.$$

For any combination of the signal at port **S** and the ball offset that is less than 0, the minimum valve area is the **Leakage area**.

Numerically-Smoothed Displacement

At the extremes of the orifice opening range, you can maintain numerical robustness in your simulation by adjusting the block **Smoothing factor**. When the smoothing factor is nonzero, a smoothing function is applied to every calculated displacement, but primarily influences the simulation at the extremes of this range.

The normalized orifice opening is:

$$\hat{h} = \frac{h}{h_{max}}.$$

The **Smoothing factor**, s , is applied to the normalized opening:

$$\hat{h}_{smoothed} = \frac{1}{2} + \frac{1}{2}\sqrt{\hat{h}^2 + \left(\frac{s}{4}\right)^2} - \frac{1}{2}\sqrt{(\hat{h} - 1)^2 + \left(\frac{s}{4}\right)^2}.$$

The smoothed opening is:

$$h_{smoothed} = \hat{h}_{smoothed} h_{max}$$

This smoothed opening is used in the valve opening area, either $A_{open,conical}$ or $A_{open,sharp-edged}$.

Mass Flow Rate Equation

Mass is conserved through the valve:

$$\dot{m}_A + \dot{m}_B = 0.$$

The mass flow rate through the valve is calculated as:

$$\dot{m} = \frac{C_d A_{valve} \sqrt{2\bar{\rho}}}{\sqrt{PR_{loss} \left(1 - \left(\frac{A_{valve}}{A_{port}}\right)^2\right) [\Delta p^2 + \Delta p_{crit}^2]^{1/4}} \Delta p$$

where:

- C_d is the **Discharge coefficient**.
- A_{valve} is the current valve open area.
- A_{port} is the **Cross-sectional area at ports A and B**.
- $\bar{\rho}$ is the average fluid density.
- Δp is the valve pressure difference $p_A - p_B$.

The critical pressure difference, Δp_{crit} , is the pressure differential associated with the **Critical Reynolds number**, Re_{crit} , the flow regime transition point between laminar and turbulent flow:

$$\Delta p_{crit} = \frac{\pi \bar{\rho}}{8 A_{valve}} \left(\frac{\nu Re_{crit}}{C_d} \right)^2.$$

Pressure loss describes the reduction of pressure in the valve due to a decrease in area. PR_{loss} is calculated as:

$$PR_{loss} = \frac{\sqrt{1 - \left(\frac{A_{valve}}{A_{port}}\right)^2 (1 - C_d^2)} - C_d \frac{A_{valve}}{A_{port}}}{\sqrt{1 - \left(\frac{A_{valve}}{A_{port}}\right)^2 (1 - C_d^2)} + C_d \frac{A_{valve}}{A_{port}}}.$$

Pressure recovery describes the positive pressure change in the valve due to an increase in area. If you do not wish to capture this increase in pressure, set the **Pressure recovery** to Off. In this case, PR_{loss} is 1.

Ports

Conserving

A – Liquid port

isothermal liquid

Liquid entry or exit port to the valve.

B – Liquid port

isothermal liquid

Liquid entry or exit port to the valve.

Input**S – Stem displacement, m**

physical signal

Displacement of the valve control member in m, specified as a physical signal..

Parameters**Poppet geometry – Type of poppet**

Cylindrical stem (default) | Round ball

Type of poppet. You can choose either a cylindrical or ball-shaped control member.

Valve seat specification – Geometry of valve seat

Sharp-edged (default) | Conical

Geometry of valve seat. This parameter is used for calculating the open area between the poppet and seat.

DependenciesTo enable this parameter, set **Poppet geometry** to Round ball.**Ball diameter – Diameter of ball control member**

0.01 m (default) | positive scalar

Diameter of the ball control member.

DependenciesTo enable this parameter, set **Poppet geometry** to Round ball.**Seat orifice diameter – Seat orifice diameter**

7e-3 m (default) | positive scalar

Seat orifice diameter.

DependenciesTo enable this parameter, set **Poppet geometry** to Round ball.**Stem diameter – Diameter of cylindrical stem**

0.01 m (default) | positive scalar

Diameter of the cylindrical stem.

DependenciesTo enable this parameter, set **Poppet geometry** to Cylindrical stem.

Seat cone angle – Angle of seat opening

120 deg (default) | positive scalar

Angle of the seat opening.

Dependencies

To enable this parameter, set either:

- **Poppet geometry** to `Cylindrical stem`
- **Poppet geometry** to `Round ball` and **Valve seat specification** to `Conical`

Poppet position when in the seat – Control member offset

0 m (default) | positive scalar

Poppet offset when valve is closed. A positive, nonzero value indicates a partially open valve. A negative, nonzero value indicates an overlapped valve that remains closed for an initial displacement set by the physical signal at port **S**.

Leakage area – Gap area when in fully closed position1e-10 m² (default) | positive scalar

Sum of all gaps when the valve is in the fully closed position. Any area smaller than this value is saturated to the specified leakage area. This contributes to numerical stability by maintaining continuity in the flow.

Cross-sectional area at ports A and B – Area at conserving portsinf m² (default) | positive scalar

Areas at the entry and exit ports **A** and **B**, which are used in the pressure-flow rate equation that determines the mass flow rate through the valve.

Discharge coefficient – Discharge coefficient

0.64 (default) | positive scalar

Correction factor that accounts for discharge losses in theoretical flows.

Critical Reynolds number – Upper Reynolds number limit for laminar flow

150 (default) | positive scalar

Upper Reynolds number limit for laminar flow through the orifice.

Smoothing factor – Numerical smoothing factor

0.01 (default) | positive scalar in the range [0,1]

Continuous smoothing factor that introduces a layer of gradual change to the flow response when the valve is in near-open or near-closed positions. Set this value to a nonzero value less than one to increase the stability of your simulation in these regimes.

Pressure recovery – Whether to account for pressure increase in area expansions

Off (default) | On

Whether to account for pressure increase when fluid flows from a region of smaller cross-sectional area to a region of larger cross-sectional area.

See Also

Ball Valve (G) | Ball Valve (TL) | Needle Valve (IL) | Gate Valve (IL)

Introduced in R2020a

Porting Plate Variable Orifice

Variable orifice between piston and porting plate



Library

Pumps and Motors

Description

Porting plate is a key element of axial-piston machines. Its objective is to provide communication between pistons and pump ports during the rotor, or cylinder block, rotation. The porting plate is equipped with two crescent-shaped slots, one of which is connected to the intake port while the other is channeled to the discharge port. The pistons are carried along the porting plate slots, thus periodically connecting the piston to either the intake or the discharge port of the machine.

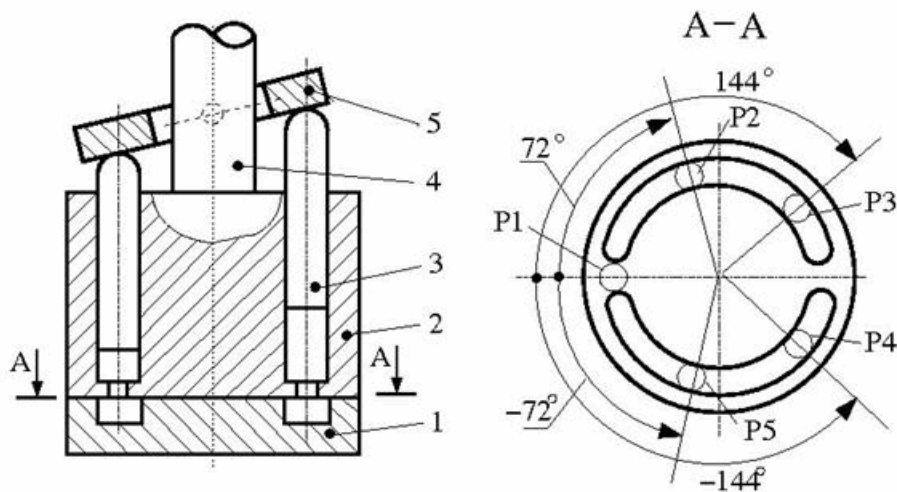

The preceding diagram shows an axial-piston machine with five pistons, where:

- 1 Porting plate
- 2 Rotor
- 3 Piston
- 4 Driving shaft
- 5 Swash plate

During rotor rotation, every piston gets connected to one of the porting slots. These piston connections, modeled as variable orifices, are reflected in the schematic model of a piston, shown in the following illustration.

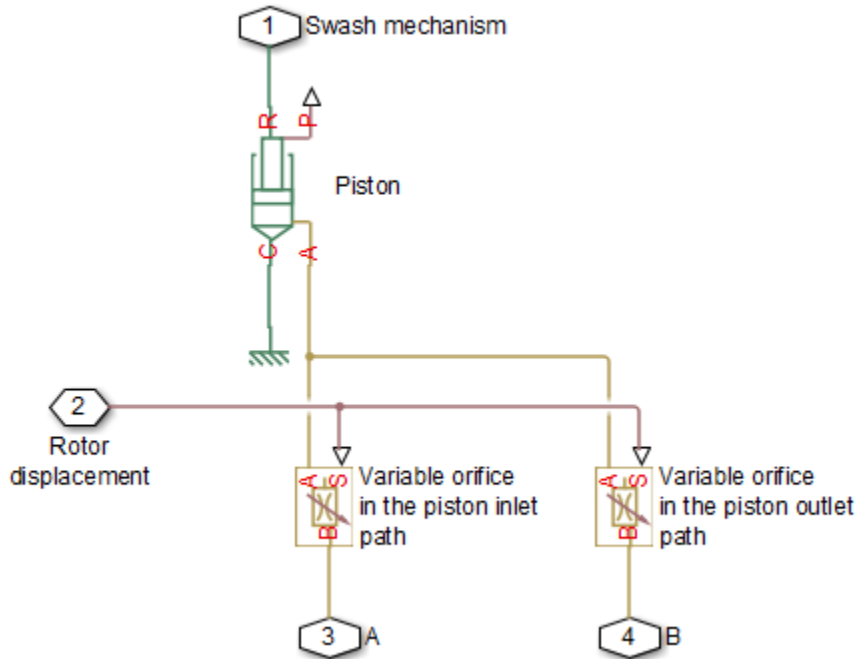

The Porting Plate Variable Orifice block is a model of a variable orifice created between the piston chamber and a slot on a porting plate. Two Porting Plate Variable Orifice blocks are necessary in the model of a piston, to simulate connection to the intake and the discharge port, respectively.

The calculation diagram of the porting plate variable orifice is shown in the next illustration.

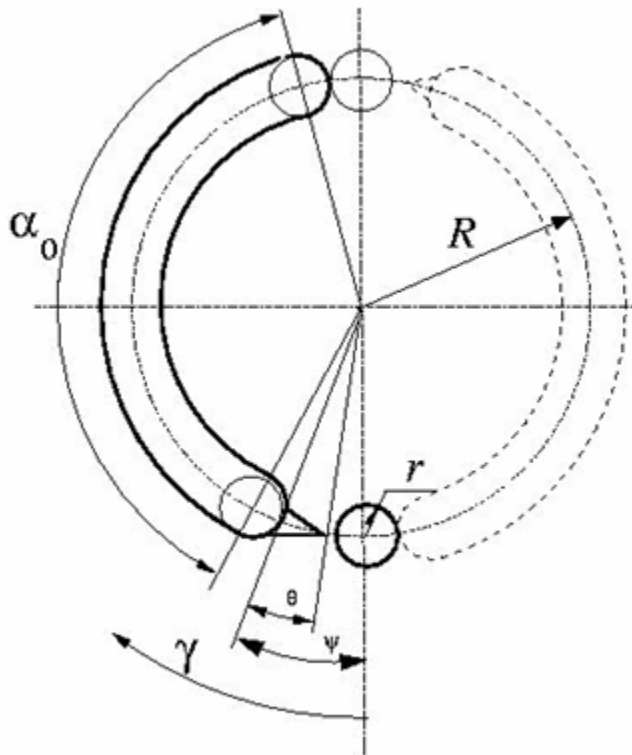

The model assumes that the slot is shifted by a pressure carryover angle ψ from the reference point in the direction of orifice rotation. Generally, $r/R \leq \psi \leq 3 \cdot r/R$, where r is the orifice radius and R is the piston pitch radius. A small triangular-shaped transition slot is placed at the beginning of the major slot, to avoid sudden pressure change. To avoid direct connection between the intake and discharge slots, the transition slot angle θ must be less than $\psi - r/R$. The transition slot area is assumed to be linearly dependent on the rotation angle and characterized by its maximum area. There are six distinctive angles defining the relationship between the rotation angle γ and the orifice opening, as listed in the following table.

No	Nomenclature	Value	Description
1	γ_1	$\psi - \theta - r/R$	Opening of transition slot starts.
2	γ_2	$\psi - r/R$	Opening of the major slot starts. The orifice contacts with the transition slot.
3	γ_3	$\psi + r/R$	Major slot full opening starts.
4	γ_4	$\psi + r/R + 0.01$	Transition slot ends.
5	γ_5	$\pi - 2 \cdot r/R$	Major slot full opening ends.
6	γ_6	π	Major slot opening ends.

The variable orifice is fully opened in the α_0 region

$$\psi + r/R \leq \gamma \leq \pi - 2 \cdot r/R$$

where γ is the rotation angle.

The orifice area is computed with the following equations:

$$\begin{aligned}
 A &= A_{leak} && \text{for } \gamma_6 < \gamma \leq \gamma_1 \\
 A &= G \cdot (\gamma - \gamma_1) + A_{leak} && \text{for } \gamma_1 < \gamma \leq \gamma_2 \\
 A &= A_{tr} + r^2(\beta - \sin\beta) + A_{leak} && \text{for } \gamma_2 < \gamma \leq \gamma_3 \\
 A &= A_{tr} \cdot (1 - 100 \cdot (\gamma - \gamma_3)) + \pi \cdot r^2 + A_{leak} && \text{for } \gamma_3 < \gamma \leq \gamma_4 \\
 A &= \pi \cdot r^2 + A_{leak} && \text{for } \gamma_4 < \gamma \leq \gamma_5 \\
 A &= r^2(\beta - \sin\beta) + A_{leak} && \text{for } \gamma_5 < \gamma \leq \gamma_6 \\
 \beta &= \begin{cases} 2 \cdot \arccos(R/r \cdot \sin(0.5 \cdot (\gamma_3 - \gamma))) & \text{for } \gamma_2 < \gamma \leq \gamma_3 \\ 2 \cdot \arccos(R/r \cdot \sin(0.5 \cdot (2 \cdot r/R + \gamma - \pi))) & \text{for } \gamma_5 < \gamma \leq \gamma_6 \end{cases}
 \end{aligned}$$

where

A	Orifice area
A_{tr}	Transition slot maximum area
A_{leak}	Closed orifice leakage area

After the area has been determined, the flow rate through the orifice is computed with the following equations:

$$q = C_D \cdot A \sqrt{\frac{2}{\rho}} \cdot \frac{p}{(p^2 + p_{cr}^2)^{1/4}}$$

$$\Delta p = p_A - p_B,$$

$$p_{cr} = \frac{\rho}{2} \left(\frac{Re_{cr} \cdot \nu}{C_D \cdot D_H} \right)^2$$

$$D_H = \sqrt{\frac{4A}{\pi}}$$

where

q	Flow rate
p	Pressure differential
p_A, p_B	Gauge pressures at the block terminals
C_D	Flow discharge coefficient
D_H	Orifice hydraulic diameter
ρ	Fluid density
ν	Fluid kinematic viscosity
p_{cr}	Minimum pressure for turbulent flow
Re_{cr}	Critical Reynolds number

The Porting Plate Variable Orifice block model is essentially a building block intended for use in various piston machines. The model accounts for the flow regime by computing the Reynolds number and comparing it with its critical value. No inertial effects are considered in the model.

Connections A and B are hydraulic conserving ports associated with the inlet and outlet of the orifice. Connection G is a physical signal port associated with the input signal for the cylinder block angle. The input signal at port G is treated as an angle, in radians, therefore it is essential that the input signal representing angular displacement is kept within the range from 0 to 2π . Connect port G to the output port of an Angle Sensor block to meet this requirement.

The flow rate is considered positive if it flows from A to B. At initial position, the orifice is assumed to be shifted by the pressure carryover angle from the slot. When the block rotates in the positive direction, the orifice starts opening. To adjust the initial position of the orifice with respect to the slot, use the **Phase angle** parameter.

Basic Assumptions and Limitations

- The model accounts for the viscous friction in the piston-plate contact.
- No inertial effects are considered.
- The plate angular displacements are considered to be small.
- The joint between the piston and the plate permanently maintains contact between the piston and the plate.

Parameters

Piston pitch radius

The radius of the pitch circle where the pistons are located. The parameter must be greater than zero. The default value is 0.05 m.

Orifice diameter

The diameter of the orifice at the bottom of the piston chamber. The parameter must be greater than zero. The default value is 0.005 m.

Pressure carryover angle

The angle introduced between to slot and the orifice to avoid abrupt pressure change and decrease leakage. This angle is marked ψ in the preceding calculation diagram. The angle is expected to be in the range $r/R \leq \psi \leq 3 \cdot r/R$, where r is the orifice radius and R is the piston pitch radius. The default value is 0.06 rad.

Phase angle

This parameter sets the orifice initial angular position with respect to the slot. The default value is 0, which means that the orifice is shifted by the pressure carryover angle from the slot.

Transition slot angle

The angle covered by a small, triangular-shaped transition slot placed before the major slot to avoid sudden pressure change, as shown in the preceding calculation diagram. To avoid direct connection between the intake and discharge slots, the transition slot angle θ must be less than $\psi - r/R$. The default value is 0.01 rad.

Transition slot maximum area

The maximum cross-sectional area of the transition slot. The slot area is assumed to be linearly-dependent on the rotation angle and reaches its maximum when the orifice approaches the major slot. The default value is $1e-6$ m.

Flow discharge coefficient

Semi-empirical parameter for orifice capacity characterization. Its value depends on the geometrical properties of the orifice, and usually is provided in textbooks or manufacturer data sheets. The default value is 0.6.

Critical Reynolds number

The maximum Reynolds number for laminar flow. The transition from laminar to turbulent regime is assumed to take place when the Reynolds number reaches this value. The value of the parameter depends on the orifice geometrical profile. You can find recommendations on the parameter value in hydraulics textbooks. The default value is 12, which corresponds to a round orifice in thin material with sharp edges.

Leakage area

The total area of possible leaks in the completely closed orifice. The main purpose of the parameter is to maintain numerical integrity of the circuit by preventing a portion of the system from getting isolated after the valve is completely closed. The parameter value must be greater than 0. The default value is $1e-9 \text{ m}^2$.

Global Parameters

Parameters determined by the type of working fluid:

- **Fluid density**
- **Fluid kinematic viscosity**

Use the Hydraulic Fluid block or the Custom Hydraulic Fluid block to specify the fluid properties.

Ports

The block has the following ports:

A

Hydraulic conserving port associated with the orifice inlet.

B

Hydraulic conserving port associated with the orifice outlet.

G

Physical signal input port that conveys the angular position of the orifice to the block. The signal applied to the port is treated as an angle, in radians, and must be in the range between 0 and 2π .

Examples

The “Hydraulic Axial-Piston Pump with Load-Sensing and Pressure-Limiting Control” example models a test rig designed to investigate interaction between an axial-piston pump and a typical control unit, simultaneously performing the load-sensing and pressure-limiting functions. To assure required accuracy, the model of the pump must account for such features as interaction between pistons, swash plate, and porting plate, which makes it necessary to build a detailed pump model.

Extended Capabilities

C/C++ Code Generation

Generate C and C++ code using Simulink® Coder™.

See Also

Angle Sensor | Swash Plate

Topics

“Upgrading Simscape Fluids Models Containing Hydraulics (Isothermal) Blocks”

Introduced in R2011a

Pressure-Compensated 3-Way Flow Control Valve

Hydraulic pressure compensating 3-way valve



Library

Flow Control Valves

Description

The Pressure-Compensated 3-Way Flow Control Valve block represents a 3-way pressure-compensated flow control valve as a data-sheet-based model. The valve model includes a variable orifice and a normally closed pressure-control valve, connected in parallel with the orifice. The purpose of the pressure-control valve is to maintain a preset pressure differential across the orifice by diverting some flow from port A to the tank (port R) if the pressure differential exceeds the preset value. Port C controls the orifice opening, as shown in the following figure.

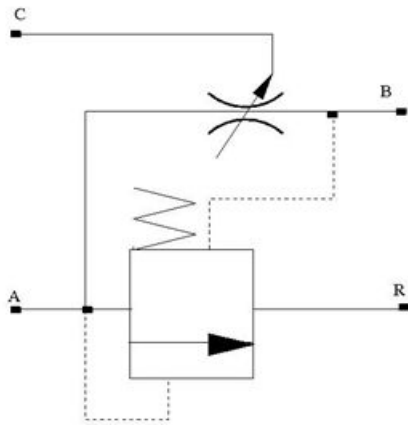

Depending on data listed in the manufacturer's catalogs or data sheets for your particular valve, you can choose one of the following model parameterization options:

- By maximum area and opening — Use this option if the data sheet provides only the orifice maximum area and the control member maximum stroke.
- By area vs. opening table — Use this option if the catalog or data sheet provides a table of the orifice passage area based on the control member displacement $A=A(h)$.

In the first case, the passage area is assumed to be linearly dependent on the control member displacement, that is, the orifice is assumed to be closed if the initial orifice opening is set to zero and the control member position also equals zero. The maximum orifice opening takes place at the

maximum displacement. In the second case, the passage area is determined by one-dimensional interpolation from the table $A=A(h)$.

The pressure-control valve representation does not account for inertia, friction, or hydraulic forces. The valve has the following area-pressure differential relationship:

$$A_{pc} = \begin{cases} A_{leak} & \text{for } p < p_{set} \\ (p - p_{set}) \frac{A_{max_pc}}{p_{reg}} & \text{for } p_{set} \leq p \leq (p_{set} + p_{reg}) \\ A_{max_pc} & \text{for } p > (p_{set} + p_{reg}) \end{cases}$$

where

A_{pc}	Pressure-control valve passage area
p	Pressure differential across the orifice
p_{set}	Preset pressure differential
p_{reg}	Regulation range
A_{max_pc}	Pressure-control valve maximum area
A_{leak}	Closed orifice leakage area for pressure compensator

Both for the variable orifice and the pressure compensator, a small leakage area is assumed to exist even after the orifice is completely closed. Physically, it represents a possible clearance in the closed valve, but the main purpose of the parameter is to maintain numerical integrity of the circuit by preventing a portion of the system from getting isolated after the valve is completely closed. An isolated or “hanging” part of the system could affect computational efficiency and even cause failure of computation.

After the area has been determined, the block computes the flow rate for both the orifice and the pressure compensator according to the following equations:

$$q = C_D \cdot A \sqrt{\frac{2}{\rho}} \cdot \frac{p}{(p^2 + p_{cr}^2)^{1/4}}$$

$$A = \begin{cases} A_{pc} & \text{for pressure compensator} \\ A_{or} & \text{for variable orifice} \end{cases}$$

$$A_{pc} = \begin{cases} h \cdot A_{max}/h_{max} + A_{leak} & \text{for } h > 0 \\ A_{leak} & \text{for } h < = 0 \end{cases}$$

$$h = x_0 + x$$

$$p = \begin{cases} p_A - p_R & \text{for pressure compensator} \\ p_A - p_B & \text{for variable orifice} \end{cases}$$

$$p_{cr} = \frac{\rho}{2} \left(\frac{Re_{cr} \cdot \nu}{C_D \cdot D_H} \right)^2$$

$$D_H = \sqrt{\frac{4A}{\pi}}$$

where

q	Flow rate
p	Pressure differential
p_A, p_B, p_R	Gauge pressures at the block terminals
C_D	Flow discharge coefficient
A	Instantaneous orifice passage area
A_{\max}	Orifice maximum area
A_{leak}	Closed orifice leakage area
h_{\max}	Control member maximum displacement
x_0	Initial opening
x	Control member displacement from initial position
h	Orifice opening
ρ	Fluid density
ν	Fluid kinematic viscosity
p_{cr}	Minimum pressure for turbulent flow
Re_{cr}	Critical Reynolds number
D_H	Instantaneous orifice hydraulic diameter

Connections A, B, and R are the conserving hydraulic ports associated with the valve inlet, outlet, and return, respectively. Connection C is a physical signal port through which the orifice opening is controlled. The block positive direction is from port A to port B. Positive signal at port C opens the valve.

Assumptions and Limitations

Fluid inertia and pressure compensator loading are not taken into account.

Parameters

- “Variable Orifice Tab” on page 1-1231
- “Pressure Compensator Tab” on page 1-1233

Variable Orifice Tab

Orifice parameterization

Select one of the following methods for specifying the orifice:

- **By maximum opening and area** — Provide values for the maximum orifice area and the maximum orifice opening. The passage area is linearly dependent on the control member displacement, that is, the orifice is closed at the initial position of the control member (zero displacement), and the maximum opening takes place at the maximum displacement. This is the default method.
- **By orifice area vs. orifice opening table** — Provide tabulated data of orifice openings and corresponding orifice areas. The passage area is determined by one-dimensional table lookup. You have a choice of two interpolation methods and two extrapolation methods.

Orifice maximum area

The area of a fully opened orifice. The parameter value must be greater than zero. The default value is $1e-4 \text{ m}^2$. This parameter is used if **Orifice parameterization** is set to **By maximum opening and area**.

Orifice maximum opening

The maximum displacement of the control member. The parameter value must be greater than zero. The default value is 0.005 m . This parameter is used if **Orifice parameterization** is set to **By maximum opening and area**.

Tabulated orifice openings

Vector of input values for orifice openings, specified as a one-dimensional array. The input values vector must be strictly increasing. The values can be nonuniformly spaced. The minimum number of values depends on the interpolation method: you must provide at least two values for linear interpolation, at least three values for smooth interpolation. The default values, in mm, are $[-6, 0, 1, 3, 6, 9, 15]$. This parameter is used if **Orifice parameterization** is set to **By orifice area vs. orifice opening table**. **Tabulated orifice openings** values will be used together with **Tabulated orifice area** values for one-dimensional table lookup.

Tabulated orifice area

Vector of orifice areas, specified as a one-dimensional array. The vector must be the same size as the orifice openings vector. All the values must be positive. The default values, in cm^2 , are $[1e-7, 1e-6, 0.08, 0.145, 0.96, 1, 1.001]$. This parameter is used if **Orifice parameterization** is set to **By orifice area vs. orifice opening table**.

Interpolation method

This parameter is used if **Orifice parameterization** is set to **By orifice area vs. orifice opening table**. Select one of the following interpolation methods for approximating the output value when the input value is between two consecutive grid points:

- **Linear** — Select this option to get the best performance.
- **Smooth** — Select this option to produce a continuous curve with continuous first-order derivatives.

For more information on interpolation algorithms, see the PS Lookup Table (1D) block reference page.

Extrapolation method

This parameter is used if **Orifice parameterization** is set to **By orifice area vs. orifice opening table**. Select one of the following extrapolation methods for determining the output value when the input value is outside the range specified in the argument list:

- **Linear** — Select this option to produce a curve with continuous first-order derivatives in the extrapolation region and at the boundary with the interpolation region.
- **Nearest** — Select this option to produce an extrapolation that does not go above the highest point in the data or below the lowest point in the data.

For more information on extrapolation algorithms, see the PS Lookup Table (1D) block reference page.

Orifice initial opening

Orifice initial opening. The parameter can be positive (underlapped orifice), negative (overlapped orifice), or 0 for zero-lap configuration. The default value is 0.

Orifice flow discharge coefficient

Semi-empirical coefficient that is used in the computation of flow rate through the orifice. Its value depends on the geometrical properties of the orifice and usually is provided in textbooks or manufacturer data sheets. The default value is 0.6.

Orifice laminar transition specification

Select how the block transitions between the laminar and turbulent regimes:

- **Pressure ratio** — The transition from laminar to turbulent regime is smooth and depends on the value of the **Orifice laminar flow pressure ratio** parameter. This method provides better simulation robustness.
- **Reynolds number** — The transition from laminar to turbulent regime is assumed to take place when the Reynolds number reaches the value specified by the **Orifice critical Reynolds number** parameter.

Orifice laminar flow pressure ratio

Pressure ratio at which the flow transitions between laminar and turbulent regimes. The default value is 0.999. This parameter is visible only if the **Orifice laminar transition specification** parameter is set to **Pressure ratio**.

Orifice critical Reynolds number

The maximum Reynolds number for laminar flow. The value of the parameter depends on the orifice geometrical profile. You can find recommendations on the parameter value in hydraulics textbooks. The default value is 12. This parameter is visible only if the **Orifice laminar transition specification** parameter is set to **Reynolds number**.

Orifice leakage area

The total area of possible leaks in the completely closed orifice. The main purpose of the parameter is to maintain numerical integrity of the circuit by preventing a portion of the system from getting isolated after the valve is completely closed. The parameter value must be greater than 0. The default value is $1e-9 \text{ m}^2$.

Pressure Compensator Tab**Pressure differential across orifice setting**

Pressure difference that must be maintained across the variable orifice by the pressure compensator. The default value is 6e5 Pa.

Pressure differential regulation range

Pressure increase over the preset level needed to fully open the pressure compensator orifice. The lower the value of the range, the higher the valve sensitivity. The default value is 0.5e5 Pa.

Pressure compensator maximum area

The area of a fully opened pressure compensator. The parameter value must be greater than zero. The default value is $1e-4 \text{ m}^2$.

Pressure compensator flow discharge coefficient

Semi-empirical coefficient that is used in the computation of flow rate through the pressure compensator. The default value is 0.6.

Pressure compensator laminar transition specification

Select how the block transitions between the laminar and turbulent regimes:

- **Pressure ratio** — The transition from laminar to turbulent regime is smooth and depends on the value of the **Pressure compensator laminar flow pressure ratio** parameter. This method provides better simulation robustness.
- **Reynolds number** — The transition from laminar to turbulent regime is assumed to take place when the Reynolds number reaches the value specified by the **Pressure compensator critical Reynolds number** parameter.

Pressure compensator laminar flow pressure ratio

Pressure ratio at which the flow transitions between laminar and turbulent regimes. The default value is 0.999. This parameter is visible only if the **Pressure compensator laminar transition specification** parameter is set to **Pressure ratio**.

Pressure compensator critical Reynolds number

The maximum Reynolds number for laminar flow. The value of the parameter depends on the orifice geometrical profile. You can find recommendations on the parameter value in hydraulics textbooks. The default value is 12. This parameter is visible only if the **Pressure compensator laminar transition specification** parameter is set to **Reynolds number**.

Pressure compensator leakage area

The total area of possible leaks in the completely closed orifice. Must be greater than 0. The main purpose of the parameter is to maintain numerical integrity of the circuit by preventing a portion of the system from getting isolated after the valve is completely closed. The default value is $1e-9$ m².

Restricted Parameters

When your model is in Restricted editing mode, you cannot modify the following parameters:

- **Model parameterization**
- **Interpolation method**
- **Extrapolation method**
- **Orifice laminar transition specification**
- **Pressure compensator laminar transition specification**

All other block parameters are available for modification. The actual set of modifiable block parameters depends on the value of the **Model parameterization** parameter at the time the model entered Restricted mode.

Global Parameters

Parameters determined by the type of working fluid:

- **Fluid density**
- **Fluid kinematic viscosity**

Use the Hydraulic Fluid block or the Custom Hydraulic Fluid block to specify the fluid properties.

Ports

The block has the following ports:

- A Hydraulic conserving port associated with the valve inlet.
- B Hydraulic conserving port associated with the valve outlet.
- R Hydraulic conserving port that connects with the tank.
- C Physical signal control port.

Extended Capabilities

C/C++ Code Generation

Generate C and C++ code using Simulink® Coder™.

See Also

Pressure-Compensated Flow Control Valve

Topics

“Upgrading Simscape Fluids Models Containing Hydraulics (Isothermal) Blocks”

Introduced in R2013b

Pressure-Compensated 3-Way Flow Control Valve (IL)

3-way flow control in an isothermal liquid system

Library: Simscape / Fluids / Isothermal Liquid / Valves & Orifices / Flow Control Valves

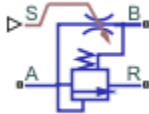

Description

The Pressure-Compensated 3-Way Flow Control Valve (IL) block models constant-pressure flow control. When the control pressure, $p_A - p_B$, meets or exceeds the **Set orifice pressure differential**, the relief component of the underlying compensator valve opens to maintain the pressure in the block.

The flow control valve opening and closing is controlled by a physical signal received at port **S**, which determines the area of the underlying orifice block. A positive signal opens the valve. Port **R** vents liquid to another part of your network.

For pressure-compensated flow control without venting, see the Pressure-Compensated Flow Control Valve (IL) block.

Orifice Parameterization

You can choose the valve model with the **Orifice parameterization** setting:

- **Linear - area vs. control member position** is an analytical formulation that assumes the valve opening area and the valve control member are related linearly.
- **Tabulated data - Area vs. control member position** is a user-supplied data sheet that relates orifice opening area and the control member position. The block queries between data points with linear interpolation and uses nearest extrapolation for points beyond the table boundaries.
- **Tabulated data - Volumetric flow rate vs. control member position and pressure drop** is a user-supplied data sheet that relates the control member position, orifice pressure drop, and orifice volumetric flow rate. The block queries between data points with linear interpolation and uses a nearest extrapolation for points beyond the table boundaries.

Numerically-Smoothed Area and Pressure

At the extremes of the orifice area and valve pressure range, you can maintain numerical robustness in your simulation by tuning the block **Smoothing factor** to a nonzero value less than 1. A smoothing function is applied to all calculated areas and pressures, but primarily influences the simulation at the extremes of these ranges.

The normalized orifice area is calculated as:

$$\widehat{A} = \frac{(A - A_{leak})}{(A_{max} - A_{leak})}.$$

where:

- A_{leak} is the **Leakage area**.
- A_{max} is the cushion **Maximum orifice area**.

The **Smoothing factor**, f , is applied to the normalized area:

$$\widehat{A}_{smoothed} = \frac{1}{2} + \frac{1}{2}\sqrt{\widehat{A}^2 + \left(\frac{f}{4}\right)^2} - \frac{1}{2}\sqrt{(\widehat{A} - 1)^2 + \left(\frac{f}{4}\right)^2}.$$

The smoothed orifice area is:

$$A_{smoothed} = \widehat{A}_{smoothed}(A_{max} - A_{leak}) + A_{leak}.$$

Similarly, the normalized valve pressure is:

$$\widehat{p} = \frac{(p - p_{set})}{(p_{max} - p_{set})}.$$

where:

- p_{set} is the **Set orifice pressure differential**.
- p_{max} is the sum of the **Set orifice pressure differential** and the **Pressure compensator valve regulation range**.

Smoothing applied to the normalized pressure is:

$$\widehat{p}_{smoothed} = \frac{1}{2} + \frac{1}{2}\sqrt{\widehat{p}^2 + \left(\frac{f}{4}\right)^2} - \frac{1}{2}\sqrt{(\widehat{p} - 1)^2 + \left(\frac{f}{4}\right)^2},$$

and the smoothed pressure is:

$$p_{smoothed} = \widehat{p}_{smoothed}(p_{max} - p_{set}) + p_{set}.$$

Block Schematic

The Pressure-Compensated 3-Way Flow Control Valve (IL) is constructed from the Pressure Compensator Valve (IL) and Orifice (IL) blocks.

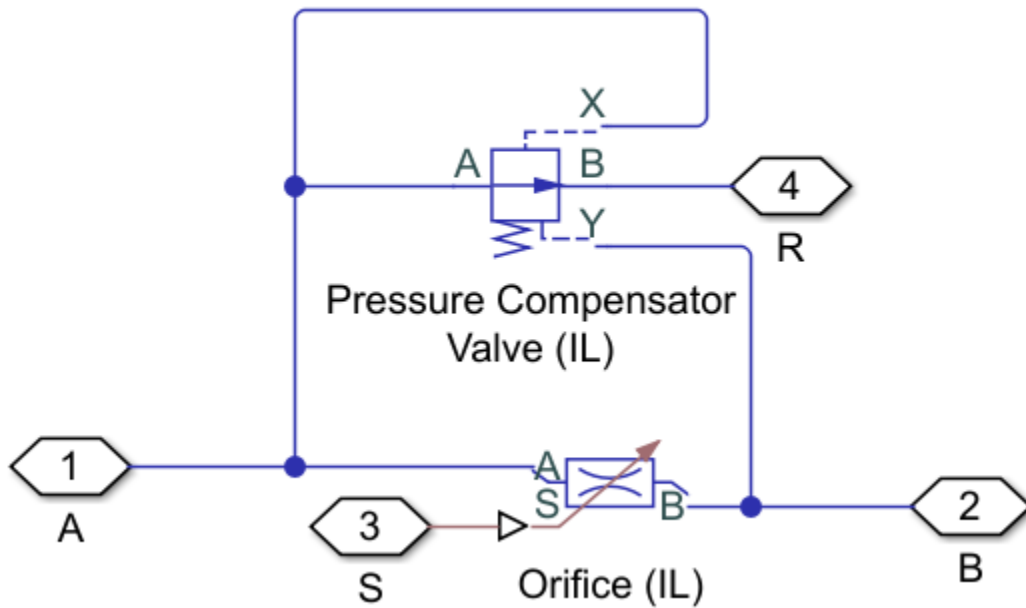

Three-Way Flow Control Valve Schematic

Ports

Conserving

A – Valve liquid port
isothermal liquid

Liquid entry or exit port to the three-way valve.

B – Orifice liquid port
isothermal liquid

Liquid entry or exit port to the orifice.

R – Reducing valve liquid port
isothermal liquid

Liquid exit port from the reducing valve.

Input

S – Physical signal, in m
physical signal

Orifice opening in m, set as a physical signal.

Parameters

Orifice parameterization — Method of modeling orifice opening

Linear - area vs. control member position (default) | Tabulated data - Area vs. control member position | Tabulated data - Volumetric flow rate vs. control member position and pressure drop

Method of modeling the opening of the orifice. The opening is either parametrized linearly, which correlates the opening area to the control member position; by user-supplied data that correlate the orifice opening area to the control member position; or by an array of data that correlates the valve flow rate to the control member position and valve pressure drop.

Control member position at closed orifice — Control member offset

0 m (default) | scalar

Control member offset when the orifice is fully open. A positive, nonzero value indicates a partially closed orifice. A negative, nonzero value indicates an overlapped orifice that remains open for an initial displacement set by the physical signal at port S.

Control member travel between closed and opened orifice — Maximum control member stroke

5e-3 m (default) | positive scalar

Control member stroke that fully opens the orifice.

Dependencies

To enable this parameter, set **Orifice parameterization** to Linear - area vs. control member position.

Maximum orifice area — Maximum orifice cross-sectional area

8e-5 m² (default) | positive scalar

Cross-sectional area of the orifice in its fully open position. This parameter is used as an upper limit for area-pressure calculations during the simulation.

Dependencies

To enable this parameter, set **Orifice parameterization** to Linear - area vs. control member position.

Control member position vector — Vector of opening position

[0, .002, .007] m (default) | 1-by-n vector

Vector of orifice opening distances for the tabular parameterization of the orifice opening area. The vector elements must correspond one-to-one with the elements in the **Orifice area vector** parameter. The elements are listed in ascending order and the first element must be 0. Linear interpolation is employed between table data points.

Dependencies

To enable this parameter, set **Orifice parameterization** to Tabulated data - Area vs. control member position.

Orifice area vector — Vector of opening areas

[1e-09, 4e-09, 1e-05] m² (default) | 1-by-n vector

Vector of valve opening areas for the tabular parameterization of the valve opening area. The vector elements must correspond one-to-one with the elements in the **Control member position vector** parameter. The elements are listed in ascending order and must be greater than 0.

Dependencies

To enable this parameter, set **Orifice parameterization** to Tabulated data - Area vs. control member position.

Control member position vector, **s** — Vector of control member positions

[0, .002, .004, .007, .017] m (default) | 1-by-*n* vector

Vector of control member positions for the tabular parameterization of the volumetric flow rate. The control member position vector forms an independent axis with the **Pressure drop vector, dp** parameter for the 3-D dependent **Volumetric flow rate table, q(s,dp)** parameter. A positive displacement corresponds to valve opening. The values are listed in ascending order and the first element must be 0. Linear interpolation is employed between table data points.

Dependencies

To enable this parameter, set **Orifice parameterization** to Volumetric flow rate vs. control member position and pressure drop.

Pressure drop vector, **dp** — Vector of pressure differential values

[.3, .5, .7] MPa (default) | 1-by-*n* vector

Vector of valve opening areas for the tabular parameterization of the valve opening area. The pressure drop vector forms an independent axis with the **Control member position vector, s** parameter for the 3-D dependent **Volumetric flow rate table, q(s,dp)** parameter. The values are listed in ascending order and must be greater than 0. Linear interpolation is employed between table data points.

Dependencies

To enable this parameter, set **Orifice parameterization** to Volumetric flow rate vs. control member position and pressure drop.

Volumetric flow rate table, **q(s,dp)** — Array of volumetric flow rate values

[1.7e-05, 2e-05, 2.6e-05; .0035, .0045, .0053; .7, .9, 1.06; 1.96, 2.5, 3; 6, 7.7, 9.13] .* 1e-3 m³/s (default) | *M*-by-*N* array

Array of volumetric flow rates based on independent values of pressure drop and spool travel distance. *M* and *N* are the sizes of the corresponding vectors:

- *M* is the number of elements in the **Pressure drop vector, dp** parameter.
- *N* is the number of elements in the **Control member position vector, s** parameter.

Dependencies

To enable this parameter, set **Orifice parameterization** to Volumetric flow rate vs. control member position and pressure drop.

Set orifice pressure differential — Threshold for compensator valve operation

0.6 MPa (default) | positive scalar

Magnitude of pressure differential that triggers valve opening or closing.

Pressure compensator valve regulation range — Area of the fully opened pressure compensator valve

1e-4 m² (default) | positive scalar

Cross-sectional area of the valve in its fully open position. This parameter is used as an upper limit for area-pressure calculations during the simulation.

Pressure compensator valve maximum area — Pressure operational region of the pressure compensating valve

0.1 MPa (default) | scalar

Operational pressure range of the valve. The pressure regulation range lies between the **Set orifice pressure differential** and the maximum valve operating pressure.

Leakage area — Gap area when in fully closed position

1e-10 m² (default) | positive scalar

Sum of all gaps when the valve is in the fully closed position. Any area smaller than this value is maintained at the specified leakage area. This contributes to numerical stability by maintaining continuity in the flow.

Discharge coefficient — Discharge coefficient

0.64 (default) | positive scalar

Correction factor that accounts for discharge losses in theoretical flows.

Critical Reynolds number — Upper Reynolds number limit for laminar flow

150 (default) | positive scalar

Upper Reynolds number limit for laminar flow through the valve.

Smoothing factor — Numerical smoothing factor

0.01 (default) | positive scalar in the range [0,1]

Continuous smoothing factor that introduces a layer of gradual change to the flow response when the valve is in near-open or near-closed positions. Set this value to a nonzero value less than one to increase the stability of your simulation in these regimes.

See Also

Pressure-Compensated Flow Control Valve (IL) | Pressure Compensator Valve (IL) | Pressure-Reducing 3-Way Valve (IL) | Shuttle Valve (IL) | Orifice (IL)

Introduced in R2020a

Pressure-Compensated Flow Control Valve

Hydraulic pressure compensating valve



Library

Flow Control Valves

Description

The Pressure-Compensated Flow Control Valve block represents a pressure-compensated flow control valve as a data-sheet-based model. This flow control valve is composed of a Pressure Compensator valve block and a Variable Orifice block.

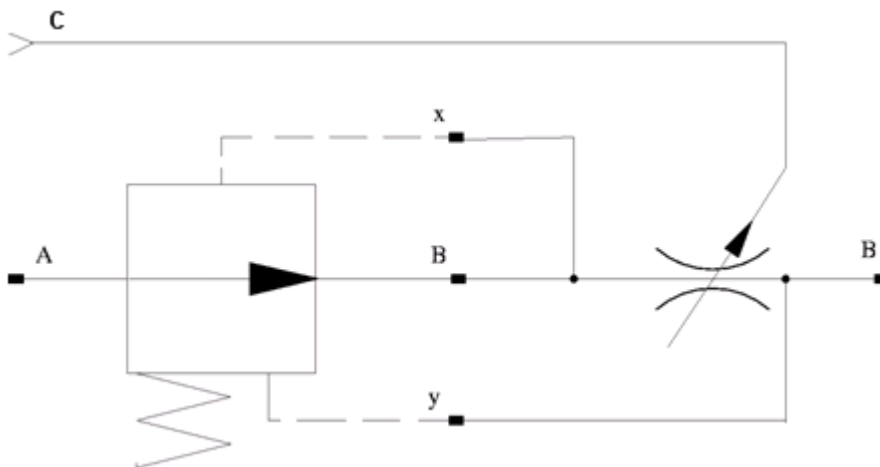

Depending on data listed in the manufacturer's catalogs or data sheets for your particular valve, you can choose one of the following model parameterization options:

- **By maximum area and opening** — Use this option if the data sheet provides only the orifice maximum area and the control member maximum stroke.
- **By area vs. opening table** — Use this option if the catalog or data sheet provides a table of the orifice passage area based on the control member displacement $A=A(h)$.

In the first case, the passage area is assumed to be linearly dependent on the control member displacement, that is, the orifice is assumed to be closed at the initial position of the control member (zero displacement), and the maximum opening takes place at the maximum displacement.

The *valve maximum area* is 1.5x the maximum area of the orifice. This is the **Orifice maximum area** if the parameterization is **By maximum area and opening**, or the final element of the **Tabulated orifice area** if the parameterization is **By area vs. opening table**.

In the second case, the passage area is determined by one-dimensional interpolation from the table $A=A(h)$. In both cases, a small leakage area is assumed to exist even after the orifice is completely closed. Physically, it represents a possible clearance in the closed valve, but the main purpose of the parameter is to maintain numerical integrity of the circuit by preventing a portion of the system from getting isolated after the valve is completely closed. An isolated or “hanging” part of the system could affect computational efficiency and even cause failure of computation.

The block positive direction is from port **A** to port **B**. This means that the flow rate is positive if it flows from **A** to **B**, and the pressure differential is determined as $\Delta p = p_A - p_B$. A positive signal at port **C** opens the valve.

Assumptions and Limitations

Fluid inertia is not taken into account.

Parameters

Model parameterization

Select one of the following methods for specifying the orifice:

- By **maximum area and opening** — Provide values for the maximum orifice area and the maximum orifice opening. The passage area is linearly dependent on the control member displacement, that is, the orifice is closed at the initial position of the control member (zero displacement), and the maximum opening takes place at the maximum displacement. This is the default method.
- By **area vs. opening table** — Provide tabulated data of orifice openings and corresponding orifice areas. The passage area is determined by one-dimensional table lookup. You have a choice of two interpolation methods and two extrapolation methods.

Orifice maximum area

Specify the area of a fully opened orifice. The parameter value must be greater than zero. The *valve maximum area* is 1.5x the **Orifice maximum area**. The default value is $5e-5 \text{ m}^2$. This parameter is used if **Model parameterization** is set to **By maximum area and opening**.

Orifice maximum opening

Specify the maximum displacement of the control member. The parameter value must be greater than zero. The default value is $5e-4 \text{ m}$. This parameter is used if **Model parameterization** is set to **By maximum area and opening**.

Tabulated orifice openings

Specify the vector of input values for orifice openings as a one-dimensional array. The input values vector must be strictly increasing. The values can be nonuniformly spaced. The minimum number of values depends on the interpolation method: you must provide at least two values for linear interpolation, at least three values for smooth interpolation. The default values, in meters, are $[-2e-3, 0, 5e-3, 15e-3]$. This parameter is used if **Model parameterization** is set to **By area vs. opening table**. **Tabulated orifice openings** values will be used together with **Tabulated orifice area** values for one-dimensional table lookup.

Tabulated orifice area

Specify the vector of orifice areas as a one-dimensional array. The vector must be of the same size as the orifice openings vector. All the values must be positive. The *valve maximum area* is 1.5x the last element of the **Tabulated orifice area**. The default values, in m^2 , are

[1e-12, 4e-12, 1.e-5, 1.02e-5]. This parameter is used if **Model parameterization** is set to By area vs. opening table.

Interpolation method

This parameter is used if **Model parameterization** is set to By area vs. opening table. Select one of the following interpolation methods for approximating the output value when the input value is between two consecutive grid points:

- **Linear** — Select this option to get the best performance.
- **Smooth** — Select this option to produce a continuous curve with continuous first-order derivatives.

For more information on interpolation algorithms, see the PS Lookup Table (1D) block reference page.

Extrapolation method

This parameter is used if **Model parameterization** is set to By area vs. opening table. Select one of the following extrapolation methods for determining the output value when the input value is outside the range specified in the argument list:

- **Linear** — Select this option to produce a curve with continuous first-order derivatives in the extrapolation region and at the boundary with the interpolation region.
- **Nearest** — Select this option to produce an extrapolation that does not go above the highest point in the data or below the lowest point in the data.

For more information on extrapolation algorithms, see the PS Lookup Table (1D) block reference page.

Pressure differential across the orifice

Pressure difference that must be maintained across the element by the pressure compensator. The default value is 6e5 Pa.

Pressure reducing valve regulation range

Pressure increase over the preset level needed to fully close the valve. Must be less than 0.2 of the **Pressure differential across the orifice** parameter value. The default value is 5e4 Pa.

Flow discharge coefficient

Semi-empirical parameter for orifice capacity characterization. Its value depends on the geometrical properties of the orifice, and usually is provided in textbooks or manufacturer data sheets. The default value is 0.7.

Initial opening

Orifice initial opening. The parameter can be positive (underlapped orifice), negative (overlapped orifice), or equal to zero for zero lap configuration. The value of initial opening does not depend on the orifice orientation. The default value is 0.

Laminar transition specification

Select how the block transitions between the laminar and turbulent regimes:

- **Pressure ratio** — The transition from laminar to turbulent regime is smooth and depends on the value of the **Laminar flow pressure ratio** parameter. This method provides better simulation robustness.
- **Reynolds number** — The transition from laminar to turbulent regime is assumed to take place when the Reynolds number reaches the value specified by the **Critical Reynolds number** parameter.

Laminar flow pressure ratio

Pressure ratio at which the flow transitions between laminar and turbulent regimes. The default value is 0.999. This parameter is visible only if the **Laminar transition specification** parameter is set to Pressure ratio.

Critical Reynolds number

The maximum Reynolds number for laminar flow. The value of the parameter depends on the orifice geometrical profile. You can find recommendations on the parameter value in hydraulics textbooks. The default value is 12. This parameter is visible only if the **Laminar transition specification** parameter is set to Reynolds number.

Leakage area

The total area of possible leaks in the completely closed valve. The main purpose of the parameter is to maintain numerical integrity of the circuit by preventing a portion of the system from getting isolated after the valve is completely closed. The parameter value must be greater than 0. The default value is $1e-12 \text{ m}^2$.

Restricted Parameters

When your model is in Restricted editing mode, you cannot modify the following parameters:

- **Model parameterization**
- **Interpolation method**
- **Extrapolation method**
- **Laminar transition specification**

All other block parameters are available for modification. The actual set of modifiable block parameters depends on the value of the **Model parameterization** parameter at the time the model entered Restricted mode.

Global Parameters

Parameters determined by the type of working fluid:

- **Fluid density**
- **Fluid kinematic viscosity**

Use the Hydraulic Fluid block or the Custom Hydraulic Fluid block to specify the fluid properties.

Ports

The block has the following ports:

A

Hydraulic conserving port associated with the valve inlet.

B

Hydraulic conserving port associated with the valve outlet.

C

Physical signal control port.

Extended Capabilities

C/C++ Code Generation

Generate C and C++ code using Simulink® Coder™.

See Also

Ball Valve | Gate Valve | Needle Valve | Poppet Valve

Topics

“Upgrading Simscape Fluids Models Containing Hydraulics (Isothermal) Blocks”

Introduced in R2006a

Pressure-Compensated Flow Control Valve (IL)

Flow control with pressure regulation in an isothermal liquid system

Library: Simscape / Fluids / Isothermal Liquid / Valves & Orifices / Flow Control Valves



Description

The Pressure-Compensated Flow Control Valve (IL) block provides constant-pressure flow control through an Orifice (IL) block via a Pressure Compensator Valve (IL) connected in series. When the control pressure over the orifice, $p_A - p_B$, meets or exceeds the **Set orifice pressure differential**, the reducing valve in the pressure compensator component begins to close, which maintains the pressure in the orifice. For systems with venting or redirection of fluid to another part of the system, see the Pressure-Compensated 3-Way Flow Control Valve (IL) block.

The valve opening and closing is controlled by a physical signal received at port **S**. A positive signal opens the valve.

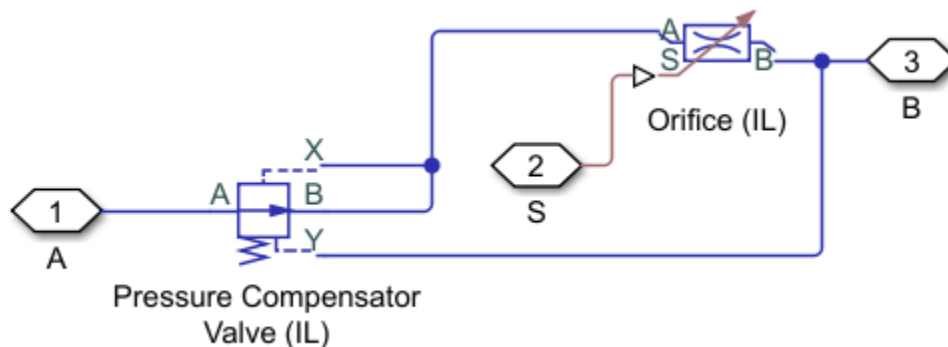

Flow Control Valve Schematic

Numerically-Smoothed Area and Pressure

At the extremes of the orifice area and valve pressure range, you can maintain numerical robustness in your simulation by adjusting the block **Smoothing factor**. A smoothing function is applied to all calculated areas and pressures, but primarily influences the simulation at the extremes of these ranges.

The normalized orifice area is calculated as:

$$\hat{A} = \frac{(A - A_{leak})}{(A_{max} - A_{leak})}$$

where:

- A_{leak} is the **Leakage area**.
- A_{max} is the cushion **Maximum orifice area**.

The **Smoothing factor**, f , is applied to the normalized area:

$$\widehat{A}_{smoothed} = \frac{1}{2} + \frac{1}{2}\sqrt{\widehat{A}^2 + \left(\frac{f}{4}\right)^2} - \frac{1}{2}\sqrt{(\widehat{A} - 1)^2 + \left(\frac{f}{4}\right)^2}.$$

The smoothed orifice area is:

$$A_{smoothed} = \widehat{A}_{smoothed}(A_{max} - A_{leak}) + A_{leak}.$$

Similarly, the normalized valve pressure is:

$$\widehat{p} = \frac{(p - p_{set})}{(p_{max} - p_{set})}.$$

where:

- p_{set} is the **Set orifice pressure differential**.
- p_{max} is the sum of the **Set orifice pressure differential** and the **Pressure compensator valve regulation range**.

Smoothing applied to the normalized pressure is:

$$\widehat{p}_{smoothed} = \frac{1}{2} + \frac{1}{2}\sqrt{\widehat{p}^2 + \left(\frac{f}{4}\right)^2} - \frac{1}{2}\sqrt{(\widehat{p} - 1)^2 + \left(\frac{f}{4}\right)^2},$$

and the smoothed pressure is:

$$p_{smoothed} = \widehat{p}_{smoothed}(p_{max} - p_{set}) + p_{set}.$$

Orifice Parameterization

Setting **Orifice parameterization** to:

- **Linear** - area vs. control member position assumes that the spool position and the orifice opening area are related linearly.
- **Tabulated data** - Area vs. control member position interpolates user-provided data between the orifice opening area and the control member position with a potentially nonlinear relationship.
- **Tabulated data** - Volumetric flow rate vs. control member position and pressure drop interpolates the orifice volumetric flow rate directly from user-provided data between the control member position, orifice pressure drop, and orifice volumetric flow rate.

Ports

Conserving

A – Liquid port

isothermal liquid

Liquid entry or exit point to the valve.

B – Liquid port

isothermal liquid

Liquid entry or exit point to the valve.

Input**S – Physical signal, in m**

physical signal

Orifice opening in m, returned as a physical signal. A positive signal opens the orifice.

Parameters**Orifice parameterization – Method of modeling orifice opening**

Linear - area vs. control member position (default) | Tabulated data - Area vs. control member position | Tabulated data - Volumetric flow rate vs. control member position and pressure drop

Method of modeling the opening of the orifice. The opening is either parametrized linearly, which correlates the opening area to the control member position; by user-supplied data that correlate the orifice opening area to the control member position; or by an array of data that correlates the valve flow rate to the control member position and valve pressure drop.

Control member travel between closed and open valve – Maximum control member stroke

5e-3 m (default) | positive scalar

Control member stroke that fully opens the orifice.

DependenciesTo enable this parameter, set **Orifice parameterization** to Linear - area vs. control member travel.**Maximum orifice area – Maximum orifice cross-sectional area**8e-5 m² (default) | positive scalar

Cross-sectional area of the orifice in its fully open position. This parameter is used as an upper limit for area-pressure calculations during the simulation.

DependenciesTo enable this parameter, set **Orifice parameterization** to Linear - area vs. control member travel.**Control member position at closed valve – Control member offset**

0 m (default) | positive scalar

Control member offset when the orifice is fully open. A positive, nonzero value indicates a partially closed orifice. A negative, nonzero value indicates an overlapped orifice that remains open for an initial displacement set by the physical signal at port S.

Dependencies

To enable this parameter, set **Orifice parameterization** to Linear - area vs. control member travel.

Control member position vector – Vector of control member travel distances

[0, .002, .007] (default) | 1-by-*n* vector

Vector of orifice opening distances for the tabular parameterization of the orifice opening area. The vector elements must correspond one-to-one with the elements in the **Orifice area vector** parameter. The elements are listed in ascending order and the first element must be 0. Linear interpolation is employed between table data points.

Dependencies

To enable this parameter, set **Orifice parameterization** to Tabulated data - Area vs. control member position.

Orifice area vector – Vector of opening areas

[1e-09, 4e-09, 1e-05] m² (default) | 1-by-*n* vector

Vector of valve opening areas for the tabular parameterization of the valve opening area. The vector elements must correspond one-to-one with the elements in the **Control member position vector** parameter. The elements are listed in ascending order and must be greater than 0.

Dependencies

To enable this parameter, set **Orifice parameterization** to Tabulated data - Area vs. control member position.

Control member position vector, *s* – Vector of control member displacements

[0, .002, .004, .007, .017] m (default) | 1-by-*n* vector

Vector of control member positions for the tabular parameterization of the volumetric flow rate. The control member position vector forms an independent axis with the **Pressure drop vector, *dp*** parameter for the 3-D dependent **Volumetric flow rate table, *q(s,dp)*** parameter. A positive displacement corresponds to valve opening. The values are listed in ascending order and the first element must be 0. Linear interpolation is employed between table data points.

Dependencies

To enable this parameter, set **Orifice parameterization** to Volumetric flow rate vs. control member position and pressure drop.

Pressure drop vector, *dp* – Vector of pressure differential values

[.3, .5, .7] MPa (default) | 1-by-*n* vector

Vector of valve opening areas for the tabular parameterization of the valve opening area. The pressure drop vector forms an independent axis with the **Control member position vector, *s*** parameter for the 3-D dependent **Volumetric flow rate table, *q(s,dp)*** parameter. The values are listed in ascending order and must be greater than 0. Linear interpolation is employed between table data points.

Dependencies

To enable this parameter, set **Orifice parameterization** to Volumetric flow rate vs. control member position and pressure drop.

Volumetric flow rate table, $q(s, dp)$ – Array of volumetric flow rate values

[1.7e-05, 2e-05, 2.6e-05; .0035, .0045, .0053; .7, .9, 1.06; 1.96, 2.5, 3; 6, 7.7, 9.13] .* 1e-3 m³/s (default) | M -by- N array

Array of volumetric flow rates based on independent values of pressure drop and spool travel distance. M and N are the sizes of the corresponding vectors:

- M is the number of elements in the **Pressure drop vector, dp** parameter.
- N is the number of elements in the **Control member position vector, s** parameter.

Dependencies

To enable this parameter, set **Orifice parameterization** to Volumetric flow rate vs. control member position and pressure drop.

Set orifice pressure differential – Threshold for compensator valve operation

0.6 MPa (default) | scalar

Magnitude of pressure differential that triggers valve opening or closing.

Pressure compensator valve regulation range – Pressure operational region of the pressure compensating valve

0.1 MPa (default) | scalar

Operational pressure range of the valve. The pressure regulation range lies between the **Set orifice pressure differential** and the maximum valve operating pressure.

Pressure compensator valve maximum area – Area of the fully opened pressure compensator valve

1.5 * 8e-5 m² (default) | positive scalar

Cross-sectional area of the valve in its fully open position. This parameter is used as an upper limit for area-pressure calculations during the simulation.

Leakage area – Gap area when in fully closed position

1e-10 m² (default) | positive scalar

Sum of all gaps when the valve is in the fully closed position. Any area smaller than this value is maintained at the specified leakage area. This contributes to numerical stability by maintaining continuity in the flow.

Discharge coefficient – Discharge coefficient

0.64 (default) | positive scalar

Correction factor that accounts for discharge losses in theoretical flows.

Critical Reynolds number – Upper Reynolds number limit for laminar flow

150 (default) | positive scalar

Upper Reynolds number limit for laminar flow through the valve.

Smoothing factor – Numerical smoothing factor

0.01 (default) | positive scalar in the range [0,1]

Continuous smoothing factor that introduces a layer of gradual change to the flow response when the valve is in near-open or near-closed positions. Set this value to a nonzero value less than one to increase the stability of your simulation in these regimes.

See Also

Pressure-Compensated 3-Way Flow Control Valve (IL) | Pressure Compensator Valve (IL) | Pressure-Reducing 3-Way Valve (IL) | Shuttle Valve (IL) | Orifice (IL)

Introduced in R2020a

Pressure Compensator

Valve used to regulate the pressure drop across a hydraulic component

Library: Simscape / Fluids / Hydraulics (Isothermal) / Valves / Pressure Control Valves



Description

The Pressure Compensator block models the flow through a valve that constricts so as to maintain a preset pressure drop between a chosen two hydraulic nodes. The valve has four hydraulic ports, two being flow passages (the inlet, **A**, and the outlet, **B**) and two pressure sensors (**X** and **Y**). The normally open valve contracts when the pressure drop from **X** to **Y** rises above the valve pressure setting. The drop in opening area is a function of the pressure drop—proportional to it in a linear parameterization (the block default) or a general function of it in a tabulated parameterization. The valve serves its purpose until it hits the limit of its pressure regulation range—a point at which the valve is fully closed and the pressure drop can again rise unabated.

Valve Opening

The opening area calculation depends on the valve parameterization selected for the block: either Linear area-opening relationship or Tabulated data - Area vs. pressure.

Linear Parameterization

If the **Valve parameterization** block parameter is in the default setting of Linear area-opening relationship, the opening area is computed as:

$$S(\Delta p_{xy}) = S_{\text{Max}} - k(\Delta p_{xy} - \Delta p_{\text{Set}}),$$

where:

- S_{Max} is the value specified in the **Maximum passage area** block parameter.
- Δp_{Set} is the value specified in the **Valve pressure setting** block parameter.
- Δp_{XY} is the pressure drop from port **X** to port **Y**:

$$\Delta p_{XY} = p_X - p_Y,$$

where p is the gauge pressure at the port indicated by the subscript (**X** or **Y**).

- k is the linear constant of proportionality:

$$k = \frac{S_{\text{Max}} - S_{\text{Leak}}}{\Delta p_{\text{Reg}}},$$

where in turn:

- S_{Leak} is the value specified in the **Leakage area** block parameter.

- Δp_{Reg} is that specified in the **Valve regulation range** block parameter.

At and below the valve pressure setting, the opening area is that of a fully open valve:

$$S(\Delta p_{XY} \leq \Delta p_{\text{Set}}) = S_{\text{Max}}.$$

At and above a maximum pressure, the opening area is that due to internal leakage alone:

$$S(\Delta p \geq \Delta p_{\text{Max}}) = S_{\text{Leak}},$$

where the maximum pressure drop Δp_{Max} is the sum:

$$\Delta p_{\text{Max}} = \Delta p_{\text{Set}} + \Delta p_{\text{Reg}}.$$

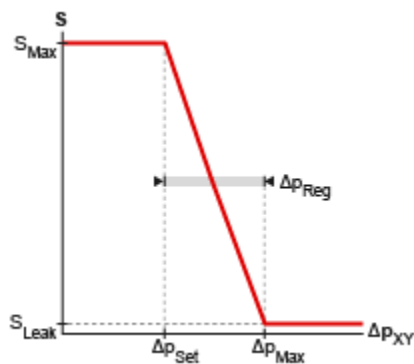

Opening area in the Linear area-opening relationship parameterization

Tabulated Parameterization

If the **Valve parameterization** block parameter is set to Tabulated data - Area vs. pressure, the opening area is computed as:

$$S = S(\Delta p_{XY}),$$

where S_{XY} is a tabulated function constructed from the **Pressure drop vector** and **Opening area vector** block parameters. The function is based on linear interpolation (for points within the data range) and nearest-neighbor extrapolation (for points outside the data range). The leakage and maximum opening areas are the minimum and maximum values of the **Valve opening area vector** block parameter.

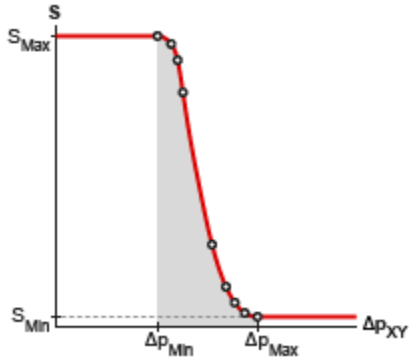

Opening area in the Tabulated data - Area vs. pressure parameterization

Opening Dynamics

By default, the valve opening dynamics are ignored. The valve is assumed to respond instantaneously to changes in the pressure drop, without time lag between the onset of a pressure disturbance and the increased valve opening that the disturbance produces. If such time lags are of consequence in a model, you can capture them by setting the **Opening dynamics** block parameter to `Include valve opening dynamics`. The valves then open each at a rate given by the expression:

$$\dot{S} = \frac{S(\Delta p_{SS}) - S(\Delta p_{In})}{\tau},$$

where τ is a measure of the time needed for the instantaneous opening area (subscript In) to reach a new steady-state value (subscript SS).

Leakage Area

The primary purpose of the leakage area of a closed valve is to ensure that at no time does a portion of the hydraulic network become isolated from the remainder of the model. Such isolated portions reduce the numerical robustness of the model and can slow down simulation or cause it to fail. Leakage is generally present in minuscule amounts in real valves but in a model its exact value is less important than it being a small number greater than zero. The leakage area is obtained from the block parameter of the same name.

Valve Flow Rate

The causes of the pressure losses incurred in the passages of the valve are ignored in the block. Whatever their natures—sudden area changes, flow passage contortions—only their cumulative effect is considered during simulation. This effect is captured in the block by the discharge coefficient, a measure of the flow rate through the valve relative to the theoretical value that it would have in an ideal valve. The flow rate through the valve is defined as:

$$q = C_D S \sqrt{\frac{2}{\rho} \frac{\Delta p_{AB}}{[(\Delta p_{AB})^2 + p_{Crit}^2]^{1/4}}},$$

where:

- q is the volumetric flow rate through the valve.
- C_D is the value of the **Discharge coefficient** block parameter.

- S is the opening area of the valve.
- Δp_{AB} is the pressure drop from port **A** to port **B**.
- p_{Crit} is the pressure differential at which the flow shifts between the laminar and turbulent flow regimes.

The calculation of the critical pressure depends on the setting of the **Laminar transition specification** block parameter. If this parameter is in the default setting of By pressure ratio:

$$p_{\text{Crit}} = (p_{\text{Atm}} + p_{\text{Avg}})(1 - \beta_{\text{Crit}}),$$

where:

- p_{Atm} is the atmospheric pressure (as defined for the corresponding hydraulic network).
- p_{Avg} is the average of the gauge pressures at ports **A** and **B**.
- β_{Crit} is the value of the **Laminar flow pressure ratio** block parameter.

If the **Laminar transition specification** block parameter is instead set to By Reynolds number:

$$p_{\text{Crit}} = \frac{\rho}{2} \left(\frac{Re_{\text{Crit}} \nu}{C_D D_H} \right)^2,$$

where:

- Re_{Crit} is the value of the **Critical Reynolds number** block parameter.
- ν is the kinematic viscosity specified for the hydraulic network.
- D_H is the instantaneous hydraulic diameter:

$$D_H = \sqrt{\frac{4S}{\pi}}.$$

Ports

Conserving

A – Valve inlet

hydraulic (isothermal liquid)

Opening through which the flow can enter the valve.

B – Valve outlet

hydraulic (isothermal liquid)

Opening through which the flow can exit the valve.

X – Pressure sensor

hydraulic (isothermal liquid)

Port at which pressure is measured for the purpose of setting the valve opening area.

Y – Pressure sensor

hydraulic (isothermal liquid)

Port at which pressure is measured for the purpose of setting the valve opening area.

Parameters

Opening area parameterization — Method by which to calculate the opening area of the valve

Linear area-opening relationship (default) | Tabulated data - Area vs. pressure

Method by which to calculate the opening area of the valve. The default setting prescribes a linear relationship between the opening area of the valve and the pressure drop between its sensor ports. The alternative setting allows for a general, nonlinear relationship to be specified in tabulated form.

Maximum passage area — Opening area of the valve in the fully open position

$1e-4 \text{ m}^2$ (default) | positive scalar in units of area

Opening area of the valve in the fully open position. The valve is fully open if the pressure drop from port **X** to port **Y** is less than the value specified in the **Valve pressure setting** block parameter.

Dependencies

This parameter is active when the **Opening area parameterization** block parameter is set to Linear area-pressure relationship.

Valve pressure setting — Pressure drop to maintain from port X to port Y

$30e5 \text{ Pa}$ (default) | positive scalar in units of pressure

Pressure drop from port **X** to port **Y** that the valve is to maintain. The valve closes in proportion to the pressure drop if it should exceed the value specified here. If the pressure drop is less than this value, the opening area is that specified in the **Maximum passage area** block parameter.

Dependencies

This parameter is active when the **Opening area parameterization** block parameter is set to Linear area-pressure relationship.

Valve regulation range — Pressure drop interval over which the valve is to designed to operate

$1.5e5 \text{ Pa}$ (default) | positive scalar in units of pressure

Pressure drop interval over which the valve is designed to operate. This interval stretches from the largest pressure drop at which the valve is fully open to the lowest pressure drop at which the valve is fully closed. Only within this range is the valve capable of maintaining the specified pressure setting.

Dependencies

This parameter is active when the **Opening area parameterization** block parameter is set to Linear area-pressure relationship.

Discharge coefficient — Empirical factor defined as the ratio of actual to ideal mass flow rates

0.7 (default) | positive unitless scalar

Ratio of the actual flow rate through the valve to the theoretical value that it would have in an ideal valve. This semi-empirical parameter measures the flow allowed through the valve: the greater its value, the greater the flow rate. Refer to the valve data sheet, if available, for this parameter.

Leakage area — Opening area of the valve in the maximally closed position

$1e-10 \text{ m}^2$ (default) | positive scalar in units of area

Opening area of the valve in the fully closed position, when only internal leakage between its ports remains. This parameter serves primarily to ensure that closure of the valve does not cause portions of the thermal liquid network to become isolated. The exact value specified here is less important than its being a small number greater than zero.

Dependencies

This parameter is active when the **Opening area parameterization** block parameter is set to Linear area-pressure relationship.

Pressure differential vector — Vector of pressure drops at which to tabulate the valve opening areas

[30.15E5 : 15E3 : 31.35E5] Pa (default) | vector of positive numbers in units of pressure

Vector of pressure differentials from port **X** to port **Y** at which to specify the opening area of the valve. The vector elements must increase monotonically from left to right. This order is important when specifying the **Opening area vector** block parameter.

The block uses this data to construct a lookup table by which to determine from the pressure differential the valve opening area. Data is handled with linear interpolation (within the tabulated data range) and nearest-neighbor extrapolation (outside of the range).

Dependencies

This parameter is active when the **Opening area parameterization** block parameter is set to Tabulated data - Area vs. pressure.

Opening area vector — Vector of opening areas at the specified pressure differential breakpoints

[9E-5 : -1 : 1E-5] m^2 (default) | vector of positive numbers in units of area

Vector of opening areas corresponding to the breakpoints defined in the **Pressure differential vector** block parameter. The vector elements must decrease monotonically from left to right (with increasing pressure). For best results, avoid regions of flattened slope.

The block uses this data to construct a lookup table by which to determine from the pressure differential the valve opening area. Data is handled with linear interpolation (within the tabulated data range) and nearest-neighbor extrapolation (outside of the range).

Dependencies

This parameter is active when the **Opening area parameterization** block parameter is set to Tabulated data - Area vs. pressure.

Laminar transition specification — Parameter in terms of which to define the boundary between laminar and turbulent regimes

Pressure ratio (default) | Reynolds number

Parameter in terms of which to specify the boundary between the laminar and turbulent flow regimes. The pressure ratio of the default parameterization is defined as the gauge pressure at the outlet divided by the same at the inlet.

Laminar flow pressure ratio — Pressure ratio at which the flow transitions between laminar and turbulent regimes

0.999 (default) | positive unitless scalar

Pressure ratio at which the flow is assumed to transition between laminar and turbulent regimes. The pressure ratio is defined as the gauge pressure at the outlet divided by the same at the inlet. The transition is assumed to be smooth and centered on this value.

Dependencies

This parameter is active when the **Laminar transition specification** block parameter is set to Pressure ratio.

Critical Reynolds number — Reynolds number at the boundary between laminar and turbulent flow regimes

12 (default) | positive unitless scalar

Reynolds number at which the flow is assumed to transition between laminar and turbulent regimes.

Dependencies

This parameter is active when the **Laminar transition specification** block parameter is set to Reynolds number.

Opening dynamics — Choice of whether to capture the opening dynamics of the valve

Do not include valve opening dynamics (default) | Include valve opening dynamics

Choice of whether to capture the opening dynamics of the valve. Selecting Include valve opening dynamics causes the valve to open gradually, so as to approach its new steady-state area over a small time span. The characteristic time for such transitions is given in the **Opening time constant** block parameter.

Setting this parameter to the alternative Do not include valve opening dynamics is equivalent to specifying a value of 0 for the opening time constant. The opening area is in this case assumed to reach its new steady-state value instantaneously.

Include opening dynamics to more accurately capture the behavior of a real valve. For best real-time simulation performance, use with a local solver or disable valve opening dynamics altogether.

Opening time constant — Characteristic time scale of the valve opening transitions

0.1 s (default) | positive scalar in units of time

Measure of the time taken by the valve to transition from its current opening area to a new steady-state value. The block uses this parameter to calculate the rate at which a valve is opening and from it the instantaneous opening area at the next time step.

Dependencies

This parameter is active when the **Opening dynamics** block parameter is set to Include valve opening dynamics.

Initial area — Opening area at the start of simulation1e-12 m² (default) | positive scalar in units of area

Area normal to the direction of flow within the valve at the start of simulation. The block uses this parameter to calculate the initial rate at which the valve is opening and from it the instantaneous opening area at the next time step.

Dependencies

This parameter is active when the **Opening dynamics** block parameter is set to Include valve opening dynamics.

Extended Capabilities**C/C++ Code Generation**

Generate C and C++ code using Simulink® Coder™.

See Also

Pressure Reducing 3-Way Valve | Pressure Reducing Valve | Pressure Relief Valve

Topics

“Upgrading Simscape Fluids Models Containing Hydraulics (Isothermal) Blocks”

Introduced in R2016a

Pressure Compensator Valve (IL)

Pressure-maintaining valve for external component in an isothermal system

Library: Simscape / Fluids / Isothermal Liquid / Valves & Orifices / Pressure Control Valves



Description

The Pressure Compensator Valve (IL) block represents an isothermal liquid pressure compensator, such as a pressure relief valve or pressure-reducing valve. Use this valve when you would like to maintain the pressure at the valve based on signals from another part of the system.

When the pressure differential between ports **X** and **Y** (the control pressure) meets or exceeds the set pressure, the valve area opens (for normally closed valves) or closes (for normally open valves) in order to maintain the pressure in the valve. The pressure regulation range begins at the set pressure. P_{set} is constant in the case of a **Constant** valve, or varying in the case of a **Controlled** valve. A physical sign at port **Ps** provides a varying set pressure.

Pressure Control

Pressure regulation occurs when the sensed pressure, $P_x - P_y$, or P_{control} , exceeds a specified pressure, P_{set} . The Pressure Compensator Valve (IL) block supports two modes of regulation:

- When **Set pressure control** is set to **Controlled**, connect a pressure signal to port **Ps** and set the constant **Pressure regulation range**. pressure regulation is triggered when P_{control} is greater than P_{set} , the **Set pressure differential**, and below P_{max} , the sum of the set pressure and the user-defined **Pressure regulation range**.
- When **Set pressure control** is set to **Constant**, the valve opening is continuously regulated between P_{set} and P_{max} by either a linear or tabular parametrization. When **Opening parametrization** is set to **Tabular data**, P_{set} and P_{max} are the first and last parameters of the **Pressure differential vector**, respectively.

Mass Flow Rate Equation

Momentum is conserved through the valve:

$$\dot{m}_A + \dot{m}_B = 0.$$

The mass flow rate through the valve is calculated as:

$$\dot{m} = \frac{C_d A_{\text{valve}} \sqrt{2\bar{\rho}}}{\sqrt{PR_{\text{loss}} \left(1 - \left(\frac{A_{\text{valve}}}{A_{\text{port}}} \right)^2 \right)}} \frac{\Delta p}{[\Delta p^2 + \Delta p_{\text{crit}}^2]^{1/4}},$$

where:

- C_d is the **Discharge coefficient**.
- A_{valve} is the instantaneous valve open area.
- A_{port} is the **Cross-sectional area at ports A and B**.
- $\bar{\rho}$ is the average fluid density.
- Δp is the valve pressure difference $p_A - p_B$.

The critical pressure difference, Δp_{crit} , is the pressure differential associated with the **Critical Reynolds number**, Re_{crit} , the flow regime transition point between laminar and turbulent flow:

$$\Delta p_{crit} = \frac{\pi \bar{\rho}}{8 A_{valve}} \left(\frac{\nu Re_{crit}}{C_d} \right)^2.$$

Pressure loss describes the reduction of pressure in the valve due to a decrease in area. PR_{loss} is calculated as:

$$PR_{loss} = \frac{\sqrt{1 - \left(\frac{A_{valve}}{A_{port}}\right)^2 (1 - C_d^2)} - C_d \frac{A_{valve}}{A_{port}}}{\sqrt{1 - \left(\frac{A_{valve}}{A_{port}}\right)^2 (1 - C_d^2)} + C_d \frac{A_{valve}}{A_{port}}}.$$

Pressure recovery describes the positive pressure change in the valve due to an increase in area. If **Pressure recovery** is set to **Off**, PR_{loss} is 1.

The opening area, A_{valve} , is determined by the opening parametrization (for **Constant** valves only) and the valve opening dynamics.

Valve Opening Parametrization

The linear parametrization of the valve area for **Normally open** valves is:

$$A_{valve} = \hat{p}(A_{leak} - A_{max}) + A_{max},$$

and for **Normally closed** valves is:

$$A_{valve} = \hat{p}(A_{max} - A_{leak}) + A_{leak}.$$

For tabular parametrization of the valve area in its operating range, A_{leak} and A_{max} are the first and last parameters of the **Opening area vector**, respectively.

The normalized pressure, \hat{p} , is:

$$\hat{p} = \frac{p_{control} - p_{set}}{p_{max} - p_{set}}.$$

At the extremes of the valve pressure range, you can maintain numerical robustness in your simulation by adjusting the block **Smoothing factor**. With a nonzero smoothing factor, a smoothing function is applied to all calculated valve pressures, but primarily influences the simulation at the extremes of these ranges.

When the **Smoothing factor**, f , is nonzero, a smoothed, normalized pressure is instead applied to the valve area:

$$\hat{p}_{smoothed} = \frac{1}{2} + \frac{1}{2}\sqrt{\hat{p}^2 + \left(\frac{f}{4}\right)^2} - \frac{1}{2}\sqrt{(\hat{p} - 1)^2 + \left(\frac{f}{4}\right)^2}.$$

In the **Tabulated data** parameterization, the smoothed, normalized pressure is also used when the smoothing factor is nonzero with linear interpolation and nearest extrapolation.

Opening Dynamics

If opening dynamics are modeled, a lag is introduced to the flow response to the modeled control pressure. $p_{control}$ becomes the dynamic control pressure, p_{dyn} ; otherwise, $p_{control}$ is the steady-state pressure. The instantaneous change in dynamic control pressure is calculated based on the **Opening time constant**, τ :

$$\dot{p}_{dyn} = \frac{p_{control} - p_{dyn}}{\tau}.$$

By default, **Opening dynamics** is set to **Off**. A nonzero **Smoothing factor** can provide additional numerical stability when the orifice is in near-closed or near-open position.

Steady-state dynamics are set by the same parametrization as the valve opening, and are based on the control pressure, $p_{control}$.

Faulty Behavior

When faults are enabled, the valve open area becomes stuck at a specified value in response to one of these triggers:

- Simulation time — Faulting occurs at a specified time.
- Simulation behavior — Faulting occurs in response to an external trigger. This exposes port **Tr**.

Three fault options are available in the **Opening area when faulted** parameter:

- **Closed** — The valve freezes at its smallest value, depending on the **Opening parameterization**:
 - When **Opening parameterization** is set to **Linear**, the valve area freezes at the **Leakage area**.
 - When **Opening parameterization** is set to **Tabulated data**, the valve area freezes at the first element of the **Opening area vector**.
- **Open** — The valve freezes at its largest value, depending on the **Opening parameterization**:
 - When **Opening parameterization** is set to **Linear**, the valve area freezes at the **Maximum opening area**.
 - When **Orifice parameterization** is set to **Tabulated data**, the valve area freezes at the last element of the **Opening area vector**.
- **Maintain last value** — The valve area freezes at the valve open area when the trigger occurred.

Due to numerical smoothing at the extremes of the valve area, the minimum area applied is larger than the **Leakage area**, and the maximum is smaller than the **Maximum orifice area**, in proportion to the **Smoothing factor** value.

Once triggered, the valve remains at the faulted area for the rest of the simulation.

Ports

Conserving

A – Liquid port

isothermal liquid

Entry or exit port of the liquid to or from the valve.

B – Liquid port

isothermal liquid

Entry or exit port of the liquid to or from the valve.

X – Pressure reference, MPa

isothermal liquid

Absolute pressure in units of MPa, denoted P_x .

Y – Pressure reference, MPa

isothermal liquid

Absolute pressure in units of MPa, denoted P_y .

Input

Ps – Controlled pressure differential

physical signal

Pressure differential for controlled valve operation, specified as a physical signal.

Dependencies

To enable this parameter, set **Set pressure control** to **Controlled**.

Tr – External fault trigger

physical signal

Physical signal port for an external fault trigger. Triggering occurs when the value is greater than 0.5. There is no unit associated with the trigger value.

Dependencies

This port is visible when **Enable faults** is set to **On** and **Fault trigger** is set to **External**.

Parameters

Parameters

Valve specification – Valve bias

Normally open (default) | Normally closed

Normal operating condition of the pressure compensator valve. A reducing valve is a **Normally open** valve and a relief valve is a **Normally closed** valve.

Set pressure control – Constant or controlled valve operation

Constant (default) | Controlled

Valve operation method. The valve can operate according to a specified pressure regulation range or **Opening parametrization**.

Opening parameterization – Method of modeling constant valve opening or closing

Linear (default) | Tabulated data

Method of modeling the valve opening or closing. The valve opening is either parametrized linearly or by a table of values correlating the area to pressure differential.

Dependencies

To enable this parameter, set **Set pressure control** to Constant.

Set pressure differential – Range outside of which constant valve operation is triggered

0 MPa (default) | scalar

Magnitude of pressure differential that triggers operation of a constant valve when pressure exceeds (Normally closed) or falls below (Normally open).

Dependencies

To enable this parameter, set **Set pressure control** to Constant and **Opening parametrization** to Linear.

Pressure regulation range – Valve operational pressure range

0.1 MPa (default) | scalar

Operational pressure range of the valve. The pressure regulation range lies between the **Set pressure differential** and the maximum valve operating pressure.

Dependencies

To enable this parameter, set either:

- **Set pressure control** to Controlled
- **Set pressure control** to Constant and **Opening parametrization** to Linear

Maximum opening area – Area of fully-opened valve1e-4 m² (default) | positive scalar

Cross-sectional area of the valve in its fully open position.

Dependencies

To enable this parameter, set either:

- **Set pressure control** to Controlled
- **Set pressure control** to Constant and **Opening parametrization** to Linear

Leakage area – Gap area when in fully closed position1e-10 m² (default) | positive scalar

Sum of all gaps when the valve is in fully closed position. Any area smaller than this value is saturated to the specified leakage area. This contributes to numerical stability by maintaining continuity in the flow.

Dependencies

To enable this parameter, set either:

- **Set pressure control** to Controlled
- **Set pressure control** to Constant and **Opening parametrization** to Linear

Pressure differential vector — Vector of differential pressure values for tabular parametrization

[0.2 : 0.2 : 1.2] MPa (default) | 1-by-n vector

Vector of pressure differential values for the tabular parameterization of opening area. The vector elements must correspond one-to-one to the values in the **Opening area vector** parameter. The pressures must be greater than 0 and are listed in ascending order.

Dependencies

To enable this parameter, set **Set pressure control** to Constant and **Opening parametrization** to Tabulated data.

Opening area vector — Vector of valve opening areas for tabular parametrization

[1e-05, 8e-06, 6e-06, 4e-06, 2e-06, 1e-10] m² (default) | 1-by-n vector

Vector of opening area values for the tabular parameterization of opening area. The vector elements must correspond one-to-one to the values in the **Pressure differential vector** parameter. Area vectors for normally open valves list elements in descending order. Area vectors for normally closed valves list elements in ascending order.

The opening area vector must have the same number of elements as the **Pressure differential vector**. Linear interpolation is employed between table data points.

Dependencies

To enable this parameter, set **Set pressure control** to Constant and **Opening parametrization** to Tabulated data.

Cross-sectional area at ports A and B — Area at valve entry or exit

inf m² (default) | positive scalar

Cross-sectional area at the entry and exit ports **A** and **B**. These areas are used in the pressure-flow rate equation that determines mass flow rate through the valve.

Discharge coefficient — Discharge coefficient

0.64 (default) | positive scalar

Correction factor accounting for discharge losses in theoretical flows. The default discharge coefficient for a valve in Simscape Fluids is 0.64.

Critical Reynolds number — Upper Reynolds number limit for laminar flow

150 (default) | positive scalar

Upper Reynolds number limit for laminar flow through the valve.

Pressure recovery – Whether to account for pressure increase in area expansions

Off (default) | On

Select to account for pressure increase when fluid flows from a region of a smaller cross-sectional area to a region of larger cross-sectional area.

Smoothing factor – Numerical smoothing factor

0.01 (default) | positive scalar in the range of [0,1]

Continuous smoothing factor that introduces a layer of gradual change to the flow response when the valve is in near-open or near-closed positions. Set this value to a nonzero value less than one to increase the stability of your simulation in these regimes.

Opening dynamics – Whether to account for flow response to valve opening

Off (default) | On

Select to account for transient effects to the fluid system due to the valve opening. When **Opening dynamics** is set to On, the block approximates the opening conditions by introducing a first-order lag in the flow response.

Opening time constant – Valve opening time constant

0.1 s (default) | positive scalar

Constant that captures the time required for the fluid to reach steady-state when opening or closing the valve from one position to another. This parameter impacts the modeled opening dynamics.

Dependencies

To enable this parameter, set **Opening dynamics** to On.

Faults**Enable faults – Fault option**

Off (default) | On

Enable externally or temporally triggered faults. When faulting occurs, the valve area normally set by the opening parameterization will be set to the value specified in the **Opening area when faulted** parameter.

Opening area when faulted – Set faulted characteristics

Closed (default) | Open | Maintain last value

Sets the faulted valve type. You can choose for the valve to seize when the valve is opened, closed, or at the area when faulting is triggered.

Dependencies

To enable this parameter, set **Enable faults** to On.

Fault trigger – External or temporal trigger option

Temporal (default) | External

Whether a fault trigger occurs due to an external event or at a specified time.

When set to External, port **Tr** is enabled. A physical signal at port **Tr** that is greater than 0.5 triggers faulting.

When set to **Temporal**, when the **Simulation time for fault event** is reached, the valve area will be set to the value specified in the **Opening area when faulted** parameter.

Dependencies

To enable this parameter, set **Enable faults** to On.

Simulation time for fault event – Time at which faulting is triggered

5 s (default) | positive scalar

When the **Simulation time for fault event** is reached, the valve area is set to the value specified in the **Opening area when faulted** parameter.

Dependencies

To enable this parameter, set **Enable faults** to On and **Fault trigger** to **Temporal**.

See Also

Pressure-Compensated Flow Control Valve (IL) | Pressure-Reducing 3-Way Valve (IL) | Pressure-Reducing Valve (IL) | Pressure Relief Valve (IL)

Introduced in R2020a

Pressure Reducing 3-Way Valve

Composite valve comprising the functions of pressure reducing and relief valves

Library: Simscape / Fluids / Hydraulics (Isothermal) / Valves / Pressure Control Valves



Description

The Pressure Reducing 3-Way Valve block models the flow through a valve that constricts and, if necessary, vents (via a separate line) so as to maintain a preset pressure differential between its outlet (port **A**) and its surroundings (**T**, the vent). The valve combines the functions of two more elementary valves, one a pressure-reducing valve, the other a pressure-relief valve.

The pressure-reducing valve runs between the inlet (**P**) and the outlet (**A**). It is normally open but closes as needed to combat pressure fluctuations upstream of the outlet. The pressure-relief valve runs between the outlet (**A**) and the vent (**T**). It is normally closed but opens if the outlet pressure should exceed (by a specified transition amount) the pressure regulation range of the pressure-reducing valve.

The valve opening areas are functions of the pressure differential from port **A** to port **T**—either directly proportional to it or general (tabulated) functions of it. The opening areas can each vary up to a point—the limit of the respective valve regulation range—beyond which the valve is saturated at full capacity and unable to counteract any additional pressure rises.

Valve Opening

The opening area calculation depends on the valve parameterization selected for the block: either Linear area-opening relationship or Tabulated data - Area vs. pressure.

Linear Parameterization

If the **Valve parameterization** block parameter is in the default setting of Linear area-opening relationship, the opening area of the pressure-reducing valve (**P-A**) is computed as:

$$S_{PA} = \frac{S_{Max} + S_{Leak}}{2} - \frac{S_{Max} - S_{Leak}}{2} \tanh \left[\frac{\lambda (\Delta p_{AT} - \Delta p_{Reg})}{\Delta p_{Reg}/2} \right],$$

where the \tanh term serves to smooth the transitions to the fully open and fully closed valve positions. In the equation:

- S_{Max} is the value specified in the **Maximum passage area** block parameter.
- S_{Leak} is the value specified in the **Leakage area** block parameter.
- λ is the value of the **Valve opening adjustment coefficient** block parameter, a measure of the smoothing to apply to the valve transitions. The smaller the value, the smoother the transition.
- Δp_{Reg} is the value specified in the **Valve regulation range** block parameter.

- Δp_{Rdn} is the midpoint of the pressure regulation range of the pressure-reducing valve:

$$\Delta p_{Rdn} = \Delta p_{Set} + \frac{\Delta p_{Reg}}{2},$$

with Δp_{Set} being the value of the **Reducing valve pressure setting** block parameter.

The opening area of the pressure-relief valve (**A-T**) is likewise computed as:

$$S_{AT} = \frac{S_{Max} + S_{Leak}}{2} + \frac{S_{Max} - S_{Leak}}{2} \tanh\left(\frac{\lambda(\Delta p_{AT} - \Delta p_{Rif})}{\Delta p_{Reg}/2}\right),$$

where Δp_{Rif} is the midpoint of the pressure regulation range of the pressure-relief valve:

$$\Delta p_{Rif} = \Delta p_{Set} + \Delta p_{Reg} + \Delta p_{Tran} + \frac{\Delta p_{Reg}}{2},$$

with Δp_{Tran} being the transition pressure differential—that required for the pressure-relief valve to open after the pressure-reducing valve has fully closed. This value is obtained from the **Transition pressure** block parameter.

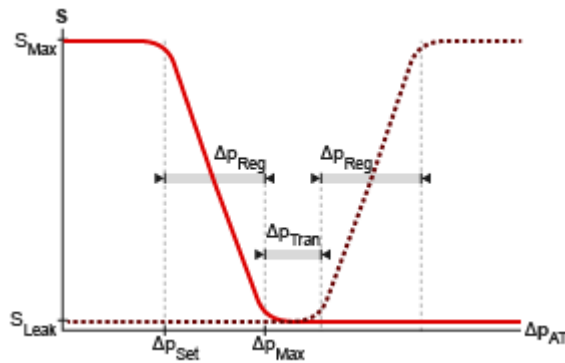

Opening area in the Linear area-opening relationship parameterization

Tabulated Parameterization

If the **Valve parameterization** block parameter is set to Tabulated data - Area vs. pressure, the valve opening areas are computed as:

$$S = S(\Delta p_{AT}),$$

where S_{AT} is a tabulated function constructed from the **Pressure drop vector** and **Opening area vector** block parameters. The function is based on linear interpolation (for points within the data range) and nearest-neighbor extrapolation (for points outside the data range). The leakage and maximum opening areas are the minimum and maximum values of the **Valve opening area vector** block parameter.

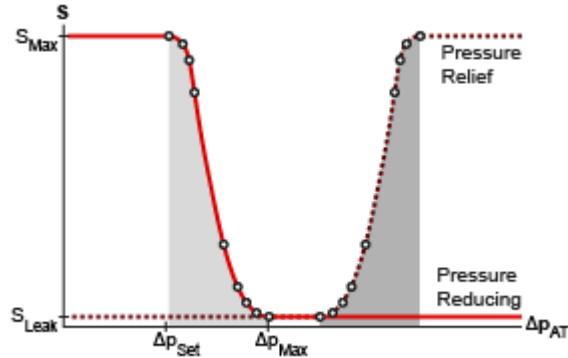

Opening area in the Tabulated data - Area vs. pressure parameterization

Opening Dynamics

By default, the valve opening dynamics are ignored. The valves are each assumed to respond instantaneously to changes in the pressure drop, without time lag between the onset of a pressure disturbance and the increased valve opening that the disturbance produces. If such time lags are of consequence in a model, you can capture them by setting the **Opening dynamics** block parameter to Include valve opening dynamics. The valves then open each at a rate given by the expression:

$$\dot{S} = \frac{S(\Delta p_{SS}) - S(\Delta p_{In})}{\tau},$$

where τ is a measure of the time needed for the instantaneous opening area (subscript In) to reach a new steady-state value (subscript SS).

Leakage Area

The primary purpose of the leakage area of a closed valve is to ensure that at no time does a portion of the hydraulic network become isolated from the remainder of the model. Such isolated portions reduce the numerical robustness of the model and can slow down simulation or cause it to fail. Leakage is generally present in minuscule amounts in real valves but in a model its exact value is less important than it being a small number greater than zero. The leakage area is obtained from the block parameter of the same name.

Valve Flow Rates

The causes of the pressure losses incurred in the passages of the composite valve are ignored in the block. Whatever their natures—sudden area changes, flow passage contortions—only their cumulative effect is considered during simulation. This effect is captured in the block by the discharge coefficient, a measure of the flow rate through a valve relative to the theoretical value that it would have in the ideal case. The flow rates through each of the elementary valves are defined as:

$$q = C_D S \sqrt{\frac{2}{\rho} \frac{\Delta p}{[(\Delta p)^2 + p_{crit}^2]^{1/4}}},$$

where:

- q is the volumetric flow rate through the valve (**P-A** or **A-T**).
- C_D is the value of the **Discharge coefficient** block parameter.

- S is the opening area of the valve (S_{PA} or S_{AT}).
- Δp is the pressure drop across the valve (Δp_{PA} or Δp_{AT}).
- p_{Crit} is the pressure differential at which the flow shifts between the laminar and turbulent flow regimes.

The calculation of the critical pressure depends on the setting of the **Laminar transition specification** block parameter. If this parameter is in the default setting of By pressure ratio:

$$p_{\text{Crit}} = (p_{\text{Atm}} + p_{\text{Avg}})(1 - \beta_{\text{Crit}}),$$

where:

- p_{Atm} is the atmospheric pressure (as defined for the corresponding hydraulic network).
- p_{Avg} is the average of the gauge pressures at the ports (**P** and **A** or **A** and **T**).
- β_{Crit} is the value of the **Laminar flow pressure ratio** block parameter.

If the **Laminar transition specification** block parameter is instead set to By Reynolds number:

$$p_{\text{Crit}} = \frac{\rho}{2} \left(\frac{\text{Re}_{\text{Crit}} \nu}{C_D D_H} \right)^2,$$

where:

- Re_{Crit} is the value of the **Critical Reynolds number** block parameter.
- ν is the kinematic viscosity specified for the hydraulic network.
- D_H is the instantaneous hydraulic diameter:

$$D_H = \sqrt{\frac{4S}{\Pi}}.$$

Ports

Conserving

A – Valve outlet

hydraulic (isothermal liquid)

Opening through which the flow can exit the valve.

P – Valve inlet

hydraulic (isothermal liquid)

Opening through which the flow can enter the valve.

T – Valve vent

hydraulic (isothermal liquid)

Opening through which the flow can vent from the valve.

Parameters

Opening area parameterization — Method by which to calculate the opening area of the valve

Linear area-opening relationship (default) | Tabulated data - Area vs. pressure

Method by which to calculate the opening area of the valve. The default setting prescribes a linear relationship between the opening area of the valve and the pressure drop between the outlet and the vent opening. The alternative setting allows for a general, nonlinear relationship to be specified in tabulated form.

Maximum passage area — Opening areas of the P-A and A-T valves in the fully open position

$1e-4 \text{ m}^2$ (default) | positive scalar in units of area

Opening area of each valve when fully open. The pressure-reducing and pressure-relief valves are assumed to be identical in size. See the block description for the pressure conditions under which the valves can each be said to be fully open.

Dependencies

This parameter is active when the **Opening area parameterization** block parameter is set to Linear area-pressure relationship.

Reducing valve pressure setting — Pressure from port A to port T at which the reducing valve begins to close

$6e5 \text{ Pa}$ (default) | positive scalar in units of pressure

Pressure differential from port **A** to port **T** that the composite valve is to maintain. The pressure-reducing valve closes in proportion to the pressure differential if its value should exceed that specified here. The pressure-relief valve opens in proportion to the same if its value should exceed, by an amount given by the **Transition pressure** block parameter, that needed to fully close the reducing valve.

Dependencies

This parameter is active when the **Opening area parameterization** block parameter is set to Linear area-pressure relationship.

Valve regulation range — Pressure drop interval over which the valves are each designed to operate

$1.5e5 \text{ Pa}$ (default) | positive scalar in units of pressure

Pressure differential interval over which the valves are each designed to operate. This interval spans those pressures over which the opening area changes between its minimum and maximum values. The value specified here applies to both the pressure-reducing and pressure-relief valves.

Dependencies

This parameter is active when the **Opening area parameterization** block parameter is set to Linear area-pressure relationship.

Transition pressure — Pressure interval between the final closing of the reducing valve and the first opening of the relief valve

$2e5 \text{ Pa}$ (default) | positive scalar in units of pressure

Pressure differential in excess of that required to fully close the pressure-reducing valve at which the pressure-relief valve first opens. The greater the transition pressure, the greater the lag between the closing of the pressure-reducing valve and the opening of its pressure-relief counterpart.

Dependencies

This parameter is active when the **Opening area parameterization** block parameter is set to Linear area-pressure relationship.

Valve flow discharge coefficient — Empirical factor defined as the ratio of actual to ideal mass flow rates

0.7 (default) | positive unitless scalar

Ratio of the actual flow rate through the valve to the theoretical value that it would have in an ideal valve. This semi-empirical parameter measures the flow allowed through the valve: the greater its value, the greater the flow rate. Refer to the valve data sheet, if available, for this parameter. The value specified here is shared by both pressure-reducing and pressure-relief valves.

Valve leakage area — Opening area of the valve in the maximally closed position

1e-10 m² (default) | positive scalar in units of area

Opening area of a valve in the fully closed position, when only internal leakage between its respective ports remains. The leakage area is the same in the pressure-reducing and pressure-relief valves. This parameter serves primarily to ensure that closure of the valve does not cause portions of the hydraulic network to become isolated. The exact value specified here is less important than its being a small number greater than zero.

Dependencies

This parameter is active when the **Opening area parameterization** block parameter is set to Linear area-pressure relationship.

Valve opening adjustment coefficient — Smoothing factor for easing the transition to the fully open or fully closed position

1 (default) | positive unitless scalar

Smoothing factor for easing the transition to the fully open or fully closed valve position. The smoothing enhances the numerical robustness of the model, helping to avoid numerical errors due to discontinuities and simulation slowdowns due to zero crossings. Use this parameter to scale the widths of the smoothed regions. The smaller the value, the broader the transition.

Dependencies

This parameter is active when the **Opening area parameterization** block parameter is set to Linear area-pressure relationship.

Pressure differential vector for reducing valve — Vector of pressure drops at which to tabulate the valve opening areas

[6.06E5 : .06E5 : 6.24E5] Pa (default) | vector of positive numbers in units of pressure

Vector of pressure drops from port **P** to port **A** at which to specify the opening area of the valve. The vector elements must increase monotonically from left to right. This order is important when specifying the **Opening area vector for reducing valve** block parameter.

The block uses this data to construct a lookup table by which to determine from the pressure differential the reducing-valve opening area. Data is handled with linear interpolation (within the tabulated data range) and nearest-neighbor extrapolation (outside of the range).

Dependencies

This parameter is active when the **Opening area parameterization** block parameter is set to Tabulated data - Area vs. pressure.

Opening area vector for reducing valve – Vector of opening areas at the specified pressure differential breakpoints

[.9168, .69, .31, .0832] E-4 m² (default) | vector of positive numbers in units of area

Vector of opening areas corresponding to the breakpoints defined in the **Pressure differential vector for reducing valve** block parameter. The vector elements must decrease monotonically from left to right (with increasing pressure). For best results, avoid regions of flattened slope.

The block uses this data to construct a lookup table by which to determine from the pressure differential the reducing-valve opening area. Data is handled with linear interpolation (within the tabulated data range) and nearest-neighbor extrapolation (outside of the range).

Dependencies

This parameter is active when the **Opening area parameterization** block parameter is set to Tabulated data - Area vs. pressure.

Pressure differential vector for relief valve – Vector of pressure drops at which to tabulate the valve opening areas

[6.2, 6.26, 6.32, 6.38] E5 Pa (default) | vector of positive numbers in units of pressure

Vector of pressure drops from port **A** to port **T** at which to specify the opening area of the valve. The vector elements must increase monotonically from left to right. This order is important when specifying the **Opening area vector for relief valve** block parameter.

The block uses this data to construct a lookup table by which to determine from the pressure differential the reducing-valve opening area. Data is handled with linear interpolation (within the tabulated data range) and nearest-neighbor extrapolation (outside of the range).

Dependencies

This parameter is active when the **Opening area parameterization** block parameter is set to Tabulated data - Area vs. pressure.

Opening area vector for relief valve – Vector of opening areas at the specified pressure differential breakpoints

[.9168, .69, .31, .0832] E-4 m² (default) | vector of positive numbers in units of area

Vector of opening areas corresponding to the breakpoints defined in the **Pressure differential vector for relief valve** block parameter. The vector elements must decrease monotonically from left to right (with increasing pressure). For best results, avoid regions of flattened slope.

The block uses this data to construct a lookup table by which to determine from the pressure differential the reducing-valve opening area. Data is handled with linear interpolation (within the tabulated data range) and nearest-neighbor extrapolation (outside of the range).

Dependencies

This parameter is active when the **Opening area parameterization** block parameter is set to Tabulated data - Area vs. pressure.

Laminar transition specification — Parameter in terms of which to define the boundary between laminar and turbulent regimes

Pressure ratio (default) | Reynolds number

Parameter in terms of which to specify the boundary between the laminar and turbulent flow regimes. The pressure ratio of the default parameterization is defined as the gauge pressure at the outlet divided by the same at the inlet.

Laminar flow pressure ratio — Pressure ratio at which the flow transitions between laminar and turbulent regimes

0.999 (default) | positive unitless scalar

Pressure ratio at which the flow is assumed to transition between laminar and turbulent regimes. The pressure ratio is defined as the gauge pressure at the outlet divided by the same at the inlet. The transition is assumed to be smooth and centered on this value.

Dependencies

This parameter is active when the **Laminar transition specification** block parameter is set to Pressure ratio.

Critical Reynolds number — Reynolds number at the boundary between laminar and turbulent flow regimes

12 (default) | positive unitless scalar

Reynolds number at which the flow is assumed to transition between laminar and turbulent regimes.

Dependencies

This parameter is active when the **Laminar transition specification** block parameter is set to Reynolds number.

Opening dynamics — Choice of whether to capture the opening dynamics of the valve

Do not include valve opening dynamics (default) | Include valve opening dynamics

Choice of whether to capture the opening dynamics of the valve. Selecting **Include valve opening dynamics** causes the valve to open gradually, so as to approach its new steady-state area over a small time span. The characteristic time for such transitions is given in the **Opening time constant** block parameter.

Setting this parameter to the alternative **Do not include valve opening dynamics** is equivalent to specifying a value of 0 for the opening time constant. The opening area is in this case assumed to reach its new steady-state value instantaneously.

Include opening dynamics to more accurately capture the behavior of a real valve. For best real-time simulation performance, use with a local solver or disable valve opening dynamics altogether.

Opening time constant — Characteristic time scale of the valve opening transitions

0.1 s (default) | positive scalar in units of time

Measure of the time taken by the valve to transition from its current opening area to a new steady-state value. The block uses this parameter to calculate the rate at which a valve is opening and from it the instantaneous opening area at the next time step.

Dependencies

This parameter is active when the **Opening dynamics** block parameter is set to Include valve opening dynamics.

Initial reducing valve area — Opening area of the reducing valve at the start of simulation

1e-9 m² (default) | positive scalar in units of area

Area normal to the direction of flow within the pressure-reducing valve at the start of simulation. The block uses this parameter to calculate the initial rate at which the pressure-reducing valve is opening and from it the instantaneous opening area at the next time step.

Dependencies

This parameter is active when the **Opening dynamics** block parameter is set to Include valve opening dynamics.

Initial relief valve area — Opening area of the relief valve at the start of simulation

1e-9 m² (default) | positive scalar in units of area

Area normal to the direction of flow within the pressure-relief valve at the start of simulation. The block uses this parameter to calculate the initial rate at which the pressure-relief valve is opening and from it the instantaneous opening area at the next time step.

Dependencies

This parameter is active when the **Opening dynamics** block parameter is set to Include valve opening dynamics.

Extended Capabilities**C/C++ Code Generation**

Generate C and C++ code using Simulink® Coder™.

See Also

Pressure Compensator | Pressure Reducing Valve | Pressure Relief Valve

Topics

“Upgrading Simscape Fluids Models Containing Hydraulics (Isothermal) Blocks”

Introduced in R2016a

Pressure-Reducing 3-Way Valve (IL)

Combined pressure-relief and pressure-reducing valve in isothermal system

Library: Simscape / Fluids / Isothermal Liquid / Valves & Orifices / Pressure Control Valves

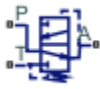

Description

The Pressure-Reducing 3-Way Valve (IL) is a combination of a pressure-relief and pressure-reducing valve. It maintains pressure at the valve outlet, port **A**, by restricting the inflow area at port **P** and venting the flow at port **T**.

Valve Functionality

Valve operation is triggered by comparing the pressure difference between port **T** and port **A** to a threshold, the set pressure. When the pressure between **T** and **A**, P_{control} , exceeds this set pressure, $P_{\text{set, reducing}}$, port **P** begins to close. A transition pressure range defines the pressures the valve experiences when both valves at ports **P** and **T** are closed. When the pressure difference between ports **A** and **T** exceeds the pressure transition range, port **T** opens. That is, $P_{\text{set, relief}} = P_{\text{set, reducing}} + P_{\text{range}} + P_{\text{transition}}$. The **Pressure regulation range** is specified for both the pressure-reducing and the pressure-relief valves. The valve parameters, such as **Leakage Area** and **Maximum Opening Area**, are the same for all ports.

To simulate pressure relief or pressure reduction with respect to another system element, see Pressure Compensator Valve (IL). To simulate pressure reduction between the valve outlet and atmosphere, see the Pressure-Reducing Valve (IL). To simulate pressure relief with respect to a valve or between the valve outlet and atmospheric pressure, see Pressure Relief Valve (IL).

Pressure Control

When $P_{\text{control}}, P_A - P_T$, exceeds the threshold pressure, $P_{\text{set, reducing}}$, the valve at port **P** begins to close. When the **Pressure transition range** is exceeded, or when $P_{\text{control}} > P_{\text{set, relief}}$, the valve at port **T** begins to open. Both valve closing and opening are parameterized in two ways:

- When **Set Pressure control** is set to **Controlled**, connect a pressure signal to port **Ps**, set the constant **Pressure regulation range**, and set the constant **Pressure transition range**. The pressure-reducing valve begins to close when P_{control} is greater than $P_{\text{set, reducing}}$ and below $P_{\text{max, reducing}}$. The relief valve response is triggered when P_{control} is greater than $P_{\text{set, relief}}$ and below $P_{\text{max, relief}}$. $P_{\text{max, relief}}$ is the sum of the **Pressure regulation range** and $P_{\text{set, relief}}$.
- When **Set Pressure control** is set to **Constant**, valve closing at port **P** is continuously regulated by either a linear or tabular parameterization. Similarly, relief valve opening at port **T** is parameterized linearly or by table lookup. An example of linear parameterization of the reduction valve (solid line) and relief valve (dotted line) is shown below.

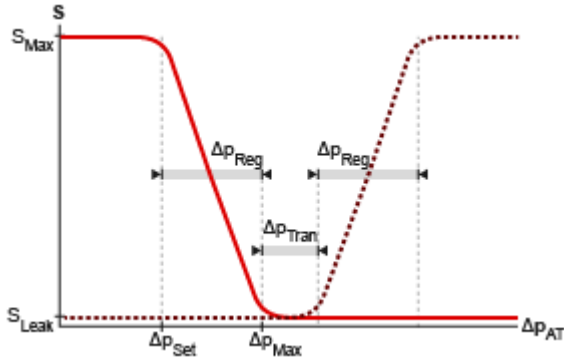

When the Tabulated data option is selected, $P_{set, reducing}$ and $P_{max, reducing}$ are the first and last parameters of the **Pressure differential vector for reducing valve**, respectively, and $P_{set, relief}$ and $P_{max, relief}$ are the first and last parameters of the **Pressure differential vector for relief valve**, respectively. An example of tabular parameterization of both the reducing and relieving valves are shown below.

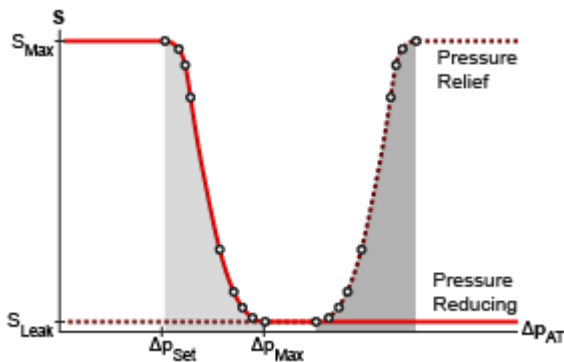

Mass Flow Rate Equation

Momentum is conserved through the valve:

$$\dot{m}_A + \dot{m}_{reducing} + \dot{m}_{relief} = 0.$$

The mass flow rate through the valves is calculated as:

$$\dot{m}_{reducing} = \frac{C_d A_{PA} \sqrt{2\bar{\rho}}}{\sqrt{PR_{loss, reducing} \left(1 - \left(\frac{A_{PA}}{A_{port}}\right)^2\right)}} \frac{\Delta p_{reducing}}{[\Delta p_{reducing}^2 + \Delta p_{crit, reducing}^2]^{1/4}},$$

$$\dot{m}_{relief} = \frac{C_d A_{AT} \sqrt{2\bar{\rho}}}{\sqrt{PR_{loss, relief} \left(1 - \left(\frac{A_{AT}}{A_{port}}\right)^2\right)}} \frac{\Delta p_{relief}}{[\Delta p_{relief}^2 + \Delta p_{crit, relief}^2]^{1/4}},$$

where:

- C_d is the **Discharge coefficient**.

- A is the instantaneous valve open area between ports **A** and **P** or **A** and **T**, as indicated by the subscript.
- A_{port} is the **Cross-sectional area at ports A, P & T**.
- $\bar{\rho}$ is the average fluid density.
- Δp is the valve pressure difference: $p_A - p_B$.

The critical pressure difference, Δp_{crit} , is the pressure differential associated with the **Critical Reynolds number**, Re_{crit} , the flow regime transition point between laminar and turbulent flow, which corresponds to either the pressure-reducing or pressure relief component of the valve:

$$\Delta p_{crit} = \frac{\pi \bar{\rho}}{8A} \left(\frac{\nu Re_{crit}}{C_d} \right)^2,$$

where A is either A_{PA} or A_{AT} , corresponding to the reducing or relief component of the valve, respectively.

Pressure loss describes the reduction of pressure in the valve due to a decrease in area. PR_{loss} is calculated as:

$$PR_{loss} = \frac{\sqrt{1 - \left(\frac{A}{A_{port}}\right)^2 (1 - C_d^2)} - C_d \frac{A}{A_{port}}}{\sqrt{1 - \left(\frac{A}{A_{port}}\right)^2 (1 - C_d^2)} + C_d \frac{A}{A_{port}}}.$$

Pressure recovery describes the positive pressure change in the valve due to an increase in area. If you do not wish to capture this increase in pressure, set **Pressure recovery** to Off. In this case, PR_{loss} is 1.

The opening area A is determined by the opening parameterization (for Constant valves only) of the reducing valve (**P** to **A**) or relief valve (**A** to **T**) and the valve opening dynamics.

Opening and Closing Parameterization

Linear parameterization of the valve area for the reducing valve is

$$A_{valve} = \hat{p}_{reducing}(A_{leak} - A_{max}) + A_{max},$$

and for the relief valve is

$$A_{valve} = \hat{p}_{relief}(A_{max} - A_{leak}) + A_{leak}.$$

The normalized pressure, \hat{p} , is

$$\hat{p} = \frac{p_{control} - p_{set}}{p_{max} - p_{set}},$$

where the set and maximum pressures are the respective reducing or relief valve settings.

At the extremes of the relief and reducing valve pressure ranges, you can maintain numerical robustness in your simulation by adjusting the block **Smoothing factor**. With a nonzero smoothing factor, a smoothing function is applied to every calculated pressure, but primarily influences the simulation at the extremes of these ranges.

When the **Smoothing factor**, f , is nonzero, a smoothed, normalized pressure is instead applied to the valve area:

$$\hat{p}_{smoothed} = \frac{1}{2} + \frac{1}{2}\sqrt{\hat{p}^2 + \left(\frac{f}{4}\right)^2} - \frac{1}{2}\sqrt{(\hat{p} - 1)^2 + \left(\frac{f}{4}\right)^2}.$$

In the **Tabulated data** parameterization, $A_{leak,PA}$ and $A_{max,PA}$ are the first and last parameters of the **Opening area vector reducing valve**, respectively, and $A_{leak,AT}$ and $A_{max,AT}$ are the first and last parameters of the **Opening area vector for relief valve**, respectively. The smoothed, normalized pressure is also used when the smoothing factor is nonzero with linear interpolation and nearest extrapolation.

Opening Dynamics

If **Opening dynamics** are modeled, a lag is introduced to the flow response to valve opening. A_{valve} becomes the dynamic opening or closing area, A_{dyn} ; otherwise, A_{valve} is the steady-state opening area. This area is specific to the reducing and relief components of the valve, A_{PA} or A_{AT} , respectively. The instantaneous change in dynamic opening area is calculated based on the **Opening time constant**, τ :

$$\dot{p}_{dyn} = \frac{p_{control} - p_{dyn}}{\tau}.$$

By default, **Opening dynamics** is set to **Off**.

Faulty Behavior

When faults are enabled, the reducing and relief valve open areas become stuck at a specified value in response to one of these triggers:

- Simulation time — Faulting occurs at a specified time.
- Simulation behavior — Faulting occurs in response to an external trigger. This exposes port **Tr**.

Three fault options are available in the **Valve areas when faulted** parameter:

- Reducing valve closed and relief valve open — The reducing valve freezes at its smallest value and the relief valve freezes at its largest value, depending on the **Opening parameterization**:
 - When **Opening parameterization** is set to **Linear**, the reducing valve area freezes at the **Leakage area** and the relief valve area freezes at the **Maximum opening area**.
 - When **Opening parameterization** is set to **Tabulated data**, the reducing valve area freezes at the first element of the **Opening area vector** and the relief valve area freezes at the last element of the **Opening area vector**.
- Reducing valve open and relief valve closed — The reducing valve freezes at its largest value and the relief valve freezes at its smallest value, depending on the **Opening parameterization**:
 - When **Opening parameterization** is set to **Linear**, the reducing valve area freezes at the **Maximum opening area** and the relief valve freezes at the **Leakage area**.
 - When **Orifice parameterization** is set to **Tabulated data**, the reducing valve area freezes at the last element of the **Opening area vector** and the relief valve area freezes at the first element of the **Opening area vector**.

- **Maintain last value** — The reducing and relief valve areas freeze at the open area when the trigger occurred.

Due to numerical smoothing at the extremes of the valve area, the minimum area applied is larger than the **Leakage area**, and the maximum is smaller than the **Maximum orifice area**, in proportion to the **Smoothing factor** value.

Once triggered, the valves remain at the faulted area for the rest of the simulation.

Assumptions and Limitations

Friction between the valve and fluid, the hydraulic force of the fluid on the valve components, and the effect of fluid inertia are neglected.

Port

Conserving

A — Liquid port

isothermal liquid

Liquid exit port of the valve.

P — Liquid port

isothermal liquid

Liquid entry port to the valve.

T — Liquid port

isothermal liquid

Liquid relief port of the valve.

Input

Ps — Controlled pressure differential

physical signal

Varying-signal set pressure for controlled valve operation.

Dependencies

To enable this port, set **Set pressure control** to **Controlled**.

Tr — External fault trigger

physical signal

Physical signal port for an external fault trigger. Triggering occurs when the value is greater than 0.5. There is no unit associated with the trigger value.

Dependencies

This port is visible when **Enable faults** is set to **On** and **Fault trigger** is set to **External**.

Parameters

Parameters

Set pressure control — Valve operation method

Constant (default) | Controlled

Valve operation method. A **Constant** valve opens or closes linearly over a fixed pressure regulation range and pressure transition or in accordance with tabulated pressure and opening area data that you provide. A **Controlled** valve opens or closes according to a variable set pressure signal at port **Pset** over a fixed pressure regulation and pressure transition range. The selected setting applies both to the reducing and relief valve operation.

Opening parameterization — Type of opening parameterization

Linear (default) | Tabulated data

Method of modeling the valve opening or closing. Valve opening is either parametrized linearly, which correlates the opening area to the provided pressure range, or by a table of values you provide that correlate the valve opening area to pressure differential data.

Dependencies

To enable this port, set **Set pressure control** to **Constant**.

Set pressure differential for reducing valve — Set pressure for valve closing at port P

0.6 MPa (default) | scalar

Pressure differential between port **T** and port **A**. When this set pressure differential is surpassed, the valve at port **P** begins to close. The closing is parametrized linearly or by lookup table as defined in the **Opening parameterization**.

Pressure regulation range — Valve operational pressure range

3e-2 MPa (default) | scalar

Operational pressure range of the reducing valve. The pressure regulation range lies between the **Set pressure differential** and the maximum valve operating pressure. At the end of the **Pressure regulation range**, the pressure-reducing valve is closed and the **Pressure transition range** begins.

Dependencies

To enable this parameter, set

- **Set pressure control** to **Controlled**, or
- **Set pressure control** to **Constant** and **Opening parameterization** to **Linear**.

Pressure transition range — Pressure range of valve with ports P and T closed

2e-2 MPa (default) | scalar

Pressure range of the 3-way valve. This parameter defines the pressure range, which begins at the end of the **Pressure regulation range**, over which both ports **P** and **T** are closed. Below this range, the reducing valve at port **P** is open to flow, and above this range, the relief valve at port **T** opens.

Dependencies

To enable this parameter, set either:

- **Set pressure control** to Controlled
- **Set pressure control** to Constant and **Opening parameterization** to Linear

Maximum opening area — Maximum opening area of ports

1e-4 m² (default) | positive scalar

Cross-sectional area of the valve (**P-A** or **A-T**) in its fully-open position.

Dependencies

To enable this parameter, set either:

- **Set pressure control** to Controlled
- **Set pressure control** to Constant and **Opening parameterization** to Linear

Leakage area — Gap area when in fully closed position

1e-10 m² (default) | positive scalar

Sum of all gaps when the valve is in fully closed position. Any area smaller than this value is saturated to the specified leakage area. This contributes to numerical stability by maintaining continuity in the flow.

Dependencies

To enable this parameter, set either:

- **Set pressure control** to Controlled
- **Set pressure control** to Constant and **Opening parameterization** to Linear

Pressure differential vector for reducing valve — Differential pressure values for tabular parameterization of reducing valve

0.6 : 0.02 : 0.7 MPa (default) | 1-by-n vector

Vector of pressure differential values for the tabular parameterization of opening area. The vector elements correspond one-to-one to the values in the **Opening area vector reducing valve** parameter. Pressure differential vector values are listed in ascending order and must have the same number of elements as the **Opening area vector reducing valve** parameter. Linear interpolation is employed between table data points.

Dependencies

To enable this parameter, set **Set pressure control** to Constant and **Opening parameterization** to Tabulated data.

Opening area vector reducing valve — Vector of valve opening areas for tabular parameterization of reducing valve

[1e-05, 8e-06, 6e-06, 4e-06, 2e-06, 1e-10] m² (default) | 1-by-n vector

Vector of opening area values for the tabular parameterization of opening area. The vector elements must correspond one-to-one to the values in the **Pressure differential vector for reducing valve** parameter. Areas are listed in descending order. Linear interpolation is employed between table data points.

Dependencies

To enable this parameter, set **Set pressure control** to Constant and **Opening parameterization** to Tabulated data.

Pressure differential vector for relief valve – Differential pressure values for tabular parameterization of relief valve

0.68 : 0.02 : 0.78 MPa (default) | 1-by-*n* vector

Vector of pressure differential values for the tabular parameterization of opening area. The vector elements correspond one-to-one to the values in the **Opening area vector relief valve** parameter. Pressure differential vector values are listed in ascending order and must have the same number of elements as the **Opening area vector relief valve** parameter. Linear interpolation is employed between table data points.

Dependencies

To enable this parameter, set **Set pressure control** to Constant and **Opening parameterization** to Tabulated data.

Opening area vector for relief valve – Valve opening areas for tabular parameterization of relief valve

[1e-10, 2e-06, 4e-06, 6e-06, 8e-06, 1e-05] m² (default) | 1-by-*n* vector

Vector of opening area values for the tabular parameterization of opening area. The vector elements must correspond one-to-one to the values in the **Pressure differential vector for relief valve** parameter. Areas are listed in ascending order. Linear interpolation is employed between table data points.

Dependencies

To enable this parameter, set **Set pressure control** to Constant and **Opening parameterization** to Tabulated data.

Cross-sectional area at ports A, P & T. – Orifice area at conserving ports

inf m² (default) | positive scalar

Cross-sectional area at the entry and exit ports **A**, **P**, and **T**. This area is used in the pressure-flow rate equation that determines the mass flow rate through the orifice.

Discharge coefficient – Discharge coefficient

0.64 (default) | positive scalar

Correction factor accounting for discharge losses in theoretical flows. The default discharge coefficient for a valve in Simscape Fluids is 0.64.

Critical Reynolds number – Upper Reynolds number limit for laminar flow

150 (default) | positive scalar

Upper Reynolds number limit for laminar flow through the valve.

Smoothing factor – Numerical smoothing factor

0.01 (default) | positive scalar in the range of [0,1]

Continuous smoothing factor that introduces a layer of gradual change to the flow response when the valve is in near-open or near-closed positions. Set this value to a nonzero value less than one to increase the stability of your simulation in these regimes.

Pressure recovery – Whether to account for pressure increase in area expansions

Off (default) | On

Accounts for pressure increase when fluid flows from a region of smaller cross-sectional area to a region of larger cross-sectional area. This increase in pressure is not captured when **Pressure recovery** is set to Off.

Opening dynamics – Whether to introduce flow lag due to orifice opening

Off (default) | On

Accounts for transient effects to the fluid system due to the valve opening. Setting **Opening dynamics** to On approximates the opening conditions by introducing a first-order lag in the flow response. The **Opening time constant** also impacts the modeled opening dynamics.

Reducing valve initial opening area – Open area at port P at the start of the simulation $1e-4 \text{ m}^2$ (default) | positive scalar

Initial cross-sectional area at port **P** at the time of dynamic opening. This value is used to calculate the instantaneous opening area for the dynamic opening between **P** and **A** at the following time step.

Dependencies

To enable this parameter, set **Opening dynamics** to On.

Relief valve initial opening area – Open area at port T at the start of the simulation $1e-10 \text{ m}^2$ (default) | positive scalar

Initial cross-sectional area at port **T** of opening at the time of dynamic opening. This value is used to calculate the instantaneous opening area for the dynamic opening between **A** and **T** at the following time step.

Dependencies

To enable this parameter, set **Opening dynamics** to On.

Opening time constant – Valve opening time constant

0.1 s (default) | positive scalar

Constant that captures the time required for the fluid to reach steady-state when opening or closing the valve from one position to another. This parameter impacts the modeled opening dynamics.

Dependencies

To enable this parameter, set **Opening dynamics** to On.

Faults**Enable faults – Fault option**

Off (default) | On

Enable externally or temporally triggered faults. When faulting occurs, the valve area normally set by the opening parameterization will be set to the value specified in the **Opening area when faulted** parameter.

Valve areas when faulted – Set faulted characteristics

Reducing valve closed and relief valve open (default) | Reducing valve open and relief valve closed | Maintain last value

Sets the faulted valve type. You can choose for the valve to seize when the valves are opened, closed, or at the area when faulting is triggered.

Dependencies

To enable this parameter, set **Enable faults** to On.

Fault trigger – External or temporal trigger option

Temporal (default) | External

Whether a fault trigger occurs due to an external event or at a specified time.

When set to **External**, port **Tr** is enabled. A physical signal at port **Tr** that is greater than 0.5 triggers faulting.

When set to **Temporal**, when the **Simulation time for fault event** is reached, the valve area will be set to the value specified in the **Opening area when faulted** parameter.

Dependencies

To enable this parameter, set **Enable faults** to On.

Simulation time for fault event – Time at which faulting is triggered

5 s (default) | positive scalar

When the **Simulation time for fault event** is reached, the valve area is set to the value specified in the **Opening area when faulted** parameter.

Dependencies

To enable this parameter, set **Enable faults** to On and **Fault trigger** to **Temporal**.

See Also

Pressure-Compensated 3-Way Flow Control Valve (IL) | Pressure Compensator Valve (IL) | Pressure-Reducing Valve (IL) | Pressure Relief Valve (IL) | Counterbalance Valve (IL)

Introduced in R2020a

Pressure Reducing Valve

Valve used to reduce pressure to a specified value

Library: Simscape / Fluids / Hydraulics (Isothermal) / Valves / Pressure Control Valves



Description

The Pressure Reducing Valve block models the flow through a valve that constricts so as to maintain a preset gauge pressure at its outlet (port **B**). The normally open valve contracts when the outlet pressure, measured against atmospheric pressure, exceeds the valve pressure setting. The drop in opening area is a function of the outlet pressure—proportional to it in a linear parameterization (the block default) or a general function of it in a tabulated parameterization. The valve serves its purpose until it hits the limit of its pressure regulation range—a point at which the valve is fully closed and the outlet pressure can again rise unabated.

Valve Opening

The figures show the opening characteristics of the valve. In the default valve parameterization, the opening area (S) drops linearly with the outlet pressure (p_B) with its value ranging from a maximum in the fully open position (S_{Max}) to a minimum in the fully closed position (S_{Leak}). The drop occurs over a pressure range stretching from the valve pressure setting (p_{Set}) to a maximum equal to the sum of the valve regulation range (p_{Reg}) and the valve pressure setting.

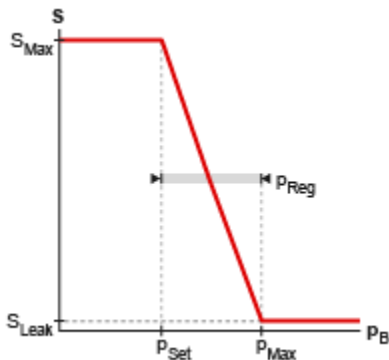

Opening area in the Linear area-opening relationship parameterization

In the optional tabulated parameterization, the opening area is a general function of the outlet pressure, with its value dropping from a maximum (S_{Max}) to a minimum (S_{Min}) contained in the tabulated data. The maximum opening occurs at the minimum pressure (p_{Min}) contained in the data and the minimum opening at the maximum pressure (p_{Max}). Calculations are based on linear interpolation (between the tabulated bounds) and nearest-neighbor extrapolation (outside of those bounds).

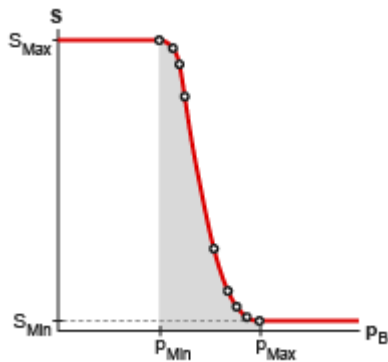

Opening area in the Tabulated data - Area vs. pressure parameterization

Composite Diagram

This block is a composite component with a Pressure Compensator block connected as follows: its sensor port **X** connected to its outlet (port **B**) and its sensor port **Y** connected to a hydraulic reference. The hydraulic reference is by definition at atmospheric pressure as defined for the entire hydraulic network. For detailed block calculations see the Pressure Compensator block (noting that quantities at port **X** are defined at port **B** and those at port **Y** are defined at reference conditions).

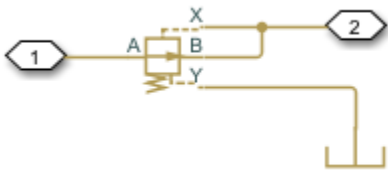

Composite model of the pressure relief valve

Ports

Conserving

A – Valve inlet

hydraulic (isothermal liquid)

Opening through which the flow can enter the valve.

B – Valve outlet

hydraulic (isothermal liquid)

Opening through which the flow can exit the valve.

Parameters

Opening area parameterization – Method by which to calculate the opening area of the valve

Linear area-opening relationship (default) | Tabulated data - Area vs. pressure

Method by which to calculate the opening area of the valve. The default setting prescribes a linear relationship between the opening area of the valve and the pressure drop between its sensor ports. The alternative setting allows for a general, nonlinear relationship to be specified in tabulated form.

Maximum passage area — Opening area of the valve in the fully open position

1e-4 m² (default) | positive scalar in units of area

Opening area of the valve in the fully open position. The valve is fully open if the pressure at port **B** relative to a hydraulic reference at atmospheric pressure is less than the value specified in the **Valve pressure setting** block parameter.

Dependencies

This parameter is active when the **Opening area parameterization** block parameter is set to Linear area-pressure relationship.

Valve pressure setting — Pressure drop to maintain at port B relative to a hydraulic reference

30e5 Pa (default) | positive scalar in units of pressure

Gauge pressure that the valve is to maintain at port **B**. The valve closes in proportion to the gauge pressure if it should exceed the value specified here. If the pressure drop is less than this value, the opening area is that specified in the **Maximum passage area** block parameter.

Dependencies

This parameter is active when the **Opening area parameterization** block parameter is set to Linear area-pressure relationship.

Valve regulation range — Pressure interval over which the valve is designed to operate

1.5e5 Pa (default) | positive scalar in units of pressure

Pressure interval over which the valve is designed to operate. This interval stretches from the largest pressure at which the valve is fully open to the lowest pressure at which the valve is fully closed. Only within this range is the valve capable of maintaining the specified pressure setting.

Dependencies

This parameter is active when the **Opening area parameterization** block parameter is set to Linear area-pressure relationship.

Discharge coefficient — Empirical factor defined as the ratio of actual to ideal mass flow rates

0.7 (default) | positive unitless scalar

Ratio of the actual flow rate through the valve to the theoretical value that it would have in an ideal valve. This semi-empirical parameter measures the flow allowed through the valve: the greater its value, the greater the flow rate. Refer to the valve data sheet, if available, for this parameter.

Leakage area — Opening area of the valve in the maximally closed position

1e-10 m² (default) | positive scalar in units of area

Opening area of the valve in the fully closed position, when only internal leakage between its ports remains. This parameter serves primarily to ensure that closure of the valve does not cause portions of the thermal liquid network to become isolated. The exact value specified here is less important than its being a small number greater than zero.

Dependencies

This parameter is active when the **Opening area parameterization** block parameter is set to Linear area-pressure relationship.

Pressure differential vector — Vector of pressure drops at which to tabulate the valve opening areas

[30.15E5 : 15E3 : 31.35E5] Pa (default) | vector of positive numbers in units of pressure

Vector of gauge pressures at port **B** at which to specify the opening area of the valve. The vector elements must increase monotonically from left to right. This order is important when specifying the **Opening area vector** block parameter.

The block uses this data to construct a lookup table by which to determine from the gauge pressure at port **B** the valve opening area. Data is handled with linear interpolation (within the tabulated data range) and nearest-neighbor extrapolation (outside of the range).

Dependencies

This parameter is active when the **Opening area parameterization** block parameter is set to Tabulated data - Area vs. pressure.

Opening area vector — Vector of opening areas at the specified pressure differential breakpoints

[9E-5 : -1 : 1E-5] m² (default) | vector of positive numbers in units of area

Vector of opening areas corresponding to the breakpoints defined in the **Pressure differential vector** block parameter. The vector elements must decrease monotonically from left to right (with increasing pressure). For best results, avoid regions of flattened slope.

The block uses this data to construct a lookup table by which to determine from the gauge pressure at port **B** the valve opening area. Data is handled with linear interpolation (within the tabulated data range) and nearest-neighbor extrapolation (outside of the range).

Dependencies

This parameter is active when the **Opening area parameterization** block parameter is set to Tabulated data - Area vs. pressure.

Laminar transition specification — Parameter in terms of which to define the boundary between laminar and turbulent regimes

Pressure ratio (default) | Reynolds number

Parameter in terms of which to specify the boundary between the laminar and turbulent flow regimes. The pressure ratio of the default parameterization is defined as the gauge pressure at the outlet divided by the same at the inlet.

Laminar flow pressure ratio — Pressure ratio at which the flow transitions between laminar and turbulent regimes

0.999 (default) | positive unitless scalar

Pressure ratio at which the flow is assumed to transition between laminar and turbulent regimes. The pressure ratio is defined as the gauge pressure at the outlet divided by the same at the inlet. The transition is assumed to be smooth and centered on this value.

Dependencies

This parameter is active when the **Laminar transition specification** block parameter is set to `Pressure ratio`.

Critical Reynolds number — Reynolds number at the boundary between laminar and turbulent flow regimes

12 (default) | positive unitless scalar

Reynolds number at which the flow is assumed to transition between laminar and turbulent regimes.

Dependencies

This parameter is active when the **Laminar transition specification** block parameter is set to `Reynolds number`.

Opening dynamics — Choice of whether to capture the opening dynamics of the valve

`Do not include valve opening dynamics (default)` | `Include valve opening dynamics`

Choice of whether to capture the opening dynamics of the valve. Selecting `Include valve opening dynamics` causes the valve to open gradually, so as to approach its new steady-state area over a small time span. The characteristic time for such transitions is given in the **Opening time constant** block parameter.

Setting this parameter to the alternative `Do not include valve opening dynamics` is equivalent to specifying a value of 0 for the opening time constant. The opening area is in this case assumed to reach its new steady-state value instantaneously.

Include opening dynamics to more accurately capture the behavior of a real valve. For best real-time simulation performance, use with a local solver or disable valve opening dynamics altogether.

Opening time constant — Characteristic time scale of the valve opening transitions

0.1 s (default) | positive scalar in units of time

Measure of the time taken by the valve to transition from its current opening area to a new steady-state value. The block uses this parameter to calculate the rate at which a valve is opening and from it the instantaneous opening area at the next time step.

Dependencies

This parameter is active when the **Opening dynamics** block parameter is set to `Include valve opening dynamics`.

Initial area — Opening area at the start of simulation

1e-12 m² (default) | positive scalar in units of area

Area normal to the direction of flow within the valve at the start of simulation. The block uses this parameter to calculate the initial rate at which the valve is opening and from it the instantaneous opening area at the next time step.

Dependencies

This parameter is active when the **Opening dynamics** block parameter is set to `Include valve opening dynamics`.

Extended Capabilities

C/C++ Code Generation

Generate C and C++ code using Simulink® Coder™.

See Also

[Pressure Compensator](#) | [Pressure Reducing 3-Way Valve](#) | [Pressure Relief Valve](#)

Topics

[“Upgrading Simscape Fluids Models Containing Hydraulics \(Isothermal\) Blocks”](#)

Introduced in R2016a

Pressure-Reducing Valve (IL)

Pressure-reducing valve in an isothermal system

Library: Simscape / Fluids / Isothermal Liquid / Valves & Orifices / Pressure Control Valves



Description

The Pressure-Reducing Valve (IL) block models a pressure-reducing valve in an isothermal liquid network. The valve remains open when the pressure at port **B** is less than a specified pressure. When the pressure at port **B** meets or surpasses this *set pressure*, the valve closes. The block functions based on the differential between the set pressure and the pressure at port **B**. For pressure control based on another element in the fluid system, see the Pressure Compensator Valve (IL) block.

Pressure Control

Two valve control options are available:

- When **Set pressure control** is set to **Controlled**, connect a pressure signal to port **Ps** and define the constant **Pressure regulation range**. The valve response will be triggered when P_B is greater than P_{set} , the **Set pressure (gauge)**, and below P_{max} , the sum of the set pressure and the user-defined **Pressure regulation range**. The pressure at port **B** acts as the control pressure, $P_{control}$, for this valve.
- When **Set pressure control** is set to **Constant**, the valve opening is continuously regulated between P_{set} and P_{max} by either a linear or tabular parameterization. When the **Tabulated data** option is selected, P_{set} and P_{max} are the first and last parameters of the **Pressure differential vector**, respectively.

Mass Flow Rate Equation

Momentum is conserved through the valve:

$$\dot{m}_A + \dot{m}_B = 0.$$

The mass flow rate through the valve is calculated as:

$$\dot{m} = \frac{C_d A_{valve} \sqrt{2\bar{p}}}{\sqrt{PR_{loss} \left(1 - \left(\frac{A_{valve}}{A_{port}} \right)^2 \right)}} \frac{\Delta p}{[\Delta p^2 + \Delta p_{crit}^2]^{1/4}},$$

where:

- C_d is the **Discharge coefficient**.
- A_{valve} is the instantaneous valve open area.
- A_{port} is the **Cross-sectional area at ports A and B**.

- $\bar{\rho}$ is the average fluid density.
- Δp is the valve pressure difference $p_A - p_B$.

The critical pressure difference, Δp_{crit} , is the pressure differential associated with the **Critical Reynolds number**, Re_{crit} , the flow regime transition point between laminar and turbulent flow:

$$\Delta p_{crit} = \frac{\pi \bar{\rho}}{8 A_{valve}} \left(\frac{\nu Re_{crit}}{C_d} \right)^2.$$

Pressure loss describes the reduction of pressure in the valve due to a decrease in area. PR_{loss} is calculated as:

$$PR_{loss} = \frac{\sqrt{1 - \left(\frac{A_{valve}}{A_{port}}\right)^2 (1 - C_d^2)} - C_d \frac{A_{valve}}{A_{port}}}{\sqrt{1 - \left(\frac{A_{valve}}{A_{port}}\right)^2 (1 - C_d^2)} + C_d \frac{A_{valve}}{A_{port}}}.$$

Pressure recovery describes the positive pressure change in the valve due to an increase in area. If you do not wish to capture this increase in pressure, set the **Pressure recovery** to Off. In this case, PR_{loss} is 1.

The opening area A_{valve} is determined by the closing parameterization (for Constant valves only) and the valve opening dynamics.

Closing Parameterization

Linear parameterization of the valve area is

$$A_{valve} = \hat{p} (A_{leak} - A_{max}) + A_{max},$$

where the normalized pressure, \hat{p} , is

$$\hat{p} = \frac{p_{control} - p_{set}}{p_{max} - p_{set}},$$

At the extremes of the valve pressure range, you can maintain numerical robustness in your simulation by adjusting the block **Smoothing factor**. With a nonzero smoothing factor, a smoothing function is applied to all calculated valve pressures, but primarily influences the simulation at the extremes of these ranges.

When the **Smoothing factor**, f , is nonzero, a smoothed, normalized pressure is instead applied to the valve area:

$$\hat{p}_{smoothed} = \frac{1}{2} + \frac{1}{2} \sqrt{\hat{p}^2 + \left(\frac{f}{4}\right)^2} - \frac{1}{2} \sqrt{(\hat{p} - 1)^2 + \left(\frac{f}{4}\right)^2}.$$

In the Tabulated data parameterization, A_{max} and A_{leak} are the first and last parameters of the **Opening area vector**, respectively. The smoothed, normalized pressure is also used when the smoothing factor is nonzero with linear interpolation and nearest extrapolation.

Opening Dynamics

If **Opening dynamics** are modeled, a lag is introduced to the flow response to valve opening. A_{valve} becomes the dynamic opening area, A_{dyn} ; otherwise, A_{valve} is the steady-state opening area. The

instantaneous change in dynamic opening area is calculated based on the **Opening time constant**, τ :

$$\dot{p}_{dyn} = \frac{p_{control} - p_{dyn}}{\tau}.$$

By default, **Opening dynamics** are turned Off.

Steady-state dynamics are set by the same parameterization as the valve opening, and are based on the control pressure, $p_{control}$. A nonzero **Smoothing factor** can provide additional numerical stability when the valve is in near-closed or near-open position.

Faulty Behavior

When faults are enabled, the valve open area becomes stuck at a specified value in response to one of these triggers:

- Simulation time — Faulting occurs at a specified time.
- Simulation behavior — Faulting occurs in response to an external trigger. This exposes port **Tr**.

Three fault options are available in the **Opening area when faulted** parameter:

- Closed — The valve freezes at its smallest value, depending on the **Opening parameterization**:
 - When **Opening parameterization** is set to Linear, the valve area freezes at the **Leakage area**.
 - When **Opening parameterization** is set to Tabulated data, the valve area freezes at the first element of the **Opening area vector**.
- Open — The valve freezes at its largest value, depending on the **Opening parameterization**:
 - When **Opening parameterization** is set to Linear, the valve area freezes at the **Maximum opening area**.
 - When **Orifice parameterization** is set to Tabulated data, the valve area freezes at the last element of the **Opening area vector**.
- Maintain last value — The valve area freezes at the valve open area when the trigger occurred.

Due to numerical smoothing at the extremes of the valve area, the minimum area applied is larger than the **Leakage area**, and the maximum is smaller than the **Maximum orifice area**, in proportion to the **Smoothing factor** value.

Once triggered, the valve remains at the faulted area for the rest of the simulation.

Ports

Conserving

A — Liquid port

isothermal liquid

Entry or exit point to the valve.

B — Liquid port

isothermal liquid

Entry or exit point to the valve.

Input

Ps — Set pressure signal

physical signal

Varying-signal pressure threshold for controlled valve operation.

Dependencies

To enable this port, set **Set pressure control** to `Controlled`.

Tr — External fault trigger

physical signal

Physical signal port for an external fault trigger. Triggering occurs when the value is greater than 0.5. There is no unit associated with the trigger value.

Dependencies

This port is visible when **Enable faults** is set to `On` and **Fault trigger** is set to `External`.

Parameters

Parameters

Set pressure control — Valve operation method

`Constant` (default) | `Controlled`

Valve operation method. A `Constant` valve closes linearly over a fixed pressure regulation range or in accordance with tabulated pressure and opening area data that you provide. A `Controlled` valve closes according to a variable set pressure signal at port **Pset** over a fixed pressure regulation range.

Opening parameterization — Method of modeling valve opening or closing

`Linear` (default) | `Tabular data`

Method of modeling the valve opening or closing. The valve opening is either parametrized linearly, which correlates the opening area to the provided pressure range, or by a table of values you provide that correlate the valve opening area to pressure differential data.

Dependencies

To enable this port, set **Set pressure control** to `Constant`.

Set pressure (gauge) — Gauge pressure beyond which valve operation is triggered

`0.1 MPa` (default) | positive scalar

Gauge pressure beyond which valve operation is triggered.

Dependencies

To enable this parameter, set **Set pressure control** to `Constant` and **Opening parameterization** to `Linear`.

Pressure regulation range — Valve operational pressure range

`0.1 MPa` (default) | positive scalar

Operational pressure range of the valve. The pressure regulation range begins at the **Set pressure (gauge)** and the end of the range is the maximum valve operating pressure.

Dependencies

To enable this parameter, set either:

- **Set pressure control** to Controlled
- **Set pressure control** to Constant and **Opening parameterization** to Linear

Maximum opening area — Area of a fully opened valve

1e-4 m² (default) | positive scalar

Cross-sectional area of the valve in its fully open position.

Dependencies

To enable this parameter, set either:

- **Set pressure control** to Controlled
- **Set pressure control** to Constant and **Opening parameterization** to Linear

Leakage area — Valve gap area when in fully closed position

1e-10 m² (default) | positive scalar

Sum of all gaps when the valve is in fully closed position. Any area smaller than this value is saturated to the specified leakage area. This contributes to numerical stability by maintaining continuity in the flow.

Dependencies

To enable this parameter, set either:

- **Set pressure control** to Controlled
- **Set pressure control** to Constant and **Opening parameterization** to Linear

Pressure differential vector — Vector of differential pressure values for tabular parameterization

[0.2 : 0.2 : 1.2] MPa (default) | 1-by-*n* vector

Vector of pressure differential values for the tabular parameterization of the valve opening area. The vector elements must correspond one-to-one with the elements in the **Opening area vector** parameter. The elements are listed in ascending order and must be greater than 0. Linear interpolation is employed between table data points.

Dependencies

To enable this parameter, set **Set pressure control** to Constant and **Opening parameterization** to Tabulated data.

Opening area vector — Valve opening areas for tabular parameterization

[1e-05, 8e-06, 6e-06, 4e-06, 2e-06, 1e-10] m² (default) | 1-by-*n* vector

Vector of valve opening areas for the tabular parameterization of the valve opening area. The vector elements must correspond one-to-one with the elements in the **Pressure differential vector**

parameter. The elements are listed in descending order and must be greater than 0. Linear interpolation is employed between table data points.

Dependencies

To enable this parameter, set **Set pressure control** to Constant and **Opening parameterization** to Tabulated data.

Cross-sectional area at ports A and B – Area at valve entry or exit

inf m² (default) | positive scalar

Cross-sectional area at the entry and exit ports **A** and **B**. These areas are used in the pressure-flow rate equation that determines the mass flow rate through the valve.

Discharge coefficient – Discharge coefficient

0.64 (default) | positive scalar

Correction factor accounting for discharge losses in theoretical flows. The default discharge coefficient for a valve in Simscape Fluids is 0.64.

Critical Reynolds number – Upper Reynolds number limit for laminar flow

150 (default) | positive scalar

Upper Reynolds number limit for laminar flow through the valve.

Smoothing factor – Numerical smoothing factor

0.01 (default) | positive scalar in the range [0,1]

Continuous smoothing factor that introduces a layer of gradual change to the flow response when the valve is in near-open or near-closed positions. Set this value to a nonzero value less than one to increase the stability of your simulation in these regimes.

Pressure recovery – Accounts for pressure increase in area expansions

Off (default) | On

Accounts for pressure increase when fluid flows from a region of smaller cross-sectional area to a region of larger cross-sectional area. This increase in pressure is not captured when **Pressure recovery** is set to Off.

Opening dynamics – Whether to account for flow response to valve opening

Off (default) | On

Accounts for transient effects to the fluid system due to valve opening. **Opening dynamics** set to On approximates opening conditions by introducing a first-order lag in the flow response. The **Opening time constant** also impacts the modeled opening dynamics.

Initial opening area – Open area at the start of the simulation

1e-10 m² (default) | positive scalar

Initial cross-sectional area of opening at the time of dynamic opening. This value is used to calculate the instantaneous opening area at the following time step.

Dependencies

To enable this parameter, set **Opening dynamics** to On.

Opening time constant – Valve opening time constant

0.1 s (default) | positive scalar

Constant that captures the time required for the fluid to reach steady-state when opening or closing the valve from one position to another. This parameter impacts the modeled opening dynamics.

Dependencies

To enable this parameter, set **Opening dynamics** to On.

Faults**Enable faults – Fault option**

Off (default) | On

Enable externally or temporally triggered faults. When faulting occurs, the valve area normally set by the opening parameterization will be set to the value specified in the **Opening area when faulted** parameter.

Opening area when faulted – Set faulted characteristics

Closed (default) | Open | Maintain last value

Sets the faulted valve type. You can choose for the valve to seize when the valve is opened, closed, or at the area when faulting is triggered.

Dependencies

To enable this parameter, set **Enable faults** to On.

Fault trigger – External or temporal trigger option

Temporal (default) | External

Whether a fault trigger occurs due to an external event or at a specified time.

When set to `External`, port **Tr** is enabled. A physical signal at port **Tr** that is greater than 0.5 triggers faulting.

When set to `Temporal`, when the **Simulation time for fault event** is reached, the valve area will be set to the value specified in the **Opening area when faulted** parameter.

Dependencies

To enable this parameter, set **Enable faults** to On.

Simulation time for fault event – Time at which faulting is triggered

5 s (default) | positive scalar

When the **Simulation time for fault event** is reached, the valve area is set to the value specified in the **Opening area when faulted** parameter.

Dependencies

To enable this parameter, set **Enable faults** to On and **Fault trigger** to `Temporal`.

See Also

Pressure Compensator Valve (IL) | Pressure-Reducing 3-Way Valve (IL) | Pressure-Compensated 3-Way Flow Control Valve (IL) | Pressure-Compensated Flow Control Valve (IL)

Introduced in R2020a

Pressure Reducing Valve (G)

Valve for restricting flow when at excessive pressure

Library: Simscape / Fluids / Gas / Valves & Orifices / Pressure Control
Valves



Description

The Pressure Reducing Valve (G) block models a valve that constricts so as to maintain a preset gauge pressure at its outlet (port **B**). The normally open valve begins to close when the outlet pressure, measured against atmospheric pressure, rises above the valve pressure setting. The opening area falls with the pressure drop down to a minimum—a point at which the valve is fully closed and only leakage flow remains.

The relationship between the opening area and the pressure drop depends on the parameterization of the valve. That relationship can take the form of a linear analytical expression or of a (generally nonlinear) tabulated function.

The flow can be laminar or turbulent, and it can reach (up to) sonic speeds. This happens at the vena contracta, a point just past the throat of the valve where the flow is both its narrowest and fastest. The flow then chokes and its velocity saturates, with a drop in downstream pressure no longer sufficing to increase its velocity. Choking occurs when the back-pressure ratio hits a critical value characteristic of the valve. Supersonic flow is not captured by the block.

Control and Other Pressures

The pressure at the outlet serves as the control signal of the valve. The greater its rise over the pressure setting of the same, the smaller its opening area becomes. For use in the block calculations, its value is defined as:

$$p_{\text{Ctl}} = p_{\text{B}},$$

where p is instantaneous pressure. The subscript **Ctl** denotes the control value and the subscript **B** that at the port. Both are determined during simulation as absolute pressures. The pressure setting of the valve is likewise computed as:

$$P_{\text{Set}} = P_{\text{B,Set}} + P_{\text{Atm}},$$

where P is a constant pressure parameter. The subscript **Set** denotes the valve setting, with the subscript **B, Set** being that specified in the block as a gauge pressure at the outlet (port **B**). The subscript **Atm** denotes the atmospheric value (specified in the Gas Properties (G) block of the model). For the maximum pressure of the valve:

$$P_{\text{Max}} = P_{\text{Set}} + \Delta P,$$

where ΔP refers specifically to the pressure regulation range of the valve, obtained as a constant from the block parameter of the same name. The subscript **Max** denotes the maximum value.

Control Pressure Overshoot

The degree to which the control pressure exceeds the pressure setting determines how much the valve will close. The pressure overshoot is expressed here as a fraction of the (width of the) pressure regulation range:

$$\hat{p} = \frac{p_{\text{Ctl}} - p_{\text{Set}}}{\Delta P}.$$

The fraction—technically, the overshoot, *normalized*—is 0 in the fully closed valve and 1 in the fully open valve. If the calculation should return a value outside of these bounds, the nearest of the two is used instead. (In other words, the fraction is *saturated* at 0 and 1.)

Numerical Smoothing

The normalized (and saturated) control pressure overshoot spans three regions. Below the pressure setting of the valve, its value is a constant zero. Above the maximum pressure—the sum of the pressure setting and the pressure regulation range—it is 1. In between, it varies, as a linear function of the control pressure measurement, p_{Ctl} .

The transitions between the regions are sharp and their slopes discontinuous. These pose a challenge to variable-step solvers (the sort commonly used with Simscape models). To precisely capture discontinuities, referred to in some contexts as *zero crossing events*, the solver must reduce its time step, pausing briefly at the time of the crossing in order to recompute its Jacobian matrix (a representation of the dependencies between the state variables of the model and their time derivatives).

This solver strategy is efficient and robust when discontinuities are present. It makes the solver less prone to convergence errors—but it can considerably extend the time needed to finish the simulation run, perhaps excessively so for practical use in real-time simulation. An alternative approach, used here, is to remove the discontinuities altogether.

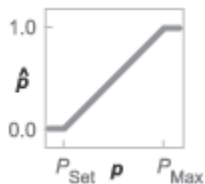

Normalized pressure overshoot with sharp transitions

The block removes the discontinuities by smoothing them over a specified time scale. The smoothing, which adds a slight distortion to the control pressure overshoot, ensures that the valve eases into its limiting positions rather than snap (abruptly) into them. The smoothing is optional: you can disable it by setting its time scale to zero. The shape and scale of the smoothing, when applied, derives in part from the cubic polynomials:

$$\lambda_L = 3\bar{p}_L^2 - 2\bar{p}_L^3$$

and

$$\lambda_R = 3\bar{p}_R^2 - 2\bar{p}_R^3,$$

where

$$\bar{p}_L = \frac{\hat{p}}{\Delta p^*}$$

and

$$\bar{p}_R = \frac{\hat{p} - (1 - \Delta p^*)}{\Delta p^*}.$$

In the equations:

- λ_L is the smoothing expression for the transition from the maximally closed position.
- λ_R is the smoothing expression for the transition from the fully open position.
- Δp^* is the (unitless) characteristic width of the pressure smoothing region:

$$\Delta p^* = f^* \frac{1}{2},$$

where f^* is a smoothing factor valued between 0 and 1 and obtained from the block parameter of the same name.

When the smoothing factor is 0, the control pressure overshoot stays in its original form—no smoothing applied—and its transitions remain abrupt. When it is 1, the smoothing spans the whole of the pressure regulation range (with the control pressure overshoot taking the shape of an S-curve).

At intermediate values, the smoothing is limited to a fraction of that range. A value of 0.5, for example, will smooth the transitions over a quarter of the pressure regulation range on each side (for a total smooth region of half the regulation range).

The smoothing adds two new regions to the control pressure overshoot—one for the smooth transition on the left, another for that on the right, giving a total of five regions. These are expressed in the piecewise function:

$$\hat{p}^* = \begin{cases} 0, & \hat{p} \leq 0 \\ \hat{p} \lambda_L, & \hat{p} < \Delta p^* \\ \hat{p}, & \hat{p} \leq 1 - \Delta p^*, \\ \hat{p}(1 - \lambda_R) + \lambda_R, & \hat{p} < 1 \\ 1 & \hat{p} \geq 1 \end{cases}$$

where the asterisk indicates a smoothed variable. The figure shows the effect of smoothing on the sharpness of the transitions.

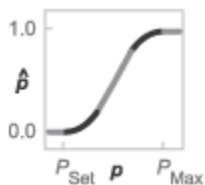

Sonic Conductance

As the normalized control pressure varies during simulation, so does the mass flow rate through the valve. The relationship between the two variables, however, is indirect. The mass flow rate is defined

in terms of the valve's sonic conductance and it is this quantity that the normalized inlet pressure determines.

Sonic conductance, if you are unfamiliar with it, describes the ease with which a gas will flow when it is choked—when its velocity is at its theoretical maximum (the local speed of sound). Its measurement and calculation are covered in detail in the ISO 6358 standard (on which this block is based).

Only one value is commonly reported in valve data sheets: one taken at steady state in the fully open position. This is the same specified in the **Sonic conductance at maximum flow** parameter when the **Valve parameterization** setting is **Sonic conductance**. For values across the opening range of the valve, this maximum is scaled by the normalized pressure overshoot:

$$C = (C_{\text{Max}} - C_{\text{Min}})\hat{p} + C_{\text{Min}}$$

where C is sonic conductance and the subscripts **Max** and **Min** denote its values in the fully open and fully closed valve.

Other Parameterizations

Because sonic conductance may not be available (or the most convenient choice for your model), the block provides several equivalent parameterizations. Use the **Valve parameterization** drop-down list to select the best for the data at hand. The parameterizations are:

- Restriction area
- Sonic conductance
- Cv coefficient (USCS)
- Kv coefficient (SI)

The parameterizations differ only in the data that they require of you. Their mass flow rate calculations are still based on sonic conductance. If you select a parameterization other than **Sonic conductance**, then the block converts the alternate data—the (computed) opening area or a (specified) flow coefficient—into an equivalent sonic conductance.

Flow Coefficients

The flow coefficients measure what is, at bottom, the same quantity—the flow rate through the valve at some agreed-upon temperature and pressure differential. They differ only in the standard conditions used in their definition and in the physical units used in their expression:

- C_v is measured at a generally accepted temperature of 60 °F and pressure drop of 1 PSI; it is expressed in imperial units of US gpm. This is the flow coefficient used in the model when the **Valve parameterization** block parameter is set to **Cv coefficient (USCS)**.
- K_v is measured at a generally accepted temperature of 15 °C and pressure drop of 1 bar; it is expressed in metric units of m³/h. This is the flow coefficient used in the model when the **Valve parameterization** block parameter is set to **Kv coefficient (SI)**.

Sonic Conductance Conversions

If the valve parameterization is set to **Cv Coefficient (USCS)**, the sonic conductance is computed at the maximally closed and fully open valve positions from the **Cv coefficient (SI) at maximum flow** and **Cv coefficient (SI) at leakage flow** block parameters:

$$C = (4 \times 10^{-8} C_v) m^3 / (sPa),$$

where C_v is the flow coefficient value at maximum or leakage flow. The subsonic index, m , is set to 0.5 and the critical pressure ratio, b_{cr} , is set to 0.3. (These are used in the mass flow rate calculations given in the Momentum Balance section.)

If the **Kv coefficient (SI)** parameterization is used instead, the sonic conductance is computed at the same valve positions (maximally closed and fully open) from the **Kv coefficient (USCS) at maximum flow** and **Kv coefficient (USCS) at leakage flow** block parameters:

$$C = (4.758 \times 10^{-8} K_v) m^3 / (sPa),$$

where K_v is the flow coefficient value at maximum or leakage flow. The subsonic index, m , is set to 0.5 and the critical pressure ratio, b_{cr} , is set to 0.3.

For the **Restriction area** parameterization, the sonic conductance is computed (at the same valve positions) from the **Maximum opening area**, and **Leakage area** block parameters:

$$C = (0.128 \times 4S/\pi)L / (sbar),$$

where S is the opening area at maximum or leakage flow. The subsonic index, m , is set to 0.5 while the critical pressure ratio, b_{cr} is computed from the expression:

$$0.41 + 0.272 \left[\frac{\hat{p}(S_{Max} - S_{Leak}) + S_{Leak}}{S} \right]^{0.25}.$$

Momentum Balance

The causes of those pressure losses incurred in the passages of the valve are ignored in the block. Whatever their natures—sudden area changes, flow passage contortions—only their cumulative effect is considered during simulation. This effect is assumed to reflect entirely in the sonic conductance of the valve (or in the data of the alternate valve parameterizations).

Mass Flow Rate

When the flow is choked, the mass flow rate is a function of the sonic conductance of the valve and of the thermodynamic conditions (pressure and temperature) established at the inlet. The function is linear with respect to pressure:

$$\dot{m}_{ch} = C \rho_0 p_{in} \sqrt{\frac{T_0}{T_{in}}},$$

where:

- C is the sonic conductance inside the valve. Its value is obtained from the block parameter of the same name or by conversion of other block parameters (the exact source depending on the **Valve parameterization** setting).
- ρ is the gas density, here at standard conditions (subscript 0), obtained from the **Reference density** block parameter.
- p is the absolute gas pressure, here corresponding to the inlet (in).
- T is the gas temperature at the inlet (in) or at standard conditions (0), the latter obtained from the **Reference temperature** block parameter.

When the flow is subsonic, and therefore no longer choked, the mass flow rate becomes a nonlinear function of pressure—both that at the inlet as well as the reduced value at the outlet. In the turbulent

flow regime (with the outlet pressure contained in the back-pressure ratio of the valve), the mass flow rate expression is:

$$\dot{m}_{\text{tur}} = C\rho_0 p_{\text{in}} \sqrt{\frac{T_0}{T_{\text{in}}}} \left[1 - \left(\frac{p_r - b_{\text{cr}}}{1 - b_{\text{cr}}} \right)^2 \right]^m,$$

where:

- p_r is the back-pressure ratio, or that between the outlet pressure (p_{out}) and the inlet pressure (p_{in}):

$$P_r = \frac{p_{\text{out}}}{p_{\text{in}}}$$

- b_{cr} is the critical pressure ratio at which the flow becomes choked. Its value is obtained from the block parameter of the same name or by conversion of other block parameters (the exact source depending on the **Valve parameterization** setting).
- m is the *subsonic index*, an empirical coefficient used to more accurately characterize the behavior of subsonic flows. Its value is obtained from the block parameter of the same name or by conversion of other block parameters (the exact source depending on the **Valve parameterization** setting).

When the flow is laminar (and still subsonic), the mass flow rate expression changes to:

$$\dot{m}_{\text{lam}} = C\rho_0 p_{\text{in}} \left[\frac{1 - p_r}{1 - b_{\text{lam}}} \right] \sqrt{\frac{T_0}{T_{\text{in}}}} \left[1 - \left(\frac{b_{\text{lam}} - b_{\text{cr}}}{1 - b_{\text{cr}}} \right)^2 \right]^m$$

where b_{lam} is the critical pressure ratio at which the flow transitions between laminar and turbulent regimes (obtained from the **Laminar flow pressure ratio** block parameter). Combining the mass flow rate expressions into a single (piecewise) function, gives:

$$\dot{m} = \begin{cases} \dot{m}_{\text{lam}}, & b_{\text{lam}} \leq p_r < 1 \\ \dot{m}_{\text{tur}}, & b_{\text{cr}} \leq p_r < b_{\text{lam}}, \\ \dot{m}_{\text{ch}}, & p_r < b_{\text{cr}} \end{cases}$$

with the top row corresponding to subsonic and laminar flow, the middle row to subsonic and turbulent flow, and the bottom row to choked (and therefore sonic) flow.

Mass Balance

The volume of fluid inside the valve, and therefore the mass of the same, is assumed to be very small and it is, for modeling purposes, ignored. As a result, no amount of gas can accumulate there. By the principle of conservation of mass, the mass flow rate into the valve through one port must therefore equal that out of the valve through the other port:

$$\dot{m}_A + \dot{m}_B = 0,$$

where \dot{m} is defined as the mass flow rate *into* the valve through port **A** or **B**. Note that in this block the flow can reach but not exceed sonic speeds.

Energy Balance

The valve is modeled as an adiabatic component. No heat exchange can occur between the gas and the wall that surrounds it. No work is done on or by the gas as it traverses from inlet to outlet. With

these assumptions, energy can flow by advection only, through ports **A** and **B**. By the principle of conservation of energy, the sum of the port energy flows must then always equal zero:

$$\phi_A + \phi_B = 0,$$

where ϕ is defined as the energy flow rate *into* the valve through one of the ports (**A** or **B**).

Ports

Conserving

A — Valve entrance

gas

Opening through which the working fluid must enter the valve.

B — Valve entrance

gas

Opening through which the working fluid must exit the valve.

Parameters

Valve parameterization — Method by which to characterize the opening of the valve

Sonic conductance (default) | Cv coefficient (USCS) | Kv coefficient (SI) |
Restriction area

Choice of ISO method to use in the calculation of mass flow rate. All calculations are based on the **Sonic conductance** parameterization; if a different option is selected, the data specified in converted into equivalent sonic conductance, critical pressure ratio, and subsonic index. See the block description for more information on the conversion.

This parameter determines which measures of valve opening you must specify—and therefore which of those measures appear as parameters in the block dialog box.

Opening parameterization — Method by which to calculate the opening characteristics of the valve

Linear (default) | Tabulated data

Method by which to calculate the opening area of the valve. The default setting treats the opening area as a linear function of the orifice opening fraction. The alternative setting allows for a general, nonlinear relationship to be specified (in tabulated form).

Set pressure (gauge) — Inlet gauge pressure required to open the valve

0.1 MPa (default) | scalar in units of pressure

Inlet gauge pressure required to open the valve. This parameter marks the beginning of the pressure regulation range, over which the valve progressively opens in an effort to contain a pressure rise. The opening area of the valve depends on the difference between the actual inlet pressure to the valve specified here.

Dependencies

This parameter is active and exposed in the block dialog box when the **Opening parameterization** setting is **Linear**.

Pressure regulation range — Width of the pressure range over which the opening area is variable

0.1 MPa (default) | scalar in units of pressure

Width of the pressure range over which the opening area of the valve is variable. The pressure range begins at the set pressure (specified in the block parameter of the same name). It ends at the sum of the set pressure with the value specified here. The smaller the pressure regulation range, the greater the impact of a unit pressure rise on the opening area of the valve.

Dependencies

This parameter is active and exposed in the block dialog box when the **Opening parameterization** setting is Linear.

Sonic conductance at maximum flow — Measure of maximum flow rate at reference upstream conditions

1.6 l/s/bar (default) | positive scalar in units of volume/time/pressure

Equivalent measure of the maximum flow rate allowed through the valve at some reference inlet conditions, generally those outlined in ISO 8778. The flow is at a maximum when the valve is fully open and the flow velocity is choked (it being saturated at the local speed of sound). This is the value generally reported by manufacturers in technical data sheets.

Sonic conductance is defined as the ratio of the mass flow rate through the valve to the product of the pressure and density upstream of the valve inlet. This parameter is often referred to in the literature as the *C-value*.

Dependencies

This parameter is active and exposed in the block dialog box when the **Valve parameterization** setting is Sonic conductance.

Sonic conductance at leakage flow — Measure of minimum flow rate at reference upstream conditions

1e-5 l/s/bar (default) | positive scalar in units of volume/time/pressure

Equivalent measure of the minimum flow rate allowed through the valve at some reference inlet conditions, generally those outlined in ISO 8778. The flow is at a minimum when the valve is maximally closed and only a small leakage area—due to sealing imperfections, say, or natural valve tolerances—remains between its ports.

Sonic conductance is defined as the ratio of the mass flow rate through the valve to the product of the pressure and density upstream of the valve inlet. This parameter is often referred to in the literature as the *C-value*.

This parameter serves primarily to ensure that closure of the valve does not cause portions of the gas network to become isolated (a condition known to cause problems in simulation). The exact value specified here is less important than its being a (very small) number greater than zero.

Dependencies

This parameter is active and exposed in the block dialog box when the **Valve parameterization** setting is Sonic conductance.

Critical pressure ratio — Back-pressure ratio, at reference upstream conditions, at which the flow rate is a maximum

0.3 (default) | positive unitless scalar

Ratio of downstream to upstream absolute pressures at which the flow becomes choked (and its velocity becomes saturated at the local speed of sound). This parameter is often referred to in the literature as the *b-value*. Enter a number greater than or equal to zero and smaller than the **Laminar flow pressure ratio** block parameter.

Dependencies

This parameter is active and exposed in the block dialog box when the **Valve parameterization** setting is `Sonic conductance`.

Subsonic index — Exponent used to more accurately characterize flow in the subsonic regime

0.5 (default) | positive unitless scalar

Empirical exponent used to more accurately calculate the mass flow rate through the valve when the flow is subsonic. This parameter is sometimes referred to as the *m-index*. Its value is approximately 0.5 for valves (and other components) whose flow paths are fixed.

Dependencies

This parameter is active and exposed in the block dialog box when the **Valve parameterization** setting is `Sonic conductance`.

Cv coefficient (USCS) at maximum flow — Flow coefficient of the fully open valve expressed in US customary units0.4 (default) | positive scalar in units of ft³/min

Flow coefficient of the fully open valve, expressed in the US customary units of ft³/min (as described in NFPA T3.21.3). This parameter measures the relative ease with which the gas will traverse the valve when driven by a given pressure differential. This is the value generally reported by manufacturers in technical data sheets.

Dependencies

This parameter is active and exposed in the block dialog box when the **Valve parameterization** setting is `Cv coefficient (USCS)`.

Cv coefficient (USCS) at leakage flow — Flow coefficient of the maximally closed valve expressed in US customary units1e-6 (default) | positive scalar in units of ft³/min

Flow coefficient of the maximally closed valve, expressed in the US customary units of ft³/min (as described in NFPA T3.21.3). This parameter measures the relative ease with which the gas will traverse the valve when driven by a given pressure differential.

The purpose of this parameter is primarily to ensure that closure of the valve does not cause portions of the gas network to become isolated (a condition known to cause problems in simulation). The exact value specified here is less important than its being a (very small) number greater than zero.

Dependencies

This parameter is active and exposed in the block dialog box when the **Valve parameterization** setting is `Cv coefficient (USCS)`.

Kv coefficient (SI) at maximum flow — Flow coefficient of the fully open valve expressed in SI units0.3 (default) | positive scalar in units of m^3/hr

Flow coefficient of the fully open valve, expressed in the SI units of m^3/hr . This parameter measures the relative ease with which the gas will traverse the valve when driven by a given pressure differential. This is the value generally reported by manufacturers in technical data sheets.

Dependencies

This parameter is active and exposed in the block dialog box when the **Valve parameterization** setting is **Kv coefficient (SI)**.

Kv coefficient (SI) at leakage flow — Flow coefficient of the maximally closed valve expressed in SI units1e-6 (default) | positive scalar in units of m^3/hr

Flow coefficient of the maximally closed valve, expressed in the SI units of m^3/hr . This parameter measures the relative ease with which the gas will traverse the valve when driven by a given pressure differential.

The purpose of this parameter is primarily to ensure that closure of the valve does not cause portions of the gas network to become isolated (a condition known to cause problems in simulation). The exact value specified here is less important than its being a (very small) number greater than zero.

Dependencies

This parameter is active and exposed in the block dialog box when the **Valve parameterization** setting is **Kv coefficient (SI)**.

Maximum opening area — Opening area in the fully open position due to sealing imperfections1e-4 m^2 (default) | positive scalar in units of area

Opening area of the valve in the fully open position, when the valve is at the upper limit of the pressure regulation range. The block uses this parameter to scale the chosen measure of valve opening—sonic conductance, say, or C_v flow coefficient—throughout the pressure regulation range.

Dependencies

This parameter is active and exposed in the block dialog box when the **Valve parameterization** setting is **Restriction area**.

Leakage area — Opening area in the maximally closed position due to sealing imperfections1e-12 m^2 (default) | positive scalar in units of area

Opening area of the valve in the maximally closed position, when only internal leakage between the ports remains. This parameter serves primarily to ensure that closure of the valve does not cause portions of the gas network to become isolated (a condition known to cause problems in simulation). The exact value specified here is less important than its being a (very small) number greater than zero.

Dependencies

This parameter is active and exposed in the block dialog box when the **Valve parameterization** setting is **Restriction area**.

Control pressure (gauge) vector — Vector of control pressures at which to specify valve opening data

[0.2:0.2:1.2] MPa (default) | vector in units of pressure

Vector of control pressures at which to specify the chosen measure of valve opening—sonic conductance, flow coefficient (in SI or USCS forms), or opening area. This vector must be equal in size to that (or those) containing the valve opening data. The vector elements must be positive and increase monotonically in value from left to right.

The first vector element gives the pressure setting of the valve (at which the valve begins to close). This element is equivalent to the **Set pressure** parameter of the **Linear** opening parameterizations. The last element gives the maximum pressure, at which the valve is maximally closed and only leakage flow remains. The difference between the two gives the pressure regulation range of the valve.

Dependencies

This parameter is active and exposed in the block dialog box when the **Opening parameterization** setting is **Tabulated data**.

Sonic conductance vector — Vector of sonic conductances at given control pressures

[1e-05, .32, .64, .96, 1.28, 1.6] l/s/bar (default) | vector with units of volume/time/pressure

Vector of sonic conductances at the given valve control pressures. The sonic conductances each correspond to an element in the **Control pressure (gauge) vector** parameter, with the latter serving (in a Cartesian plot) as the abscissa and the former as the ordinate. The two vectors—of sonic conductances and control pressures—must be the same in size.

Sonic conductance measures the flow rate through the fully open valve at the onset of choking (when the flow reaches its maximum velocity, the local speed of sound). Measurements are carried out at some reference inlet conditions (generally those outlined in ISO 8778). Here, those conditions include the pressures given (as interpolation breakpoints) in the control pressure vector.

Dependencies

This parameter is active and exposed in the block dialog box when the **Valve parameterization** setting is **Sonic conductance** and the **Opening parameterization** setting is **Tabulated data**.

Critical pressure ratio vector — Vector of critical pressure ratios at given control pressures

0.3 * ones(1, 6) (default) | unitless vector

Vector of critical pressure ratios at the given valve control pressures. The ratios each correspond to an element in the **Control pressure (gauge) vector** parameter, with the latter serving (in a Cartesian plot) as the abscissa and the former as the ordinate. The two vectors—of critical pressure ratios and control pressures—must be the same in size.

The critical pressure ratio is the fraction of downstream over upstream absolute pressures at which the flow becomes choked (and its velocity becomes saturated at the local speed of sound). Measurements are carried out at some reference inlet conditions (generally those outlined in ISO 8778). Here, those conditions include the pressures given (as interpolation breakpoints) in the control pressure vector.

The values specified here must each be greater than or equal to zero and smaller than the **Laminar flow pressure ratio** block parameter.

Dependencies

This parameter is active and exposed in the block dialog box when the **Valve parameterization** setting is **Sonic conductance** and the **Opening parameterization** setting is **Tabulated data**.

Cv coefficient (USCS) vector – Vector of flow coefficients, in USCS units, at given control pressures

[1e-06, .08, .16, .24, .32, .4] (default) | vector in units of ft³/min

Vector of flow coefficients, expressed in US customary units of ft³/min (as described in NFPA T3.21.3), at the given valve control pressures. The flow coefficients each correspond to an element in the **Control pressure (gauge) vector** parameter, with the latter serving (in a Cartesian plot) as the abscissa and the former as the ordinate. The two vectors—of flow coefficients and control pressures—must be the same in size.

The flow coefficient measures the relative ease with which the flow, when subjected to some reference pressure condition, can traverse the valve. Its value is commonly reported in technical data sheets for the fully open valve (alongside the pressure condition to which the measurement corresponds). The vector elements specified here each correspond to a different measurement.

Dependencies

This parameter is active and exposed in the block dialog box when the **Valve parameterization** setting is **Cv coefficient (USCS)** and the **Opening parameterization** setting is **Tabulated data**.

Kv coefficient (SI) vector – Vector of flow coefficients, in SI units, at given control pressures

[1e-06, .06, .12, .18, .24, .3] (default) | vector in units of m³/hr

Vector of flow coefficients, expressed in SI units of m³/hr (as described in NFPA T3.21.3), at the given valve control pressures. The flow coefficients each correspond to an element in the **Control pressure (gauge) vector** parameter, with the latter serving (in a Cartesian plot) as the abscissa and the former as the ordinate. The two vectors—of flow coefficients and control pressures—must be the same in size.

The flow coefficient measures the relative ease with which the flow, when subjected to some reference pressure condition, can traverse the valve. Its value is commonly reported in technical data sheets for the fully open valve (alongside the pressure condition to which the measurement corresponds). The vector elements specified here each correspond to a different measurement.

Dependencies

This parameter is active and exposed in the block dialog box when the **Valve parameterization** setting is **Kv coefficient (SI)** and the **Opening parameterization** setting is **Tabulated data**.

Opening area vector – Vector of opening areas at given control pressures

[1e-10, 2e-06, 4e-06, 6e-06, 8e-06, 1e-05] m² (default) | vector in units of area

Vector of valve opening areas at the given control pressure breakpoints. The opening areas each correspond to an element in the **Control pressure (gauge) vector** parameter, with the latter serving (in a Cartesian plot) as the abscissa and the former as the ordinate. The two vectors—of opening areas and control pressures—must be the same in size.

The opening area is that normal to the direction of flow at the point of narrowest aperture (the location of the valve control member).

Dependencies

This parameter is active and exposed in the block dialog box when the **Valve parameterization** setting is **Restriction area** and the **Opening parameterization** setting is **Tabulated data**.

Cross-sectional area at ports A, B, and T — Area normal to the flow path at the valve ports

0.01 m² (default) | positive scalar in units of area

Area normal to the flow path at the valve ports. The ports are assumed to be of the same size. The flow area specified here should (ideally) match those of the inlets of adjoining components.

Smoothing factor — Amount of smoothing to apply to the valve opening function

0 (default) | positive unitless scalar

Amount of smoothing to apply to the opening function of the valve. This parameter determines the widths of the regions to be smoothed—one located at the fully open position, the other at the fully closed position.

The smoothing superposes on each region of the opening function a nonlinear segment (a third-order polynomial function, from which the smoothing arises). The greater the value specified here, the greater the smoothing is, and the broader the nonlinear segments become.

At the default value of 0, no smoothing is applied. The transitions to the maximally closed and fully open positions then introduce discontinuities (associated with zero-crossings). These can slow down the rate of simulation.

Laminar flow pressure ratio — Pressure ratio at which the flow transitions between laminar and turbulent regimes

0.999 (default) | positive unitless scalar

Pressure ratio at which the flow transitions between laminar and turbulent flow regimes. The pressure ratio is the fraction of the absolute pressure downstream of the valve over that just upstream of it. The flow is laminar when the actual pressure ratio is above the threshold specified here and turbulent when it is below. Typical values range from 0.995 to 0.999.

Reference temperature — ISO 8778 reference temperature

293.15 K (default) | scalar in units of temperature

Temperature at standard reference atmosphere, defined as 293.15 K in ISO 8778.

Reference density — ISO 8778 reference density

1.185 (default) | positive scalar in units of mass/volume

Density at standard reference atmosphere, defined as 1.185 kg/m³ in ISO 8778.

Extended Capabilities

C/C++ Code Generation

Generate C and C++ code using Simulink® Coder™.

See Also

Variable Orifice ISO 6358 (G) | Pressure Relief Valve (G)

Introduced in R2018b

Pressure Reducing Valve (TL)

Pressure control valve for maintaining reduced pressure in fluid network portion

Library: Simscape / Fluids / Thermal Liquid / Valves & Orifices / Pressure Control Valves



Description

The Pressure Reducing Valve (TL) block represents a valve for maintaining a reduced pressure in portion of a fluid network. The valve stays fully open when the pressure at port B is lower than the valve set pressure. At the set pressure, the valve control member moves to reduce the flow rate through the valve. The valve opening area continues to decrease with increasing pressure until only leakage flow remains.

A smoothing function allows the valve opening area to change smoothly between the fully closed and fully open positions. The smoothing function does this by removing the abrupt opening area changes at the zero and maximum ball positions. The figure shows the effect of smoothing on the valve opening area curve.

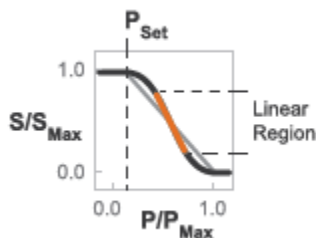

Opening-Area Curve Smoothing

Mass Balance

The mass conservation equation in the valve is

$$\dot{m}_A + \dot{m}_B = 0,$$

where:

- \dot{m}_A is the mass flow rate into the valve through port A.
- \dot{m}_B is the mass flow rate into the valve through port B.

Momentum Balance

The momentum conservation equation in the valve is

$$p_A - p_B = \frac{\dot{m} \sqrt{\dot{m}^2 + \dot{m}_{cr}^2}}{2\rho_{Avg} C_d^2 S^2} \left[1 - \left(\frac{S_R}{S} \right)^2 \right] P_{R_{Loss}},$$

where:

- p_A and p_B are the pressures at port A and port B.
- \dot{m} is the mass flow rate.
- \dot{m}_{cr} is the critical mass flow rate.
- ρ_{Avg} is the average liquid density.
- C_d is the discharge coefficient.
- S_R is the valve opening area.
- S is the valve inlet area.
- PR_{Loss} is the pressure ratio:

$$PR_{Loss} = \frac{\sqrt{1 - (S_R/S)^2(1 - C_d^2)} - C_d(S_R/S)}{\sqrt{1 - (S_R/S)^2(1 - C_d^2)} + C_d(S_R/S)}$$

The valve opening area is computed as

$$S_R = \begin{cases} S_{Max}, & p_{control} \leq p_{set} \\ S_{Max}(1 - \lambda_L) + S_{Linear}\lambda_L, & p_{control} < p_{Min} + \Delta p_{smooth} \\ S_{Linear}, & p_{control} \leq p_{Max} - \Delta p_{smooth}, \\ S_{Linear}(1 - \lambda_R) + S_{Leak}\lambda_R, & p_{control} < p_{Max} \\ S_{Leak}, & p_{control} \geq p_{Max} \end{cases}$$

where:

- S_{Leak} is the valve leakage area.
- S_{Linear} is the linear valve opening area:

$$S_{Linear} = \left(\frac{S_{Leak} - S_{Max}}{p_{Max} - p_{set}} \right) (p_{control} - p_{set}) + S_{Max}$$

- S_{Max} is the maximum valve opening area.
- $p_{control}$ is the valve control pressure:

$$p_{control} = p_B$$

- p_{set} is the valve set pressure:

$$p_{set} = p_{set, gauge} + p_{Atm}$$

- p_{Min} is the minimum pressure.
- p_{Max} is the maximum pressure:

$$p_{max} = p_{set, gauge} + p_{range} + p_{Atm}$$

- Δp is the portion of the pressure range to smooth.
- λ_L and λ_R are the cubic polynomial smoothing functions

$$\lambda_L = 3\bar{p}_L^2 - 2\bar{p}_L^3$$

and

$$\lambda_R = 3\bar{p}_R^2 - 2\bar{p}_R^3$$

where:

$$\bar{p}_L = \frac{p_{control} - p_{set}}{(p_{set} + \Delta p_{smooth}) - p_{set}}$$

and

$$\bar{p}_R = \frac{p_B - (p_{max} - \Delta p_{smooth})}{p_{max} - (p_{max} - \Delta p_{smooth})}$$

The critical mass flow rate is

$$\dot{m}_{cr} = Re_{cr} \mu_{Avg} \sqrt{\frac{\pi}{4}} S_R.$$

Energy Balance

The energy conservation equation in the valve is

$$\phi_A + \phi_B = 0,$$

where:

- ϕ_A is the energy flow rate into the valve through port A.
- ϕ_B is the energy flow rate into the valve through port B.

Ports

- A — Thermal liquid conserving port representing valve inlet A
- B — Thermal liquid conserving port representing valve inlet B

Parameters

Parameters Tab

Valve set pressure (gauge)

Minimum gauge pressure at port B required to actuate the valve. A pressure rise above the set pressure causes the valve to gradually close until only leakage flow remains. The default value is 0.1 MPa.

Pressure regulation range

Difference between the maximum and set pressures at port B. The valve begins to close at the set pressure. It is fully closed at the maximum pressure. The default value is 0.01 MPa.

Maximum opening area

Flow cross-sectional area in the fully open state. This state corresponds to pressures lower than the set pressure. The default value is 1e-4 MPa.

Leakage area

Aggregate area of all fluid leaks in the valve. The leakage area helps to prevent numerical issues due to isolated fluid network sections. For numerical robustness, set this parameter to a nonzero value. The default value is $1e-12$.

Smoothing factor

Fraction of the opening-area curve, expressed as a fraction from 0 to 1, to smooth. The block replaces the discontinuities in the opening area curve with smooth transitions that span the specified fraction of the curve. The default value is 0.01 .

A smoothing factor of 0 corresponds to a linear function that is discontinuous at the set and maximum-area pressures. A smoothing factor of 1 corresponds to a nonlinear function that changes continuously throughout the entire function domain.

A smoothing factor between 0 and 1 corresponds to a continuous piece-wise function with smooth nonlinear transitions at the set and maximum-area pressures and linear segments elsewhere.

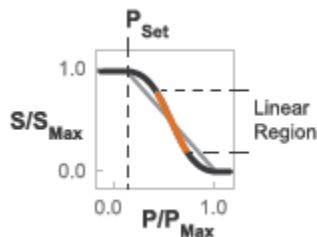
**Opening-Area Curve Smoothing****Cross-sectional area at ports A and B**

Flow area at the valve inlets. The inlets are assumed equal in size. The default value is 0.01 m^2 .

Characteristic longitudinal length

Approximate length of the valve. This parameter provides a measure of the longitudinal scale of the valve. The default value is 0.1 m .

Discharge coefficient

Semi-empirical parameter commonly used as a measure of valve performance. The discharge coefficient is defined as the ratio of the actual mass flow rate through the valve to its theoretical value.

The block uses this parameter to account for the effects of valve geometry on mass flow rates. Textbooks and valve data sheets are common sources of discharge coefficient values. By definition, all values must be greater than 0 and smaller than 1. The default value is 0.7 .

Critical Reynolds number

Reynolds number corresponding to the transition between laminar and turbulent flow regimes. The flow through the valve is assumed laminar below this value and turbulent above it. The appropriate values to use depend on the specific valve geometry. The default value is 12.

Variables Tab**Mass flow rate into port A**

Mass flow rate into the component through port **A** at the start of simulation. The default value is 1 kg/s.

Extended Capabilities**C/C++ Code Generation**

Generate C and C++ code using Simulink® Coder™.

See Also

Pressure Relief Valve (TL)

Introduced in R2016a

Pressure-Reducing Valve (2P)

Pressure-reducing valve in a two-phase fluid network

Library: Simscape / Fluids / Two-Phase Fluid / Valves & Orifices / Pressure Control Valves



Description

The Pressure-Reducing Valve (2P) block models a pressure-controlling reducing valve in a two-phase fluid network. The valve is open when the pressure at port **B** is less than the set pressure, and closes when the pressure exceeds that value. The control pressure can be set as a constant in the **Set pressure (gauge)** parameter or, when you set **Set pressure control** to **Controlled**, the set pressure can vary according to the input signal at port **Ps**.

Fluid properties inside the valve are calculated from inlet conditions. There is no heat exchange between the fluid and the environment, and therefore phase change inside the valve only occurs due to a pressure drop or a propagated phase change from another part of the model.

A number of block parameters are based on nominal operating conditions, which correspond to the valve rated performance, such as a specification on a manufacturer datasheet.

Pressure Control

The valve closes when the pressure in the valve, $p_{control}$, exceeds the set pressure, p_{set} . The valve is fully closed when the control pressure reaches the end of the **Pressure regulation range**, p_{range} .

When you set **Set pressure control** to **Constant**, the opening fraction of the valve, λ , is expressed as:

$$\lambda = 1 - (1 - f_{leak}) \frac{(p_{control} - p_{set})}{p_{range}},$$

where:

- f_{leak} is the **Closed valve leakage as a fraction of nominal flow**.
- $p_{control}$ is the control pressure, which is the difference between the pressure at port **B** and atmospheric pressure.
- p_{set} is the **Set pressure (gauge)**.

When you set **Set pressure control** to **Controlled**, the valve opening fraction is:

$$\lambda = 1 - (1 - f_{leak}) \frac{(p_{control} - p_s)}{p_{range}},$$

where p_s is the signal at port **Ps**. If the control pressure exceeds the valve pressure range, the valve opening fraction is 0.

Mass Flow Rate

The mass flow rate depends on the pressure differential, and therefore the open area of the valve. It is calculated as:

$$\dot{m}_A = \lambda \dot{m}_{nom} \left[\sqrt{\frac{v_{nom}}{2\Delta p_{nom}}} \right] \sqrt{\frac{2}{v_{in} (\Delta p^2 + \Delta p_{lam}^2)^{0.25}}},$$

where:

- Δp is the pressure drop over the valve, $p_A - p_B$.
- Δp_{lam} is the pressure transition threshold between laminar and turbulent flow, which is calculated from the **Laminar flow pressure ratio**, B_{lam} :

$$\Delta p_{lam} = \frac{(p_A + p_B)}{2} (1 - B_{lam}).$$

- \dot{m}_{nom} is the **Nominal mass flow rate at maximum opening**.
- Δp_{nom} is the **Nominal pressure drop rate at maximum opening**.
- v_{nom} is the nominal inlet specific volume. This value is determined from the fluid properties tabulated data based on the **Nominal inlet specific enthalpy** and **Nominal inlet pressure** parameters.
- v_{in} is the inlet specific volume.

Fluid Specific Volume Dynamics

When the fluid at the valve inlet is a liquid-vapor mixture, the block calculates the specific volume as:

$$v_{in} = (1 - x_{dyn})v_{liq} + x_{dyn}v_{vap},$$

where:

- x_{dyn} is the inlet vapor quality. The block applies a first-order lag to the inlet vapor quality of the mixture.
- v_{liq} is the liquid specific volume of the fluid.
- v_{vap} is the vapor specific volume of the fluid.

If the inlet fluid is liquid or vapor, v_{in} is the respective liquid or vapor specific volume.

Vapor quality lag

If the inlet vapor quality is a liquid-vapor mixture, a first-order time lag is applied:

$$\frac{dx_{dyn}}{dt} = \frac{x_{in} - x_{dyn}}{\tau},$$

where:

- x_{dyn} is the dynamic fluid vapor quality.
- x_{in} is the current inlet vapor quality.
- τ is the **Inlet phase change time constant**.

If the inlet fluid is a subcooled liquid or superheated vapor, x_{dyn} is equal to x_{in} .

Mass Balance

Mass is conserved in the valve:

$$\dot{m}_A + \dot{m}_B = 0,$$

where:

- \dot{m}_A is the mass flow rate at port **A**.
- \dot{m}_B is the mass flow rate at port **B**.

Energy Balance

Energy is conserved in the valve:

$$\Phi_A + \Phi_B = 0,$$

where:

- Φ_A is the energy flow at port **A**.
- Φ_B is the energy flow at port **B**.

Assumptions and Limitations

- The block does not model pressure recovery downstream of the valve.
- There is no heat exchange between the valve and the environment.
- The block does not model choked flow.

Ports

Conserving

A — Fluid port

two-phase fluid

Fluid entry or exit port.

B — Fluid port

two-phase fluid

Fluid entry or exit port.

Input

Ps — Set pressure

physical signal

Input port for varying the set pressure signal.

Dependencies

To enable this port, set **Set pressure control** to **Controlled**.

Parameters

Set pressure control — Varying or constant set pressure

Constant (default) | Controlled

Whether the pressure threshold is constant or variable. Setting this parameter to `Controlled` exposes the physical signal port **Ps**.

Set pressure (gauge) — Pressure threshold

0.1 MPa (default) | positive scalar

Valve pressure threshold. When the control pressure, $p_B - p_{atm}$, exceeds the set pressure, the valve begins to close.

Dependencies

To enable this parameter, set **Set pressure control** to `Constant`.

Pressure regulation range — Valve operational range

0.1 MPa (default) | positive scalar

Valve operational range. The valve begins to close at the set pressure value, and is fully closed at p_{max} , the end of the pressure regulation range: $p_{max} = p_{set} + p_{range}$.

Nominal mass flow rate at maximum opening — Rated mass flow rate

0.1 kg/s (default) | positive scalar

Mass flow rate through a fully open valve under typical, design, or rated conditions.

Nominal pressure drop at maximum opening — Rated pressure drop

0.001 MPa (default) | positive scalar

Pressure drop over a fully open valve under typical, design, or rated conditions.

Nominal inlet condition specification — Method of determining inlet fluid state

Temperature (default) | Vapor quality | Vapor void fraction | Specific enthalpy | Specific internal energy

Method of determining inlet fluid state. The valve inlet specific volume is determined from the fluid properties tabulated data based on the **Nominal inlet pressure** and the setting of the **Nominal inlet condition specification** parameters.

Nominal inlet pressure — Pressure of fluid entering valve

0.101325 MPa (default) | positive scalar

Inlet pressure in typical, design, or rated conditions. The valve inlet specific volume is determined from the fluid properties tabulated data based on the **Nominal inlet pressure** and the setting of the **Nominal inlet condition specification** parameters.

Nominal inlet temperature — Fluid temperature

293.15 K (default) | positive scalar

Inlet fluid temperature in nominal operating conditions.

Dependencies

To enable this parameter, set **Nominal inlet condition specification** to Temperature.

Nominal inlet vapor quality – Inlet vapor quality by mass fraction

0.5 (default) | positive scalar in the range [0,1]

Inlet vapor quality of the mixture by mass fraction in open, nominal operating conditions. A value of 0 means that the inlet fluid is subcooled liquid. A value of 1 means that the inlet fluid is superheated vapor.

Dependencies

To enable this parameter, set **Nominal inlet condition specification** to Vapor quality.

Nominal inlet vapor void fraction – Inlet vapor quality by volume fraction

0.5 (default) | positive scalar in the range [0,1]

Inlet mixture volume fraction in nominal operating conditions. A value of 0 means that the inlet fluid is subcooled liquid. A value of 1 means that the inlet fluid is superheated vapor.

Dependencies

To enable this parameter, set **Nominal inlet condition specification** to Vapor void fraction.

Nominal inlet specific enthalpy – Inlet fluid specific enthalpy

1500 kJ/kg (default) | positive scalar

Inlet specific enthalpy in nominal operating conditions.

Dependencies

To enable this parameter, set **Nominal inlet condition specification** to Specific enthalpy.

Nominal inlet specific internal energy – Inlet specific internal energy

1500 kJ/kg (default) | positive scalar

Inlet specific internal energy in nominal operating conditions.

Dependencies

To enable this parameter, set **Nominal inlet condition specification** to Specific internal energy.

Cross-sectional area at ports A and B – Valve port areas

0.01 m² (default) | positive scalar

Area of the valve ports **A** and **B**.

Closed valve leakage as a fraction of nominal flow – Fractional flow when valve is closed

1e-6 (default) | positive scalar

Fractional flow rate through the valve when it is fully closed. This parameter contributes to numerical stability by maintaining continuity in the fluid network.

Smoothing factor – Numerical smoothing factor

0.01 (default) | positive scalar in the range [0,1]

Continuous smoothing factor that introduces a layer of gradual change to the flow response when the valve is in near-open or near-closed positions. Set this parameter to a nonzero value less than one to increase the stability of your simulation in these regimes.

Laminar flow pressure ratio – Laminar-turbulent transition pressure ratio

0.999 (default) | positive scalar

Ratio of the valve outlet pressure to valve inlet pressure at which the fluid transitions between the laminar and turbulent regimes. The pressure loss corresponds to the mass flow rate linearly in laminar flows and quadratically in turbulent flows.

Inlet phase change time constant – Lag for mixture specific volume

0.1 s (default) | positive scalar

Time lag for liquid-vapor mixtures in computing the fluid specific volume. This parameter does not influence the specific volume when the inlet fluid is a fully supercooled liquid or fully superheated vapor.

See Also

Pressure-Reducing Valve (2P) | Check Valve (2P) | Orifice (2P) | Thermostatic Expansion Valve (2P)

Introduced in R2021a

Pressure Relief Valve

Valve used to vent pressure in excess of a preset value from a hydraulic line

Library: Simscape / Fluids / Hydraulics (Isothermal) / Valves / Pressure Control Valves



Description

The Pressure Relief Valve block models the flow through a valve that opens to vent so as to maintain a preset pressure drop between inlet (port **A**) and outlet (port **B**). The normally closed valve cracks open when the pressure drop from **A** to **B** exceeds the valve pressure setting. The valve opening area is computed as a function of the excess in the pressure drop, either a simple linear expression or a (generally nonlinear) tabulated function. The valve serves its purpose until its opening area reaches a maximum—a point at the limit of the valve regulation range, beyond which the pressure drop is again free to rise, unabated.

Valve Opening

The opening area calculation depends on the valve parameterization selected for the block: either Linear area-opening relationship or Tabulated data - Area vs. pressure.

Linear Parameterization

If the **Valve parameterization** block parameter is in the default setting of Linear area-opening relationship, the opening area is computed as:

$$S(\Delta p_{AB}) = S_{Leak} + k(\Delta p_{AB} - \Delta p_{Set}),$$

where:

- S_{Max} is the value specified in the **Maximum passage area** block parameter.
- Δp_{Set} is the value specified in the **Valve pressure setting** block parameter.
- Δp_{AB} is the pressure drop from port **A** to port **B**:

$$\Delta p_{AB} = p_A - p_B,$$

where p is the gauge pressure at the port indicated by the subscript (**A** or **B**).

- k is the linear constant of proportionality:

$$k = \frac{S_{Max} - S_{Leak}}{\Delta p_{Reg}},$$

where in turn:

- S_{Leak} is the value specified in the **Leakage area** block parameter.
- Δp_{Reg} is that specified in the **Valve regulation range** block parameter.

At and below the valve pressure setting, the opening area is that due to internal leakage alone:

$$S(\Delta p_{AB} \leq \Delta p_{Set}) = S_{Leak}$$

At and above a maximum pressure, the opening area is that of a fully open valve:

$$S(\Delta p_{AB} \geq \Delta p_{Max}) = S_{Max}$$

where the maximum pressure drop Δp_{Max} is the sum:

$$\Delta p_{Max} = \Delta p_{Set} + \Delta p_{Reg}$$

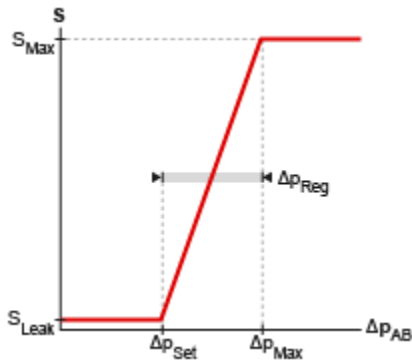

Opening area in the Linear area-opening relationship parameterization

Tabulated Parameterization

If the **Valve parameterization** block parameter is set to Tabulated data - Area vs. pressure, the opening area is computed as:

$$S = S(\Delta p_{AB}),$$

where S_{XY} is a tabulated function constructed from the **Pressure drop vector** and **Opening area vector** block parameters. The function is based on linear interpolation (for points within the data range) and nearest-neighbor extrapolation (for points outside the data range). The leakage and maximum opening areas are the minimum and maximum values of the **Valve opening area vector** block parameter.

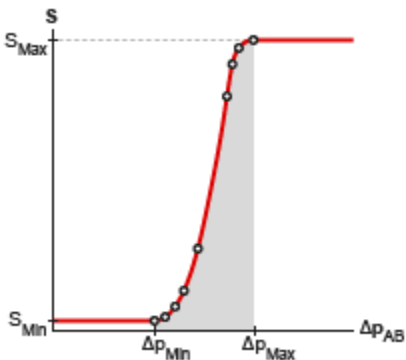

Opening area in the Tabulated data - Area vs. pressure parameterization

Opening Dynamics

By default, the valve opening dynamics are ignored. The valve is assumed to respond instantaneously to changes in the pressure drop, without time lag between the onset of a pressure disturbance and the increased valve opening that the disturbance produces. If such time lags are of consequence in a model, you can capture them by setting the **Opening dynamics** block parameter to `Include valve opening dynamics`. The valves then open each at a rate given by the expression:

$$\dot{S} = \frac{S(\Delta p_{SS}) - S(\Delta p_{In})}{\tau},$$

where τ is a measure of the time needed for the instantaneous opening area (subscript In) to reach a new steady-state value (subscript SS).

Leakage Area

The primary purpose of the leakage area of a closed valve is to ensure that at no time does a portion of the hydraulic network become isolated from the remainder of the model. Such isolated portions reduce the numerical robustness of the model and can slow down simulation or cause it to fail. Leakage is generally present in minuscule amounts in real valves but in a model its exact value is less important than its being a small number greater than zero. The leakage area is obtained from the block parameter of the same name.

Valve Flow Rate

The causes of the pressure losses incurred in the passages of the valve are ignored in the block. Whatever their natures—sudden area changes, flow passage contortions—only their cumulative effect is considered during simulation. This effect is captured in the block by the discharge coefficient, a measure of the flow rate through the valve relative to the theoretical value that it would have in an ideal valve. The flow rate through the valve is defined as:

$$q = C_D S \sqrt{\frac{2}{\rho} \frac{\Delta p_{AB}}{[(\Delta p_{AB})^2 + p_{Crit}^2]^{1/4}}},$$

where:

- q is the volumetric flow rate through the valve.
- C_D is the value of the **Discharge coefficient** block parameter.
- S is the opening area of the valve.
- Δp_{AB} is the pressure drop from port **A** to port **B**.
- p_{Crit} is the pressure differential at which the flow shifts between the laminar and turbulent flow regimes.

The calculation of the critical pressure depends on the setting of the **Laminar transition specification** block parameter. If this parameter is in the default setting of `By pressure ratio`:

$$p_{Crit} = (p_{Atm} + p_{Avg})(1 - \beta_{Crit}),$$

where:

- p_{Atm} is the atmospheric pressure (as defined for the corresponding hydraulic network).
- p_{Avg} is the average of the gauge pressures at ports **A** and **B**.

- β_{Crit} is the value of the **Laminar flow pressure ratio** block parameter.

If the **Laminar transition specification** block parameter is instead set to By Reynolds number:

$$p_{\text{Crit}} = \frac{\rho}{2} \left(\frac{Re_{\text{Crit}} \nu}{C_D D_H} \right)^2,$$

where:

- Re_{Crit} is the value of the **Critical Reynolds number** block parameter.
- ν is the kinematic viscosity specified for the hydraulic network.
- D_H is the instantaneous hydraulic diameter:

$$D_H = \sqrt{\frac{4S}{\pi}}.$$

Ports

Conserving

A – Valve inlet

hydraulic (isothermal liquid)

Opening through which the flow can enter the valve.

B – Valve outlet

hydraulic (isothermal liquid)

Opening through which the flow can exit the valve.

Parameters

Opening area parameterization – Method of calculating the opening area of the valve

Linear area-opening relationship (default) | Tabulated data - Area vs. pressure

Method by which to calculate the opening area of the valve. The default setting prescribes a linear relationship between the opening area of the valve and the pressure drop between its sensor ports. The alternative setting allows for a general, nonlinear relationship to be specified in tabulated form.

Maximum passage area – Opening area of the valve in the fully open position

1e-4 m² (default) | positive scalar in units of area

Opening area of the valve in the fully open position. The valve is fully open if the pressure drop from port **A** to port **B** is in excess of that given by the sum of the **Valve pressure setting** and **Valve regulation range** block parameters.

Dependencies

This parameter is active when the **Opening area parameterization** block parameter is set to Linear area-pressure relationship.

Valve pressure setting – Pressure drop to maintain from port A to port B

30e5 Pa (default) | positive scalar in units of pressure

Pressure drop from port **A** to port **B** that the valve is to maintain. The valve begins to open when the pressure drop exceeds the value specified here. If the pressure drop is less than this value, the valve is maximally closed and the opening area is that given in the **Leakage area** block parameter.

Dependencies

This parameter is active when the **Opening area parameterization** block parameter is set to Linear area-pressure relationship.

Valve regulation range — Pressure drop interval over which the valve is to designed to operate

1.5e5 Pa (default) | positive scalar in units of pressure

Pressure drop interval over which the valve is designed to operate. This interval stretches from the largest pressure drop at which the valve is maximally closed to the lowest pressure drop at which the valve is fully open. Only within this range is the valve capable of maintaining the specified pressure setting.

Dependencies

This parameter is active when the **Opening area parameterization** block parameter is set to Linear area-pressure relationship.

Flow Discharge coefficient — Empirical factor defined as the ratio of actual to ideal mass flow rates

0.7 (default) | positive unitless scalar

Ratio of the actual flow rate through the valve to the theoretical value that it would have in an ideal valve. This semi-empirical parameter measures the flow allowed through the valve: the greater its value, the greater the flow rate. Refer to the valve data sheet, if available, for this parameter.

Leakage area — Opening area of the valve in the maximally closed position

1e-10 m² (default) | positive scalar in units of area

Opening area of the valve in the fully closed position, when only internal leakage between its ports remains. This parameter serves primarily to ensure that closure of the valve does not cause portions of the thermal liquid network to become isolated. The exact value specified here is less important than its being a small number greater than zero.

Dependencies

This parameter is active when the **Opening area parameterization** block parameter is set to Linear area-pressure relationship.

Pressure differential vector — Vector of pressure drops at which to tabulate the valve opening areas

[30.15E5 : 15E3 : 31.35E5] Pa (default) | vector of positive numbers in units of pressure

Vector of pressure drops from port **A** to port **B** at which to specify the opening area of the valve. The vector elements must increase monotonically from left to right. This order is important when specifying the **Opening area vector** block parameter.

The block uses this data to construct a lookup table by which to determine from the gauge pressure at port **B** the valve opening area. Data is handled with linear interpolation (within the tabulated data range) and nearest-neighbor extrapolation (outside of the range).

Dependencies

This parameter is active when the **Opening area parameterization** block parameter is set to Tabulated data - Area vs. pressure.

Opening area vector — Vector of opening areas at the specified pressure differential breakpoints

[9E-5 : -1 : 1E-5] m² (default) | vector of positive numbers in units of area

Vector of opening areas corresponding to the breakpoints defined in the **Pressure differential vector** block parameter. The vector elements must increase monotonically from left to right (the direction of increasing pressure). For best results, avoid regions of flattened slope.

The block uses this data to construct a lookup table by which to determine from the pressure differential the valve opening area. Data is handled with linear interpolation (within the tabulated data range) and nearest-neighbor extrapolation (outside of the range).

Dependencies

This parameter is active when the **Opening area parameterization** block parameter is set to Tabulated data - Area vs. pressure.

Laminar transition specification — Parameter in terms of which to define the boundary between laminar and turbulent regimes

Pressure ratio (default) | Reynolds number

Parameter in terms of which to specify the boundary between the laminar and turbulent flow regimes. The pressure ratio of the default parameterization is defined as the gauge pressure at the outlet divided by the same at the inlet.

Laminar flow pressure ratio — Pressure ratio at which the flow transitions between laminar and turbulent regimes

0.999 (default) | positive unitless scalar

Pressure ratio at which the flow is assumed to transition between laminar and turbulent regimes. The pressure ratio is defined as the gauge pressure at the outlet divided by the same at the inlet. The transition is assumed to be smooth and centered on this value.

Dependencies

This parameter is active when the **Laminar transition specification** block parameter is set to Reynolds number.

Critical Reynolds number — Reynolds number at the boundary between laminar and turbulent flow regimes

12 (default) | positive unitless scalar

Reynolds number at which the flow is assumed to transition between laminar and turbulent regimes.

Dependencies

This parameter is active when the **Laminar transition specification** block parameter is set to Pressure ratio.

Opening dynamics — Choice of whether to capture the opening dynamics of the valve

Do not include valve opening dynamics (default) | Include valve opening dynamics

Choice of whether to capture the opening dynamics of the valve. Selecting `Include valve opening dynamics` causes the valve to open gradually, so as to approach its new steady-state area over a small time span. The characteristic time for such transitions is given in the **Opening time constant** block parameter.

Setting this parameter to the alternative `Do not include valve opening dynamics` is equivalent to specifying a value of ∞ for the opening time constant. The opening area is in this case assumed to reach its new steady-state value instantaneously.

Include opening dynamics to more accurately capture the behavior of a real valve. For best real-time simulation performance, use with a local solver or disable valve opening dynamics altogether.

Opening time constant — Characteristic time scale of the valve opening transitions

0.1 s (default) | positive scalar in units of time

Measure of the time taken by the valve to transition from its current opening area to a new steady-state value. The block uses this parameter to calculate the rate at which a valve is opening and from it the instantaneous opening area at the next time step.

Dependencies

This parameter is active when the **Opening dynamics** block parameter is set to `Include valve opening dynamics`.

Initial area — Opening area at the start of simulation

1e-12 m² (default) | positive scalar in units of area

Area normal to the direction of flow within the valve at the start of simulation. The block uses this parameter to calculate the initial rate at which the valve is opening and from it the instantaneous opening area at the next time step.

Dependencies

This parameter is active when the **Opening dynamics** block parameter is set to `Include valve opening dynamics`.

Extended Capabilities

C/C++ Code Generation

Generate C and C++ code using Simulink® Coder™.

See Also

Pressure Compensator | Pressure Reducing 3-Way Valve | Pressure Reducing Valve

Topics

“Upgrading Simscape Fluids Models Containing Hydraulics (Isothermal) Blocks”

Introduced in R2016a

Pressure Relief Valve (IL)

Pressure-relief valve in an isothermal system

Library: Simscape / Fluids / Isothermal Liquid / Valves & Orifices / Pressure Control Valves



Description

The Pressure Relief Valve (IL) models a pressure-relief valve in an isothermal liquid network. The valve remains closed when the pressure is less than a specified value. When this pressure is met or surpassed, the valve opens. This set pressure is either a threshold pressure differential over the valve, between ports **A** and **B**, or between port **A** and atmospheric pressure. For pressure control based on another element in the fluid system, see the Pressure Compensator Valve (IL) block.

Pressure Control

Two valve control options are available:

- When **Set pressure control** is set to **Controlled**, connect a pressure signal to port **Ps** and define the constant **Pressure regulation range**. The valve response will be triggered when P_{control} , the pressure differential between ports **A** and **B**, is greater than P_{set} and below P_{max} . P_{max} is the sum of P_{set} and the pressure regulation range.
- When **Set pressure control** is set to **Constant**, the valve opening is continuously regulated between P_{set} and P_{max} . There are two options for pressure regulation available in the **Pressure control specification** parameter: P_{control} can be the pressure differential between ports **A** and **B** or the pressure differential between port **A** and atmospheric pressure. The opening area is then modeled by either linear or tabular parameterization. When the **Tabulated data** option is selected, P_{set} and P_{max} are the first and last parameters of the **Pressure differential vector**, respectively.

Mass Flow Rate Equation

Momentum is conserved through the valve:

$$\dot{m}_A + \dot{m}_B = 0.$$

The mass flow rate through the valve is calculated as:

$$\dot{m} = \frac{C_d A_{\text{valve}} \sqrt{2\bar{\rho}}}{\sqrt{PR_{\text{loss}} \left(1 - \left(\frac{A_{\text{valve}}}{A_{\text{port}}} \right)^2 \right)}} \frac{\Delta p}{[\Delta p^2 + \Delta p_{\text{crit}}^2]^{1/4}},$$

where:

- C_d is the **Discharge coefficient**.
- A_{valve} is the instantaneous valve open area.

- A_{port} is the **Cross-sectional area at ports A and B**.
- $\bar{\rho}$ is the average fluid density.
- Δp is the valve pressure difference $p_A - p_B$.

The critical pressure difference, Δp_{crit} , is the pressure differential associated with the **Critical Reynolds number**, Re_{crit} , the flow regime transition point between laminar and turbulent flow:

$$\Delta p_{crit} = \frac{\pi \bar{\rho}}{8 A_{valve}} \left(\frac{\nu Re_{crit}}{C_d} \right)^2.$$

Pressure loss describes the reduction of pressure in the valve due to a decrease in area. PR_{loss} is calculated as:

$$PR_{loss} = \frac{\sqrt{1 - \left(\frac{A_{valve}}{A_{port}}\right)^2 (1 - C_d^2)} - C_d \frac{A_{valve}}{A_{port}}}{\sqrt{1 - \left(\frac{A_{valve}}{A_{port}}\right)^2 (1 - C_d^2)} + C_d \frac{A_{valve}}{A_{port}}}.$$

Pressure recovery describes the positive pressure change in the valve due to an increase in area. If you do not wish to capture this increase in pressure, set the **Pressure recovery** to Off. In this case, PR_{loss} is 1.

The opening area A_{valve} is determined by the opening parameterization (for Constant valves only) and the valve opening dynamics.

Opening Parameterization

Linear parameterization of valve area is:

$$A_{valve} = \hat{p}(A_{max} - A_{leak}) + A_{leak},$$

where the normalized pressure, \hat{p} , is

$$\hat{p} = \frac{p_{control} - p_{set}}{p_{max} - p_{set}}.$$

At the extremes of the valve pressure range, you can maintain numerical robustness in your simulation by adjusting the block **Smoothing factor**. With a nonzero smoothing factor, a smoothing function is applied to all calculated valve pressures, but primarily influences the simulation at the extremes of these ranges.

When the **Smoothing factor**, f , is nonzero, a smoothed, normalized pressure is instead applied to the valve area:

$$\hat{p}_{smoothed} = \frac{1}{2} + \frac{1}{2} \sqrt{\hat{p}^2 + \left(\frac{f}{4}\right)^2} - \frac{1}{2} \sqrt{(\hat{p} - 1)^2 + \left(\frac{f}{4}\right)^2}.$$

In the **Tabulated data** parameterization, A_{leak} and A_{max} are the first and last parameters of the **Opening area vector**, respectively. The smoothed, normalized pressure is also used when the smoothing factor is nonzero with linear interpolation and nearest extrapolation.

Opening Dynamics

If **Opening dynamics** are modeled, a lag is introduced to the flow response to valve opening. A_{valve} becomes the dynamic opening area, A_{dyn} ; otherwise, A_{valve} is the steady-state opening area. The instantaneous change in dynamic opening area is calculated based on the **Opening time constant**, τ :

$$\dot{p}_{\text{dyn}} = \frac{p_{\text{control}} - p_{\text{dyn}}}{\tau}.$$

By default, **Opening dynamics** are turned Off.

Steady-state dynamics are set by the same parameterization as valve opening, and are based on the control pressure, p_{control} . A nonzero **Smoothing factor** can provide additional numerical stability when the orifice is in near-closed or near-open position.

Faulty Behavior

When faults are enabled, the valve open area becomes stuck at a specified value in response to one of these triggers:

- Simulation time — Faulting occurs at a specified time.
- Simulation behavior — Faulting occurs in response to an external trigger. This exposes port **Tr**.

Three fault options are available in the **Opening area when faulted** parameter:

- Closed — The valve freezes at its smallest value, depending on the **Opening parameterization**:
 - When **Opening parameterization** is set to Linear, the valve area freezes at the **Leakage area**.
 - When **Opening parameterization** is set to Tabulated data, the valve area freezes at the first element of the **Opening area vector**.
- Open — The valve freezes at its largest value, depending on the **Opening parameterization**:
 - When **Opening parameterization** is set to Linear, the valve area freezes at the **Maximum opening area**.
 - When **Orifice parameterization** is set to Tabulated data, the valve area freezes at the last element of the **Opening area vector**.
- Maintain last value — The valve area freezes at the valve open area when the trigger occurred.

Due to numerical smoothing at the extremes of the valve area, the minimum area applied is larger than the **Leakage area**, and the maximum is smaller than the **Maximum orifice area**, in proportion to the **Smoothing factor** value.

Once triggered, the valve remains at the faulted area for the rest of the simulation.

Ports

Conserving

A — Liquid port

isothermal liquid

Entry or exit point to the valve.

B – Liquid port

isothermal liquid

Entry or exit point to the valve.

Input

Ps – Set pressure signal

physical signal

Varying-signal set pressure for controlled valve operation.

Dependencies

To enable this port, set **Set pressure control** to `Controlled`.

Tr – External fault trigger

physical signal

Physical signal port for an external fault trigger. Triggering occurs when the value is greater than 0.5. There is no unit associated with the trigger value.

Dependencies

This port is visible when **Enable faults** is set to `On` and **Fault trigger** is set to `External`.

Parameters

Parameters

Set pressure control – Valve operation method

`Constant` (default) | `Controlled`

Valve operation method. A `Constant` valve opens linearly over a fixed pressure regulation range or in accordance with tabulated pressure and opening area data that you provide. A `Controlled` valve opens according to a variable set pressure signal at port **Ps** over a fixed pressure regulation range.

Pressure control specification – Pressure differential used for valve control

`Pressure differential` (default) | `Pressure at port A`

Pressure differential used for the valve control. Selecting `Pressure differential` sets the pressure difference between port **A** and port **B** as the trigger for pressure control. Selecting `Pressure at port A` sets the gauge pressure at port **A**, or the difference between the pressure at port **A** and atmospheric pressure, as the trigger for pressure control.

Set pressure (gauge) – Threshold pressure

`0.1 MPa` (default) | positive scalar

Gauge pressure beyond which valve operation is triggered when the **Pressure control specification** is with respect to port **A**.

Dependencies

To enable this parameter, set **Set pressure control** to Constant and **Pressure control specification** to Pressure at port A.

Set pressure differential – Threshold pressure

0 MPa (default) | positive scalar

Pressure beyond which valve operation is triggered. This is the set pressure when the **Pressure control specification** is with respect to the pressure differential between ports **A** and **B**.

Dependencies

To enable this parameter, set **Set pressure control** to Constant and **Pressure control specification** to Pressure differential.

Pressure regulation range – Valve operational pressure range

0.1 MPa (default) | positive scalar

Operational pressure range of the valve. The pressure regulation range begins at the valve set pressure and the end of the range is the maximum valve operating pressure.

Dependencies

To enable this parameter, set

- **Set pressure control** to Controlled
- **Set pressure control** to Constant and **Opening parameterization** to Linear

Opening parameterization – Method of modeling constant valve opening or closing

Linear (default) | Tabulated data

Method of modeling valve opening or closing. The valve opening is either parametrized linearly or by a table of values that correlate area to pressure differential.

Maximum opening area – Area of fully opened valve

$1e-4 \text{ m}^2$ (default) | positive scalar

Cross-sectional area of the valve in its fully open position.

Dependencies

To enable this parameter, set either:

- **Set pressure control** to Controlled
- **Set pressure control** to Constant and **Opening parameterization** to Linear

Leakage area – Valve gap area when in fully closed position

$1e-10 \text{ m}^2$ (default) | positive scalar

Sum of all gaps when the valve is in fully closed position. Any area smaller than this value is maintained at the specified leakage area. This contributes to numerical stability by maintaining continuity in the flow.

Dependencies

To enable this parameter, set either:

- **Set pressure control** to Controlled.
- **Set pressure control** to Constant and **Opening parameterization** to Linear

Pressure differential vector – Differential pressure values for tabular parameterization

[0.2 : 0.2 : 1.2] MPa (default) | 1-by-*n* vector

Vector of pressure differential values for the tabular parameterization of the valve opening area. The vector elements must correspond one-to-one with the elements in the **Opening area vector** parameter. The elements are listed in ascending order and must be greater than 0. Linear interpolation is employed between table data points.

Dependencies

To enable this parameter, set **Set pressure control** to Constant and **Opening parameterization** to Tabulated data.

Opening area vector – Valve opening areas for tabular parameterization

[1e-10, 2e-06, 4e-06, 6e-06, 8e-06, 1e-05] m² (default) | 1-by-*n* vector

Vector of valve opening areas for the tabular parameterization of the valve opening area. The vector elements must correspond one-to-one with the elements in the **Pressure differential vector** parameter. The elements are listed in ascending order and must be greater than 0. Linear interpolation is employed between table data points.

Dependencies

To enable this parameter, set **Set pressure control** to Constant and **Opening parameterization** to Tabulated data.

Cross-sectional area at ports A and B – Area at valve entry or exit

inf m² (default) | positive scalar

Cross-sectional area at the entry and exit ports **A** and **B**. These areas are used in the pressure-flow rate equation determining mass flow rate through the valve.

Discharge coefficient – Discharge coefficient

0.64 (default) | positive scalar

Correction factor accounting for discharge losses in theoretical flows. The default discharge coefficient for a valve in Simscape Fluids is 0.64.

Critical Reynolds number – Upper Reynolds number limit for laminar flow

150 (default) | positive scalar

Upper Reynolds number limit for laminar flow through the valve.

Smoothing factor – Numerical smoothing factor

0.01 (default) | positive scalar

Continuous smoothing factor that introduces a layer of gradual change to the flow response when the valve is in near-open or near-closed positions. Set this value to a nonzero value less than one to increase the stability of your simulation in these regimes.

Pressure recovery – Whether to account for pressure increase in area expansions

Off (default) | On

Accounts for pressure increase when fluid flows from a region of smaller cross-sectional area to a region of larger cross-sectional area. This increase in pressure is not captured when **Pressure recovery** is set to **Off**.

Opening dynamics — Whether to account for flow response to valve opening

Off (default) | On

Whether to account for transient effects to the fluid system due to valve opening. Setting **Opening dynamics** to **On** approximates the opening conditions by introducing a first-order lag in the flow response. The **Opening time constant** also impacts the modeled opening dynamics.

Initial opening area — Open area at the start of the simulation

1e-10 m² (default) | positive scalar

Initial cross-sectional area of the opening at the time of dynamic opening. This value is used to calculate the instantaneous opening area at the following time step.

Dependencies

To enable this parameter, set **Opening dynamics** to **On**.

Opening time constant — Valve opening time constant

0.1 s (default) | positive scalar

Constant that captures the time required for the fluid to reach steady-state when opening or closing the valve from one position to another. This parameter impacts the modeled opening dynamics.

Dependencies

To enable this parameter, set **Opening dynamics** to **On**.

Faults**Enable faults — Fault option**

Off (default) | On

Enable externally or temporally triggered faults. When faulting occurs, the valve area normally set by the opening parameterization will be set to the value specified in the **Opening area when faulted** parameter.

Opening area when faulted — Set faulted characteristics

Closed (default) | Open | Maintain last value

Sets the faulted valve type. You can choose for the valve to seize when the valve is opened, closed, or at the area when faulting is triggered.

Dependencies

To enable this parameter, set **Enable faults** to **On**.

Fault trigger — External or temporal trigger option

Temporal (default) | External

Whether a fault trigger occurs due to an external event or at a specified time.

When set to **External**, port **Tr** is enabled. A physical signal at port **Tr** that is greater than 0.5 triggers faulting.

When set to **Temporal**, when the **Simulation time for fault event** is reached, the valve area will be set to the value specified in the **Opening area when faulted** parameter.

Dependencies

To enable this parameter, set **Enable faults** to On.

Simulation time for fault event – Time at which faulting is triggered

5 s (default) | positive scalar

When the **Simulation time for fault event** is reached, the valve area is set to the value specified in the **Opening area when faulted** parameter.

Dependencies

To enable this parameter, set **Enable faults** to On and **Fault trigger** to **Temporal**.

See Also

Pressure Compensator Valve (IL) | Pressure-Compensated 3-Way Flow Control Valve (IL) | Pressure-Compensated Flow Control Valve (IL) | Check Valve (IL) | Counterbalance Valve (IL)

Introduced in R2020a

Pressure Relief Valve (G)

Valve for venting fluid when at excessive pressure

Library: Simscape / Fluids / Gas / Valves & Orifices / Pressure Control Valves



Description

The Pressure Relief Valve (G) block models an orifice that opens with inlet pressure so as to keep its level from reaching extreme levels. At normal pressures, the valve is closed and only leakage flow develops. Above a specified pressure setting, the valve begins to open, allowing the gas to vent from its region of high pressure. The opening area increases with inlet pressure up to a maximum value, at which point the valve is fully open and pressure is again free to rise unabated.

The valve responds to either of two inlet pressure measurements—one relative to the outlet or to the environment. The chosen pressure measurement is referred to as the *control pressure* of the valve and it impacts the calculations of the block. The **Control pressure specification** block parameter determines which of the measurements the block uses during simulation.

The relationship between the opening area and the pressure drop depends on the parameterization of the valve. That relationship can take the form of a linear analytical expression or of a (generally nonlinear) tabulated function.

The flow can be laminar or turbulent, and it can reach (up to) sonic speeds. This happens at the vena contracta, a point just past the throat of the valve where the flow is both its narrowest and fastest. The flow then chokes and its velocity saturates, with a drop in downstream pressure no longer sufficing to increase its velocity. Choking occurs when the back-pressure ratio hits a critical value characteristic of the valve. Supersonic flow is not captured by the block.

Control and Other Pressures

The pressure at the inlet serves as the control signal of the valve. The greater its rise over the valve's pressure setting, the greater the opening area becomes. The inlet pressure measurement, however, can be relative to the outlet or the environment. The choice of reference depends on the setting of the **Pressure control specification** block parameter—either **Pressure differential** or **Pressure at port A**. The term *control pressure* is used here to refer to both measurements.

Pressure differential

When the **Pressure control specification** parameter is set to **Pressure differential** (the default setting), the control pressure is computed as:

$$p_{Ctl} = p_A - p_B,$$

where p is instantaneous pressure. The subscript *Ctl* denotes the control value and the subscripts **A** and **B** the inlet and outlet, respectively. The port pressures are instantaneous values determined during simulation. The pressure setting is likewise defined as:

$$P_{\text{Set}} = [P_A - P_B]_{\text{Set}},$$

where P is a constant pressure parameter. The subscript **Set** denotes the valve setting (here a differential). The term in parentheses is obtained as a constant from the **Set pressure differential** block parameter. Similarly for the maximum pressure of the valve (at which the valve is fully open):

$$P_{\text{Max}} = P_{\text{Set}} + \Delta P,$$

where ΔP refers specifically to the pressure regulation range of the valve, obtained as a constant from the block parameter of the same name. The subscript **Max** denotes the maximum value.

Pressure at port A

When the **Pressure control specification** parameter is set to **Pressure at port A**, the control pressure is computed as:

$$p_{\text{Ctl}} = p_A + p_{\text{Atm}},$$

where the subscript **Atm** denotes the atmospheric value (specified for the model as a constant in the Gas Properties (G) block of the Simscape Foundation library). The port pressure is an instantaneous value determined during simulation. For the pressure setting:

$$P_{\text{Set}} = P_{\text{A,Set}} + P_{\text{Atm}},$$

where the subscript **A,Set** denotes the valve setting, specified as a gauge pressure at port **A**. This value is obtained as a constant from the **Set pressure (gauge)** block parameter. The maximum pressure of the valve is:

$$P_{\text{Max}} = P_{\text{Set}} + \Delta P,$$

(where, as before, ΔP refers specifically to the pressure regulation range of the valve).

Control Pressure Overshoot

The degree to which the control pressure exceeds the pressure setting determines how much the valve will open. The pressure overshoot is expressed here as a fraction of the (width of the) pressure regulation range:

$$\hat{p} = \frac{p_{\text{Ctl}} - p_{\text{Set}}}{\Delta P}.$$

The control pressure (p_{Ctl}), pressure setting (p_{Set}), and pressure regulation range (ΔP) are those defined for the control pressure specification chosen (**Pressure differential** or **Pressure at port A**).

The fraction—technically, the overshoot *normalized*—is valued at 0 in the fully closed valve and 1 in the fully open valve. If the calculation should return a value outside of these bounds, the nearest of the two is used instead. (In other words, the fraction *saturates* at 0 and 1.)

Numerical Smoothing

The normalized (and saturated) control pressure overshoot spans three regions. Below the pressure setting of the valve, its value is a constant zero. Above the maximum pressure—the sum of the pressure setting and the pressure regulation range—it is 1. In between, it varies, as a linear function of the control pressure measurement, p_{Ctl} .

The transitions between the regions are sharp and their slopes discontinuous. These pose a challenge to variable-step solvers (the sort commonly used with Simscape models). To precisely capture discontinuities, referred to in some contexts as *zero crossing events*, the solver must reduce its time step, pausing briefly at the time of the crossing in order to recompute its Jacobian matrix (a representation of the dependencies between the state variables of the model and their time derivatives).

This solver strategy is efficient and robust when discontinuities are present. It makes the solver less prone to convergence errors—but it can considerably extend the time needed to finish the simulation run, perhaps excessively so for practical use in real-time simulation. An alternative approach, used here, is to remove the discontinuities altogether.

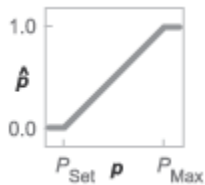

Normalized pressure overshoot with sharp transitions

The block removes the discontinuities by smoothing them over a specified time scale. The smoothing, which adds a slight distortion to the control pressure overshoot, ensures that the valve eases into its limiting positions rather than snap (abruptly) into them. The smoothing is optional: you can disable it by setting its time scale to zero. The shape and scale of the smoothing, when applied, derives in part from the cubic polynomials:

$$\lambda_L = 3\bar{p}_L^2 - 2\bar{p}_L^3$$

and

$$\lambda_R = 3\bar{p}_R^2 - 2\bar{p}_R^3,$$

where

$$\bar{p}_L = \frac{\hat{p}}{\Delta p^*}$$

and

$$\bar{p}_R = \frac{\hat{p} - (1 - \Delta p^*)}{\Delta p^*}.$$

In the equations:

- λ_L is the smoothing expression for the transition from the maximally closed position.
- λ_R is the smoothing expression for the transition from the fully open position.
- Δp^* is the (unitless) characteristic width of the pressure smoothing region:

$$\Delta p^* = f^* \frac{1}{2},$$

where f^* is a smoothing factor valued between 0 and 1 and obtained from the block parameter of the same name.

When the smoothing factor is 0, the control pressure overshoot stays in its original form—no smoothing applied—and its transitions remain abrupt. When it is 1, the smoothing spans the whole of the pressure regulation range (with the control pressure overshoot taking the shape of an S-curve).

At intermediate values, the smoothing is limited to a fraction of that range. A value of 0.5, for example, will smooth the transitions over a quarter of the pressure regulation range on each side (for a total smooth region of half the regulation range).

The smoothing adds two new regions to the control pressure overshoot—one for the smooth transition on the left, another for that on the right, giving a total of five regions. These are expressed in the piecewise function:

$$\hat{p}^* = \begin{cases} 0, & \hat{p} \leq 0 \\ \hat{p}\lambda_L, & \hat{p} < \Delta P^* \\ \hat{p}, & \hat{p} \leq 1 - \Delta P^*, \\ \hat{p}(1 - \lambda_R) + \lambda_R, & \hat{p} < 1 \\ 1 & \hat{p} \geq 1 \end{cases}$$

where the asterisk denotes a smoothed variable. The figure shows the effect of smoothing on the sharpness of the transitions.

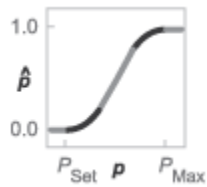

Sonic Conductance

As the normalized control pressure varies during simulation, so does the mass flow rate through the valve. The relationship between the two variables, however, is indirect. The mass flow rate is defined in terms of the valve's sonic conductance and it is this quantity that the normalized inlet pressure determines.

Sonic conductance, if you are unfamiliar with it, describes the ease with which a gas will flow when it is choked—when its velocity is at its theoretical maximum (the local speed of sound). Its measurement and calculation are covered in detail in the ISO 6358 standard (on which this block is based).

Only one value is commonly reported in valve data sheets: one taken at steady state in the fully open position. This is the same specified in the **Sonic conductance at maximum flow** parameter when the **Valve parameterization** setting is **Sonic conductance**. For values across the opening range of the valve, this maximum is scaled by the normalized pressure overshoot:

$$C = (C_{\text{Max}} - C_{\text{Min}})\hat{p} + C_{\text{Min}}$$

where C is sonic conductance and the subscripts **Max** and **Min** denote its values in the fully open and fully closed valve.

Other Parameterizations

Because sonic conductance may not be available (or the most convenient choice for your model), the block provides several equivalent parameterizations. Use the **Valve parameterization** drop-down list to select the best for the data at hand. The parameterizations are:

- Restriction area
- Sonic conductance
- Cv coefficient (USCS)
- Kv coefficient (SI)

The parameterizations differ only in the data that they require of you. Their mass flow rate calculations are still based on sonic conductance. If you select a parameterization other than **Sonic conductance**, then the block converts the alternate data—the (computed) opening area or a (specified) flow coefficient—into an equivalent sonic conductance.

Flow Coefficients

The flow coefficients measure what is, at bottom, the same quantity—the flow rate through the valve at some agreed-upon temperature and pressure differential. They differ only in the standard conditions used in their definition and in the physical units used in their expression:

- C_v is measured at a generally accepted temperature of 60 °F and pressure drop of 1 PSI; it is expressed in imperial units of US gpm. This is the flow coefficient used in the model when the **Valve parameterization** block parameter is set to **Cv coefficient (USCS)**.
- K_v is measured at a generally accepted temperature of 15 °C and pressure drop of 1 bar; it is expressed in metric units of m³/h. This is the flow coefficient used in the model when the **Valve parameterization** block parameter is set to **Kv coefficient (SI)**.

Sonic Conductance Conversions

If the valve parameterization is set to **Cv Coefficient (USCS)**, the sonic conductance is computed at the maximally closed and fully open valve positions from the **Cv coefficient (SI) at maximum flow** and **Cv coefficient (SI) at leakage flow** block parameters:

$$C = (4 \times 10^{-8} C_v) m^3 / (sPa),$$

where C_v is the flow coefficient value at maximum or leakage flow. The subsonic index, m , is set to 0.5 and the critical pressure ratio, b_{cr} , is set to 0.3. (These are used in the mass flow rate calculations given in the Momentum Balance section.)

If the **Kv coefficient (SI)** parameterization is used instead, the sonic conductance is computed at the same valve positions (maximally closed and fully open) from the **Kv coefficient (USCS) at maximum flow** and **Kv coefficient (USCS) at leakage flow** block parameters:

$$C = (4.758 \times 10^{-8} K_v) m^3 / (sPa),$$

where K_v is the flow coefficient value at maximum or leakage flow. The subsonic index, m , is set to 0.5 and the critical pressure ratio, b_{cr} , is set to 0.3.

For the **Restriction area** parameterization, the sonic conductance is computed (at the same valve positions) from the **Maximum opening area**, and **Leakage area** block parameters:

$$C = (0.128 \times 4S/\pi)L / (sbar),$$

where S is the opening area at maximum or leakage flow. The subsonic index, m , is set to 0.5 while the critical pressure ratio, b_{cr} is computed from the expression:

$$0.41 + 0.272 \left[\frac{\widehat{p}(S_{Max} - S_{Leak}) + S_{Leak}}{S} \right]^{0.25}.$$

Momentum Balance

The causes of those pressure losses incurred in the passages of the valve are ignored in the block. Whatever their natures—sudden area changes, flow passage contortions—only their cumulative effect is considered during simulation. This effect is assumed to reflect entirely in the sonic conductance of the valve (or in the data of the alternate valve parameterizations).

Mass Flow Rate

When the flow is choked, the mass flow rate is a function of the sonic conductance of the valve and of the thermodynamic conditions (pressure and temperature) established at the inlet. The function is linear with respect to pressure:

$$\dot{m}_{ch} = C\rho_0 p_{in} \sqrt{\frac{T_0}{T_{in}}},$$

where:

- C is the sonic conductance inside the valve. Its value is obtained from the block parameter of the same name or by conversion of other block parameters (the exact source depending on the **Valve parameterization** setting).
- ρ is the gas density, here at standard conditions (subscript 0), obtained from the **Reference density** block parameter.
- p is the absolute gas pressure, here corresponding to the inlet (in).
- T is the gas temperature at the inlet (in) or at standard conditions (0), the latter obtained from the **Reference temperature** block parameter.

When the flow is subsonic, and therefore no longer choked, the mass flow rate becomes a nonlinear function of pressure—both that at the inlet as well as the reduced value at the outlet. In the turbulent flow regime (with the outlet pressure contained in the back-pressure ratio of the valve), the mass flow rate expression is:

$$\dot{m}_{tur} = C\rho_0 p_{in} \sqrt{\frac{T_0}{T_{in}}} \left[1 - \left(\frac{p_r - b_{cr}}{1 - b_{cr}} \right)^2 \right]^m,$$

where:

- p_r is the back-pressure ratio, or that between the outlet pressure (p_{out}) and the inlet pressure (p_{in}):

$$P_r = \frac{p_{out}}{p_{in}}$$

- b_{cr} is the critical pressure ratio at which the flow becomes choked. Its value is obtained from the block parameter of the same name or by conversion of other block parameters (the exact source depending on the **Valve parameterization** setting).
- m is the *subsonic index*, an empirical coefficient used to more accurately characterize the behavior of subsonic flows. Its value is obtained from the block parameter of the same name or by

conversion of other block parameters (the exact source depending on the **Valve parameterization** setting).

When the flow is laminar (and still subsonic), the mass flow rate expression changes to:

$$\dot{m}_{\text{laminar}} = C \rho_0 p_{\text{in}} \left[\frac{1 - p_r}{1 - b_{\text{laminar}}} \sqrt{\frac{T_0}{T_{\text{in}}}} \left[1 - \left(\frac{b_{\text{laminar}} - b_{\text{cr}}}{1 - b_{\text{cr}}} \right)^2 \right]^m \right]$$

where b_{laminar} is the critical pressure ratio at which the flow transitions between laminar and turbulent regimes (obtained from the **Laminar flow pressure ratio** block parameter). Combining the mass flow rate expressions into a single (piecewise) function, gives:

$$\dot{m} = \begin{cases} \dot{m}_{\text{laminar}}, & b_{\text{laminar}} \leq p_r < 1 \\ \dot{m}_{\text{turbulent}}, & b_{\text{cr}} \leq p_r < b_{\text{laminar}}, \\ \dot{m}_{\text{choked}}, & p_r < b_{\text{cr}} \end{cases}$$

with the top row corresponding to subsonic and laminar flow, the middle row to subsonic and turbulent flow, and the bottom row to choked (and therefore sonic) flow.

Mass Balance

The volume of fluid inside the valve, and therefore the mass of the same, is assumed to be very small and it is, for modeling purposes, ignored. As a result, no amount of gas can accumulate there. By the principle of conservation of mass, the mass flow rate into the valve through one port must therefore equal that out of the valve through the other port:

$$\dot{m}_A + \dot{m}_B = 0,$$

where \dot{m} is defined as the mass flow rate *into* the valve through port **A** or **B**. Note that in this block the flow can reach but not exceed sonic speeds.

Energy Balance

The valve is modeled as an adiabatic component. No heat exchange can occur between the gas and the wall that surrounds it. No work is done on or by the gas as it traverses from inlet to outlet. With these assumptions, energy can flow by advection only, through ports **A** and **B**. By the principle of conservation of energy, the sum of the port energy flows must then always equal zero:

$$\phi_A + \phi_B = 0,$$

where ϕ is defined as the energy flow rate *into* the valve through one of the ports (**A** or **B**).

Ports

Conserving

A – Valve entrance

gas

Opening through which the working fluid must enter the valve.

B – Valve entrance

gas

Opening through which the working fluid must exit the valve.

Parameters

Pressure control specification — Choice of pressure measurement to use as valve control signal

Pressure differential (default) | Pressure at port A

Choice of pressure measurement to use as valve control signal. The block uses this setting to determine when the valve should begin to open. In the default setting (Pressure differential), the opening pressure of the valve is expressed as a pressure drop from inlet to outlet. In the alternative setting (Pressure at port A), it is expressed as a gauge inlet pressure. This parameter determines which of the two measures appears as a parameter in the block dialog box.

Set pressure differential — Threshold differential for valve operation

0 MPa (default) | positive scalar in units of pressure

Pressure drop, from inlet to outlet, required to open the valve. This value marks the beginning of the pressure regulation range, over which the valve progressively opens in an effort to contain a pressure rise. The opening area of the valve depends on the difference between the actual pressure drop to the value specified here.

Dependencies

This parameter is active and exposed in the block dialog box when the **Pressure control specification** parameter is set to Pressure differential.

Set pressure (gauge) — Inlet gauge pressure required to open the valve

0.1 MPa (default) | positive scalar in units of pressure

Inlet gauge pressure required to open the valve. This parameter marks the beginning of the pressure regulation range, over which the valve progressively opens in an effort to contain a pressure rise. The opening area of the valve depends on the difference between the actual inlet pressure to the value specified here.

Dependencies

This parameter is active and exposed in the block dialog box when the **Pressure control specification** parameter is set to Pressure at port A.

Pressure regulation range — Width of the pressure range over which the opening area is variable

0.1 MPa (default) | positive scalar in units of pressure

Width of the pressure range over which the opening area of the valve is variable. The pressure range begins at the set pressure measurement specified in the block (Set pressure differential or **Pressure at port A**), depending on the setting of the **Pressure control specification** parameter). It ends at the sum of the set pressure with the value specified here. The smaller the pressure regulation range, the faster the valve reaches its maximum opening area.

Valve parameterization — Method by which to characterize the opening of the valve

Sonic conductance (default) | Cv coefficient (USCS) | Kv coefficient (SI) | Restriction area

Choice of ISO method to use in the calculation of mass flow rate. All calculations are based on the **Sonic conductance** parameterization; if a different option is selected, the data specified in

converted into equivalent sonic conductance, critical pressure ratio, and subsonic index. See the block description for more information on the conversion.

This parameter determines which measures of valve opening you must specify—and therefore which of those measures appear as parameters in the block dialog box.

Opening parameterization — Method by which to calculate the opening characteristics of the valve

Linear (default) | Tabulated data

Method by which to calculate the opening area of the valve. The default setting treats the opening area as a linear function of the orifice opening fraction. The alternative setting allows for a general, nonlinear relationship to be specified (in tabulated form).

Sonic conductance at maximum flow — Measure of maximum flow rate at reference upstream conditions

1.6 l/s/bar (default) | positive scalar in units of volume/time/pressure

Equivalent measure of the maximum flow rate allowed through the valve at some reference inlet conditions, generally those outlined in ISO 8778. The flow is at a maximum when the valve is fully open and the flow velocity is choked (it being saturated at the local speed of sound). This is the value generally reported by manufacturers in technical data sheets.

Sonic conductance is defined as the ratio of the mass flow rate through the valve to the product of the pressure and density upstream of the valve inlet. This parameter is often referred to in the literature as the *C-value*.

Dependencies

This parameter is active and exposed in the block dialog box when the **Valve parameterization** setting is **Sonic conductance**.

Sonic conductance at leakage flow — Measure of minimum flow rate at reference upstream conditions

1e-5 l/s/bar (default) | positive scalar in units of volume/time/pressure

Equivalent measure of the minimum flow rate allowed through the valve at some reference inlet conditions, generally those outlined in ISO 8778. The flow is at a minimum when the valve is maximally closed and only a small leakage area—due to sealing imperfections, say, or natural valve tolerances—remains between its ports.

Sonic conductance is defined as the ratio of the mass flow rate through the valve to the product of the pressure and density upstream of the valve inlet. This parameter is often referred to in the literature as the *C-value*.

This parameter serves primarily to ensure that closure of the valve does not cause portions of the gas network to become isolated (a condition known to cause problems in simulation). The exact value specified here is less important than its being a (very small) number greater than zero.

Dependencies

This parameter is active and exposed in the block dialog box when the **Valve parameterization** setting is **Sonic conductance**.

Critical pressure ratio — Back-pressure ratio, at reference upstream conditions, at which the flow rate is a maximum

0.3 (default) | positive unitless scalar

Ratio of downstream to upstream absolute pressures at which the flow becomes choked (and its velocity becomes saturated at the local speed of sound). This parameter is often referred to in the literature as the *b-value*. Enter a number greater than or equal to zero and smaller than the **Laminar flow pressure ratio** block parameter.

Dependencies

This parameter is active and exposed in the block dialog box when the **Valve parameterization** setting is **Sonic conductance**.

Subsonic index — Exponent used to more accurately characterize flow in the subsonic regime

0.5 (default) | positive unitless scalar

Empirical exponent used to more accurately calculate the mass flow rate through the valve when the flow is subsonic. This parameter is sometimes referred to as the *m-index*. Its value is approximately 0.5 for valves (and other components) whose flow paths are fixed.

Dependencies

This parameter is active and exposed in the block dialog box when the **Valve parameterization** setting is **Sonic conductance**.

Cv coefficient (USCS) at maximum flow — Flow coefficient of the fully open valve expressed in US customary units0.4 (default) | positive scalar in units of ft³/min

Flow coefficient of the fully open valve, expressed in the US customary units of ft³/min (as described in NFPA T3.21.3). This parameter measures the relative ease with which the gas will traverse the valve when driven by a given pressure differential. This is the value generally reported by manufacturers in technical data sheets.

Dependencies

This parameter is active and exposed in the block dialog box when the **Valve parameterization** setting is **Cv coefficient (USCS)**.

Cv coefficient (USCS) at leakage flow — Flow coefficient of the maximally closed valve expressed in US customary units1e-6 (default) | positive scalar in units of ft³/min

Flow coefficient of the maximally closed valve, expressed in the US customary units of ft³/min (as described in NFPA T3.21.3). This parameter measures the relative ease with which the gas will traverse the valve when driven by a given pressure differential.

The purpose of this parameter is primarily to ensure that closure of the valve does not cause portions of the gas network to become isolated (a condition known to cause problems in simulation). The exact value specified here is less important than its being a (very small) number greater than zero.

Dependencies

This parameter is active and exposed in the block dialog box when the **Valve parameterization** setting is **Cv coefficient (USCS)**.

Kv coefficient (SI) at maximum flow — Flow coefficient of the fully open valve expressed in SI units0.3 (default) | positive scalar in units of m^3/hr

Flow coefficient of the fully open valve, expressed in the SI units of m^3/hr . This parameter measures the relative ease with which the gas will traverse the valve when driven by a given pressure differential. This is the value generally reported by manufacturers in technical data sheets.

Dependencies

This parameter is active and exposed in the block dialog box when the **Valve parameterization** setting is **Kv coefficient (SI)**.

Kv coefficient (SI) at leakage flow — Flow coefficient of the maximally closed valve expressed in SI units1e-6 (default) | positive scalar in units of m^3/hr

Flow coefficient of the maximally closed valve, expressed in the SI units of m^3/hr . This parameter measures the relative ease with which the gas will traverse the valve when driven by a given pressure differential.

The purpose of this parameter is primarily to ensure that closure of the valve does not cause portions of the gas network to become isolated (a condition known to cause problems in simulation). The exact value specified here is less important than its being a (very small) number greater than zero.

Dependencies

This parameter is active and exposed in the block dialog box when the **Valve parameterization** setting is **Kv coefficient (SI)**.

Maximum opening area — Opening area in the fully open position due to sealing imperfections1e-4 m^2 (default) | positive scalar in units of area

Opening area of the valve in the fully open position, when the valve is at the upper limit of the pressure regulation range. The block uses this parameter to scale the chosen measure of valve opening—sonic conductance, say, or C_V flow coefficient—throughout the pressure regulation range.

Dependencies

This parameter is active and exposed in the block dialog box when the **Valve parameterization** setting is **Restriction area**.

Leakage area — Opening area in the maximally closed position due to sealing imperfections1e-12 m^2 (default) | positive scalar in units of area

Opening area of the valve in the maximally closed position, when only internal leakage between the ports remains. This parameter serves primarily to ensure that closure of the valve does not cause portions of the gas network to become isolated (a condition known to cause problems in simulation). The exact value specified here is less important than its being a (very small) number greater than zero.

Dependencies

This parameter is active and exposed in the block dialog box when the **Valve parameterization** setting is **Restriction area**.

Control pressure (gauge) vector — Vector of control pressures at which to specify valve opening data

[0.2:0.2:1.2] MPa (default) | vector in units of pressure

Vector of control pressures at which to specify the chosen measure of valve opening—sonic conductance, flow coefficient (in SI or USCS forms), or opening area. This vector must be equal in size to that (or those) containing the valve opening data. The vector elements must be positive and increase monotonically in value from left to right.

The first vector element gives the pressure setting of the valve (at which the valve begins to open). This element is equivalent to the **Set pressure** parameter of the Linear opening parameterizations. The last element gives the maximum pressure, at which the valve is fully open. The difference between the two gives the pressure regulation range of the valve.

The definition of control pressure depends on the setting of the **Pressure control specification** parameter. It is either the pressure drop from inlet to outlet (Pressure differential setting) or the gauge pressure at the inlet (Pressure at port A setting).

Dependencies

This parameter is active and exposed in the block dialog box when the **Opening parameterization** setting is Tabulated data.

Sonic conductance vector — Vector of sonic conductances at given control pressures

[1e-05, .32, .64, .96, 1.28, 1.6] l/s/bar (default) | vector with units of volume/time/pressure

Vector of sonic conductances at the given valve control pressures. The sonic conductances each correspond to an element in the **Control pressure (gauge) vector** parameter, with the latter serving (in a Cartesian plot) as the abscissa and the former as the ordinate. The two vectors—of sonic conductances and control pressures—must be the same in size.

Sonic conductance measures the flow rate through the fully open valve at the onset of choking (when the flow reaches its maximum velocity, the local speed of sound). Measurements are carried out at some reference inlet conditions (generally those outlined in ISO 8778). Here, those conditions include the pressures given (as interpolation breakpoints) in the control pressure vector.

Dependencies

This parameter is active and exposed in the block dialog box when the **Valve parameterization** setting is Sonic conductance and the **Opening parameterization** setting is Tabulated data.

Critical pressure ratio vector — Vector of critical pressure ratios at given control pressures

0.3 * ones(1, 6) (default) | unitless vector

Vector of critical pressure ratios at the given valve control pressures. The ratios each correspond to an element in the **Control pressure (gauge) vector** parameter, with the latter serving (in a Cartesian plot) as the abscissa and the former as the ordinate. The two vectors—of critical pressure ratios and control pressures—must be the same in size.

The critical pressure ratio is the fraction of downstream over upstream absolute pressures at which the flow becomes choked (and its velocity becomes saturated at the local speed of sound). Measurements are carried out at some reference inlet conditions (generally those outlined in ISO 8778). Here, those conditions include the pressures given (as interpolation breakpoints) in the control pressure vector.

The values specified here must each be greater than or equal to zero and smaller than the **Laminar flow pressure ratio** block parameter.

Dependencies

This parameter is active and exposed in the block dialog box when the **Valve parameterization** setting is **Sonic conductance** and the **Opening parameterization** setting is **Tabulated data**.

Cv coefficient (USCS) vector — Vector of flow coefficients, in USCS units, at given control pressures

[1e-06, .08, .16, .24, .32, .4] (default) | vector in units of ft³/min

Vector of flow coefficients, expressed in US customary units of ft³/min (as described in NFPA T3.21.3), at the given valve control pressures. The flow coefficients each correspond to an element in the **Control pressure (gauge) vector** parameter, with the latter serving (in a Cartesian plot) as the abscissa and the former as the ordinate. The two vectors—of flow coefficients and control pressures—must be the same in size.

The flow coefficient measures the relative ease with which the flow, when subjected to some reference pressure condition, can traverse the valve. Its value is commonly reported in technical data sheets for the fully open valve (alongside the pressure condition to which the measurement corresponds). The vector elements specified here each correspond to a different measurement.

Dependencies

This parameter is active and exposed in the block dialog box when the **Valve parameterization** setting is **Cv coefficient (USCS)** and the **Opening parameterization** setting is **Tabulated data**.

Kv coefficient (SI) vector — Vector of flow coefficients, in SI units, at given control pressures

[1e-06, .06, .12, .18, .24, .3] (default) | vector in units of m³/hr

Vector of flow coefficients, expressed in SI units of m³/hr (as described in NFPA T3.21.3), at the given valve control pressures. The flow coefficients each correspond to an element in the **Control pressure (gauge) vector** parameter, with the latter serving (in a Cartesian plot) as the abscissa and the former as the ordinate. The two vectors—of flow coefficients and control pressures—must be the same in size.

The flow coefficient measures the relative ease with which the flow, when subjected to some reference pressure condition, can traverse the valve. Its value is commonly reported in technical data sheets for the fully open valve (alongside the pressure condition to which the measurement corresponds). The vector elements specified here each correspond to a different measurement.

Dependencies

This parameter is active and exposed in the block dialog box when the **Valve parameterization** setting is **Kv coefficient (SI)** and the **Opening parameterization** setting is **Tabulated data**.

Opening area vector — Vector of opening areas at given control pressures

[1e-10, 2e-06, 4e-06, 6e-06, 8e-06, 1e-05] m² (default) | vector in units of area

Vector of valve opening areas at the given control pressure breakpoints. The opening areas each correspond to an element in the **Control pressure (gauge) vector** parameter, with the latter serving (in a Cartesian plot) as the abscissa and the former as the ordinate. The two vectors—of opening areas and control pressures—must be the same in size.

The opening area is that normal to the direction of flow at the point of narrowest aperture (the location of the valve control member).

Dependencies

This parameter is active and exposed in the block dialog box when the **Valve parameterization** setting is `Restriction area` and the **Opening parameterization** setting is `Tabulated data`.

Cross-sectional area at ports A, and B — Area normal to the flow path at the valve ports

0.01 m² (default) | positive scalar in units of area

Area normal to the flow path at the valve ports. The ports are assumed to be of the same size. The flow area specified here should (ideally) match those of the inlets of adjoining components.

Smoothing factor — Amount of smoothing to apply to the valve opening function

0 (default) | positive unitless scalar

Amount of smoothing to apply to the opening function of the valve. This parameter determines the widths of the regions to be smoothed—one located at the fully open position, the other at the fully closed position.

The smoothing superposes on each region of the opening function a nonlinear segment (a third-order polynomial function, from which the smoothing arises). The greater the value specified here, the greater the smoothing is, and the broader the nonlinear segments become.

At the default value of 0, no smoothing is applied. The transitions to the maximally closed and fully open positions then introduce discontinuities (associated with zero-crossings). These can slow down the rate of simulation.

Laminar flow pressure ratio — Pressure ratio at which the flow transitions between laminar and turbulent regimes

0.999 (default) | positive unitless scalar

Pressure ratio at which the flow transitions between laminar and turbulent flow regimes. The pressure ratio is the fraction of the absolute pressure downstream of the valve over that just upstream of it. The flow is laminar when the actual pressure ratio is above the threshold specified here and turbulent when it is below. Typical values range from 0.995 to 0.999.

Reference temperature — ISO 8778 reference temperature

293.15 K (default) | scalar in units of temperature

Temperature at standard reference atmosphere, defined as 293.15 K in ISO 8778.

Reference density — ISO 8778 reference density

1.185 (default) | positive scalar in units of mass/volume

Density at standard reference atmosphere, defined as 1.185 kg/m³ in ISO 8778.

Extended Capabilities

C/C++ Code Generation

Generate C and C++ code using Simulink® Coder™.

See Also

Variable Orifice ISO 6358 (G) | Pressure Reducing Valve (G)

Introduced in R2018b

Pressure Relief Valve (TL)

Pressure control valve for maintaining preset pressure in fluid network

Library: Simscape / Fluids / Thermal Liquid / Valves & Orifices / Pressure Control Valves



Description

The Pressure Relief Valve (TL) block represents a valve for maintaining a preset pressure in a fluid network. The valve remains closed until the pressure at port A reaches the valve set pressure. A pressure rise above the set pressure causes the valve to gradually open, allowing the fluid network to relieve excess pressure.

A smoothing function allows the valve opening area to change smoothly between the fully closed and fully open positions. The smoothing function does this by removing the abrupt opening area changes at the zero and maximum ball positions. The figure shows the effect of smoothing on the valve opening area curve.

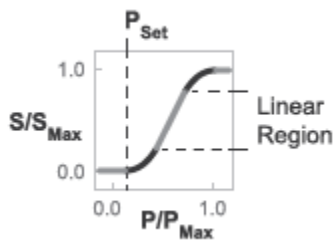

Opening-Area Curve Smoothing

Mass Balance

The mass conservation equation in the valve is

$$\dot{m}_A + \dot{m}_B = 0,$$

where:

- \dot{m}_A is the mass flow rate into the valve through port A.
- \dot{m}_B is the mass flow rate into the valve through port B.

Momentum Balance

The momentum conservation equation in the valve is

$$p_A - p_B = \frac{\dot{m} \sqrt{\dot{m}^2 + \dot{m}_{cr}^2}}{2\rho_{Avg} C_d^2 S^2} \left[1 - \left(\frac{S_R}{S} \right)^2 \right] P_{R_{Loss}},$$

where:

- p_A and p_B are the pressures at port A and port B.
- \dot{m} is the mass flow rate.
- \dot{m}_{CR} is the critical mass flow rate.
- ρ_{Avg} is the average liquid density.
- C_d is the discharge coefficient.
- S_R is the valve opening area.
- S is the valve inlet area.
- PR_{Loss} is the pressure ratio:

$$PR_{Loss} = \frac{\sqrt{1 - (S_R/S)^2(1 - C_d^2)} - C_d(S_R/S)}{\sqrt{1 - (S_R/S)^2(1 - C_d^2)} + C_d(S_R/S)}$$

The valve opening area is computed as

$$S_R = \begin{cases} S_{Leak}, & p_{control} \leq p_{set} \\ S_{Leak}(1 - \lambda_L) + S_{Linear}\lambda_L, & p_{control} < p_{Min} + \Delta p_{smooth} \\ S_{Linear}, & p_{control} \leq p_{Max} - \Delta p_{smooth}, \\ S_{Linear}(1 - \lambda_R) + S_{Max}\lambda_R, & p_{control} < p_{Max} \\ S_{Max}, & p_{control} \geq p_{Max} \end{cases}$$

where:

- S_{Leak} is the valve leakage area.
- S_{Linear} is the linear valve opening area:

$$S_{Linear} = \left(\frac{S_{Max} - S_{Leak}}{p_{Max} - p_{set}} \right) (p_{control} - p_{set}) + S_{Leak}$$

- S_{Max} is the maximum valve opening area.
- $p_{control}$ is the valve control pressure:

$$p_{control} = \begin{cases} p_A, & \text{Pressure at port A} \\ p_A - p_B, & \text{Pressure differential} \end{cases}$$

- p_{set} is the valve set pressure:

$$p_{set} = \begin{cases} p_{set, gauge} + p_{Atm}, & \text{Pressure at port A} \\ p_{set, diff}, & \text{Pressure differential} \end{cases}$$

- p_{Min} is the minimum pressure.
- p_{Max} is the maximum pressure:

$$p_{max} = \begin{cases} p_{set, gauge} + p_{range} + p_{Atm}, & \text{Pressure at port A} \\ p_{set, diff} + p_{range}, & \text{Pressure differential} \end{cases}$$

- Δp is the portion of the pressure range to smooth.

- λ_L and λ_R are the cubic polynomial smoothing functions

$$\lambda_L = 3\bar{p}_L^2 - 2\bar{p}_L^3$$

and

$$\lambda_R = 3\bar{p}_R^2 - 2\bar{p}_R^3$$

where:

$$\bar{p}_L = \frac{p_{control} - p_{set}}{(p_{set} + \Delta p_{smooth}) - p_{set}}$$

and

$$\bar{p}_R = \frac{p_{control} - (p_{max} - \Delta p_{smooth})}{p_{max} - (p_{max} - \Delta p_{smooth})}$$

The critical mass flow rate is

$$\dot{m}_{cr} = Re_{cr} \mu_{Avg} \sqrt{\frac{\pi}{4} S_R}$$

Energy Balance

The energy conservation equation in the valve is

$$\phi_A + \phi_B = 0,$$

where:

- ϕ_A is the energy flow rate into the valve through port A.
- ϕ_B is the energy flow rate into the valve through port B.

Ports

- A — Thermal liquid conserving port representing valve inlet A
- B — Thermal liquid conserving port representing valve inlet B

Parameters

Parameters Tab

Pressure control specification

Specification method for the valve set pressure parameter. Options include Pressure at port A and Pressure differential.

Valve set pressure (gauge)

Minimum gauge pressure at port A required to open the valve. A pressure rise above the set pressure causes the valve to gradually open until it reaches the fully open state. This parameter is active only when the **Pressure control specification** parameter is set to Pressure at port A. The default value is 0.1 MPa.

Valve set pressure differential

Minimum pressure differential between ports A and B required to open the valve. A pressure differential rise above this value causes the valve to gradually open until it reaches the fully open state. This parameter is active only when the **Pressure control specification** parameter is set to Pressure differential. The default value is 0 MPa.

Pressure regulation range

Difference between the maximum and set pressures at port A. The valve begins to open at the set pressure. It is fully open at the maximum pressure. The default value is 0.01 MPa.

Maximum opening area

Area normal to the direction of flow at the point of narrowest aperture when the valve is fully open—that is, when the pressure drop from port A to port B reaches or exceeds the upper limit of the pressure regulation range.

This upper limit is calculated from other block parameters and these depend on the **Pressure control specification** setting:

- If Pressure at port A is chosen, the upper limit is the sum of the **Pressure regulation range** parameter, the **Valve set pressure (gauge)** parameter, and the atmospheric pressure specified for the Thermal Liquid network of which this block is a part.
- If Pressure differential is used instead, the upper limit is the sum of the **Pressure regulation range** and **Valve set pressure differential** parameters.

The default value is $1e-4$ MPa.

Leakage area

Aggregate area of all fluid leaks in the valve. The leakage area helps to prevent numerical issues due to isolated fluid network sections. For numerical robustness, set this parameter to a nonzero value. The default value is $1e-12$.

Smoothing factor

Fraction of the opening-area curve, expressed as a fraction from 0 to 1, to smooth. The block replaces the discontinuities in the opening area curve with smooth transitions that span the specified fraction of the curve. The default value is 0.01.

A smoothing factor of 0 corresponds to a linear function that is discontinuous at the set and maximum-area pressures. A smoothing factor of 1 corresponds to a nonlinear function that changes continuously throughout the entire function domain.

A smoothing factor between 0 and 1 corresponds to a continuous piece-wise function with smooth nonlinear transitions at the set and maximum-area pressures and linear segments elsewhere.

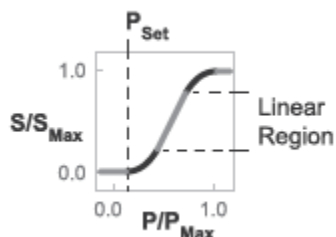

Opening-Area Curve Smoothing

Cross-sectional area at ports A and B

Flow area at the valve inlets. The inlets are assumed equal in size. The default value is 0.01 m^2 .

Characteristic longitudinal length

Approximate length of the valve. This parameter provides a measure of the longitudinal scale of the valve. The default value is 0.1 m .

Discharge coefficient

Semi-empirical parameter commonly used as a measure of valve performance. The discharge coefficient is defined as the ratio of the actual mass flow rate through the valve to its theoretical value.

The block uses this parameter to account for the effects of valve geometry on mass flow rates. Textbooks and valve data sheets are common sources of discharge coefficient values. By definition, all values must be greater than 0 and smaller than 1. The default value is 0.7 .

Critical Reynolds number

Reynolds number corresponding to the transition between laminar and turbulent flow regimes. The flow through the valve is assumed laminar below this value and turbulent above it. The appropriate values to use depend on the specific valve geometry. The default value is 12.

Variables Tab**Mass flow rate into port A**

Mass flow rate into the component through port **A** at the start of simulation. The default value is 1 kg/s .

Extended Capabilities**C/C++ Code Generation**

Generate C and C++ code using Simulink® Coder™.

See Also

Pressure Reducing Valve (TL)

Introduced in R2016a

Pressure Relief Valve (2P)

Pressure relief valve in a two-phase fluid network

Library: Simscape / Fluids / Two-Phase Fluid / Valves & Orifices / Pressure Control Valves



Description

The Pressure Relief Valve (2P) block models a pressure-controlling relief valve in a two-phase fluid network. The valve opens when the pressure exceeds the set pressure. Specify the pressure differential that opens the valve in the **Set pressure specification** parameter, which can be the pressure difference between ports **A** and **B** or the gauge pressure at port **A**. When you set **Set pressure control** to **Controlled**, the set pressure varies according to the input signal at port **Ps**.

Fluid properties inside the valve are calculated from inlet conditions. There is no heat exchange between the fluid and the environment, and therefore phase change inside the valve only occurs due to a pressure drop or a propagated phase change from another part of the model.

A number of block parameters are based on nominal operating conditions, which correspond to the valve rated performance, such as a specification on a manufacturer datasheet.

Pressure Control

The valve opens when the pressure in the valve, $p_{control}$, exceeds the **Set pressure differential**, p_{set} . The valve is fully open when the control pressure reaches the end of the **Pressure regulation range**, p_{range} .

When you set **Set pressure control** to **Constant**, the opening fraction of the valve, λ , is expressed as:

$$\lambda = (1 - f_{leak}) \frac{(p_{control} - p_{set})}{p_{range}} + f_{leak},$$

where:

- f_{leak} is the **Closed valve leakage as a fraction of nominal flow**.
- $p_{control}$ is the control pressure, which depends on the **Set pressure specification** parameter.

When you set **Set pressure specification** to **Pressure differential**, the control pressure is $P_A - P_B$.

When you set **Set pressure specification** to **Gauge pressure at port A**, the control pressure is the difference between the pressure at port **A** and atmospheric pressure.

When you set **Set pressure control** to **Controlled**, the valve opening fraction is:

$$\lambda = (1 - f_{leak}) \frac{(p_{control} - p_s)}{p_{range}} + f_{leak},$$

where p_s is the signal at port **Ps**. If the control pressure exceeds the valve pressure regulation range, the valve opening fraction is 1.

Mass Flow Rate

The mass flow rate depends on the pressure differential, and therefore the open area of the valve. It is calculated as:

$$\dot{m}_A = \lambda \dot{m}_{nom} \left[\sqrt{\frac{v_{nom}}{2\Delta p_{nom}}} \right] \sqrt{\frac{2}{v_{in} (\Delta p^2 + \Delta p_{lam}^2)^{0.25}}}$$

where:

- Δp is the pressure drop over the valve, $p_A - p_B$.
- Δp_{lam} is the pressure transition threshold between laminar and turbulent flow, which is calculated from the **Laminar flow pressure ratio**, B_{lam} :

$$\Delta p_{lam} = \frac{(p_A + p_B)}{2} (1 - B_{lam}).$$

- \dot{m}_{nom} is the **Nominal mass flow rate at maximum opening**.
- Δp_{nom} is the **Nominal pressure drop rate at maximum opening**.
- v_{nom} is the nominal inlet specific volume. This value is determined from the fluid properties tabulated data based on the **Nominal inlet specific enthalpy** and **Nominal inlet pressure** parameters.
- v_{in} is the inlet specific volume.

Fluid Specific Volume Dynamics

When the fluid at the valve inlet is a liquid-vapor mixture, the block calculates the specific volume as:

$$v_{in} = (1 - x_{dyn})v_{liq} + x_{dyn}v_{vap}$$

where:

- x_{dyn} is the inlet vapor quality. The block applies a first-order lag to the inlet vapor quality of the mixture.
- v_{liq} is the liquid specific volume of the fluid.
- v_{vap} is the vapor specific volume of the fluid.

If the inlet fluid is liquid or vapor, v_{in} is the respective liquid or vapor specific volume.

Vapor Quality Lag

If the inlet vapor quality is a liquid-vapor mixture, a first-order time lag is applied:

$$\frac{dx_{dyn}}{dt} = \frac{x_{in} - x_{dyn}}{\tau},$$

where:

- x_{dyn} is the dynamic vapor quality.
- x_{in} is the current inlet vapor quality.

- τ is the **Inlet phase change time constant**.

If the inlet fluid is a subcooled liquid or superheated vapor, x_{dyn} is equal to x_{in} .

Mass Balance

Mass is conserved in the valve:

$$\dot{m}_A + \dot{m}_B = 0,$$

where:

- \dot{m}_A is the mass flow rate at port **A**.
- \dot{m}_B is the mass flow rate at port **B**.

Energy Balance

Energy is conserved in the valve:

$$\Phi_A + \Phi_B = 0,$$

where:

- Φ_A is the energy flow at port **A**.
- Φ_B is the energy flow at port **B**.

Assumptions and Limitations

- The block does not model pressure recovery downstream of the valve.
- There is no heat exchange between the valve and the environment.
- The block does not model choked flow.

Ports

Conserving

A — Fluid port

two-phase fluid

Fluid entry or exit port.

B — Fluid port

two-phase fluid

Fluid entry or exit port.

Input

Ps — Set pressure

physical signal

Input port for varying set pressure signal.

Dependencies

To enable this port, set **Set pressure control** to **Controlled**.

Parameters**Set pressure control – Variable or constant set pressure**

Constant (default) | Controlled

Whether the pressure threshold is constant or variable. Setting this parameter to **Controlled** exposes the physical signal port **Ps**.

Set pressure specification – Control pressure

Pressure differential (default) | Gauge pressure at port A

Control pressure specification:

- When set to **Pressure differential**, the valve opens when $p_A - p_B$ exceeds the **Set pressure differential**.
- When set to **Gauge pressure at port A**, the valve opens when $p_A - p_{atm}$ exceeds the **Set pressure (gauge)**.

Set pressure differential – Set pressure

0.01 MPa (default) | positive scalar

Valve pressure threshold. When the control pressure, $p_A - p_B$, exceeds the set pressure, the valve begins to open.

Dependencies

To enable this parameter, set **Set pressure control** to **Constant** and **Set pressure specification** to **Pressure differential**.

Set pressure (gauge) – Set pressure

0.1 MPa (default) | positive scalar

Valve pressure threshold. When the control pressure, $p_A - p_{atm}$, exceeds the set pressure, the valve begins to open.

Dependencies

To enable this parameter, set **Set pressure control** to **Constant** and **Set pressure specification** to **Gauge pressure at port A**.

Pressure regulation range – Valve operational range

0.1 MPa (default) | positive scalar

Valve operational range. The valve begins to open at the set pressure value, and is fully open at p_{max} , the end of the pressure regulation range: $p_{max} = p_{set} + p_{range}$.

Nominal mass flow rate at maximum opening – Rated mass flow rate

0.1 kg/s (default) | positive scalar

Mass flow rate through a fully open valve under typical, design, or rated conditions.

Nominal pressure drop at maximum opening — Rated pressure drop

0.001 MPa (default) | positive scalar

Pressure drop over a fully open valve under typical, design, or rated conditions.

Nominal inlet condition specification — Method of determining inlet fluid state

Temperature (default) | Vapor quality | Vapor void fraction | Specific enthalpy | Specific internal energy

Method of determining inlet fluid state. The valve inlet specific volume is determined from the fluid properties tabulated data based on the **Nominal inlet pressure** and the setting of the **Nominal inlet condition specification** parameters.

Nominal inlet pressure — Pressure of fluid entering valve

0.101325 MPa (default) | positive scalar

Inlet pressure to the valve in typical, design, or rated conditions. The valve inlet specific volume is determined from the fluid properties tabulated data based on the **Nominal inlet pressure** and the setting of the **Nominal inlet condition specification** parameters.

Nominal inlet temperature — Fluid temperature

293.15 K (default) | positive scalar

Inlet fluid temperature in nominal operating conditions.

Dependencies

To enable this parameter, set **Nominal inlet condition specification** to Temperature.

Nominal inlet vapor quality — Inlet vapor quality by mass fraction

0.5 (default) | positive scalar in the range [0,1]

Inlet vapor quality of the mixture by mass fraction in nominal operating conditions. A value of 0 means that the inlet fluid is subcooled liquid. A value of 1 means that the inlet fluid is superheated vapor.

Dependencies

To enable this parameter, set **Nominal inlet condition specification** to Vapor quality.

Nominal inlet vapor void fraction — Inlet volume fraction

0.5 (default) | positive scalar in the range [0,1]

Inlet mixture by volume fraction in nominal operating conditions. A value of 0 means that the inlet fluid is subcooled liquid. A value of 1 means that the inlet fluid is superheated vapor.

Dependencies

To enable this parameter, set **Nominal inlet condition specification** to Vapor void fraction.

Nominal inlet specific enthalpy — Inlet fluid specific enthalpy

1500 kJ/kg (default) | positive scalar

Inlet specific enthalpy in nominal operating conditions.

Dependencies

To enable this parameter, set **Nominal inlet condition specification** to Specific enthalpy.

Nominal inlet specific internal energy — Inlet specific internal energy

1500 kJ/kg (default) | positive scalar

Inlet specific internal energy in nominal operating conditions.

Dependencies

To enable this parameter, set **Nominal inlet condition specification** to Specific internal energy.

Cross-sectional area at ports A and B — Valve port areas0.01 m² (default) | positive scalar

Area of the valve ports **A** and **B**.

Closed valve leakage as a fraction of nominal flow — Fractional flow when valve is closed

1e-6 (default) | positive scalar

Fractional flow rate through the valve when it is fully closed. This parameter contributes to numerical stability by maintaining continuity in the fluid network.

Smoothing factor — Numerical smoothing factor

0.01 (default) | positive scalar in the range [0,1]

Continuous smoothing factor that introduces a layer of gradual change to the flow response when the valve is in near-open or near-closed positions. Set this parameter to a nonzero value less than one to increase the stability of your simulation in these regimes.

Laminar flow pressure ratio — Laminar-turbulent transition pressure ratio

0.999 (default) | positive scalar

Ratio of the valve outlet pressure to valve inlet pressure at which the fluid transitions between the laminar and turbulent regimes. The pressure loss corresponds to the mass flow rate linearly in laminar flows and quadratically in turbulent flows.

Inlet phase change time constant — Lag for mixture specific volume

0.1 s (default) | positive scalar

Time lag for liquid-vapor mixtures in computing the fluid specific volume. This parameter does not influence the specific volume when the inlet fluid is a fully supercooled liquid or fully superheated vapor.

See Also

Pressure-Reducing Valve (2P) | Check Valve (2P) | Orifice (2P) | Thermostatic Expansion Valve (2P)

Introduced in R2021a

Proportional and Servo-Valve Actuator

Continuous valve driver with output proportional to input signal



Library

Valve Actuators

Description

The Proportional and Servo-Valve Actuator block represents an electromagnetic actuator that is used in proportional and servo-valves to drive a spool or other working member. The block is intended to work with one of the directional valve models to form a desirable configuration of a proportional or servo-valve. The block is implemented as a data-sheet-based model and reproduces only the input/output relationship, or the actuator's transient response, as presented in the catalog or data sheet.

The Proportional and Servo-Valve Actuator block is built using the blocks from the Simscape Physical Signals library. Both the input and the output of the block are physical signals. The block diagram of the model is shown in the following figure.

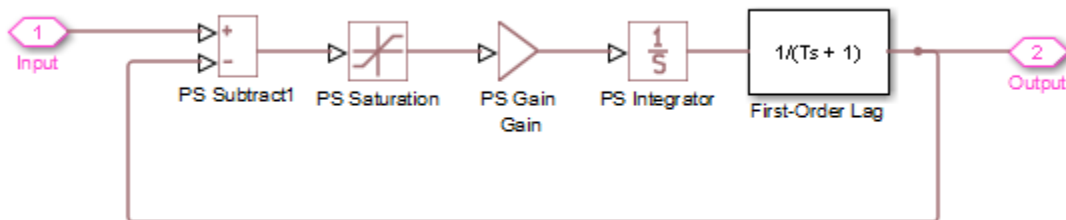

The model of the actuator is built of the Foundation Library Physical Signals blocks: PS Subtract, PS Saturation, PS Gain, PS Integrator. The first-order lag is arranged as a subsystem, as shown below,

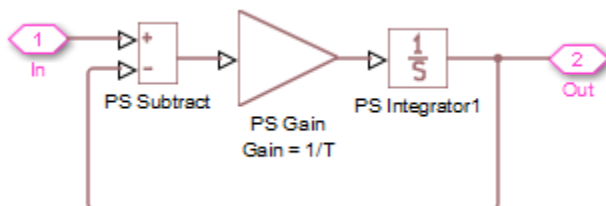

and is also built of the Physical Signals blocks: PS Subtract, PS Gain, and PS Integrator. The transfer function of the lag is

$$H(s) = \frac{1}{Ts + 1}$$

where T is the **Time constant** of the lag. The value of this parameter is set through the parameter **Gain** of the PS Gain block in the First-Order Lag subsystem by setting it equal to $1/T$.

The typical transient responses of a servo-valve or a high-quality proportional valve are shown in the following figure. The only difference between the two responses in the figure is the value of the saturation.

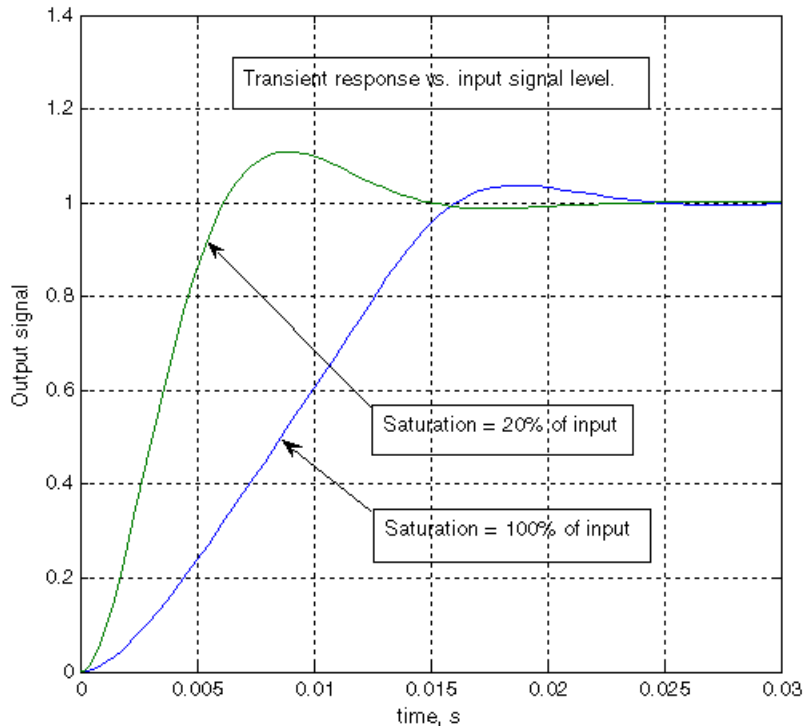

You can adjust the block parameters, such as saturation, gain, and time constant, to make the transient responses close enough to those provided in the data sheet. The most effective way to adjust the parameters is to use the Simulink Design Optimization software.

Note This block is constructed out of blocks from the Simscape Physical Signals library (such as PS Add, PS Gain, and so on). Currently, the blocks in the Physical Signals library do not support unit propagation and checking. For more information, see “How to Work with Physical Units”.

Parameters

Gain

Gain of the PS Gain block in the top level of the block diagram of the actuator model. The default value is 377.

Time constant

Time constant of the first-order lag. The **Gain** parameter of the PS Gain block in the First-Order Lag subsystem is equal to $1/\text{Time constant}$. The default value is 0.002 s.

Saturation

Saturation level of the PS Saturation block in the actuator model. The default value is 0.3.

Ports

The block has one physical signal input port and one physical signal output port.

Examples

The “Closed-Loop Actuator with Variable-Displacement Pressure-Compensated Pump” example illustrates the use of the Proportional and Servo-Valve Actuator block in hydraulic systems.

Extended Capabilities

C/C++ Code Generation

Generate C and C++ code using Simulink® Coder™.

See Also

2-Position Valve Actuator | 3-Position Valve Actuator | Hydraulic Double-Acting Valve Actuator | Hydraulic Single-Acting Valve Actuator

Introduced in R2006a

Proportional Valve Actuator

Models a power-controlled valve actuator in an isothermal liquid system

Library: Simscape / Fluids / Isothermal Liquid / Valves / Valve Actuators



Description

The Proportional Valve Actuator block models a power-controlled actuator used in conjunction with a valve block in an isothermal network. The signal to open or close the valve is received at port **A**. The opening distance for a connected valve is returned as a physical signal at port **S**.

You can adjust the opening or closing magnitude with the **Actuator gain** parameter. A first-order lag in time is applied to the actuation distance:

$$\frac{(IG - d)}{\tau},$$

where:

- IG is the signal received at port **A** multiplied by the **Actuator gain**. Outside of the valve stroke limits, IG is the **Valve stroke** if fully extended and the negative **Valve stroke** if fully retracted.
- d is the current actuator position.
- τ is the **Time constant**.

Note This reference page is for the Isothermal Liquid library block. For the Hydraulics (Isothermal) Liquid library block, see Proportional and Servo-Valve Actuator.

Variables

Use the **Variables** tab to set the priority and initial target values for the block variables prior to simulation. For more information, see “Set Priority and Initial Target for Block Variables”.

Ports

Input

A — Valve opening signal

physical signal

Physical signal that indicates valve opening or closing, specified as a physical signal. The signal is multiplied by the **Actuator gain** value.

Output

S — Valve opening distance, in m

physical signal

Opening distance for the connected valve, specified as a physical signal in m.

Parameters

Actuator gain — Input signal multiplier

5e-4 m (default) | positive scalar

Input signal multiplier for the valve opening distance.

Time constant — Opening signal time constant

0.01 s (default) | positive scalar

Constant that captures the time required to reach steady-state conditions during actuation. This parameter impacts the response lag to the valve opening or closing signal.

Valve stroke — Maximum valve opening distance

0.005 m (default) | positive scalar

Maximum opening distance of the connected valve.

Extended Capabilities

C/C++ Code Generation

Generate C and C++ code using Simulink® Coder™.

See Also

Multiposition Valve Actuator | Pilot Valve Actuator (IL) | Cartridge Valve Actuator (IL)

Introduced in R2020a

Receiver Accumulator (2P)

Tank with liquid and vapor volumes of variable proportion

Library: Simscape / Fluids / Two-Phase Fluid / Tanks & Accumulators

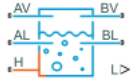

Description

The Receiver-Accumulator (2P) block represents a tank with fluid that can undergo phase change. The liquid and vapor phases, referred to as *zones*, are modeled as distinct volumes that can change in size during simulation, but do not mix. The relative amount of space a zone occupies in the system is called a *zone fraction*, which ranges from 0 to 1. The vapor-liquid mixture phase is not modeled.

In an HVAC system, when this tank is placed between a condenser and an expansion valve, it acts as a receiver. Liquid connections to the block are made at ports **AL** and **BL**. When the tank is placed between an evaporator and a compressor, it acts as an accumulator. Vapor connections to the block are made at ports **AV** and **BV**. A fluid of either phase can be connected to either port, however the fluid exiting from a V port is in the vapor zone and an L port is in the liquid zone. There is no mass flow through unconnected ports.

The temperature of the tank walls are set at port **H**.

The liquid level of the tank is reported as a zone fraction at port **L**. If the liquid level reports 0, the tank is fully filled with vapor. The tank is never empty.

Heat Transfer Between the Fluid and Wall

The total heat transfer between the fluid and the wall, Q_H , is the sum of the heat transfer in the liquid and vapor phases:

$$Q_H = Q_L + Q_V.$$

The heat transfer between the liquid and the wall is:

$$Q_L = z_L S_W \alpha_L (T_H - T_L),$$

where:

- z_L is the liquid volume fraction of the tank.
- S_W is the **Total heat transfer surface area**.
- α_L is the **Liquid heat transfer coefficient**.
- T_H is the temperature of the tank wall.
- T_L is the temperature of the liquid.

The heat transfer between the vapor and the wall is:

$$Q_V = (1 - z_L) S_W \alpha_V (T_H - T_V),$$

where:

- α_V is the **Vapor heat transfer coefficient**.
- T_V is the temperature of the vapor.

The liquid volume fraction is determined from the liquid mass fraction:

$$z_L = \frac{f_{M,L}\nu_L}{f_{M,L}\nu_L + (1 - f_{M,L})\nu_V}$$

where:

- $f_{M,L}$ is the mass fraction of the liquid.
- ν_L is the specific volume of the liquid.
- ν_V is the specific volume of the vapor.

Energy Flow Rates Due To Phase Change

When the liquid specific enthalpy is greater than or equal to the saturated liquid specific enthalpy, the mass flow rate of the vaporizing fluid is:

$$\dot{m}_{Vap} = \frac{M_L(h_L - h_{L,Sat})/(h_V - h_{L,Sat})}{\tau}$$

where:

- M_L is the total liquid mass.
- τ is the **Vaporization and condensation time constant** parameter.
- h_L is the specific enthalpy of the liquid at the internal node.
- $h_{L,Sat}$ is the saturated liquid specific enthalpy at the internal node.
- h_V is the specific enthalpy of the vapor.
- $h_{V,Sat}$ is the saturated vapor specific enthalpy.

The energy flow associated with vaporization is:

$$\phi_{Vap} = \dot{m}_{Vap}h_{V,Sat}$$

When the liquid specific enthalpy is lower than the saturated liquid specific enthalpy, no vaporization occurs, and $\dot{m}_{Vap} = 0$.

Similarly, when the vapor specific enthalpy is less than or equal to the saturated vapor specific enthalpy, the mass flow rate of the condensing fluid is:

$$\dot{m}_{Con} = \frac{M_V(h_V - h_{V,Sat})/(h_V - h_{L,Sat})}{\tau}$$

where M_V is the total vapor mass.

The energy flow associated with condensation is:

$$\phi_{Con} = \dot{m}_{Con}h_{L,Sat}$$

When the vapor specific enthalpy is higher than the saturated vapor specific enthalpy, no condensation occurs, and $\dot{m}_{Con} = 0$.

Mass Balance

The total tank volume is constant. Due to phase change, the volume fraction and mass of the fluid changes. The mass balance in the liquid zone is:

$$\frac{dM_L}{dt} = \dot{m}_{L,In} - \dot{m}_{L,Out} + \dot{m}_{Con} - \dot{m}_{Vap},$$

where:

- $\dot{m}_{L,In}$ is the inlet liquid mass flow rate at all L and V ports.
- $\dot{m}_{L,Out}$ is the outlet liquid mass flow rate:

$$\dot{m}_{L,Out} = -(\dot{m}_{AL} + \dot{m}_{BL}),$$

- \dot{m}_{Con} is the mass flow rate of the condensing fluid.
- \dot{m}_{Vap} is the mass flow rate of the vaporizing fluid.

The mass balance in the vapor zone is:

$$\frac{dM_V}{dt} = \dot{m}_{V,In} - \dot{m}_{V,Out} - \dot{m}_{Con} + \dot{m}_{Vap},$$

where:

- M_V is the total vapor mass.
- $\dot{m}_{V,In}$ is the inlet vapor mass flow rate at all L and V ports.
- $\dot{m}_{V,Out}$ is the outlet vapor mass flow rate:

$$\dot{m}_{V,Out} = -(\dot{m}_{AV} + \dot{m}_{BV}).$$

If there is only one zone present in the tank, the outlet mass flow rate of the fluid is the sum of the flow rate through all of the ports:

$$\dot{m}_{phase,Out} = -(\dot{m}_{AL} + \dot{m}_{BL} + \dot{m}_{AV} + \dot{m}_{BV}).$$

where $\dot{m}_{phase,Out}$ is $\dot{m}_{L,Out}$ if the fluid is entirely liquid, and $\dot{m}_{V,Out}$ if the fluid is entirely vapor.

Energy Balance

The fluid can heat or cool depending on the heat transfer between the tank and wall, which is set by the temperature at port **H**.

The energy balance in the liquid zone is:

$$M_L \frac{du_L}{dt} + \frac{dM_L}{dt} u_L = \phi_{L,In} - \phi_{L,Out} + \phi_{Con} - \phi_{Vap} + Q_L.$$

where:

- u_L is the specific internal energy of the liquid.
- $\phi_{L,In}$ is the inlet liquid energy flow rate at all L and V ports.
- $\phi_{L,Out}$ is the outlet liquid energy flow rate:

$$\phi_{L,Out} = -(\phi_{AL} + \phi_{BL}).$$

- ϕ_{Con} is the energy flow rate of the condensing vapor.
- ϕ_{Vap} is the energy flow rate of the vaporizing liquid.
- Q_L is the heat transfer between the tank wall and the liquid.

The energy balance in the vapor zone is:

$$M_V \frac{du_V}{dt} + \frac{dM_V}{dt} u_V = \phi_{V,In} - \phi_{V,Out} - \phi_{Con} + \phi_{Vap} + Q_V.$$

- u_V is the specific internal energy of the vapor.
- $\phi_{V,In}$ is the inlet vapor energy flow rate at all L and V ports.
- $\phi_{V,Out}$ is the outlet vapor energy flow rate:

$$\phi_{V,Out} = -(\phi_{AV} + \phi_{BV}).$$

- Q_V is the heat transfer between the tank wall and the vapor.

If there is only one zone present in the tank, the outlet energy flow rate is the sum of the flow rate through all of the ports:

$$\phi_{phase,Out} = -(\phi_{AL} + \phi_{BL} + \phi_{AV} + \phi_{BV}).$$

where $\phi_{phase,Out}$ is $\phi_{L,Out}$ if the fluid is entirely liquid, and $\phi_{V,Out}$ if the fluid is entirely vapor.

Momentum Balance

There are no pressure changes modeled in the tank, including hydrostatic pressure. The pressure at any port is equal to the internal tank pressure.

Assumptions and Limitations

- Pressure must remain below the critical pressure.
- Hydrostatic pressure is not modeled.
- The container wall is rigid, therefore the total volume of fluid is constant.
- The thermal mass of the tank wall is not modeled.
- Flow resistance through the outlets is not modeled. To model pressure losses associated with the outlets, connect a Local Restriction (2P) block or a Flow Resistance (2P) block to the ports of the Receiver-Accumulator (2P) block.
- A liquid-vapor mixture is not modeled.

Ports

Output

L – Liquid level

physical signal

Liquid level in the tank. Use this port to monitor the amount of liquid remaining inside.

Conserving

AV – Tank opening

two-phase fluid

Opening for the fluid to flow into or out of the tank. Both liquid and vapor can enter through this port. However, only vapor can exit through it—until the tank is depleted of vapor, in which event liquid too can flow out through this port.

BV — Tank opening

two-phase fluid

Opening for the fluid to flow into or out of the tank. Both liquid and vapor can enter through this port. However, only vapor can exit through it—until the tank is depleted of vapor, in which event liquid too can flow out through this port.

AL — Tank opening

two-phase fluid

Opening for the fluid to flow into or out of the tank. Both liquid and vapor can enter through this port. However, only liquid can exit through it—until the tank is depleted of liquid, in which event vapor too can flow out through this port.

BL — Tank opening

two-phase fluid

Opening for the fluid to flow into or out of the tank. Both liquid and vapor can enter through this port. However, only liquid can exit through it—until the tank is depleted of liquid, in which event vapor too can flow out through this port.

H — Tank wall

thermal

Thermal boundary between the fluid volume and the tank wall. Use this port to capture heat exchanges of various kinds—for example, conductive, convective, or radiative—between the fluid and the environment external to the tank.

Parameters

Main

Total volume — Aggregate volume of liquid and vapor phases in the tank

1 m³ (default) | positive scalar with units of volume

Aggregate volume of liquid and vapor phases in the tank.

Cross-sectional area at port AV — Area normal to the direction of flow at port AV

0.01 m² (default) | positive scalar with units of area

Area normal to the direction of flow at port **AV**.

Cross-sectional area at port BV — Area normal to the direction of flow at port BV

0.01 m² (default) | positive scalar with units of area

Area normal to the direction of flow at port **BV**.

Cross-sectional area at port AL — Area normal to the direction of flow at port AL

0.01 m² (default) | positive scalar with units of area

Area normal to the direction of flow at port **AL**.

Cross-sectional area at port BL — Area normal to the direction of flow at port BL

0.01 m² (default) | positive scalar with units of area

Area normal to the direction of flow at port **BL**.

Liquid volume fraction out of range — Means by which to handle extreme volume fractions

No error (default) | Error | Warning

Means by which to handle unusual volume fractions. Select Warning to be notified when the volume fraction crosses a specified range. Select Error to stop simulation at such events.

Minimum liquid volume fraction — Value below which to trigger warning or error

0.05 (default) | positive scalar between 0 and 1

Lower bound of the valid range for the liquid volume fraction in the tank. Fractions below this value will trigger a simulation warning or error (depending on the setting of the **Liquid volume fraction out of range** block parameter).

Dependencies

This parameter is active when the **Liquid volume fraction out of range** block parameter is set to Warning or Error.

Maximum liquid volume fraction — Value above which to trigger warning or error

0.95 (default) | positive scalar between 0 and 1

Upper bound of the valid range for the liquid volume fraction in the tank. Fractions above this value will trigger a simulation warning or error (depending on the setting of the **Liquid volume fraction out of range** block parameter).

Dependencies

This parameter is active when the **Liquid volume fraction out of range** block parameter is set to Warning or Error.

Volume fraction threshold for transition to pure liquid or pure vapor — Volume fraction of a phase below which to transition to a single-phase tank

20 W/(m²*K) (default) | positive scalar with units of power/(area*temperature)

Volume fraction of either phase below which to transition to a single-phase tank—either subcooled liquid or superheated vapor. This parameter determines how smooth the transition is. The larger its value, the smoother the transition and therefore the faster the simulation (though at the cost of lower accuracy).

Heat Transfer**Vapor heat transfer coefficient — Coefficient for heat exchange between vapor and the tank wall**

20 W/(m²*K) (default) | positive scalar with units of power/(area*temperature)

Coefficient for heat exchange between the vapor zone and its section of the tank wall. This parameter serves to calculate the rate of this heat exchange.

Liquid heat transfer coefficient – Coefficient for heat exchange between liquid and the tank wall100 W/(m²*K) (default) | positive scalar with units of power/(area*temperature)

Coefficient for heat exchange between the liquid zone and its section of the tank wall. This parameter serves to calculate the rate of this heat exchange.

Total heat transfer surface area – Wall surface area in contact with fluid6 m² (default) | positive scalar with units of area

Surface area of the tank through which heat exchange with the fluid occurs.

Effects and Initial Conditions Tab**Initial fluid energy specification – Thermodynamic variable whose initial value to set**

Liquid volume fraction (default) | Temperature | Liquid mass fraction | Specific enthalpy | Specific internal energy

Thermodynamic variable in terms of which to define the initial conditions of the component.

Initial pressure – Absolute pressure at the start of simulation

0.101325 MPa (default) | scalar with units of pressure

Pressure in the tank at the start of simulation, specified against absolute zero.

Initial temperature – Absolute temperature at the start of simulation

293.15 K (default) | scalar with units of temperature

Temperature in the tank at the start of simulation, specified against absolute zero.

Dependencies

This parameter is active when the **Initial fluid energy specification** option is set to Temperature.

Initial liquid mass fraction – Mass fraction of liquid at the start of simulation

0.5 (default) | unitless scalar between 0 and 1

Mass fraction of liquid in the tank at the start of simulation.

Dependencies

This parameter is active when the **Initial fluid energy specification** option is set to Liquid mass fraction.

Initial liquid volume fraction – Volume fraction of liquid at the start of simulation

0.5 (default) | unitless scalar between 0 and 1

Volume fraction of liquid in the tank at the start of simulation.

Dependencies

This parameter is active when the **Initial fluid energy specification** option is set to Liquid volume fraction.

Initial specific enthalpy – Specific enthalpy at the start of simulation

1500 kJ/kg (default) | scalar with units of energy/mass

Specific enthalpy of the fluid in the tank at the start of simulation.

Dependencies

This parameter is active when the **Initial fluid energy specification** option is set to Specific enthalpy.

Initial specific internal energy — Specific internal energy at the start of simulation

1500 kJ/kg (default) | scalar with units of energy/mass

Specific internal energy of the fluid in the tank at the start of simulation.

Dependencies

This parameter is active when the **Initial fluid energy specification** option is set to Specific internal energy.

Vaporization and condensation time constant — Characteristic duration of a phase-change event

0.1 s (default) | scalar with units of time

Characteristic time to equilibrium of a phase-change event taking place in the tank. Increase this parameter to slow the rate of phase change or decrease it to speed up the rate.

Extended Capabilities**C/C++ Code Generation**

Generate C and C++ code using Simulink® Coder™.

See Also

3-Zone Pipe (2P) | Constant Volume Chamber (2P) | 2-Port Constant Volume Chamber (2P) | 3-Port Constant Volume Chamber (2P)

Introduced in R2018b

Reservoir

Pressurized hydraulic reservoir

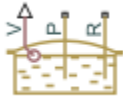

Library

Hydraulic Utilities

Description

The Reservoir block represents a pressurized hydraulic reservoir, in which fluid is stored under a specified pressure. The pressure remains constant regardless of volume change. The block accounts for pressure loss in the return line that can be caused by a filter, fittings, or some other local resistance. The loss is specified with the pressure loss coefficient. The block computes the volume of fluid in the tank and exports it outside through the physical signal port V.

The fluid volume value does not affect the results of simulation. It is introduced merely for information purposes. It is possible for the fluid volume to become negative during simulation, which signals that the fluid volume is not enough for the proper operation of the system. By viewing the results of the simulation, you can determine the extent of the fluid shortage.

Parameters

Pressurization level

The pressure inside the reservoir. The default value is 0.

Initial fluid volume

The initial volume of fluid in the tank. The default value is 0.02 m³.

Return line diameter

The diameter of the return line. The default value is 0.02 m.

Pressure loss coefficient in return line

The value of the pressure loss coefficient, to account for pressure loss in the return line. This parameter must be greater than zero. The default value is 1.

For reasons of computational robustness, the loss is computed with the equation similar to that used in the Fixed Orifice block:

$$q = \frac{1}{\sqrt{K}} A_p \sqrt{\frac{2}{\rho} p_{loss}}$$

The Critical Reynolds number is set to 15.

Ports

The block has the following ports:

P

Hydraulic conserving port associated with the pump line.

R

Hydraulic conserving port associated with the return line.

V

Physical signal port that outputs the volume of fluid in the tank.

Extended Capabilities

C/C++ Code Generation

Generate C and C++ code using Simulink® Coder™.

See Also

[Constant Head Tank](#) | [Hydraulic Reference](#) | [Tank](#)

Topics

[“Upgrading Simscape Fluids Models Containing Hydraulics \(Isothermal\) Blocks”](#)

Introduced in R2006b

Resistive Pipe LP

Hydraulic pipeline which accounts for friction losses and port elevations



Library

Low-Pressure Blocks

Description

The Resistive Pipe LP block models hydraulic pipelines with circular and noncircular cross sections and accounts for resistive property only. In other words, the block is developed with the basic assumption of the steady state fluid momentum conditions. Neither fluid compressibility nor fluid inertia is considered in the model, meaning that features such as water hammer cannot be investigated. If necessary, you can add fluid compressibility, fluid inertia, and other effects to your model using other blocks, thus producing a more comprehensive model.

The end effects are also not considered, assuming that the flow is fully developed along the entire pipe length. To account for local resistances, such as bends, fittings, inlet and outlet losses, and so on, convert the resistances into their equivalent lengths, and then sum up all the resistances to obtain their aggregate length. Then add this length to the pipe geometrical length.

Pressure loss due to friction is computed with the Darcy equation, in which losses are proportional to the flow regime-dependable friction factor and the square of the flow rate. The friction factor in turbulent regime is determined with the Haaland approximation (see [1] on page 1-1386). The friction factor during transition from laminar to turbulent regimes is determined with the linear interpolation between extreme points of the regimes. As a result of these assumptions, the tube is simulated according to the following equations:

$$p = f \frac{(L + L_{eq})}{D_H} \frac{\rho}{2A^2} q \cdot |q| + \rho \cdot g(z_B - z_A)$$

$$f = \begin{cases} K_S/Re & \text{for } Re < = Re_L \\ f_L + \frac{f_T - f_L}{Re_T - Re_L}(Re - Re_L) & \text{for } Re_L < Re < Re_T \\ \frac{1}{\left(-1.8 \log_{10} \left(\frac{6.9}{Re} + \left(\frac{r/D_H}{3.7} \right)^{1.11} \right)\right)^2} & \text{for } Re > = Re_T \end{cases}$$

$$Re = \frac{q \cdot D_H}{A \cdot \nu}$$

where

p	Pressure loss along the pipe due to friction
q	Flow rate through the pipe
Re	Reynolds number
Re_L	Maximum Reynolds number at laminar flow
Re_T	Minimum Reynolds number at turbulent flow
K_s	Shape factor that characterizes the pipe cross section
f_L	Friction factor at laminar border
f_T	Friction factor at turbulent border
A	Pipe cross-sectional area
D_H	Pipe hydraulic diameter
L	Pipe geometrical length
L_{eq}	Aggregate equivalent length of local resistances
r	Height of the roughness on the pipe internal surface
ν	Fluid kinematic viscosity
z_A, z_B	Elevations of the pipe port A and port B, respectively
g	Gravity acceleration

The block positive direction is from port A to port B. This means that the flow rate is positive if it flows from A to B, and the pressure loss is determined as $p = p_A - p_B$.

Basic Assumptions and Limitations

- Flow is assumed to be fully developed along the pipe length.
- Fluid inertia, fluid compressibility, and wall compliance are not taken into account.

Parameters

- “Basic Parameters Tab” on page 1-1384
- “Vertical Position Tab” on page 1-1385
- “Variables Tab” on page 1-1385

Basic Parameters Tab

Pipe cross section type

The type of pipe cross section: **Circular** or **Noncircular**. For a circular pipe, you specify its internal diameter. For a noncircular pipe, you specify its hydraulic diameter and pipe cross-sectional area. The default value of the parameter is **Circular**.

Internal diameter

Pipe internal diameter. The parameter is used if **Pipe cross section type** is set to **Circular**. The default value is 0.01 m.

Noncircular pipe cross-sectional area

Pipe cross-sectional area. The parameter is used if **Pipe cross section type** is set to **Noncircular**. The default value is $1e-4 \text{ m}^2$.

Noncircular pipe hydraulic diameter

Hydraulic diameter of the pipe cross section. The parameter is used if **Pipe cross section type** is set to Noncircular. The default value is 0.0112 m.

Geometrical shape factor

Used for computing friction factor at laminar flow. The shape of the pipe cross section determines the value. For a pipe with a noncircular cross section, set the factor to an appropriate value, for example, 56 for a square, 96 for concentric annulus, 62 for rectangle (2:1), and so on [1 on page 1-1386]. The default value is 64, which corresponds to a pipe with a circular cross section.

Pipe length

Pipe geometrical length. The default value is 5 m.

Aggregate equivalent length of local resistances

This parameter represents total equivalent length of all local resistances associated with the pipe. You can account for the pressure loss caused by local resistances, such as bends, fittings, armature, inlet/outlet losses, and so on, by adding to the pipe geometrical length an aggregate equivalent length of all the local resistances. The default value is 1 m.

Internal surface roughness height

Roughness height on the pipe internal surface. The parameter is typically provided in data sheets or manufacturer's catalogs. The default value is $1.5e-5$ m, which corresponds to drawn tubing.

Laminar flow upper margin

Specifies the Reynolds number at which the laminar flow regime is assumed to start converting into turbulent. Mathematically, this is the maximum Reynolds number at fully developed laminar flow. The default value is 2000.

Turbulent flow lower margin

Specifies the Reynolds number at which the turbulent flow regime is assumed to be fully developed. Mathematically, this is the minimum Reynolds number at turbulent flow. The default value is 4000.

Vertical Position Tab**Port A elevation wrt reference plane**

The parameter specifies vertical position of the pipe port A with respect to the reference plane. The default value is 0.

Port B elevation wrt reference plane

The parameter specifies vertical position of the pipe port B with respect to the reference plane. The default value is 0.

Gravitational acceleration

Value of the gravitational acceleration constant (g). The block uses this parameter to compute the effects of an elevation gradient between the ports on their pressure differential. The default value is 9.80655 m/s^2 .

Variables Tab**Pressure drop from port A to port B**

Value at time zero of the pressure drop between the ports. Simscape software uses this parameter to guide the initial configuration of this component and of the model. Initial variables that conflict with each other or that are incompatible with the model may be ignored. Set the **Priority** column to High to prioritize this variable over other, lower-priority, variables.

Flow rate from port A to port B

Value at time zero of the flow rate through the ports. Simscape software uses this parameter to guide the initial configuration of this component and of the model. Initial variables that conflict with each other or that are incompatible with the model may be ignored. Set the **Priority** column to High to prioritize this variable over other, lower-priority, variables.

Restricted Parameters

When your model is in Restricted editing mode, you cannot modify the following parameter:

- **Pipe cross section type**

All other block parameters are available for modification. The actual set of modifiable block parameters depends on the value of the **Pipe cross section type** parameter at the time the model entered Restricted mode.

Global Parameters

Parameters determined by the type of working fluid:

- **Fluid density**
- **Fluid kinematic viscosity**

Use the Hydraulic Fluid block or the Custom Hydraulic Fluid block to specify the fluid properties.

Ports

The block has the following ports:

A

Hydraulic conserving port associated with the pipe inlet.

B

Hydraulic conserving port associated with the pipe outlet.

References

[1] White, F.M., *Viscous Fluid Flow*, McGraw-Hill, 1991

Extended Capabilities

C/C++ Code Generation

Generate C and C++ code using Simulink® Coder™.

See Also

Hydraulic Pipeline | Hydraulic Pipe LP | Hydraulic Pipe LP with Variable Elevation | Linear Hydraulic Resistance | Resistive Pipe LP with Variable Elevation | Hydraulic Resistive Tube | Segmented Pipeline | Segmented Pipe LP

Topics

“Upgrading Simscape Fluids Models Containing Hydraulics (Isothermal) Blocks”

Introduced in R2009a

Resistive Pipe LP with Variable Elevation

Hydraulic pipeline which accounts for friction losses and variable port elevations



Library

Low-Pressure Blocks

Description

The Resistive Pipe LP with Variable Elevation block models hydraulic pipelines with circular and noncircular cross sections and accounts for resistive property only. Use this block for low-pressure system simulation in which the pipe ends change their positions with respect to the reference plane. The elevations are provided through respective physical signal inputs.

To reduce model complexity, you can use this block to simulate not only a pipe itself, but also a combination of pipes and local resistances such as bends, fittings, inlet and outlet losses, associated with the pipe. You must convert the resistances into their equivalent lengths, and then sum up all the resistances to obtain their aggregate length. Then add this length to the pipe geometrical length.

Pressure loss due to friction is computed with the Darcy equation, in which losses are proportional to the flow regime-dependable friction factor and the square of the flow rate. The friction factor in turbulent regime is determined with the Haaland approximation (see [1] on page 1-1391). The friction factor during transition from laminar to turbulent regimes is determined with the linear interpolation between extreme points of the regimes. As a result of these assumptions, the tube is simulated according to the following equations:

$$p = f \frac{(L + L_{eq})}{D_H} \frac{\rho}{2A^2} q \cdot |q| + \rho \cdot g(z_B - z_A)$$

$$f = \begin{cases} K_S/Re & \text{for } Re < = Re_L \\ f_L + \frac{f_T - f_L}{Re_T - Re_L} (Re - Re_L) & \text{for } Re_L < Re < Re_T \\ \frac{1}{\left(-1.8 \log_{10} \left(\frac{6.9}{Re} + \left(\frac{r/D_H}{3.7} \right)^{1.11} \right) \right)^2} & \text{for } Re > = Re_T \end{cases}$$

$$Re = \frac{q \cdot D_H}{A \cdot \nu}$$

where

p	Pressure loss along the pipe due to friction
q	Flow rate through the pipe
Re	Reynolds number
Re_L	Maximum Reynolds number at laminar flow
Re_T	Minimum Reynolds number at turbulent flow
K_s	Shape factor that characterizes the pipe cross section
f_L	Friction factor at laminar border
f_T	Friction factor at turbulent border
A	Pipe cross-sectional area
D_H	Pipe hydraulic diameter
L	Pipe geometrical length
L_{eq}	Aggregate equivalent length of local resistances
r	Height of the roughness on the pipe internal surface
ν	Fluid kinematic viscosity
z_A, z_B	Elevations of the pipe port A and port B, respectively
g	Gravity acceleration

The block positive direction is from port A to port B. This means that the flow rate is positive if it flows from A to B, and the pressure loss is determined as $p = p_A - p_B$.

Basic Assumptions and Limitations

- Flow is assumed to be fully developed along the pipe length.
- Fluid inertia, fluid compressibility, and wall compliance are not taken into account.

Parameters

- “Basic Parameters Tab” on page 1-1389
- “Variables Tab” on page 1-1390

Basic Parameters Tab

Pipe cross section type

The type of pipe cross section: **Circular** or **Noncircular**. For a circular pipe, you specify its internal diameter. For a noncircular pipe, you specify its hydraulic diameter and pipe cross-sectional area. The default value of the parameter is **Circular**.

Internal diameter

Pipe internal diameter. The parameter is used if **Pipe cross section type** is set to **Circular**. The default value is 0.01 m.

Noncircular pipe cross-sectional area

Pipe cross-sectional area. The parameter is used if **Pipe cross section type** is set to **Noncircular**. The default value is $1e-4 \text{ m}^2$.

Noncircular pipe hydraulic diameter

Hydraulic diameter of the pipe cross section. The parameter is used if **Pipe cross section type** is set to Noncircular. The default value is 0.0112 m.

Geometrical shape factor

Used for computing friction factor at laminar flow. The shape of the pipe cross section determines the value. For a pipe with a noncircular cross section, set the factor to an appropriate value, for example, 56 for a square, 96 for concentric annulus, 62 for rectangle (2:1), and so on [1 on page 1-1391]. The default value is 64, which corresponds to a pipe with a circular cross section.

Pipe length

Pipe geometrical length. The default value is 5 m.

Aggregate equivalent length of local resistances

This parameter represents total equivalent length of all local resistances associated with the pipe. You can account for the pressure loss caused by local resistances, such as bends, fittings, armature, inlet/outlet losses, and so on, by adding to the pipe geometrical length an aggregate equivalent length of all the local resistances. The default value is 1 m.

Internal surface roughness height

Roughness height on the pipe internal surface. The parameter is typically provided in data sheets or manufacturer's catalogs. The default value is 1.5e-5 m, which corresponds to drawn tubing.

Laminar flow upper margin

Specifies the Reynolds number at which the laminar flow regime is assumed to start converting into turbulent. Mathematically, this is the maximum Reynolds number at fully developed laminar flow. The default value is 2000.

Turbulent flow lower margin

Specifies the Reynolds number at which the turbulent flow regime is assumed to be fully developed. Mathematically, this is the minimum Reynolds number at turbulent flow. The default value is 4000.

Gravitational acceleration

Value of the gravitational acceleration constant (g). The block uses this parameter to calculate time changes in pressure due to time changes in elevation. The default value is 9.80655 m/s².

Variables Tab**Pressure drop from port A to port B**

Value at time zero of the pressure drop between the ports. Simscape software uses this parameter to guide the initial configuration of this component and of the model. Initial variables that conflict with each other or that are incompatible with the model may be ignored. Set the **Priority** column to High to prioritize this variable over other, lower-priority, variables.

Flow rate from port A to port B

Value at time zero of the flow rate through the ports. Simscape software uses this parameter to guide the initial configuration of this component and of the model. Initial variables that conflict with each other or that are incompatible with the model may be ignored. Set the **Priority** column to High to prioritize this variable over other, lower-priority, variables.

Global Parameters

Parameters determined by the type of working fluid:

- **Fluid density**
- **Fluid kinematic viscosity**

Use the Hydraulic Fluid block or the Custom Hydraulic Fluid block to specify the fluid properties.

Ports

The block has the following ports:

A

Hydraulic conserving port associated with the pipe inlet.

B

Hydraulic conserving port associated with the pipe outlet.

e_l_A

Physical signal input port that controls pipe elevation at port A.

e_l_B

Physical signal input port that controls pipe elevation at port B.

References

[1] White, F.M., *Viscous Fluid Flow*, McGraw-Hill, 1991

Extended Capabilities

C/C++ Code Generation

Generate C and C++ code using Simulink® Coder™.

See Also

Hydraulic Pipeline | Hydraulic Pipe LP | Hydraulic Pipe LP with Variable Elevation | Linear Hydraulic Resistance | Resistive Pipe LP | Hydraulic Resistive Tube | Segmented Pipeline | Segmented Pipe LP

Topics

“Upgrading Simscape Fluids Models Containing Hydraulics (Isothermal) Blocks”

Introduced in R2010a

Rotating Channel (IL)

Rotating pipe with a fluid channel in an isothermal liquid network

Library: Simscape / Fluids / Isothermal Liquid / Pipes & Fittings

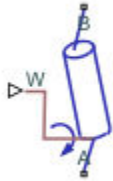

Description

The Rotating Channel (IL) block models a rotating pipe with a fluid channel in an isothermal liquid network. The pipe angular velocity is set by a physical signal at port **W**. Ports **A** and **B** are isothermal liquid inlet and outlet ports.

Fluid passing through a rotating channel experiences pressure changes due to resistance passing through the casing orifice and due to the fluid angular momentum. An internal connection to an Orifice (IL) block accounts for the local resistances. The pressure change in the block is modeled as:

$$P = \rho_A W^2 \frac{r_B^2}{2},$$

where:

- ρ_A is the fluid density at port **A**.
- W is the shaft angular velocity, received as a physical signal at port **W**.
- r_B is the radius of rotation at port **B**.

The isothermal liquid outlet port can be connected to a Rotating Cylinder Force (IL) block to model components such as a Rotating Single-Acting Actuator (IL).

Assumptions and Limitations

- The effects of fluid inertia are not calculated.
- The pipe angular velocity is assumed to be constant or changes very slowly.

Ports

Conserving

A — Liquid port

isothermal liquid

Liquid entry or exit port.

B — Liquid port

isothermal liquid

Liquid entry or exit port.

Input

W — Angular velocity, rad/s

physical signal

Rotating shaft angular velocity in rad/s, specified as a physical signal.

Parameters

Channel area — Shaft channel cross-sectional area

$1e-3 \text{ m}^2$ (default) | positive scalar

Shaft channel cross-sectional area for liquid entry/exit.

Port B radius of rotation — Rotation radius

0.01 m (default) | positive scalar

Radius of swept circle of pipe rotation, specified at port **B**.

Discharge coefficient — Discharge coefficient

0.64 (default) | positive scalar

Correction factor that accounts for discharge losses in theoretical flows.

Critical Reynolds number — Upper Reynolds number limit for laminar flow

150 (default) | positive scalar

Upper Reynolds number limit for laminar flow through the orifice.

See Also

Rotating Cylinder Force (IL) | Orifice (IL) | Rotating Single-Acting Actuator (IL) | Single-Acting Rotary Actuator (IL) | Valve Plate Orifice (IL)

Introduced in R2020a

Rotating Cylinder Force (IL)

Centripetal pressure gradient for components in an isothermal liquid system

Library: Simscape / Fluids / Isothermal Liquid / Actuators / Auxiliary Components



Description

The Rotating Cylinder Force (IL) block models the axial force due to a centripetal pressure gradient in a rotating shaft about its symmetry axis, which is found in applications such as friction clutches, square-jaw positive clutches, dog clutches, and brakes. Connect this block in parallel to a Single-Acting Actuator (IL) or a Translational Mechanical Converter (IL) block to model a rotating actuator. The fluid density is recorded at the isothermal liquid port **X**. The angular velocity is received as a physical signal at port **W**. Port **R** is associated with the piston velocity, relative to the case at port **C**.

The angular velocity of the shaft is assumed to be constant or nearly-constant, and therefore the fluid is considered to be in rigid-body rotation.

The centripetal force is due solely to the fluid angular momentum induced by shaft rotation. Removing the contribution of the static pressure in the fluid channel, the contribution of the rotation of the shaft to the axial force is:

$$F_{rotational} = \frac{\rho\pi W^2}{4}(r_o^2 - r_i^2 - 2r_p^2(r_o^2 - r_i^2)),$$

where:

- ρ is the fluid density at port **X**.
- W is the angular velocity of the rotating pipe, received as a physical signal at port **W**.
- r_o is the **Piston outer radius**.
- r_i is the **Piston inner radius**.
- r_p is the **Fluid entry radius**.

Ports

Conserving

X – Liquid density port

isothermal liquid

Liquid port associated with fluid density. There is no mass flow through port **X**. Connect port **X** to port **A** of the Single-Acting Actuator (IL) or Translational Mechanical Converter (IL) blocks.

C – Cylinder casing

mechanical translational

Mechanical translational conserving port associated with the cylinder casing reference velocity and force.

R – Piston

mechanical translational

Mechanical translational conserving port associated with the piston velocity and force induced by the pressure differential.

Input

W – Angular velocity, rad/s

physical signal

Angular velocity in rad/s, specified as a physical signal.

Parameters

Piston outer radius – Piston outer radius

0.1 m (default) | positive scalar

Piston outer radius.

Piston inner radius – Piston inner radius

0.05 m (default) | positive scalar

Piston inner radius.

Fluid entry radius – Fluid channel radius

0.06 m (default) | positive scalar

Radius of the fluid opening in the cylinder casing, measured from the rotational axis. This value must be greater than or equal to the **Piston inner radius** and less than or equal to the **Piston outer radius**.

Actuator mechanical orientation – Piston displacement direction

Pressure at A causes positive displacement of R relative to C (default) | Pressure at A causes negative displacement of R relative to C

Piston displacement direction of the connected actuator block. Pressure at A causes positive displacement of R relative to C corresponds to positive displacement, or actuator shaft extension, when **R - C** is positive. Pressure at A causes negative displacement of R relative to C corresponds to negative displacement, or actuator shaft retraction, when **R - C** is positive.

See Also

Rotating Channel (IL) | Single-Acting Actuator (IL) | Translational Mechanical Converter (IL) | Single-Acting Rotary Actuator (IL)

Introduced in R2020a

Rotating Pipe

Hydraulic pipeline created by bore in rotating housing



Library

Pipelines

Description

The Rotating Pipe block models a hydraulic pipeline represented as a short bore drilled through a shaft at some angle to its axis, or as a short pipe that connects actuator or bearings, mounted on the shaft, with the channel inside the shaft. Such connections are typical for lubrication systems and for hydraulically-operated clutches and mechanisms. The shaft angular velocity is assumed to be constant or changing at very low speed. The block is implemented as a structural model, shown in the diagram below:

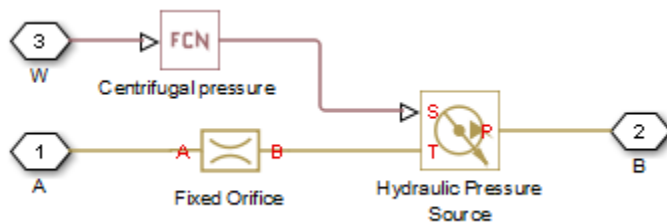

The Fixed Orifice block simulates pressure losses in the bore. The pipe is assumed to be short enough to be characterized by a flow-pressure relationship similar to that of the fixed orifice. The model accounts for the laminar and turbulent flow regimes by monitoring the Reynolds number (Re) and comparing its value with the critical Reynolds number (Re_{cr}). The Hydraulic Pressure Source block represents pumping action developed by a rotating pipe, which is calculated with the equation:

$$p = \rho \cdot \frac{\omega^2 \cdot r_B^2}{2}$$

where

p	Pressure at the pipe outlet
ρ	Fluid density
ω	Shaft angular velocity

r_B	Radius of the pipe outlet
-------	---------------------------

Connections A and B are conserving hydraulic ports associated with the pipe inlet and outlet, respectively. Connection W is the physical signal input port that provides the shaft angular velocity value.

Basic Assumptions and Limitations

- The pipe is assumed to be short, to be simulated with the fixed orifice.
- Flow is assumed to be fully developed along the pipe length.
- The transition between laminar and turbulent regimes is assumed to be sharp and taking place exactly at $Re=Re_{cr}$.
- Fluid inertia is not taken into account.
- Fluid compressibility is not taken into account.

Parameters

Pipe cross-section area

Cross-sectional area of the pipe. The default value is $1e-4 \text{ m}^2$.

Port B radius of rotation

Radius of rotation of the outer end of the pipe. The default value is 0.03 m .

Flow discharge coefficient

Semi-empirical parameter for pipe capacity characterization. Its value depends on the geometrical properties of the pipe, and usually is provided in textbooks or manufacturer data sheets. The default value is 0.6 .

Critical Reynolds number

The maximum Reynolds number for laminar flow. The transition from laminar to turbulent regime is assumed to take place when the Reynolds number reaches this value. The value of the parameter depends on the pipe geometrical profile. You can find recommendations on the parameter value in hydraulics textbooks. The default value is 12 , which corresponds to a round orifice in thin material with sharp edges.

Global Parameters

Parameters determined by the type of working fluid:

- **Fluid density**
- **Fluid kinematic viscosity**

Use the Hydraulic Fluid block or the Custom Hydraulic Fluid block to specify the fluid properties.

Examples

For an example on page 1-381 of using the Rotating Pipe block to model a custom single-acting hydraulic cylinder, see the Centrifugal Force in Rotating Cylinder block reference page.

Ports

The block has the following ports:

A

Hydraulic conserving port associated with the pipe inlet.

B

Hydraulic conserving port associated with the pipe outlet.

W

Physical signal port providing the angular velocity value.

Extended Capabilities

C/C++ Code Generation

Generate C and C++ code using Simulink® Coder™.

See Also

Centrifugal Force in Rotating Cylinder

Topics

“Upgrading Simscape Fluids Models Containing Hydraulics (Isothermal) Blocks”

Introduced in R2010a

Rotating Single-Acting Actuator (IL)

Actuator on a rotating shaft in an isothermal liquid network

Library: Simscape / Fluids / Isothermal Liquid / Actuators



Description

The Rotating Single-Acting Actuator (IL) block models an actuator that rotates around its central axis in an isothermal liquid network. Rotating actuators are used in rotating shaft control components such as friction clutches or brakes. The fluid enters the actuator at port **A**. The angular velocity is set at port **W**. Port **C** is associated with the actuator casing and the piston velocity and force are set at port **R**.

When the piston position is calculated internally, it is reported at port **p**, and when the position is set by a connection to a Simscape Multibody joint, it is received as a physical signal at port **p**. The motion of the piston when it is near full extension or full retraction is limited by one of three hard stop models. **Fluid dynamic compressibility** can optionally be modeled.

Displacement

The piston displacement is measured as the position at port **R** relative to port **C**. The **Mechanical orientation** identifies the direction of piston displacement. The piston displacement is neutral, or Θ , when the chamber volume is equal to the **Dead volume**. When displacement is received as an input, ensure that the derivative of the position is equal to the piston velocity. This is automatically the case when the input is received from a Translational Multibody Interface block connection to a Simscape Multibody joint.

Hard Stop Model

To avoid mechanical damage to an actuator when it is fully extended or fully retracted, an actuator typically displays nonlinear behavior when the piston approaches these limits. The Double-Acting Actuator (IL) block models this behavior with a choice of three hard stop models, which model the material compliance through a spring-damper system. The hard stop models are:

- Stiffness and damping applied smoothly through transition region, damped rebound.
- Full stiffness and damping applied at bounds, undamped rebound.
- Full stiffness and damping applied at bounds, damped rebound.

The hard stop force is modeled when the piston is at its upper or lower bound. The boundary region is within the **Transition region** of the **Piston stroke** or piston initial displacement. Outside of this region, $F_{HardStop} = 0$.

For more information about these settings, see the Translational Hard Stop block page.

Block Subcomponents

The Rotating Single-Acting Actuator (IL) block comprises three Isothermal Liquid library blocks:

- Rotating Channel (IL)
- Single-Acting Actuator (IL)
- Rotating Cylinder Force (IL)

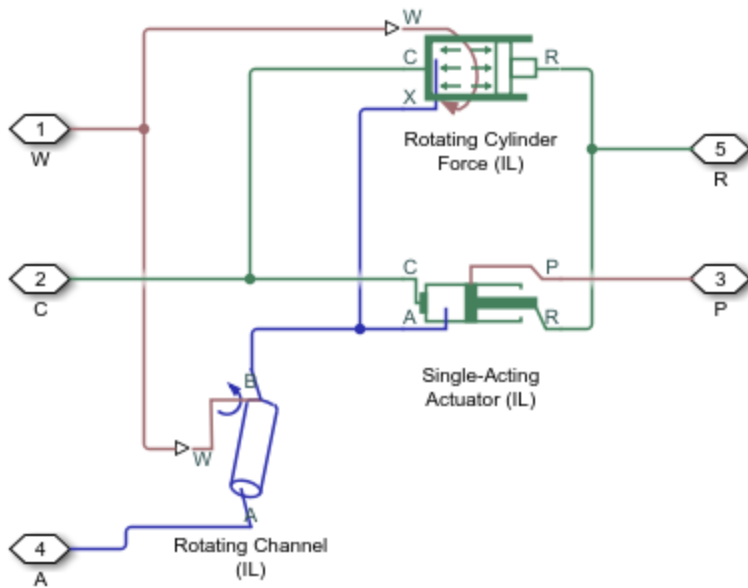

Actuator Schematic

Ports

Conserving

A – Liquid chamber inlet port

isothermal liquid

Inlet port to the liquid chamber.

C – Actuator casing

mechanical translational

Reference port for actuator velocity and force.

R – Rod velocity

mechanical translational

Port associated with the piston velocity and force.

Input

W – Actuator rotational velocity

physical signal

Actuator rotational velocity, received as a physical signal in rad/s.

p — Piston position, m

physical signal

Piston position in m, received as a physical signal from a Simscape Multibody block.

Dependencies

To expose this port, set **Piston displacement** to Provide input signal from Multibody joint.

Output**p — Piston position, m**

physical signal

Piston position in m, returned as a physical signal.

Dependencies

To expose this port, set **Piston displacement** to Calculate from velocity of port R relative to port C.

Parameters**Actuator****Piston outer radius — Piston outer radius**

0.1 m (default) | positive scalar

Piston outer radius.

Piston inner radius — Piston inner radius

0.05 m (default) | positive scalar

Piston inner radius.

Mechanical orientation — Piston displacement direction

Pressure at A causes positive displacement of R relative to C (default) | Pressure at A causes negative displacement of R relative to C

Sets the piston displacement direction. When you set this parameter to:

- Pressure at A causes positive displacement of R relative to C the piston displacement is positive when the volume of liquid at port A is expanding. This corresponds to rod extension.
- Pressure at A causes negative displacement of R relative to C the piston displacement is negative when the volume of liquid at port A is expanding. This corresponds to rod contraction.

Piston stroke — Maximum piston travel distance

0.1 m (default) | positive scalar

Maximum piston travel distance.

Dead volume — Fluid volume at full piston retraction1e-5 m³ (default) | positive scalar

Volume of liquid when the piston displacement is 0. This is the liquid volume when the piston is up against the actuator end cap.

Environment pressure specification — Reference environment pressure

Atmospheric pressure (default) | Specified pressure

Environment reference pressure. The Atmospheric pressure option sets the environmental pressure to 0.101325 MPa.

Environment pressure — User-defined environmental pressure

0.101325 MPa (default) | positive scalar

User-defined environmental pressure.

Dependencies

To enable this parameter, set **Environment pressure specification** to Specified pressure.

Fluid Channel**Fluid entry radius — Fluid channel radius**

0.06 m (default) | positive scalar

Radius of the fluid opening in the rotating shaft. This value must be greater than or equal to the **Piston inner radius** and less than or equal to the **Piston outer radius**.

Fluid channel cross-sectional area — Fluid cross-sectional area

1e-3 m² (default) | positive scalar

Cross-sectional area of the fluid channel.

Discharge coefficient — Discharge coefficient

0.64 (default) | positive scalar

Flow discharge loss coefficient.

Critical Reynolds number — Upper Reynolds number limit for laminar flow

150 (default) | positive scalar

Upper Reynolds number limit for laminar flow through the orifice.

Hard Stop**Hard-stop stiffness coefficient — Stiffness coefficient**

1e10 N/m (default) | positive scalar

Piston stiffness coefficient. This value must be greater than 0.

Hard-stop damping coefficient — Damping coefficient

150 N/(m/s) (default) | positive scalar

Piston damping coefficient.

Hard stop model — Model choice for force on piston at full extension or retraction

Stiffness and damping applied smoothly through transition region, damped rebound (default) | Full stiffness and damping applied at bounds, undamped rebound | Full stiffness and damping applied at bounds, damped rebound

Model choice for the force on the piston at full extension or full retraction. See the Translational Hard Stop block for more information.

Transition region — Application range of hard stop force model

0.1 mm (default) | positive scalar

Application range of the hard stop force model. Outside of the range of the piston maximum extension and piston maximum retraction, the **Hard stop model** is not applied and there is no additional force on the piston.

Dependencies

To enable this parameter, set **Hard stop model** to Stiffness and damping applied smoothly through transition region, damped rebound.

Initial Conditions

Piston displacement — Method for determining piston position

Calculate from velocity of port R relative to port C (default) | Provide input signal from Multibody joint

Method for determining the piston position. The block can receive the position from a Multibody block when set to Provide input signal from Multibody joint, or calculates the position internally and reports the position at port **p**. The position is between 0 and the **Piston stroke** when the mechanical orientation is positive and 0 and **-Piston stroke** when the mechanical orientation is negative.

Initial piston displacement — Piston position at start of simulation

0 m (default) | scalar

Piston position at the start of the simulation.

Dependencies

To enable this parameter, set **Piston displacement** to Calculate from velocity of port R relative to port C.

Fluid dynamic compressibility — Whether to model fluid compressibility

On (default) | Off

Whether to model any change in fluid density due to fluid compressibility. When **Fluid compressibility** is set to On, changes due to the mass flow rate into the block are calculated in addition to density changes due to changes in pressure. In the Isothermal Liquid Library, all blocks calculate density as a function of pressure.

Initial liquid pressure — Starting liquid pressure for compressible fluids

0.101325 MPa (default) | positive scalar

Starting liquid pressure for compressible fluids.

Dependencies

To enable this parameter, set **Fluid dynamic compressibility** to On.

See Also

Single-Acting Actuator (IL) | Single-Acting Rotary Actuator (IL) | Pilot Valve Actuator (IL) | Double-Acting Actuator (IL) | Double-Acting Actuator (G-IL)

Topics

“Connecting Simscape Networks to Simscape Multibody Joints”

Introduced in R2020a

Segmented Pipeline

Hydraulic pipeline with resistive, fluid inertia, and fluid compressibility properties



Library

Pipelines

Description

The Segmented Pipeline block models hydraulic pipelines with circular cross sections. Hydraulic pipelines, which are inherently distributed parameter elements, are represented with sets of identical, connected in series, lumped parameter segments. It is assumed that the larger the number of segments, the closer the lumped parameter model becomes to its distributed parameter counterpart. The equivalent circuit of a pipeline adopted in the block is shown below, along with the segment configuration.

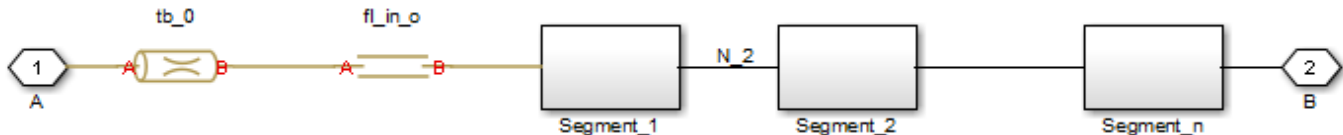

Pipeline Equivalent Circuit

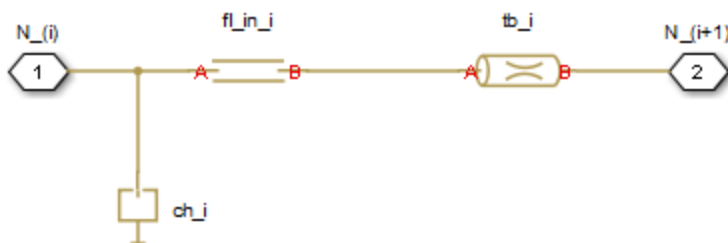

Segment Configuration

The model contains as many Constant Volume Hydraulic Chamber blocks as there are segments. The chamber lumps fluid volume equal to

$$V = \frac{\pi \cdot d^2 L}{4 N}$$

where

V	Fluid volume
d	Pipe diameter
L	Pipe length
N	Number of segments

The Constant Volume Hydraulic Chamber block is placed between two branches, each consisting of a Hydraulic Resistive Tube block and a Fluid Inertia block. Every Hydraulic Resistive Tube block lumps $(L+L_{ad})/(N+1)$ -th portion of the pipe length, while Fluid Inertia block has $L/(N+1)$ length (L_{ad} denotes additional pipe length equal to aggregate equivalent length of pipe local resistances, such as fitting, elbows, bends, and so on).

The nodes to which Constant Volume Hydraulic Chamber blocks are connected are assigned names N_1, N_2, \dots, N_n (n is the number of segments). Pressures at these nodes are assumed to be equal to average pressure of the segment. Intermediate nodes between Hydraulic Resistive Tube and Fluid Inertia blocks are assigned names $nn_0, nn_1, nn_2, \dots, nn_n$. The Constant Volume Hydraulic Chamber blocks are named ch_1, ch_2, \dots, ch_n , Hydraulic Resistive Tube blocks are named $tb_0, tb_1, tb_2, \dots, tb_n$, and Fluid Inertia blocks are named $fl_in_0, fl_in_1, fl_in_2, \dots, fl_in_n$.

The number of segments determines the number of computational nodes associated with the block. A higher number increases model fidelity but decreases simulation speed. Experiment with different numbers to obtain a suitable trade-off between accuracy and speed. Use the following equation as a starting point in estimating a suitable number of segments:

$$N > \frac{4L}{\pi \cdot c} \omega$$

where:

N	Number of segments
L	Pipe length
c	Speed of sound in the fluid
ω	Maximum frequency to be observed in the pipe response

The table contains an example of simulation of a pipeline where the first four true eigenfrequencies are 89.1 Hz, 267 Hz, 446 Hz, and 624 Hz.

Number of Segments	1st Mode	2nd Mode	3rd Mode	4th Mode
1	112.3	-	-	-
2	107.2	271.8	-	-
4	97.7	284.4	432.9	689
8	93.2	271.9	435.5	628

The error between simulated and actual eigenfrequencies is less than 5% if an eight-segment model is used.

The flow rate through the pipeline is positive if it is directed from port A to port B. The pressure differential is positive if pressure is higher at port A than at port B.

Basic Assumptions and Limitations

Flow is assumed to be fully developed along the pipe length.

Parameters

Pipe internal diameter

Internal diameter of the pipe. The default value is 0.01 m.

Pipe length

Pipe geometrical length. The default value is 5 m.

Number of segments

Number of lumped parameter segments in the pipeline model. The default value is 1.

Aggregate equivalent length of local resistances

This parameter represents total equivalent length of all local resistances associated with the pipe. You can account for the pressure loss caused by local resistances, such as bends, fittings, armature, inlet/outlet losses, and so on, by adding to the pipe geometrical length an aggregate equivalent length of all the local resistances. This length is added to the geometrical pipe length only for hydraulic resistance computation. Both the fluid volume and fluid inertia are determined based on pipe geometrical length only. The default value is 1 m.

Internal surface roughness height

Roughness height on the pipe internal surface. The parameter is typically provided in data sheets or manufacturer's catalogs. The default value is $1.5e-5$ m, which corresponds to drawn tubing.

Laminar flow upper margin

Specifies the Reynolds number at which the laminar flow regime is assumed to start converting into turbulent. Mathematically, this is the maximum Reynolds number at fully developed laminar flow. The default value is 2000.

Turbulent flow lower margin

Specifies the Reynolds number at which the turbulent flow regime is assumed to be fully developed. Mathematically, this is the minimum Reynolds number at turbulent flow. The default value is 4000.

Pipe wall type

The parameter can have one of two values: `Rigid Wall` or `Flexible Wall`. If the parameter is set to `Rigid Wall`, wall compliance is not taken into account, which can improve computational efficiency. The value `Flexible Wall` is recommended for hoses and metal pipes where wall compliance can affect the system behavior. The default value is `Rigid Wall`.

Static pressure-diameter coefficient

Coefficient that establishes relationship between the pressure and the internal diameter at steady-state conditions. This coefficient can be determined analytically for cylindrical metal pipes or experimentally for hoses. The parameter is used if the **Pipe wall type** parameter is set to `Flexible Wall`, and the default value is $2e-10$ m/Pa.

Viscoelastic process time constant

Time constant in the transfer function that relates pipe internal diameter to pressure variations. By using this parameter, the simulated elastic or viscoelastic process is approximated with the first-order lag. The value is determined experimentally or provided by the manufacturer. The default value is 0.008 s.

Specific heat ratio

Gas-specific heat ratio for the Constant Volume Hydraulic Chamber block. The default value is 1.4.

Initial pressures at model nodes

Lets you specify the initial condition for pressure inside the pipe segments. The parameter can have one of two values:

- **The same initial pressure for all nodes** — The initial pressure in all pipe segments is the same, and is specified by the **Initial pressure** parameter value. This is the default.
- **Custom** — Lets you specify initial pressure individually for each pipe segment, by using the **Initial pressure vector** parameter. The vector size must be equal to the number of pipe segments, defined by the **Number of segments** parameter value.

Initial pressure

Specifies the initial pressure in all pipe segments. The parameter is used if the **Initial pressures at model nodes** parameter is set to **The same initial pressure for all nodes**, and the default value is 0.

Initial pressure vector

Lets you specify initial pressure individually for each pipe segment. The parameter is used if the **Initial pressures at model nodes** parameter is set to **Custom**. The vector size must be equal to the number of pipe segments, defined by the **Number of segments** parameter value.

Initial flow rate

Specifies the initial volumetric flow rate through the pipe. The default value is 0 m³/s.

Restricted Parameters

When your model is in Restricted editing mode, you cannot modify the following parameters:

- **Pipe wall type**
- **Initial pressures at model nodes**

All other block parameters are available for modification.

Global Parameters

Parameters determined by the type of working fluid:

- **Fluid density**
- **Fluid kinematic viscosity**

Use the Hydraulic Fluid block or the Custom Hydraulic Fluid block to specify the fluid properties.

Ports

The block has the following ports:

A

Hydraulic conserving port associated with the pipe inlet.

B

Hydraulic conserving port associated with the pipe outlet.

Extended Capabilities

C/C++ Code Generation

Generate C and C++ code using Simulink® Coder™.

See Also

[Hydraulic Pipeline](#) | [Linear Hydraulic Resistance](#) | [Hydraulic Resistive Tube](#)

Topics

[“Upgrading Simscape Fluids Models Containing Hydraulics \(Isothermal\) Blocks”](#)

Introduced in R2006a

Segmented Pipe LP

Hydraulic pipeline with resistive, fluid inertia, fluid compressibility, and elevation properties



Library

Low-Pressure Blocks

Description

The Segmented Pipe LP block models hydraulic pipelines with circular cross sections. Hydraulic pipelines, which are inherently distributed parameter elements, are represented with sets of identical, connected in series, lumped parameter segments. It is assumed that the larger the number of segments, the closer the lumped parameter model becomes to its distributed parameter counterpart. The equivalent circuit of a pipeline adopted in the block is shown below, along with the segment configuration.

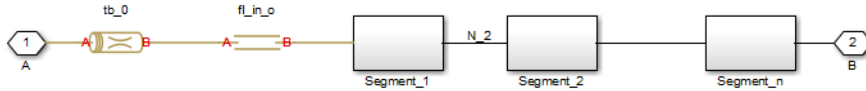

Pipeline Equivalent Circuit

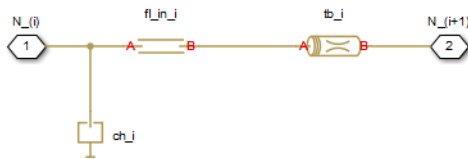

Segment Configuration

The model contains as many Constant Volume Hydraulic Chamber blocks as there are segments. The chamber lumps fluid volume equal to

$$V = \frac{\pi \cdot d^2 L}{4 N}$$

where

V	Fluid volume
d	Pipe diameter
L	Pipe length

N	Number of segments
-----	--------------------

The Constant Volume Hydraulic Chamber block is placed between two branches, each consisting of a Resistive Pipe LP block and a Fluid Inertia block. Every Resistive Pipe LP block lumps $(L+L_{ad})/(N+1)$ -th portion of the pipe length, while Fluid Inertia block has $L/(N+1)$ length (L_{ad} denotes additional pipe length equal to aggregate equivalent length of pipe local resistances, such as fitting, elbows, bends, and so on).

The nodes to which Constant Volume Hydraulic Chamber blocks are connected are assigned names N_1, N_2, \dots, N_n (n is the number of segments). Pressures at these nodes are assumed to be equal to average pressure of the segment. Intermediate nodes between Resistive Pipe LP and Fluid Inertia blocks are assigned names $nn_0, nn_1, nn_2, \dots, nn_n$. The Constant Volume Hydraulic Chamber blocks are named ch_1, ch_2, \dots, ch_n , Resistive Pipe LP blocks are named $tb_0, tb_1, tb_2, \dots, tb_n$, and Fluid Inertia blocks are named $fl_in_0, fl_in_1, fl_in_2, \dots, fl_in_n$.

The number of segments determines the number of computational nodes associated with the block. A higher number increases model fidelity but decreases simulation speed. Experiment with different numbers to obtain a suitable trade-off between accuracy and speed. Use the following equation as a starting point in estimating a suitable number of segments:

$$N > \frac{4L}{\pi \cdot c} \omega$$

where

N	Number of segments
L	Pipe length
c	Speed of sound in the fluid
ω	Maximum frequency to be observed in the pipe response

The table below contains an example of simulation of a pipeline where the first four true eigenfrequencies are 89.1 Hz, 267 Hz, 446 Hz, and 624 Hz.

Number of Segments	1st Mode	2nd Mode	3rd Mode	4th Mode
1	112.3	-	-	-
2	107.2	271.8	-	-
4	97.7	284.4	432.9	689
8	93.2	271.9	435.5	628

As you can see, the error is less than 5% if an eight-segmented version is used.

The difference in elevation between ports A and B is distributed evenly between pipe segments.

The block positive direction is from port A to port B. This means that the flow rate is positive if it flows from A to B, and the pressure loss is determined as $\Delta p = p_A - p_B$.

Basic Assumptions and Limitations

Flow is assumed to be fully developed along the pipe length.

Parameters

- “Basic Parameters Tab” on page 1-1412
- “Wall Compliance Tab” on page 1-1412
- “Vertical Position Tab” on page 1-1413

Basic Parameters Tab

Pipe internal diameter

Internal diameter of the pipe. The default value is 0.01 m.

Pipe length

Pipe geometrical length. The default value is 5 m.

Number of segments

Number of lumped parameter segments in the pipeline model. The default value is 1.

Aggregate equivalent length of local resistances

This parameter represents total equivalent length of all local resistances associated with the pipe. You can account for the pressure loss caused by local resistances, such as bends, fittings, armature, inlet/outlet losses, and so on, by adding to the pipe geometrical length an aggregate equivalent length of all the local resistances. This length is added to the geometrical pipe length only for hydraulic resistance computation. Both the fluid volume and fluid inertia are determined based on pipe geometrical length only. The default value is 1 m.

Internal surface roughness height

Roughness height on the pipe internal surface. The parameter is typically provided in data sheets or manufacturer’s catalogs. The default value is $1.5e-5$ m, which corresponds to drawn tubing.

Laminar flow upper margin

Specifies the Reynolds number at which the laminar flow regime is assumed to start converting into turbulent. Mathematically, this is the maximum Reynolds number at fully developed laminar flow. The default value is 2000.

Turbulent flow lower margin

Specifies the Reynolds number at which the turbulent flow regime is assumed to be fully developed. Mathematically, this is the minimum Reynolds number at turbulent flow. The default value is 4000.

Initial liquid pressure

Gauge pressure in the pipe segments at time zero. Enter a scalar for a single-segment pipeline and a vector for a multi-segment pipeline. The number of elements in the vector must match the number of segments in the pipe. The default value is 0 Pa.

Wall Compliance Tab

Pipe wall type

The parameter can have one of two values: `Rigid Wall` or `Flexible Wall`. If the parameter is set to `Rigid Wall`, wall compliance is not taken into account, which can improve computational efficiency. The value `Flexible Wall` is recommended for hoses and metal pipes where wall compliance can affect the system behavior. The default value is `Rigid Wall`.

Static pressure-diameter coefficient

Coefficient that establishes relationship between the pressure and the internal diameter at steady-state conditions. This coefficient can be determined analytically for cylindrical metal pipes

or experimentally for hoses. The parameter is used if the **Pipe wall type** parameter is set to **Flexible**. The default value is $2e-12$ m/Pa.

Viscoelastic process time constant

Time constant in the transfer function that relates pipe internal diameter to pressure variations. By using this parameter, the simulated elastic or viscoelastic process is approximated with the first-order lag. The value is determined experimentally or provided by the manufacturer. The parameter is used if the **Pipe wall type** parameter is set to **Flexible Wall**. The default value is 0.01 s.

Specific heat ratio

Gas-specific heat ratio for the Constant Volume Hydraulic Chamber block. The default value is 1.4.

Vertical Position Tab

Port A elevation wrt reference plane

Vertical position of port **A** with respect to a reference plane. The reference plane is assumed to be the same as that used in the **Port B elevation from reference plane** parameter. The default value is 0m.

Port B elevation wrt reference plane

Vertical position of port **B** with respect to a reference plane. The reference plane is assumed to be the same as that used in the **Port A elevation from reference plane** parameter. The default value is 0m.

Gravitational acceleration

Value of the gravitational acceleration constant (g). The block uses this parameter to compute the effects of an elevation gradient between the ports on their pressure differential. The default value is 9.80665 m/s².

Restricted Parameters

When your model is in Restricted editing mode, you cannot modify the following parameter:

- **Pipe wall type**

All other block parameters are available for modification. The actual set of modifiable block parameters depends on the value of the **Pipe wall type** parameter at the time the model entered Restricted mode.

Global Parameters

Parameters determined by the type of working fluid:

- **Fluid density**
- **Fluid kinematic viscosity**

Use the Hydraulic Fluid block or the Custom Hydraulic Fluid block to specify the fluid properties.

Ports

The block has the following ports:

A

Hydraulic conserving port associated with the pipe inlet.

B

Hydraulic conserving port associated with the pipe outlet.

References

[1] White, F.M., *Viscous Fluid Flow*, McGraw-Hill, 1991

Extended Capabilities

C/C++ Code Generation

Generate C and C++ code using Simulink® Coder™.

See Also

[Hydraulic Pipeline](#) | [Hydraulic Pipe LP](#) | [Linear Hydraulic Resistance](#) | [Resistive Pipe LP](#) | [Hydraulic Resistive Tube](#) | [Segmented Pipeline](#)

Topics

“Upgrading Simscape Fluids Models Containing Hydraulics (Isothermal) Blocks”

Introduced in R2009a

Shuttle Valve

Hydraulic valve that allows flow in one direction only



Library

Directional Valves

Description

The Shuttle Valve block represents a hydraulic shuttle valve as a data-sheet-based model. The valve has two inlet ports (A and A1) and one outlet port (B). The valve is controlled by pressure differential $p_c = p_A - p_{A1}$. The valve permits flow either between ports A and B or between ports A1 and B, depending on the pressure differential p_c . Initially, path A-B is assumed to be opened. To open path A1-B (and close A-B at the same time), pressure differential must be less than the valve cracking pressure ($p_{cr} \leq 0$).

When cracking pressure is reached, the valve control member (spool, ball, poppet, etc.) is forced off its seat and moves to the opposite seat, thus opening one passage and closing the other. If the flow rate is high enough and pressure continues to change, the control member continues to move until it reaches its extreme position. At this moment, one of the valve passage areas is at its maximum. The valve maximum area and the cracking and maximum pressures are generally provided in the catalogs and are the three key parameters of the block.

The relationship between the A-B, A1-B path openings and control pressure p_c is shown in the following illustration.

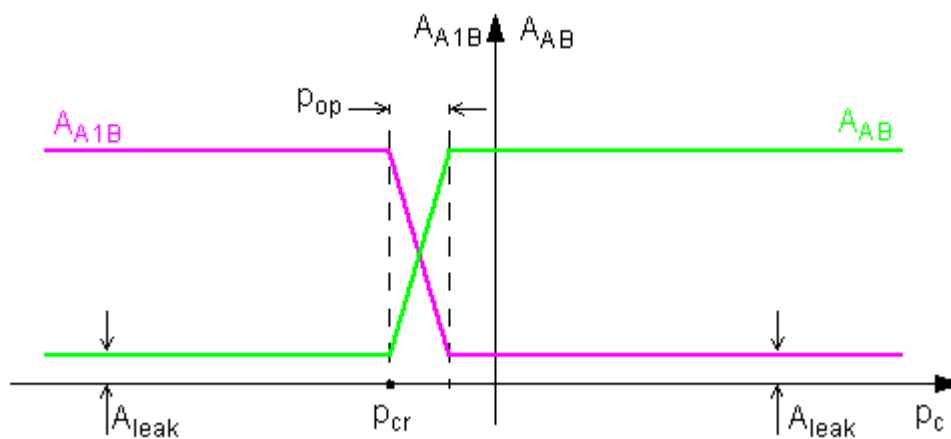

In addition to the maximum area, the leakage area is also required to characterize the valve. The main purpose of the parameter is not to account for possible leakage, even though this is also

important, but to maintain numerical integrity of the circuit by preventing a portion of the system from getting isolated after the valve is completely closed. An isolated or “hanging” part of the system could affect computational efficiency and even cause failure of computation. Therefore, the parameter value must be greater than zero.

The flow rate through each of the orifices is determined according to the following equations:

$$q_{AB} = C_D \cdot A_{AB} \sqrt{\frac{2}{\rho}} \cdot \frac{p_{AB}}{(p_{AB}^2 + p_{cr}^2)^{1/4}}$$

$$q_{A1B} = C_D \cdot A_{A1B} \sqrt{\frac{2}{\rho}} \cdot \frac{p_{A1B}}{(p_{A1B}^2 + p_{cr}^2)^{1/4}}$$

$$A_{AB} = \begin{cases} A_{leak} & \text{for } p_c \leq p_{crack} \\ A_{leak} + k \cdot (p_c - p_{crack}) & \text{for } p_{crack} < p_c < p_{crack} + p_{op} \\ A_{max} & \text{for } p_c \geq p_{crack} + p_{op} \end{cases}$$

$$A_{A1B} = \begin{cases} A_{leak} & \text{for } p_c \geq p_{crack} + p_{op} \\ A_{max} - k \cdot (p_c - p_{crack}) & \text{for } p_{crack} < p_c < p_{crack} + p_{op} \\ A_{max} & \text{for } p_c \leq p_{crack} \end{cases}$$

$$k = \frac{A_{max} - A_{leak}}{p_{op}}$$

$$p_c = p_A - p_{A1}$$

where

q_{AB}, q_{A1B}	Flow rates through the AB and A1B orifices
p_{AB}, p_{A1B}	Pressure differentials across the AB and A1B orifices
p_A, p_{A1}, p_B	Gauge pressures at the block terminals
C_D	Flow discharge coefficient
ρ	Fluid density
A_{AB}, A_{A1B}	Instantaneous orifice AB and A1B passage areas
A_{max}	Fully open orifice passage area
A_{leak}	Closed valve leakage area
p_c	Valve control pressure differential
p_{crack}	Valve cracking pressure differential
p_{op}	Pressure differential needed to fully shift the valve
p_{crAB}, p_{crA1B}	Minimum pressures for turbulent flow across the AB and A1B orifices

The minimum pressures for turbulent flow across the AB and A1B orifices, p_{crAB} and p_{crA1B} , are calculated according to the laminar transition specification method:

- By pressure ratio — The transition from laminar to turbulent regime is defined by the following equations:

$$p_{crAB} = (p_{avgAB} + p_{atm})(1 - B_{lam})$$

$$p_{crA1B} = (p_{avgA1B} + p_{atm})(1 - B_{lam})$$

$$p_{avgAB} = (p_A + p_B)/2$$

$$p_{avgA1B} = (p_{A1} + p_B)/2$$

where

p_{avgAB}	Average pressure for orifice AB
p_{avgA1B}	Average pressure for orifice A1B
p_{atm}	Atmospheric pressure, 101325 Pa
B_{lam}	Pressure ratio at the transition between laminar and turbulent regimes (Laminar flow pressure ratio parameter value)

- By Reynolds number — The transition from laminar to turbulent regime is defined by the following equations:

$$p_{crAB} = \frac{\rho}{2} \left(\frac{Re_{cr} \cdot \nu}{C_D \cdot D_{HAB}} \right)^2$$

$$p_{crA1B} = \frac{\rho}{2} \left(\frac{Re_{cr} \cdot \nu}{C_D \cdot D_{HA1B}} \right)^2$$

$$D_{HAB} = \sqrt{\frac{4A_{AB}}{\pi}}$$

$$D_{HA1B} = \sqrt{\frac{4A_{A1B}}{\pi}}$$

where

D_{HAB}, D_{HA1B}	Instantaneous orifice hydraulic diameters
ν	Fluid kinematic viscosity
Re_{cr}	Critical Reynolds number (Critical Reynolds number parameter value)

By default, the block does not include valve opening dynamics. Adding valve opening dynamics provides continuous behavior that is particularly helpful in situations with rapid valve opening and closing. The orifice passage areas A_{AB} and A_{A1B} in the equations above then become steady-state orifice AB and A1B passage areas, respectively. Instantaneous orifice AB and A1B passage areas with opening dynamics are determined as follows:

$$A_{AB_dyn}(t = 0) = A_{AB_init}$$

$$\frac{dA_{AB_dyn}}{dt} = \frac{A_{AB} - A_{AB_dyn}}{\tau}$$

$$A_{A1B_dyn} = A_{max} + A_{leak} - A_{AB_dyn}$$

where

A_{AB_dyn}	Instantaneous orifice AB passage area with opening dynamics
A_{A1B_dyn}	Instantaneous orifice A1B passage area with opening dynamics
A_{AB_init}	Initial open area for orifice AB
τ	Time constant for the first order response of the valve opening
t	Time

The block positive direction is from port A to port B and from port A1 to port B. Control pressure is determined as $p_c = p_A - p_{A1}$.

Basic Assumptions and Limitations

- Valve opening is linearly proportional to the pressure differential.
- No loading on the valve, such as inertia, friction, spring, and so on, is considered.

Parameters

Maximum passage area

Valve passage maximum cross-sectional area. The default value is $1e-4 \text{ m}^2$.

Cracking pressure

Pressure differential level at which the orifice of the valve starts to open. The default value is $-1e4 \text{ Pa}$.

Opening pressure

Pressure differential across the valve needed to shift the valve from one extreme position to another. The default value is $1e4 \text{ Pa}$.

Flow discharge coefficient

Semi-empirical parameter for valve capacity characterization. Its value depends on the geometrical properties of the orifice, and usually is provided in textbooks or manufacturer data sheets. The default value is 0.7 .

Laminar transition specification

Select how the block transitions between the laminar and turbulent regimes:

- **Pressure ratio** — The transition from laminar to turbulent regime is smooth and depends on the value of the **Laminar flow pressure ratio** parameter. This method provides better simulation robustness.
- **Reynolds number** — The transition from laminar to turbulent regime is assumed to take place when the Reynolds number reaches the value specified by the **Critical Reynolds number** parameter.

Laminar flow pressure ratio

Pressure ratio at which the flow transitions between laminar and turbulent regimes. The default value is 0.999 . This parameter is visible only if the **Laminar transition specification** parameter is set to **Pressure ratio**.

Critical Reynolds number

The maximum Reynolds number for laminar flow. The value of the parameter depends on the orifice geometrical profile. You can find recommendations on the parameter value in hydraulics

textbooks. The default value is 12, which corresponds to a round orifice in thin material with sharp edges. This parameter is visible only if the **Laminar transition specification** parameter is set to Reynolds number.

Leakage area

The total area of possible leaks in the completely closed valve. The main purpose of the parameter is to maintain numerical integrity of the circuit by preventing a portion of the system from getting isolated after the valve is completely closed. The parameter value must be greater than 0. The default value is $1e-12 \text{ m}^2$.

Opening dynamics

Select one of the following options:

- **Do not include valve opening dynamics** — The valve sets its orifice passage area directly as a function of pressure. If the area changes instantaneously, so does the flow equation. This is the default.
- **Include valve opening dynamics** — Provide continuous behavior that is more physically realistic, by adding a first-order lag during valve opening and closing. Use this option in hydraulic simulations with the local solver for real-time simulation. This option is also helpful if you are interested in valve opening dynamics in variable step simulations.

Opening time constant

The time constant for the first order response of the valve opening. This parameter is available only if **Opening dynamics** is set to **Include valve opening dynamics**. The default value is 0.1 s.

Initial area at port A

The initial open area for orifice AB. This parameter is available only if **Opening dynamics** is set to **Include valve opening dynamics**. The default value is $1e-4 \text{ m}^2$.

Restricted Parameters

When your model is in Restricted editing mode, you cannot modify the following parameter:

- **Opening dynamics**

All other block parameters are available for modification. The actual set of modifiable block parameters depends on the value of the **Opening dynamics** parameter at the time the model entered Restricted mode.

Global Parameters

Parameters determined by the type of working fluid:

- **Fluid density**
- **Fluid kinematic viscosity**

Use the Hydraulic Fluid block or the Custom Hydraulic Fluid block to specify the fluid properties.

Ports

The block has the following ports:

A

Hydraulic conserving port associated with the valve inlet.

A1

Hydraulic conserving port associated with the valve inlet.

B

Hydraulic conserving port associated with the valve outlet.

Extended Capabilities

C/C++ Code Generation

Generate C and C++ code using Simulink® Coder™.

See Also

Check Valve | Pilot-Operated Check Valve

Topics

“Upgrading Simscape Fluids Models Containing Hydraulics (Isothermal) Blocks”

Introduced in R2006b

Shuttle Valve (IL)

One-way switching valve in an isothermal liquid system

Library: Simscape / Fluids / Isothermal Liquid / Valves & Orifices / Directional Control Valves



Description

The Shuttle Valve (IL) block models a one-way pressure control valve or switching component in an isothermal liquid network. Flow through the valve travels from port **A** or port **A1** to port **B**. When the pressure differential between **A** and **A1**, p_{AA1} , is above a specified threshold pressure, the path between ports **A** and **B** is open to flow and the port at **A1** closes. The path has been fully changed when the pressure reaches the **Pressure at which A-B is fully open and A1-B is fully closed**. When p_{AA1} falls below the threshold pressure, the flow inlet switches to port **A1**.

Mass Flow Rate Equation

Mass is conserved through the valve:

$$\dot{m}_A + \dot{m}_{A1} + \dot{m}_B = 0.$$

There is no flow between ports **A** and **A1**.

The mass flow rate through the valve is calculated as:

$$\dot{m} = \frac{C_d A_{valve} \sqrt{2\bar{\rho}}}{\sqrt{PR_{loss} \left(1 - \left(\frac{A_{valve}}{A_{port}} \right)^2 \right)}} \frac{\Delta p}{[\Delta p^2 + \Delta p_{crit}^2]^{1/4}},$$

where:

- C_d is the **Discharge coefficient**.
- A_{valve} is the valve open area, either between ports **A** and **B** or ports **A1** and **B**.
- A_{port} is the **Cross-sectional area at ports A and B**.
- $\bar{\rho}$ is the average fluid density.
- Δp is the valve pressure difference. Depending on the flow path through the valve, this is either $p_A - p_B$, $p_{A1} - p_B$, or the normalized pressure when switching between the two inlet ports, \hat{p} , defined below.

The critical pressure difference, Δp_{crit} , is the pressure differential associated with the **Critical Reynolds number**, Re_{crit} , and is also dependent on the flow path through the valve:

$$\Delta p_{crit} = \frac{\pi \bar{\rho}}{8 A_{valve}} \left(\frac{\nu Re_{crit}}{C_d} \right)^2.$$

The critical Reynolds number is the flow regime transition point between laminar and turbulent flow.

Pressure loss describes the reduction of pressure in the valve due to a decrease in area, and can change if different valve flow paths have different areas. PR_{loss} is calculated as:

$$PR_{\text{loss}} = \frac{\sqrt{1 - \left(\frac{A_{\text{valve}}}{A_{\text{port}}}\right)^2 (1 - C_d^2)} - C_d \frac{A_{\text{valve}}}{A_{\text{port}}}}{\sqrt{1 - \left(\frac{A_{\text{valve}}}{A_{\text{port}}}\right)^2 (1 - C_d^2)} + C_d \frac{A_{\text{valve}}}{A_{\text{port}}}}.$$

Pressure recovery describes the positive pressure change in the valve due to an increase in area. If you do not wish to capture this increase in pressure, set the **Pressure recovery** to Off. In this case, PR_{loss} is 1.

The opening area, A_{valve} , is also impacted by the valve opening dynamics.

Opening Parameterization

The linear parameterization of the valve area depends on the flow path through the valve. The dynamic area is based on a normally open path between ports **A** and **B**:

$$A_{\text{valve}, AB} = \hat{p}(A_{\text{max}} - A_{\text{leak}}) + A_{\text{leak}}.$$

The normalized pressure, \hat{p} , is

$$\hat{p} = \frac{p_{AA1} - p_{\text{open}, A1B}}{p_{\text{open}, AB} - p_{\text{open}, A1B}},$$

when p_{AA1} is between the parameters **Pressure at which A-B is fully closed and A1-B is fully open** and **Pressure at which A-B is fully open and A1-B is fully closed**. If p_{AA1} is below **Pressure at which A-B is fully closed and A1-B is fully open**, \hat{p} is 0. If p_{AA1} is above **Pressure at which A-B is fully open and A1-B is fully closed**, \hat{p} is 1.

When the valve inlet switches from port **A** to port **A1**, the valve opening area is:

$$A_{\text{valve}, A1B} = A_{\text{max}} + A_{\text{leak}} - A_{\text{valve}, AB}.$$

Opening Dynamics

If opening dynamics are modeled, a lag is introduced to the flow response to the modeled control pressure. p_{control} becomes the dynamic control pressure, p_{dyn} ; otherwise, p_{control} is the steady-state pressure. The instantaneous change in dynamic control pressure is calculated based on the **Opening time constant**, τ :

$$\dot{p}_{\text{dyn}, AB} = \frac{p_{\text{control}} - p_{\text{dyn}, AB}}{\tau}.$$

By default, **Opening dynamics** is set to Off.

Numerically-Smoothed Pressure

At the extremes of the control pressure range, you can maintain numerical robustness in your simulation by adjusting the block **Smoothing factor**. A smoothing function is applied to every calculated control pressure, but primarily influences the simulation at the extremes of this range.

The **Smoothing factor**, s , is applied to the normalized pressure, \hat{p} :

$$\hat{p}_{smoothed} = \frac{1}{2} + \frac{1}{2}\sqrt{\hat{p}^2 + \left(\frac{s}{4}\right)^2} - \frac{1}{2}\sqrt{(\hat{p} - 1)^2 + \left(\frac{s}{4}\right)^2},$$

and the smoothed pressure is:

$$p_{smoothed} = \hat{p}_{smoothed}(p_{max} - p_{set}) + p_{set}.$$

Ports

Conserving

A – Liquid port

isothermal liquid

Entry port to the valve.

A1 – Liquid port

isothermal liquid

Entry port to the valve.

B – Liquid port

isothermal liquid

Exit port from the valve.

Parameters

Pressure at which A-B is fully closed and A1-B is fully open – Threshold pressure for fully open inlet A1

-0.01 MPa (default) | scalar

Pressure threshold between ports **A** and **A1**, below which the flow path between ports **A1** and **B** is fully open and the flow path between ports **A** and **B** is fully closed.

Pressure at which A-B is fully open and A1-B is fully closed – Threshold pressure for fully open inlet A

0.01 MPa (default) | scalar

Pressure threshold between ports **A** and **A1**, above which the flow path between ports **A** and **B** is fully open and the flow path between ports **A1** and **B** is fully closed.

Maximum opening area – Maximum valve area

1e-4 m² (default) | positive scalar

Maximum open area of the valve. This value is used to determine the normalized valve pressure and the valve opening area during operation.

Leakage area – Gap area when in fully closed position

1e-10 m² (default) | positive scalar

Sum of all gaps when the valve is in the fully closed position. Any area smaller than this value is saturated to the specified leakage area. This contributes to numerical stability by maintaining continuity in the flow.

Cross-sectional area at ports A and B – Area at conserving ports

inf m² (default) | positive scalar

Areas at the entry and exit ports **A**, **A1**, and **B**, which are used in the pressure-flow rate equation that determines the mass flow rate through the valve.

Discharge coefficient – Discharge coefficient

0.64 (default) | positive scalar

Correction factor accounting for discharge losses in theoretical flows.

Critical Reynolds number – Upper Reynolds number limit for laminar flow

150 (default) | positive scalar

Upper Reynolds number limit for laminar flow through the orifice.

Smoothing factor – Numerical smoothing factor

0.01 (default) | positive scalar in the range [0,1]

Continuous smoothing factor that introduces a layer of gradual change to the flow response when the valve is in near-open or near-closed positions. Set this value to a nonzero value less than one to increase the stability of your simulation in these regimes.

Pressure recovery – Whether to account for pressure increase in area expansions

Off (default) | On

Whether to account for pressure increase when fluid flows from a region of smaller cross-sectional area to a region of larger cross-sectional area.

Opening dynamics – Whether to introduce flow lag due to valve opening

Off (default) | On

Whether to account for transient effects to the fluid system due to opening the valve. Setting **Opening dynamics** to On approximates the opening conditions by introducing a first-order lag in the flow response. The **Opening time constant** also impacts the modeled opening dynamics.

Opening time constant – Valve opening time constant

0.1 s (default) | positive scalar

Constant that captures the time required for the fluid to reach steady-state conditions when opening or closing the valve from one position to another. This parameter impacts the modeled opening dynamics.

Dependencies

To enable this parameter, set **Opening dynamics** to On.

See Also

Pressure Compensator Valve (IL) | Pressure-Compensated 3-Way Flow Control Valve (IL) | Pilot-Operated Check Valve (IL) | Cartridge Valve Insert (IL)

Introduced in R2020a

Simple Heat Exchanger Interface (G)

Thermal interface between a gas and its surroundings

Library: Simscape / Fluids / Fluid Network Interfaces / Heat Exchangers / Fundamental Components

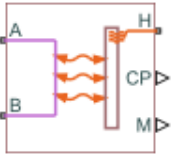

Description

The Simple Heat Exchanger Interface (G) block models the pressure drop and temperature change in a gas as it traverses the length of a thermal interface such as that provided by a heat exchanger. Heat transfer across the thermal interface is ignored. See the composite block diagram of the Heat Exchanger (G-G) block for an example showing how to combine the two blocks.

The pressure drop is calculated as a function of mass flow rate from tabulated data specified at some reference pressure and temperature. The calculation is based on linear interpolation if the mass flow rate is within the bounds of the tabulated data and on nearest-neighbor extrapolation otherwise. In other words, neighboring data points connect through straight-line segments, with those at the mass flow rate bounds extending horizontally outward.

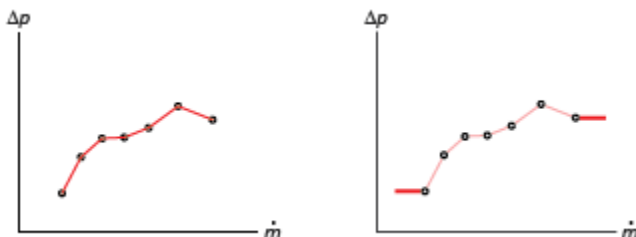

Linear interpolation (left) and nearest-neighbor extrapolation (right)

The block calculations rely on the states and properties of the fluid—temperature, density, and specific internal energy—at the entrance to the thermal interface. The entrance changes abruptly from one port to the other during flow reversal, introducing discontinuities in the values of these variables. To eliminate these discontinuities, the block smooths the affected variables at mass flow rates below a specified threshold value.

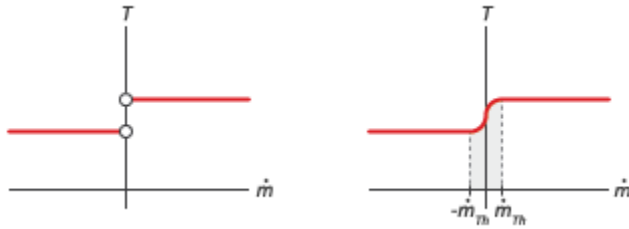

Smoothing of entrance temperature below mass flow rate threshold

Mass Balance

Mass can enter and exit the thermal interface through ports **A** and **B**. The volume of the interface is fixed but the compressibility of the fluid means that the mass inside the interface can change with pressure and temperature. The compressibility of the gas is always taken into account, with its value being that specified in the Gas Properties (G) block dialog box. The mass balance in the interface can then be expressed as:

$$\frac{\partial M}{\partial p} \frac{dp}{dt} + \frac{\partial M}{\partial T} \frac{dT}{dt} = \dot{m}_A + \dot{m}_B,$$

where:

- M is the mass of the internal fluid volume of the thermal interface.
- p is the internal fluid pressure.
- T is the internal fluid temperature.
- \dot{m}_* are the mass flow rates in through the gas ports.

Energy Balance

Energy can enter and exit the thermal interface in two ways: with fluid flow through ports **A** and **B** and with heat flow through port **H**. No work is done on or by the fluid inside the interface. The rate of energy accumulation in the internal fluid volume of the interface must therefore equal the sum of the energy flow rates through all three ports:

$$\frac{\partial E}{\partial p} \frac{dp}{dt} + \frac{\partial E}{\partial T} \frac{dT}{dt} = \phi_A + \phi_B + Q_H,$$

where:

- E is the total energy in the internal fluid volume of the thermal interface.
- ϕ_* are the energy flow rates in through the gas ports.
- Q is the heat flow rate in through the thermal port.

Momentum Balance

The pressure drop calculation is based entirely on tabulated data that you specify. The causes of the pressure drop are ignored, except in the effects that they might have on the specified data. The overall pressure drop from one gas port to the other is calculated from the individual pressure drops from each gas port to the internal fluid volume:

$$p_A - p_B = \Delta p_A - \Delta p_B,$$

where:

- p_* are the fluid pressures at the gas ports.
- Δp_* are the pressure drops from the gas ports to the internal fluid volume:

$$\Delta p_* = p_* - p,$$

with p as the pressure in the internal fluid volume.

The tabulated data is specified at a reference pressure and temperature from which a third reference parameter, the *reference density*, is calculated. The ratio of the reference density to the actual port density serves as a correction factor in the individual pressure drop equations, each defined as:

$$\Delta p_* = \Delta p(\dot{m}_*) \frac{\rho_R}{\rho_*},$$

where:

- $\Delta p(\dot{m})$ is the tabulated pressure drop function.
- ρ_* are the fluid densities at the gas ports.

The asterisk denotes the gas port (**A** or **B**) at which a parameter or variable is defined. Subscript R denotes a reference value. The density at the interface entrance is smoothed below the mass flow rate threshold by introducing a hyperbolic term α :

$$\rho_{*, \text{smooth}} = \rho_* \left(\frac{1 + \alpha}{2} \right) + \rho \left(\frac{1 - \alpha}{2} \right),$$

where ρ_{smooth} is the smoothed density at the entrance port, ρ_* is the unsmoothed density at the same port, and ρ is the density in the internal fluid volume. The hyperbolic smoothing term is defined as:

$$\alpha = \tanh \left(4 \frac{\dot{m}_{\text{avg}}}{\dot{m}_{\text{th}}} \right),$$

where \dot{m}_{avg} is the average of the mass flow rates through the gas ports and \dot{m}_{th} is the mass flow rate threshold specified in the block dialog box. This threshold determines the width of the mass flow rate region over which to smooth the fluid density. The average mass flow rate is defined as:

$$\dot{m}_{\text{avg}} = \frac{\dot{m}_A + \dot{m}_B}{2}$$

Ports

Output

CP — Isobaric specific heat of gas, kJ/(kg*K)

physical signal

Isobaric specific heat of the gas in the internal fluid volume of the thermal interface.

M — Mass flow rate of the thermal liquid, kg/s

physical signal

Mass flow rate of the gas in the internal fluid volume of the interface. The output signal is positive when the flow rate is directed from port **A** to port **B** and negative otherwise.

Conserving

A — Fluid opening

gas

Opening through which gas can enter and exit the thermal interface.

B — Fluid opening

gas

Opening through which gas can enter and exit the thermal interface.

H — Thermal condition at the fluid entrance

thermal

Thermal port used to set the thermal condition at the gas port serving as the gas entrance.

Parameters

Pressure Loss Tab

Mass flow rate vector — Mass flow rates at which to specify pressure-drop data

[.3, .5, 1, 1.5, 2, 2.5] kg/s (default) | *K*-element array with units of mass/time

Array of mass flow rates at which to specify the pressure drop tabulated data.

Pressure drop vector — Pressure-drop data corresponding to specified mass flow rates

[3, 5, 10, 25, 35, 50] * 1e-3 MPa (default) | *K*-element array with units of pressure

Array of pressure drops from inlet to outlet corresponding to the tabulated mass flow rate data.

Reference inflow temperature — Temperature at which pressure-drop data is specified

293.15 K (default) | scalar with units of temperature

Temperature at which the tabulated pressure-drop data is specified.

Reference inflow pressure — Pressure at which pressure-drop tabulated data is specified

0.101325 MPa (default) | scalar with units of pressure

Pressure at which the tabulated pressure-drop data is specified. The block uses this parameter to calculate a third reference parameter, the reference density. The reference that it uses to scale the tabulated pressure drop data for pressures and temperatures deviating from the reference conditions.

Mass flow rate threshold for flow reversal — Mass flow rate below which to smooth numerical data

1e-6 kg/s (default) | scalar with units of mass/time

Mass flow rate below which to initiate a smooth flow reversal to prevent discontinuities in the simulation data.

Gas volume — Volume of gas inside the heat exchanger

0.01 m³ (default) | scalar with units of volume

Volume of gas occupying the heat exchanger at any given time. The initial conditions specified in the **Effects and Initial Conditions** tab apply to this volume. The volume is constant during simulation.

Cross-sectional area at ports A1 and B1 — Flow area at the gas inlets

0.01 m² (default) | scalar with units of area

Flow area at the gas inlets. Inlets **A1** and **B1** are assumed to be identical in size.

Variables Tab**Temperature of gas volume — Temperature of the internal gas volume at the start of simulation**

293.15 K (default) | scalar with units of temperature

Temperature of the internal volume of gas at the start of simulation.

Pressure of gas volume — Pressure of the internal gas volume at the start of simulation

0.101325 MPa (default) | scalar with units of pressure

Pressure of the internal volume of gas at the start of simulation.

Density of gas volume — Density of the internal gas volume at the start of simulation

1.2 kg/m³ (default) | scalar with units of mass/volume

Density of the internal volume of gas at the start of simulation.

Extended Capabilities**C/C++ Code Generation**

Generate C and C++ code using Simulink® Coder™.

See Also

Specific Dissipation Heat Transfer | Simple Heat Exchanger Interface (TL) | Heat Exchanger Interface (G)

Introduced in R2017b

Simple Heat Exchanger Interface (TL)

Thermal interface between a thermal liquid and its surroundings

Library: Simscape / Fluids / Fluid Network Interfaces / Heat Exchangers / Fundamental Components

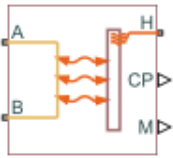

Description

The Simple Heat Exchanger Interface (TL) block models the pressure drop and temperature change in a thermal liquid as it traverses the length of a thermal interface such as that provided by a heat exchanger. Heat transfer across the thermal interface is ignored. See the composite block diagram of the Heat Exchanger (TL-TL) block for an example showing how to combine the two blocks.

The pressure drop is calculated as a function of mass flow rate from tabulated data specified at some reference pressure and temperature. The calculation is based on linear interpolation if the mass flow rate is within the bounds of the tabulated data and on nearest-neighbor extrapolation otherwise. In other words, neighboring data points connect through straight-line segments, with those at the mass flow rate bounds extending horizontally outward.

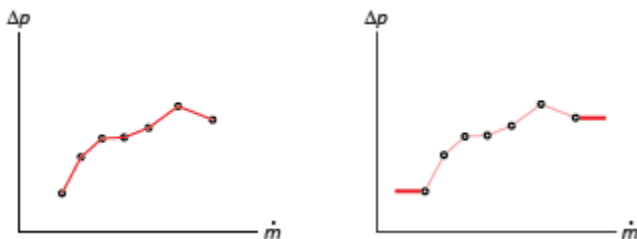

Linear interpolation (left) and nearest-neighbor extrapolation (right)

The block calculations rely on the states and properties of the fluid—temperature, density, and specific internal energy—at the entrance to the thermal interface. The entrance changes abruptly from one port to the other during flow reversal, introducing discontinuities in the values of these variables. To eliminate these discontinuities, the block smooths the affected variables at mass flow rates below a specified threshold value.

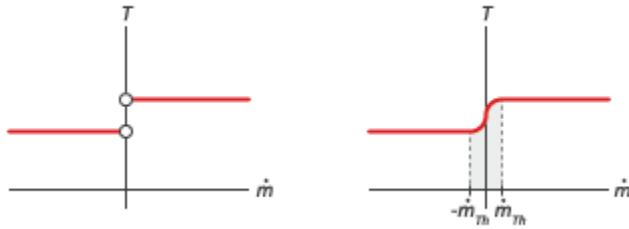

Smoothing of entrance temperature below mass flow rate threshold

Mass Balance

Mass can enter and exit the thermal interface through ports **A** and **B**. The volume of the interface is fixed but the compressibility of the fluid means that the mass inside the interface can change with pressure and temperature. Whether compressibility is factored into the block calculations depends on the setting of the **Thermal Liquid dynamic compressibility** parameter in the **Effects and Initial Conditions** tab:

$$\dot{m}_A + \dot{m}_B = \begin{cases} \left(\frac{dp}{dt} \frac{1}{\beta} - \frac{dT}{dt} \alpha \right) \rho V, & \text{if } ThermalLiquiddynamiccompressibility \text{ is On} \\ 0, & \text{otherwise} \end{cases}$$

where:

- \dot{m}_* are the mass flow rates in through the thermal liquid ports.
- p is the internal fluid pressure.
- T is the internal fluid temperature.
- α is the isobaric thermal expansion coefficient.
- β is the isothermal bulk modulus.
- ρ is the internal fluid density.
- V is the internal fluid volume.

If the **Thermal Liquid dynamic compressibility** parameter is set to **Off**, the fluid is treated as incompressible and the mass flow rate in through one thermal liquid port must exactly equal that out through the other thermal liquid port. The rate of mass accumulation is, in this case, zero.

Energy Balance

Energy can enter and exit the thermal interface in two ways: with fluid flow through ports **A** and **B** and with heat flow through port **H**. No work is done on or by the fluid inside the interface. The rate of energy accumulation in the internal fluid volume of the interface must therefore equal the sum of the energy flow rates through all three ports:

$$\frac{\partial E}{\partial p} \frac{dp}{dt} + \frac{\partial E}{\partial T} \frac{dT}{dt} = \phi_A + \phi_B + Q_H$$

where:

- E is the total energy in the internal fluid volume of the thermal interface.

- ϕ_* are the energy flow rates in through the thermal liquid ports.
- Q is the heat flow rate in through the thermal port.

Momentum Balance

The pressure drop calculation is based entirely on tabulated data that you specify. The causes of the pressure drop are ignored, except in the effects that they might have on the specified data. The overall pressure drop from one thermal liquid port to the other is calculated from the individual pressure drops from each thermal liquid port to the internal fluid volume:

$$p_A - p_B = \Delta p_A - \Delta p_B,$$

where:

- p_* are the fluid pressures at the thermal liquid ports.
- Δp_* are the pressure drops from the thermal liquid ports to the internal fluid volume:

$$\Delta p_* = p_* - p,$$

with p as the pressure in the internal fluid volume.

The tabulated data is specified at a reference pressure and temperature from which a third reference parameter, the *reference density*, is calculated. The ratio of the reference density to the actual port density serves as a correction factor in the individual pressure drop equations, each defined as:

$$\Delta p_* = \Delta p(\dot{m}_*) \frac{\rho_R}{\rho_*},$$

where:

- $\Delta p(\dot{m})$ is the tabulated pressure drop function.
- ρ_* are the fluid densities at the thermal liquid ports.

The asterisk denotes the thermal liquid port (**A** or **B**) at which a parameter or variable is defined. Subscript R denotes a reference value. The density at the interface entrance is smoothed below the mass flow rate threshold by introducing a hyperbolic term α :

$$\rho_{*, \text{smooth}} = \rho_* \left(\frac{1 + \alpha}{2} \right) + \rho \left(\frac{1 - \alpha}{2} \right),$$

where ρ_{smooth} is the smoothed density at the entrance port, ρ_* is the unsmoothed density at the same port, and ρ is the density in the internal fluid volume. The hyperbolic smoothing term is defined as:

$$\alpha = \tanh \left(4 \frac{\dot{m}_{\text{avg}}}{\dot{m}_{\text{th}}} \right),$$

where \dot{m}_{avg} is the average of the mass flow rates through the thermal liquid ports and \dot{m}_{th} is the mass flow rate threshold specified in the block dialog box. This threshold determines the width of the mass flow rate region over which to smooth the fluid density. The average mass flow rate is defined as:

$$\dot{m}_{\text{avg}} = \frac{\dot{m}_A + \dot{m}_B}{2}$$

Ports

Output

CP – Isobaric specific heat of the thermal liquid, kJ/(kg*K)

physical signal

Isobaric specific heat of the thermal liquid in the internal fluid volume of the thermal interface.

M – Mass flow rate of the thermal liquid, kg/s

physical signal

Mass flow rate of the thermal liquid in the interior of the thermal interface. The output signal is positive when the flow rate is directed from port **A** to port **B** and negative otherwise.

Conserving

A – Fluid opening

thermal liquid

Opening through which thermal liquid can enter and exit the thermal interface.

B – Fluid opening

thermal liquid

Opening through which thermal liquid can enter and exit the thermal interface.

H – Thermal condition at the fluid entrance

thermal

Thermal port used to set the thermal condition at the thermal liquid port serving as the thermal liquid entrance.

Parameters

Pressure Loss Tab

Mass flow rate vector – Mass flow rates at which to specify pressure-drop data

[.3, .5, 1, 1.5, 2, 2.5] kg/s (default) | *K*-element array with units of mass/time

Array of mass flow rates at which to specify the pressure drop tabulated data.

Pressure drop vector – Pressure-drop data corresponding to specified mass flow rates

[3, 5, 10, 25, 35, 50] * 1e-3 MPa (default) | *K*-element array with units of pressure

Array of pressure drops from inlet to outlet corresponding to the tabulated mass flow rate data.

Reference inflow temperature – Temperature at which pressure-drop data is specified

293.15 K (default) | scalar with units of temperature

Temperature at which the tabulated pressure-drop data is specified.

Reference inflow pressure – Pressure at which pressure-drop tabulated data is specified

0.101325 MPa (default) | scalar with units of pressure

Pressure at which the tabulated pressure-drop data is specified. The block uses this parameter to calculate a third reference parameter, the reference density. The reference that it uses to scale the tabulated pressure drop data for pressures and temperatures deviating from the reference conditions.

Mass flow rate threshold for flow reversal – Mass flow rate below which to smooth numerical data

1e-6 kg/s (default) | scalar with units of mass/time

Mass flow rate below which to initiate a smooth flow reversal to prevent discontinuities in the simulation data.

Thermal Liquid volume – Volume of thermal liquid inside the heat exchanger

0.01 m³ (default) | scalar with units of volume

Volume of thermal liquid occupying the heat exchanger at any given time. The initial conditions specified in the **Effects and Initial Conditions** tab apply to this volume. The volume is constant during simulation.

Cross-sectional area at ports A1 and B1 – Flow area at the thermal liquid inlets

0.01 m² (default) | scalar with units of area

Flow area at the thermal liquid inlets. Inlets **A1** and **B1** are assumed to be identical in size.

Effects and Initial Conditions

Thermal Liquid dynamic compressibility – Option to model pressure dynamics inside the heat exchanger

On (default) | Off

Option to model the pressure dynamics inside the heat exchanger. Setting this parameter to Off removes the pressure derivative terms from the component energy and mass conservation equations. The pressure inside the heat exchanger is then reduced to the weighted average of the two port pressures.

Thermal Liquid initial temperature – Temperature inside the heat exchanger at the start of simulation

293.15 K (default) | scalar with units of temperature

Temperature of the internal volume of thermal liquid at the start of simulation.

Thermal Liquid initial pressure – Pressure inside the heat exchanger at the start of simulation

0.101325 MPa (default) | scalar with units of pressure

Pressure of the internal volume of thermal liquid at the start of simulation.

Extended Capabilities

C/C++ Code Generation

Generate C and C++ code using Simulink® Coder™.

See Also

Specific Dissipation Heat Transfer | Heat Exchanger Interface (TL) | Simple Heat Exchanger Interface (G) | Heat Exchanger (TL)

Introduced in R2017b

Single-Acting Actuator (TL)

Linear actuator with piston motion controlled by one thermal liquid chamber

Library: Simscape / Fluids / Thermal Liquid / Actuators



Description

The Single-Acting Actuator (TL) block models a linear actuator with piston motion controlled by a single thermal liquid chamber. The actuator generates force in the extension and retraction strokes, but the actuation force depends on the gauge pressure at a single chamber.

The figure shows the key components of the actuator model. Port **A** represents the thermal liquid chamber inlet. Port **R** represents the translating actuator piston and port **C** the actuator case. Port **H** represents the thermal interface between the thermal liquid chamber and the environment.

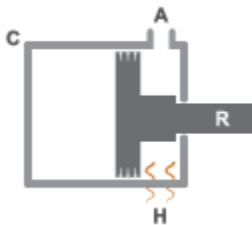

Single-Acting Actuator Schematic

Displacement

The piston displacement is measured as the position at port **R** relative to port **C**. The **Mechanical orientation** identifies the direction of piston displacement. The piston displacement is neutral, or θ , when the chamber volume is equal to the **Dead volume**. When displacement is received as an input, ensure that the derivative of the position is equal to the piston velocity. This is automatically the case when the input is received from a Translational Multibody Interface block connection to a Simscape Multibody joint.

The direction of the piston motion depends on the mechanical orientation setting in the block dialog box. If the mechanical orientation is positive, then a positive gauge pressure at port **A** yields a positive piston translation relative to the actuator case. The direction of motion reverses for a negative mechanical orientation.

Hard Stop

A set of hard stops limit the piston range of motion. The hard stops are treated as spring-damper systems. The spring stiffness coefficient controls the restorative component of the hard-stop contact force and the damping coefficient the dissipative component.

The hard stops are located at the distal ends of the piston stroke. If the mechanical orientation is positive, then the lower hard stop is at $x = 0$ and the upper hard stop at $x = +stroke$. If the

mechanical orientation is negative, then the lower hard stop is at $x = -stroke$ and the upper hard stop is at $x = 0$.

Block Composite

This block is a composite component based on the Simscape Foundation blocks:

- Translational Mechanical Converter (TL)
- Translational Hard Stop
- Ideal Translational Motion Sensor

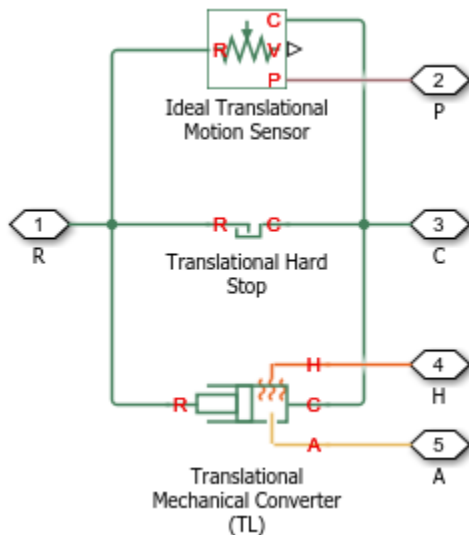

Composite Component Diagram

Ports

- A — Thermal liquid conserving port representing chamber A
- C — Translational conserving port representing the actuator casing
- R — Translational conserving port representing the actuator piston
- H — Thermal conserving port representing the thermal interface between chamber A and the environment
- p — Physical signal input port for the piston position data. To expose this port, set **Piston displacement from chamber A cap** to Provide input signal from Multibody joint.
- p — Physical signal output port for the piston position data. To expose this port, set **Piston displacement from chamber A cap** to Calculate from velocity of port R relative to port C.

Parameters

Actuator Tab

Mechanical orientation

Sets the piston displacement direction. When you set this parameter to:

- Pressure at A causes positive displacement of R relative to C the piston displacement is positive when the volume of liquid at port A is expanding. This corresponds to rod extension.
- Pressure at A causes negative displacement of R relative to C the piston displacement is negative when the volume of liquid at port A is expanding. This corresponds to rod contraction.

The mechanical orientation affects the placement of the actuator hard stops. One hard stop is always at position zero. The second hard stop is at the piston stroke distance if the mechanical orientation is positive and at minus the piston stroke distance if the mechanical orientation is negative.

Piston cross-sectional area

Area normal to the direction of flow in actuator chamber A. The block uses this area to calculate the hydraulic force due to the fluid pressure in chamber A. The piston cross-sectional area must be greater than zero. The default value is 0.01 m^2 .

Piston stroke

Maximum distance the actuator piston can travel. The piston stroke must be greater than zero. The default value is 0.1 m .

Hard stops limit piston motion to the length of the piston stroke. One hard stop is located at position zero. The second hard stop is at the piston stroke distance if **Mechanical Orientation** is set to Pressure at A causes positive displacement of R relative to C and at minus the piston stroke if **Mechanical Orientation** is set to Pressure at A causes negative displacement of R relative to C.

Dead volume

Volume of liquid when the piston displacement is 0. This is the liquid volume when the piston is up against the actuator end cap. The default value is $1\text{e-}5 \text{ m}^3$.

Environment pressure specification

Choice of environment pressure. Options include Atmospheric pressure and Specified pressure. Selecting Specified pressure exposes an additional parameter, **Environment pressure**.

Environment pressure

Pressure outside the actuator casing. This pressure acts against the pressures inside the actuator chamber. A value of zero corresponds to a vacuum. The default value is 0.101325 MPa . This parameter is visible only when **Environment pressure specification** is set to Specified pressure.

Hard Stop Tab

Hard-stop stiffness coefficient

Spring coefficient of the actuator hard stops. The spring coefficient accounts for the restorative portion of the hard-stop contact force. Increase the coefficient value to model harder contact. The default value is $1e10$ N/m.

Hard-stop damping coefficient

Damping coefficient of the actuator hard stops. The damping coefficient accounts for the dissipative portion of the hard-stop contact force. Increase the coefficient value to reduce bounce upon contact. The default value is 150 N/(m/s).

Hard stop model

Modeling approach for hard stops. Options include:

- **Stiffness and damping applied smoothly through transition region (default)** — Scale the magnitude of the contact force from zero to its full value over a specified transition length. The scaling is polynomial in nature. The polynomial scaling function is numerically smooth and it produces no zero crossings of any kind.
- **Full stiffness and damping applied at bounds, undamped rebound** — Apply the full value of the calculated contact force when the hard-stop location is breached. The contact force is a mix of spring and damping forces during penetration and a spring force—without a damping component—during rebound. No smoothing is applied.
- **Full stiffness and damping applied at bounds, damped rebound** — Apply the full value of the calculated contact force when the hard-stop location is breached. The contact force is a mix of spring and damping forces during both penetration and rebound. No smoothing is applied. This is the hard-stop model used in previous releases.

Transition region

Distance below which scaling is applied to the hard-stop force. The contact force is zero when the distance to the hard stop is equal to the value specified here. It is at its full value when the distance to the hard stop is zero. The default value is 1 mm.

Initial Conditions Tab

Piston displacement from chamber A cap

Method for determining the piston position. The block can receive the position from a Multibody block when set to **Provide input signal from Multibody joint**. The default value is **Calculate from velocity of port R relative to port C**.

Initial piston displacement

Piston position at the start of simulation. This value must be between zero and the piston stroke if the **Mechanical orientation** parameter is set to **Pressure at A causes positive displacement of R relative to C**. It must be between zero and minus the piston stroke if the **Mechanical orientation** parameter is set to **Pressure at A causes negative displacement of R relative to C**. The default value is 0 m. To enable this parameter, set **Piston displacement from chamber A cap** to **Calculate from velocity of port R relative to port C**.

Initial liquid temperature

Temperature in actuator chamber A at the start of simulation. The default value is 293.15 K.

Fluid dynamic compressibility

Option to model effects due to fluid dynamic compressibility. Select `On` to enable fluid dynamic compressibility and `Off` to disable it.

Initial liquid pressure

Pressure in actuator chamber A at the start of simulation. The default value is `0.101325` MPa.

Extended Capabilities

C/C++ Code Generation

Generate C and C++ code using Simulink® Coder™.

See Also

Double-Acting Actuator (TL)

Topics

“Connecting Simscape Networks to Simscape Multibody Joints”

Introduced in R2016a

Single-Acting Hydraulic Cylinder

Hydraulic actuator exerting force in one direction



Library

Hydraulic Cylinders

Description

The Single-Acting Hydraulic Cylinder block models a device that converts hydraulic energy into mechanical energy in the form of translational motion. Hydraulic fluid pumped under pressure into the cylinder chamber forces the piston to move and exert force on the cylinder rod. Single-acting cylinders transfer force and motion in one direction only. Use an external device, such as a spring, weight, or another opposite installed cylinder, to move the rod in the opposite direction.

Ports **R** and **C** are mechanical translational conserving ports corresponding to the cylinder rod and cylinder clamping structure, respectively. Port **A** is a hydraulic conserving port associated with the cylinder inlet.

The energy through port **A** is directed to the Translational Hydro-Mechanical Converter block. The converter transforms hydraulic energy into mechanical energy and accounts for the fluid compressibility in the cylinder chamber. The rod motion is limited with the mechanical Translational Hard Stop block in such a way that the rod can travel only between cylinder caps. The piston position is conveyed to the physical signal port **p**.

Displacement

The piston displacement is measured as the position at port **R** relative to port **C**. The **Cylinder orientation** identifies the direction of piston displacement. The piston displacement is neutral, or θ , when the chamber volume is equal to the chamber dead volume. When displacement is received as an input, ensure that the derivative of the position is equal to the piston velocity. This is automatically the case when the input is received from a Translational Multibody Interface block connection to a Simscape Multibody joint.

When displacement is set by the cylinder, it is calculated as:

$$x_{\text{pst}} = x_0 + x_p \quad (1-11)$$

where

x_{pst}	Rod displacement output by the physical signal port
x_0	Initial distance between piston and cap
x_p	Rod displacement with respect to its initial position

Composite Structure

The model of the cylinder is built of Simscape Foundation library blocks. The schematic diagram of the model is shown below.

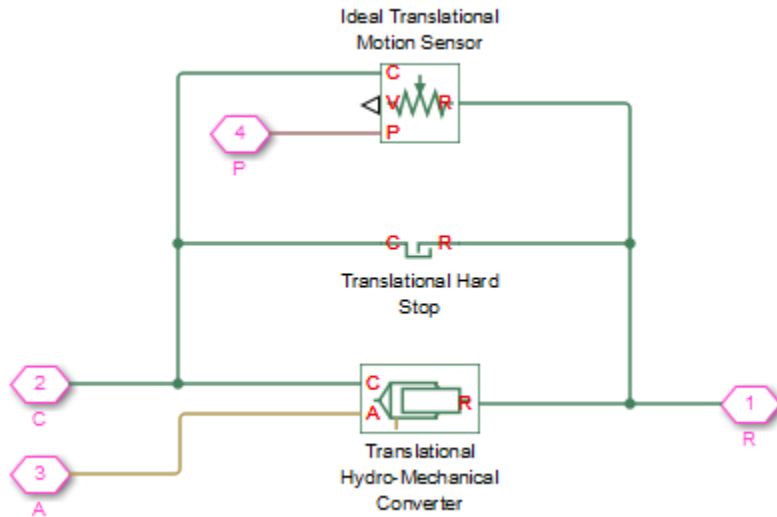

Basic Assumptions and Limitations

- No leakage, internal or external, is taken into account.
- No loading on piston rod, such as inertia, friction, spring, and so on, is taken into account. If necessary, you can easily add them by connecting an appropriate building block to cylinder port R.

Parameters

Piston area

Effective piston area. The default value is 0.001 m^2 .

Piston stroke

Piston maximum travel between caps. The default value is 0.1 m .

Piston displacement

Method for determining the piston position. The default value is `Calculate from velocity of port R relative to port C`, which calculates the position internally and reports the position at port **p**. The block can also receive the position at port **p** from a Multibody block when set to `Provide input signal from Multibody joint`.

Initial distance between piston and cap

The distance between the piston and cap at the beginning of simulation. This value cannot exceed the piston stroke. The default value is 0 , which corresponds to the fully retracted position. To enable this parameter, set **Piston displacement** to `Calculate from velocity of port R relative to port C`.

Dead volume

Fluid volume that remains in the chamber after the rod is fully retracted. The default value is $1e-4 \text{ m}^3$.

Chamber initial pressure

Pressure in the cylinder chamber at the beginning of simulation. The default value is 0.

Specific heat ratio

Gas-specific heat ratio for the Hydraulic Piston Chamber block. The default value is 1.4.

Contact stiffness

Specifies the elastic property of colliding bodies for the Translational Hard Stop block. The greater the value of the parameter, the less the bodies penetrate into each other, the more rigid the impact becomes. Lesser value of the parameter makes contact softer, but generally improves convergence and computational efficiency. The default value is $1e6$ N/m.

Contact damping

Specifies dissipating property of colliding bodies for the Translational Hard Stop block. At zero damping, the impact is close to an absolutely elastic one. The greater the value of the parameter, the more energy dissipates during an interaction. Keep in mind that damping affects slider motion as long as the slider is in contact with the stop, including the period when slider is pulled back from the contact. For computational efficiency and convergence reasons, MathWorks recommends that you assign a nonzero value to this parameter. The default value is 150 N*s/m.

Hard stop model

Modeling approach for hard stops. Options include:

- **Stiffness and damping applied smoothly through transition region (default)** — Scale the magnitude of the contact force from zero to its full value over a specified transition length. The scaling is polynomial in nature. The polynomial scaling function is numerically smooth and it produces no zero crossings of any kind.
- **Full stiffness and damping applied at bounds, undamped rebound** — Apply the full value of the calculated contact force when the hard-stop location is breached. The contact force is a mix of spring and damping forces during penetration and a spring force—without a damping component—during rebound. No smoothing is applied.
- **Full stiffness and damping applied at bounds, damped rebound** — Apply the full value of the calculated contact force when the hard-stop location is breached. The contact force is a mix of spring and damping forces during both penetration and rebound. No smoothing is applied. This is the hard-stop model used in previous releases.

Transition region

Distance below which scaling is applied to the hard-stop force. The contact force is zero when the distance to the hard stop is equal to the value specified here. It is at its full value when the distance to the hard stop is zero. The default value is 1 mm.

Cylinder orientation

Specifies cylinder orientation with respect to the globally assigned positive direction. The cylinder can be installed in two different ways, depending upon whether it exerts force in the positive or in the negative direction when pressure is applied at its inlet. If pressure applied at port A exerts force in negative direction, set the parameter to **Pressure at A causes negative displacement of R relative to C**. The default value is **Pressure at A causes positive displacement of R relative to C**.

Restricted Parameters

When your model is in Restricted editing mode, you cannot modify the following parameter:

- **Cylinder orientation**

All other block parameters are available for modification.

Global Parameters

Parameter determined by the type of working fluid:

- **Fluid bulk modulus**

Use the Hydraulic Fluid block or the Custom Hydraulic Fluid block to specify the fluid properties.

Ports

The block has the following ports:

A

Hydraulic conserving port associated with the cylinder inlet.

R

Mechanical translational conserving port associated with the cylinder rod.

C

Mechanical translational conserving port associated with the cylinder clamping structure.

p

Physical signal input port that receives rod extension from a Multibody block. To expose this port, set **Piston displacement** to Provide input signal from Multibody joint.

p

Physical signal output port that returns the rod position with respect to port C. To expose this port, set **Piston displacement** to Calculate from velocity of port R relative to port C.

Extended Capabilities

C/C++ Code Generation

Generate C and C++ code using Simulink® Coder™.

See Also

Single-Acting Hydraulic Cylinder (Simple) | Double-Acting Hydraulic Cylinder | Ideal Translational Motion Sensor | Translational Hard Stop | Translational Hydro-Mechanical Converter

Topics

“Upgrading Simscape Fluids Models Containing Hydraulics (Isothermal) Blocks”

Introduced in R2006a

Single-Acting Actuator (IL)

Linear conversion of pressure to actuation in an isothermal liquid system

Library: Simscape / Fluids / Isothermal Liquid / Actuators



Description

The Single-Acting Actuator (IL) block represents an actuator that converts the liquid pressure at port **A** into a mechanical force at port **R** via an extending-retracting piston. The piston motion is limited by a hard stop model. When the piston position is calculated internally, it is reported at port **p**, and when the position is set by a connection to a Simscape Multibody joint, it is received as a physical signal at port **p**.

The **Initial piston displacement**, **Fluid dynamic compressibility**, and reference environmental pressure can be modified. Fluid and mechanical inertia are not modeled.

Displacement

The piston displacement is measured as the position at port **R** relative to port **C**. The **Mechanical orientation** identifies the direction of piston displacement. The piston displacement is neutral, or θ , when the chamber volume is equal to the **Dead volume**. When displacement is received as an input, ensure that the derivative of the position is equal to the piston velocity. This is automatically the case when the input is received from a Translational Multibody Interface block connection to a Simscape Multibody joint.

Hard Stop Model

Three models are available to model the extension limit of the actuator piston. This block uses a similar formulation as the Translational Hard Stop block and models uniform damping and stiffness coefficients at both ends of the piston stroke. For more information on the hard stop model options, see the Translational Hard Stop block.

The hard stop force is modeled when the piston is at its upper or lower bound. The boundary region is within the **Transition region** of the **Piston stroke** or **Piston initial displacement**. Outside of this region, $F_{HardStop} = 0$.

Cushion

You can optionally model cushioning toward the extremes of the piston stroke. Setting **Cylinder end cushioning** to On slows the piston motion as it approaches its maximum extension, which is defined in **Piston stroke**. For more information on the functionality of a cylinder cushion, see the Cylinder Cushion (IL) block.

Friction

You can optionally model friction against piston motion. When **Cylinder friction** is set to On, the resulting friction is a combination of Stribeck, Coulomb, and viscous effects. The pressure difference is measured between the chamber pressure and the environment pressure. For more information on the friction model and its limitations, see the Cylinder Friction block.

Leakage

You can optionally model leakage between the liquid chamber and the piston reservoir. When **Leakage** is set to **On**, Poiseuille flow is modeled between the piston and cylinder. This block uses the Simscape Foundation Library Laminar Leakage (IL) block. The flow rate is calculated as:

$$\dot{m} = \frac{\frac{\pi}{128} \left(d_0^4 - d_i^4 - \frac{(d_0^2 - d_i^2)^2}{\log(d_0/d_i)} \right)}{\nu L} (p_A - p_{env}),$$

where:

- ν is the fluid kinematic viscosity.
- L is the piston length, $\mathbf{p} - P_0$.
- p_A is the pressure at port **A**.
- p_{env} is the environmental pressure, which is selected in the **Environment pressure specification** parameter.

The cylinder diameter, d_0 , is $d_0 = d_i + 2c$, where c is the **Piston-cylinder clearance**, and the piston diameter, d_i , is $d_i = \sqrt{\frac{4A_P}{\pi}}$, where A_P is the **Piston cross-sectional area**.

Numerically-Smoothed Area and Pressure

At the extremes of the cushion orifice area and check valve pressure range, you can maintain numerical robustness in your simulation by adjusting the block **Smoothing factor**. A smoothing function is applied to all calculated areas and valve pressures, but primarily influences the simulation at the extremes of these ranges.

The normalized orifice area is calculated as:

$$\widehat{A} = \frac{(A - A_{leak})}{(A_{max} - A_{leak})}.$$

where:

- A_{leak} is the cushion **Leakage area between plunger and cushion sleeve**.
- A_{max} is the **Cushion plunger cross-sectional area**.

The **Smoothing factor**, f , is applied to the normalized area:

$$\widehat{A}_{smoothed} = \frac{1}{2} + \frac{1}{2} \sqrt{\widehat{A}^2 + \left(\frac{f}{4}\right)^2} - \frac{1}{2} \sqrt{(\widehat{A} - 1)^2 + \left(\frac{f}{4}\right)^2}.$$

The smoothed orifice area is:

$$A_{smoothed} = \widehat{A}_{smoothed}(A_{max} - A_{leak}) + A_{leak}.$$

Similarly, the normalized valve pressure is:

$$\widehat{p} = \frac{(p - p_{cracking})}{(p_{max} - p_{cracking})}.$$

where:

- $p_{cracking}$ is the cushion **Check valve cracking pressure differential**.
- p_{max} is the cushion **Check valve maximum pressure differential**.

Smoothing applied to the normalized pressure is:

$$\widehat{p}_{smoothed} = \frac{1}{2} + \frac{1}{2} \sqrt{\widehat{p}^2 + \left(\frac{f}{4}\right)^2} - \frac{1}{2} \sqrt{(\widehat{p} - 1)^2 + \left(\frac{f}{4}\right)^2},$$

and the smoothed pressure is:

$$p_{smoothed} = \widehat{p}_{smoothed}(p_{max} - p_{cracking}) + p_{cracking}.$$

Block Sub-Components

The Single-Acting Actuator (IL) block comprises four Simscape Foundation and two Fluids Library blocks:

- Translational Hard Stop
- Laminar Leakage (IL)
- Converter
- Sensor
- Cylinder Cushion (IL)
- Cylinder Friction (IL)

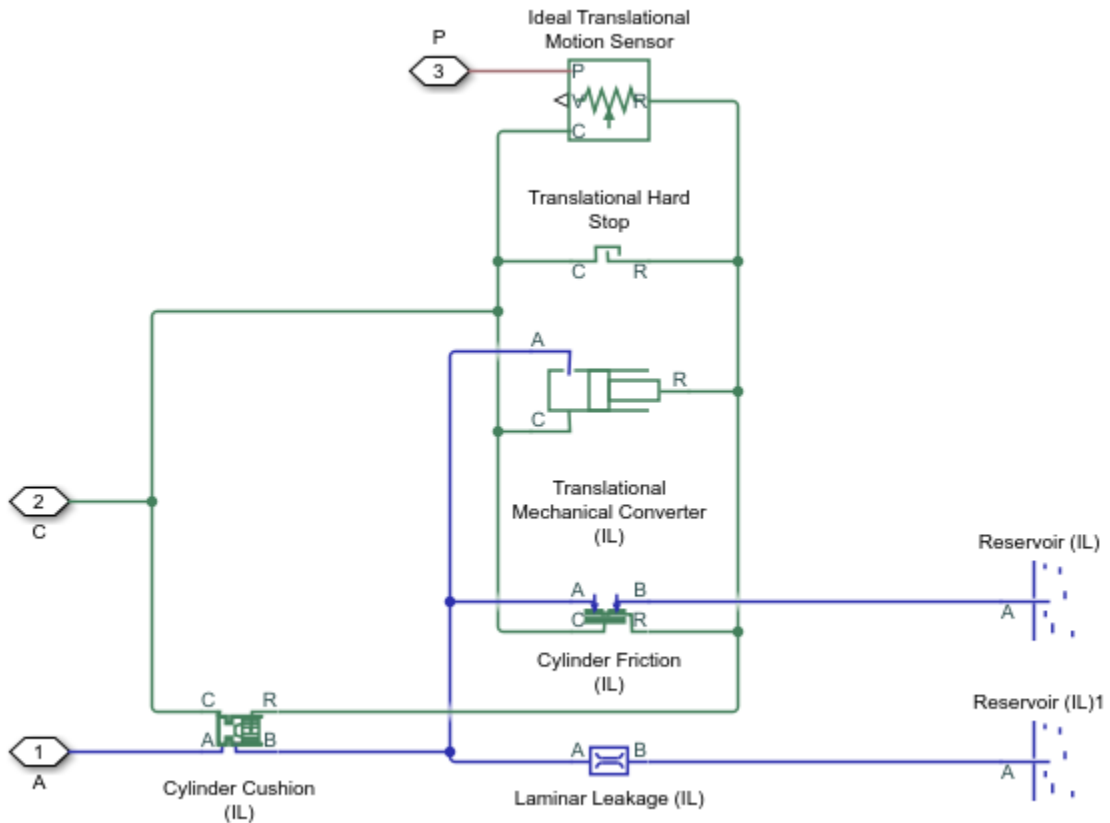

Actuator Structural Diagram

Ports

Conserving

A – Liquid port

isothermal liquid

Liquid entry point to the actuator chamber.

C – Actuator casing

mechanical translational

Reference port for actuator velocity and force.

R – Actuator piston

mechanical translational

Port associated with the piston velocity and force.

Input**p — Piston position, m**

physical signal

Piston position in m, received as a physical signal from a Simscape Multibody block.

Dependencies

To expose this port, set **Piston displacement** to Provide input signal from Multibody joint.

Output**p — Piston position, m**

physical signal

Piston position in m, returned as a physical signal.

Dependencies

To expose this port, set **Piston displacement** to Calculate from velocity of port R relative to port C.

Parameters**Actuator****Mechanical orientation — Piston displacement direction**

Pressure at A causes positive displacement of R relative to C (default) | Pressure at A causes negative displacement of R relative to C

Sets the piston displacement direction. When you set this parameter to:

- Pressure at A causes positive displacement of R relative to C the piston displacement is positive when the volume of liquid at port **A** is expanding. This corresponds to rod extension.
- Pressure at A causes negative displacement of R relative to C the piston displacement is negative when the volume of liquid at port **A** is expanding. This corresponds to rod contraction.

Piston cross-sectional area — Cross-sectional area of piston rod

0.01 m² (default) | positive scalar

Cross-sectional area of the piston rod.

Piston stroke — Maximum piston travel distance

0.1 m (default) | positive scalar

Maximum piston travel distance.

Dead volume — Fluid volume at full piston retraction

1e-5 m³ (default) | positive scalar

Volume of liquid when the piston displacement is 0. This is the liquid volume when the piston is up against the actuator end cap.

Environment pressure — User-defined environmental pressure

0.101325 MPa (default) | positive scalar

User-defined environmental pressure.

Dependencies

To enable this parameter, set **Environment pressure specification** to Specified pressure.

Environment pressure specification — Reference environment pressure

Atmospheric pressure (default) | Specified pressure

Environment reference pressure. The Atmospheric pressure option sets the environmental pressure to 0.101325 MPa.

Hard Stop**Hard-stop stiffness coefficient — Stiffness coefficient**

1e10 N/m (default) | positive scalar

Piston stiffness coefficient.

Hard-stop damping coefficient — Damping coefficient

150 N/(m/s) (default) | positive scalar

Piston stiffness coefficient. This value must be greater than 0.

Hard stop model — Model choice for force on piston at full extension or retraction

Stiffness and damping applied smoothly through transition region, damped rebound (default) | Full stiffness and damping applied at bounds, undamped rebound | Full stiffness and damping applied at bounds, damped rebound

Model choice for the force on the piston at full extension or full retraction. See the Translational Hard Stop block for more information.

Transition region — Application range of hard stop force model

0.1 mm (default) | positive scalar

Application range of the hard stop force model. Outside of this range of the piston maximum extension and piston maximum retraction, the **Hard stop model** is not applied and there is no additional force on the piston.

Dependencies

To enable this parameter, set **Hard stop model** to Stiffness and damping applied smoothly through transition region, damped rebound.

Cushion**Cylinder end cushioning — Whether to model piston slow-down at maximum extension**

Off (default) | On

Whether to model piston slow-down at maximum extension. See the Cylinder Cushion (IL) block for more information.

Cushion plunger cross-sectional area — Cylinder cushion plunger area

1e-4 m² (default) | positive scalar

Area of the plunger inside the actuator cushion element.

Dependencies

To enable this parameter, set **Cylinder end cushioning** to 0n.

Cushion plunger length — Length of cushion plunger

1e-3 m (default) | positive scalar

Length of the cushion plunger.

Dependencies

To enable this parameter, set **Cylinder end cushioning** to 0n.

Cushion orifice area — Area of orifice between cushion chambers

1e-6 m² (default) | positive scalar

Area of the orifice between cushion chambers.

Dependencies

To enable this parameter, set **Cylinder end cushioning** to 0n.

Leakage area between plunger and cushion sleeve — Gap between cushion plunger and sleeve

1e-7 m² (default) | positive scalar

Gap area between the cushion plunger and sleeve. This value contributes to numerical stability by maintaining continuity in the flow.

Dependencies

To enable this parameter, set **Cylinder end cushioning** to 0n.

Check valve cracking pressure differential — Cushion threshold pressure

0.01 MPa (default) | positive scalar

Pressure beyond which the valve operation is triggered. When the pressure difference between port **A** and P_{env} meets or exceeds the **Check valve cracking pressure differential**, the cushion valve begins to open.

Dependencies

To enable this parameter, set **Cylinder end cushioning** to 0n.

Check valve maximum pressure differential — Cushion differential pressure maximum

0.1 MPa (default) | positive scalar

Maximum cushion valve differential pressure. This parameter provides an upper limit to the pressure so that system pressures remain realistic.

Dependencies

To enable this parameter, set **Cylinder end cushioning** to 0n.

Check valve maximum area — Area of fully opened cushion valve

1e-4 m² (default) | positive scalar

Cross-sectional area of the cushion valve in its fully open position.

Dependencies

To enable this parameter, set **Cylinder end cushioning** to On.

Check valve leakage area — Cushion valve gap area when in fully closed position

1e-10 m² (default) | positive scalar

Sum of all gaps when the cushion check valve is in a fully closed position. Any area smaller than this value is saturated to the specified leakage area. This value contributes to numerical stability by maintaining continuity in the flow.

Dependencies

To enable this parameter, set **Cylinder end cushioning** to On.

Smoothing factor — Numerical smoothing factor

0.01 (default) | positive scalar

Continuous smoothing factor that introduces a layer of gradual change to the flow response when the variable orifice and check valve are in near-open or near-closed positions. Set this value to a nonzero value less than one to increase the stability of your simulation in these regimes.

Dependencies

To enable this parameter, set **Cylinder end cushioning** to On.

Friction**Cylinder friction — Whether to model friction against piston motion**

Off (default) | On

Whether to model friction against piston motion. The model accounts for Coulomb, Stribeck, and viscous friction. See the Cylinder Friction block for more information.

Breakaway to Coulomb friction force ratio — Ratio of breakaway force to Coulomb friction force

1.2 (default) | positive scalar

Ratio of the breakaway force to the Coulomb friction force.

Dependencies

To enable this parameter, set **Cylinder friction** to On.

Breakaway friction velocity — Threshold for motion

0.1 m/s (default) | positive scalar

Threshold velocity for motion against friction force to begin.

Dependencies

To enable this parameter, in the **Friction** tab, set **Cylinder friction** to On.

Preload force — Initial force in cylinder due to seal assembly

20 N (default) | scalar

Initial force in the cylinder due to seal assembly.

Dependencies

To enable this parameter, set **Cylinder friction** to On.

Coulomb friction force coefficient – Coulomb friction force coefficient

1e-6 N/Pa (default) | positive scalar

Coulomb force coefficient of friction.

Dependencies

To enable this parameter, set **Cylinder friction** to On.

Viscous friction coefficient – Viscous friction coefficient

100 N/(m/s) (default) | positive scalar

Viscous friction coefficient.

Dependencies

To enable this parameter, set **Cylinder friction** to On.

Leakage

Leakage – Whether to model annular leakage

Off (default) | On

Whether to model annular leakage between the fluid chamber and the piston reservoir at reference environment conditions. The leakage is considered laminar. See the Laminar Leakage (IL) block for more information.

Piston-cylinder clearance – Radial clearance

1e-4 m (default) | positive scalar

Radial distance between the piston rod and cylinder casing.

Dependencies

To enable this parameter, set **Leakage** to On.

Piston head length – Annular length of piston mounting

0.01 m (default) | positive scalar

Annular length of the piston mounting, not including the piston rod.

Dependencies

To enable this parameter, set **Leakage** to On.

Initial conditions

Piston displacement – Method for determining piston position

Calculate from velocity of port R relative to port C (default) | Provide input signal from Multibody joint

Method for determining the piston position. The block can receive the position from a Multibody block when set to Provide input signal from Multibody joint, or calculates the position

internally and reports the position at port **p**. The position is between 0 and the **Piston stroke** when the mechanical orientation is positive and 0 and **-Piston stroke** when the mechanical orientation is negative.

Initial piston displacement – Piston position at start of simulation

0 m (default) | scalar

Piston position at the start of the simulation.

Dependencies

To enable this parameter, set **Piston displacement** to Calculate from velocity of port R relative to port C.

Fluid dynamic compressibility – Whether to model fluid compressibility

On (default) | Off

Whether to model any change in fluid density due to fluid compressibility. When **Fluid compressibility** is set to On, changes due to the mass flow rate into the block are calculated in addition to density changes due to changes in pressure. In the Isothermal Liquid Library, all blocks calculate density as a function of pressure.

Initial liquid pressure – Starting liquid pressure for compressible fluids

0.101325 MPa (default) | positive scalar

Starting liquid pressure for compressible fluids.

Dependencies

To enable this parameter, set **Fluid dynamic compressibility** to On.

See Also

Rotating Single-Acting Actuator (IL) | Single-Acting Rotary Actuator (IL) | Pilot Valve Actuator (IL) | Double-Acting Actuator (IL) | Double-Acting Actuator (G-IL)

Topics

“Connecting Simscape Networks to Simscape Multibody Joints”

Introduced in R2020a

Single-Acting Hydraulic Cylinder (Simple)

Basic functionality of single-acting hydraulic cylinder



Library

Hydraulic Cylinders

Description

The Single-Acting Hydraulic Cylinder (Simple) block represents a simplified version of a hydraulic cylinder, developed for applications where only the basic cylinder functionality must be reproduced, in exchange for better numerical efficiency. For these reasons, such factors as fluid compressibility, friction, and leakages are assumed to be negligible. The hard stops are assumed to be fully inelastic, to eliminate any possible oscillations at the end of the stroke. The model is especially suitable for real-time and HIL (hardware-in-the-loop) simulation, if such simplifications are acceptable.

The model is described with the following equations:

$$F = A \cdot p - F_c$$

$$q = A \cdot v$$

$$\frac{dx}{dt} = v$$

$$v = v_R - v_C$$

$$F_c = \begin{cases} (x - x_E) \cdot K_p \cdot v & \text{if } x > x_E, v > 0 \\ (x - x_R) \cdot K_p \cdot v & \text{if } x < x_R, v < 0 \\ 0 & \text{otherwise} \end{cases}$$

$$x_E = S - x_0$$

$$x_R = -x_0$$

where

F	Force developed by the cylinder
v	Cylinder rod velocity
v_R, v_C	Absolute velocities of cylinder rod and cylinder case, respectively
A	Piston area
p	Pressure at the cylinder inlet

q	Flow rate at the cylinder inlet
x	Piston position
x_0	Initial distance between piston and the cap
F_c	Hard stop force
x_E	Distance the piston can travel to fully extend from initial position
x_R	Distance the piston can travel to fully retract from initial position
K_p	Penetration coefficient
S	Piston stroke

The main difference between this block and the Single-Acting Hydraulic Cylinder block is the representation of the hard stop:

- The Single-Acting Hydraulic Cylinder block utilizes the elastic model of the stop, which is essentially a combination of a spring and a damper, connected in parallel. The stiffness of the spring, which represents contact stiffness of colliding bodies, is very high, resulting in high-frequency, low-magnitude oscillations at the moment the bodies collide. These oscillations can hardly be noticed experimentally, but they are difficult to process by a numerical simulation and generally decrease numerical efficiency.
- The hard stop in the Single-Acting Hydraulic Cylinder (Simple) block is represented with the inelastic model, which is essentially a viscous damper with the penetration-dependent damping coefficient. This coefficient is referred to as the penetration coefficient. With inelastic model, no oscillation is generated during an impact, resulting in improved numerical robustness and efficiency. But inelastic stop model has a feature that you must consider while selecting the model: colliding bodies continue slowly moving into each other as long as the contact is loaded with the compressing force. In real life, this phenomenon is similar to collision of two bodies separated by a sizable layer of viscous liquid. It takes some time to squeeze the liquid before bodies themselves come into contact.

Connections R and C are mechanical translational conserving ports corresponding to the cylinder rod and cylinder clamping structure, respectively. Connection A is a hydraulic conserving port associated with the cylinder inlet. The physical signal output port P shows current rod extension.

Pressure at port A generates force in the direction specified by the **Cylinder orientation** parameter.

Basic Assumptions and Limitations

- Friction between moving parts is not taken into account.
- Inertia effects are not taken into account.
- Fluid compressibility is not taken into account.
- Leakage flows are assumed to be negligible.
- The hard stops are assumed to be fully inelastic, as explained above.

Parameters

Piston area

Effective piston area. The default value is $5e-4 \text{ m}^2$.

Piston stroke

Piston maximum travel between caps. The default value is 0.1 m.

Initial distance between piston and cap

The distance between the piston and cap at the beginning of simulation. This value cannot exceed the piston stroke. The default value is 0, which corresponds to the fully retracted position.

Penetration coefficient

Specifies the penetration property of colliding bodies. The higher the value of the coefficient, the less the bodies penetrate into each other, but the sharper the increase of the impact force. To find out the value of the coefficient for a particular application, it is recommended to run the same model with different hard stop models (or with different cylinder models) until they show close results. The default value of the coefficient is $1e12$ N/m/(m/s).

Cylinder orientation

Specifies cylinder orientation with respect to the globally assigned positive direction. The cylinder can be installed in two different ways, depending upon whether it exerts force in the positive or in the negative direction when pressure is applied at its inlet. If pressure applied at port A exerts force in negative direction, set the parameter to `Acts in negative direction`. The default value is `Acts in positive direction`.

Restricted Parameters

When your model is in Restricted editing mode, you cannot modify the following parameter:

- **Cylinder orientation**

All other block parameters are available for modification.

Ports

The block has the following ports:

A

Hydraulic conserving port associated with the cylinder inlet.

R

Mechanical translational conserving port associated with the cylinder rod.

C

Mechanical translational conserving port associated with the cylinder clamping structure.

P

Physical signal output port that outputs rod extension.

Extended Capabilities**C/C++ Code Generation**

Generate C and C++ code using Simulink® Coder™.

See Also

Double-Acting Hydraulic Cylinder | Double-Acting Hydraulic Cylinder (Simple) | Single-Acting Hydraulic Cylinder | Translational Hard Stop | Translational Hydro-Mechanical Converter

Topics

“Upgrading Simscape Fluids Models Containing Hydraulics (Isothermal) Blocks”

Introduced in R2010a

Single-Acting Rotary Actuator (IL)

Double-acting rotary actuator in an isothermal liquid system

Library: Simscape / Fluids / Isothermal Liquid / Actuators

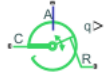

Description

The Single-Acting Rotary Actuator (IL) block models a rotary actuator that converts liquid pressure into mechanical torque in an isothermal liquid network. The motion of the piston when it is near full extension or full retraction is limited by one of three hard stop models.

Port **A** is the isothermal liquid conserving port associated with inlet of the liquid chamber. Ports **R** and **C** are the mechanical rotational conserving ports associated with the rotating shaft and the actuator casing, respectively. If **Mechanical orientation** is set to **Pressure at A causes positive rotation of R relative to C**, the pressure in the liquid chamber causes a positive rotation of the shaft at port **R** relative to port **C**. When the shaft angle is calculated internally, the physical signal port **q** reports the angle. When the angle is set by a connection to a Simscape Multibody joint, it is received as a physical signal at port **q**.

Displacement

The piston displacement is measured as the position at port **R** relative to port **C**. The **Mechanical orientation** identifies the direction of piston displacement. The piston displacement is neutral, or Θ , when the chamber volume is equal to the **Dead volume**. When displacement is received as an input, ensure that the derivative of the position is equal to the piston velocity. This is automatically the case when the input is received from a Rotational Multibody Interface block connection to a Simscape Multibody joint.

Hard Stop Model

To avoid mechanical damage to an actuator when it is fully extended or fully retracted, an actuator typically displays nonlinear behavior when the piston approaches these limits. The Single-Acting Rotary Actuator (IL) block models this behavior with a choice of three hard stop models, which model the material compliance through a spring-damper system. The hard stop models are:

- Stiffness and damping applied smoothly through transition region, damped rebound.
- Full stiffness and damping applied at bounds, undamped rebound.
- Full stiffness and damping applied at bounds, damped rebound.

The hard stop force is modeled when the piston is at its upper or lower bound. The boundary region is within the **Transition region** of the **Stroke** or piston initial displacement. Outside of this region, $F_{HardStop} = 0$.

For more information about these settings, see the Rotational Hard Stop block page.

Block Schematics

The actuator block comprises three Foundation Library blocks:

- Ideal Rotational Motion Sensor
- Rotational Hard Stop
- Rotational Mechanical Converter (IL)

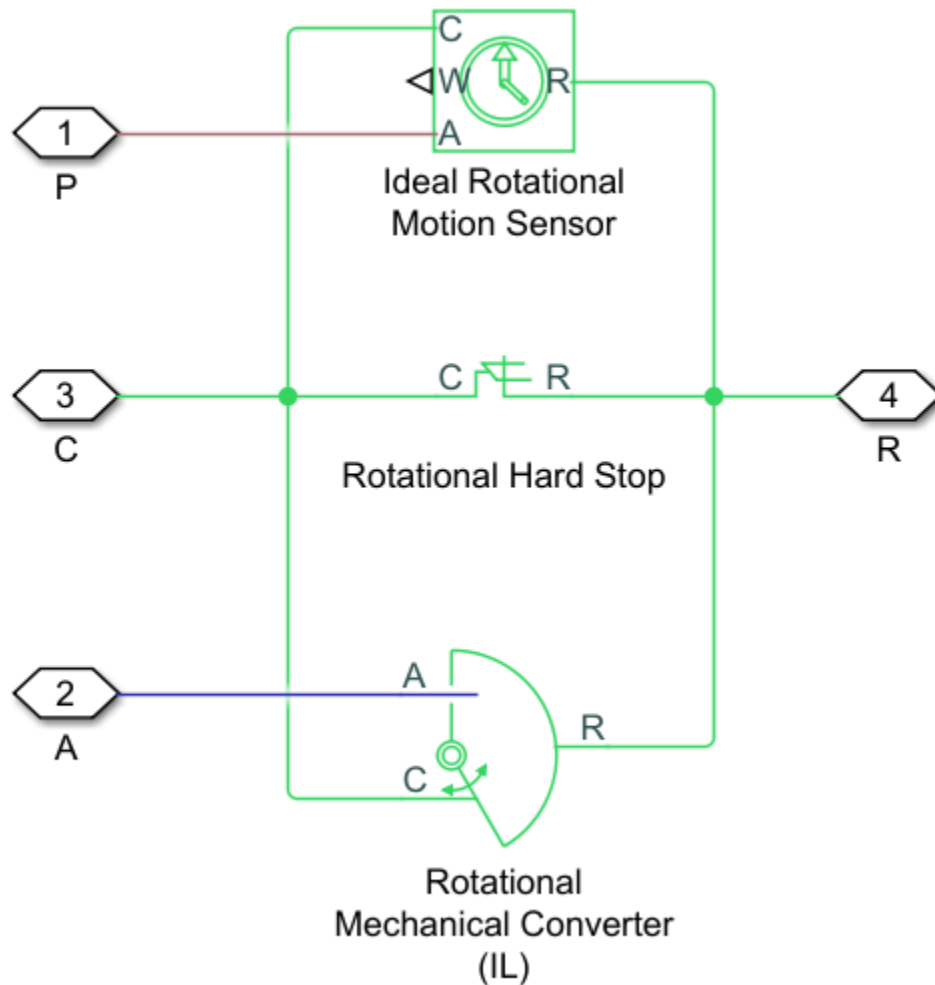

Underlying Block Components

Leakage

Laminar leakage is not accounted for in the Single-Acting Rotary Actuator (IL) block. To include leakage in your simulation, set the **Cross-sectional geometry** parameter to **Custom** and connect port **A** to port **A** of the Laminar Leakage (IL) block. Connect port **B** of the Laminar Leakage (IL) block to a Reservoir (IL) block.

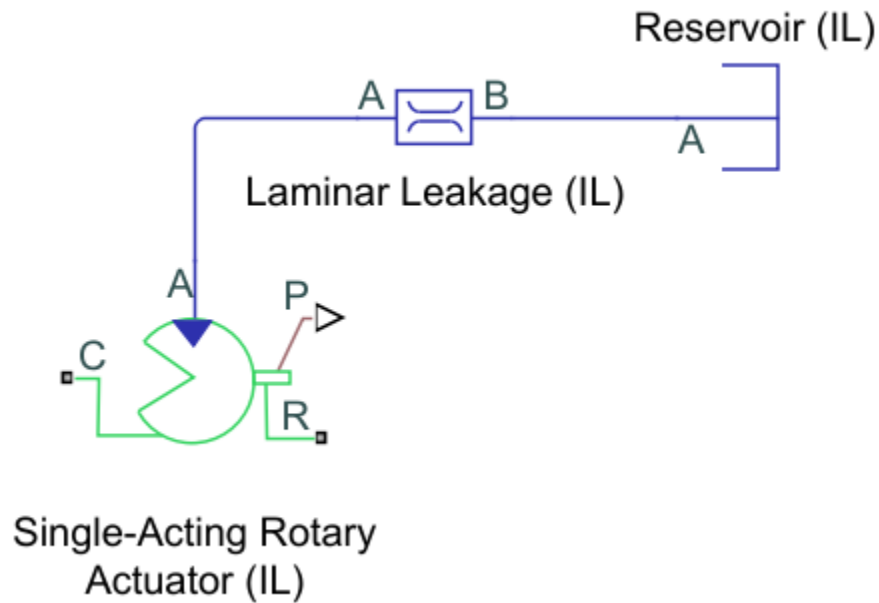

Adding Leakage to the Simulation

Ports

Conserving

A – Liquid port

isothermal liquid

Isothermal liquid conserving port associated with the actuator.

R – Actuator

mechanical translational

Mechanical rotational conserving port associated with the shaft angular velocity and torque.

C – Casing

mechanical translational

Mechanical rotational conserving port associated with the actuator casing.

Input

q – Shaft angle

physical signal

Shaft angle, received as a physical signal from a Simscape Multibody block.

Dependencies

To expose this port, set **Shaft rotation from chamber A** to Provide input signal from Multibody joint.

Output

q – Shaft angle

physical signal

Shaft angle, reported as a physical signal.

Dependencies

To expose this port, set **Shaft rotation from chamber A** to Calculate from angular velocity of port R relative to port C.

Parameters

Actuator

Mechanical orientation – Piston displacement direction

Pressure at A causes positive displacement of R relative to C (default) | Pressure at A causes negative displacement of R relative to C

Sets the piston displacement direction. When you set this parameter to:

- Pressure at A causes positive displacement of R relative to C the piston displacement is positive when the volume of liquid at port A is expanding. This corresponds to rod extension.
- Pressure at A causes negative displacement of R relative to C the piston displacement is negative when the volume of liquid at port A is expanding. This corresponds to rod contraction.

Volume displacement – Volume displacement

$1e-4 \text{ m}^3/\text{rad}$ (default) | positive scalar

Effective displacement of the actuator.

Stroke – Angle

5.0 rad (default) | positive scalar

Shaft maximum travel between stops.

Dead volume – Fluid volume

$1e-5 \text{ m}^3$ (default) | positive scalar

Volume of liquid when the piston displacement is 0. This is the liquid volume when the piston is up against the actuator end cap.

Environment pressure specification – Pressure reference source

Atmospheric pressure (default) | Specified pressure

Choice of environment pressure. Options include Atmospheric pressure and Specified pressure.

Environment pressure – User-defined pressure reference

0.101325 MPa (default)

Pressure outside the actuator casing. This pressure acts against the pressures inside the actuator chambers. A value of zero corresponds to a vacuum.

Dependencies

To enable this parameter, set **Environment pressure specification** to Specified pressure.

Hard Stop

Hard stop stiffness coefficient – Stiffness coefficient

1e6 N*m/rad (default) | positive scalar

Specifies the elastic property of colliding bodies for the Rotational Hard Stop block. The greater the value of the parameter, the more rigid the impact between the piston and the stop becomes. Lower values make contact softer and generally improve convergence and computational efficiency.

Hard stop damping coefficient – Damping coefficient

150 N*m(rad/s) (default) | positive scalar

Specifies the dissipating property of colliding bodies for the Rotational Hard Stop block. At zero damping, the impact is elastic. The greater the value of the parameter, the greater the energy dissipation during piston-stop interaction. Damping affects slider motion as long as the slider is in contact with the stop, including the period when slider is pulled back from the contact. Set this parameter to a nonzero value to improve the efficiency and convergence of your simulation.

Hard stop model – Model choice for force on piston at full extension or retraction

Stiffness and damping applied smoothly through transition region, damped rebound (default) | Full stiffness and damping applied at bounds, undamped rebound | Full stiffness and damping applied at bounds, damped rebound

Model choice for the force on the piston at full extension or full retraction. See the Rotational Hard Stop block for more information.

Transition region – Transition region

0.001 rad (default) | positive scalar

Distance below which scaling is applied to the hard-stop force. The contact force is zero when the distance to the hard stop is equal to the value of this parameter. The contact force is at its full value when the distance to the hard stop is zero.

Initial Conditions

Shaft rotation from chamber A – Method for determining shaft angle

Calculate from angular velocity of port R relative to port C (default) | Provide input signal from Multibody joint

Method for determining the shaft angle. The block can receive the angle from a Multibody block when set to Provide input signal from Multibody joint, or calculates the angle internally, which is reported at port **q**.

Initial shaft rotation – Initial rotation

0 rad (default) | scalar

The position of the actuator at the beginning of simulation. This value falls between 0 and the value of the **Stroke** in the positive orientation, and 0 and the negative value of the **Stroke** in the negative orientation.

Dependencies

To enable this parameter, set **Shaft rotation from chamber A** to Calculate from angular velocity of port R relative to port C.

Fluid dynamic compressibility – Fluid compressibility

On (default) | Off

Whether to model any change in fluid density due to fluid compressibility. When **Fluid compressibility** is set to On, changes due to the mass flow rate into the block are calculated in addition to density changes due to changes in pressure. In the Isothermal Liquid Library, all blocks calculate density as a function of pressure.

Initial liquid pressure – Liquid pressure

0.101325 MPa (default) | positive scalar

Pressure in actuator chamber A at the start of simulation.

Dependencies

To enable this parameter, set **Fluid dynamic compressibility** to On.

See Also

Rotating Single-Acting Actuator (IL) | Single-Acting Actuator (IL) | Double-Acting Rotary Actuator (IL) | Double-Acting Actuator (IL)

Topics

“Connecting Simscape Networks to Simscape Multibody Joints”

Introduced in R2020a

Single-Acting Rotary Actuator

Single-acting hydraulic rotary actuator



Library

Hydraulic Cylinders

Description

The Single-Acting Rotary Actuator block models a single-acting hydraulic rotary actuator, which directly converts hydraulic energy into mechanical rotational energy without employing intermediary transmissions such as rack-and-pinion, sliding spline, chain, and so on. Single-acting actuators generate torque and motion in a single direction only. Use an external device, such as a spring or another opposite installed actuator, to move the shaft in the opposite direction.

The model of the actuator is built of Simscape Foundation library blocks. The schematic diagram of the model is shown below.

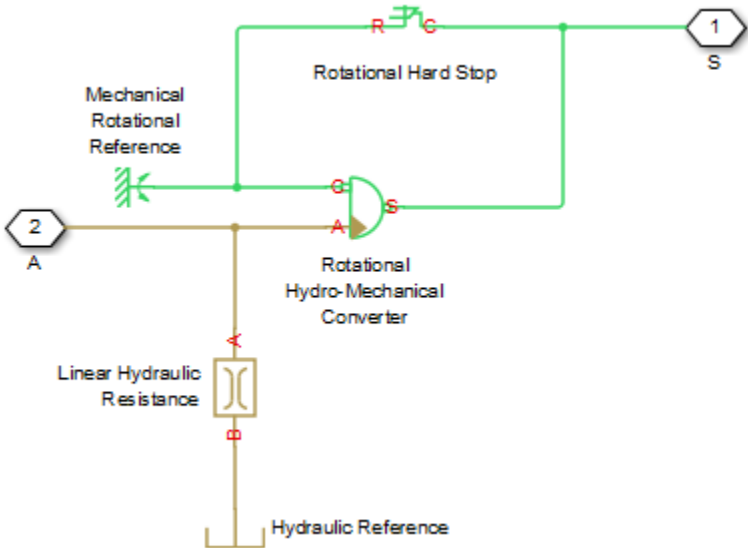

The blocks in the diagram perform the following functions:

Rotational Hydro-Mechanical Converter	Converts hydraulic energy into mechanical rotational energy and vice versa, while accounting for fluid compressibility.
Rotational Hard Stop	Imposes limits on shaft rotation.

Linear Hydraulic Resistance	Accounts for leakages.
-----------------------------	------------------------

Connection A is a hydraulic conserving port corresponding to the actuator chamber. Connection S is a mechanical rotational conserving port associated with the actuator shaft.

The block directionality is adjustable and can be controlled with the **Actuator orientation** parameter.

Basic Assumptions and Limitations

No loading, such as inertia, friction, spring, and so on, is taken into account. If necessary, you can easily add them by connecting an appropriate building block to port S.

Parameters

Actuator displacement

Effective displacement of the actuator. The default value is $4.5e-5 \text{ m}^3/\text{rad}$.

Shaft stroke

Shaft maximum travel between stops. The default value is 5.1 rad .

Shaft initial angle

The position of the shaft at the beginning of simulation. You can set the shaft position to any angle within its stroke. The default value is 0 , which corresponds to the shaft position at the very beginning of the stroke.

Dead volume

Fluid volume that remains in the chamber when the shaft is positioned at the very beginning of the stroke. The default value is $1e-4 \text{ m}^3$.

Leak coefficient

Leak coefficient for the Linear Hydraulic Resistance block. The default value is $1e-14 \text{ (m}^3/\text{s)/Pa}$.

Specific heat ratio

Gas-specific heat ratio for the Hydraulic Piston Chamber block. The default value is 1.4 .

Contact stiffness

Specifies the elastic property of colliding bodies for the Rotational Hard Stop block. The greater the value of the parameter, the less the bodies penetrate into each other, the more rigid the impact becomes. Lesser value of the parameter makes contact softer, but generally improves convergence and computational efficiency. The default value is $1e6 \text{ N}\cdot\text{m}/\text{rad}$.

Contact damping

Specifies dissipating property of colliding bodies for the Rotational Hard Stop block. At zero damping, the impact is close to an absolutely elastic one. The greater the value of the parameter, the more energy dissipates during an interaction. Keep in mind that damping affects slider motion as long as the slider is in contact with the stop, including the period when slider is pulled back from the contact. For computational efficiency and convergence reasons, MathWorks recommends that you assign a nonzero value to this parameter. The default value is $150 \text{ N}\cdot\text{m}/(\text{rad}/\text{s})$.

Hard stop model

Modeling approach for hard stops. Options include:

- **Stiffness and damping applied smoothly through transition region (default)** — Scale the magnitude of the contact force from zero to its full value over a specified transition length. The scaling is polynomial in nature. The polynomial scaling function is numerically smooth and it produces no zero crossings of any kind.
- **Full stiffness and damping applied at bounds, undamped rebound** — Apply the full value of the calculated contact force when the hard-stop location is breached. The contact force is a mix of spring and damping forces during penetration and a spring force—without a damping component—during rebound. No smoothing is applied.
- **Full stiffness and damping applied at bounds, damped rebound** — Apply the full value of the calculated contact force when the hard-stop location is breached. The contact force is a mix of spring and damping forces during both penetration and rebound. No smoothing is applied. This is the hard-stop model used in previous releases.

Transition region

Distance below which scaling is applied to the hard-stop force. The contact force is zero when the distance to the hard stop is equal to the value specified here. It is at its full value when the distance to the hard stop is zero. The default value is 1 mm.

Actuator orientation

Specifies actuator orientation with respect to the globally assigned positive direction. The actuator can be installed in two different ways, depending upon whether it generates torque in the positive or in the negative direction when pressure is applied at its inlet. If pressure applied at port A generates torque in the negative direction, set the parameter to `Acts in negative direction`. The default value is `Acts in positive direction`.

Restricted Parameters

When your model is in Restricted editing mode, you cannot modify the following parameter:

- **Actuator orientation**

All other block parameters are available for modification.

Global Parameters

Parameter determined by the type of working fluid:

- **Fluid bulk modulus**

Use the Hydraulic Fluid block or the Custom Hydraulic Fluid block to specify the fluid properties.

Ports

The block has the following ports:

A

Hydraulic conserving port associated with the actuator inlet.

S

Mechanical rotational conserving port associated with the actuator shaft.

Extended Capabilities

C/C++ Code Generation

Generate C and C++ code using Simulink® Coder™.

See Also

Linear Hydraulic Resistance | Rotational Hard Stop | Rotational Hydro-Mechanical Converter

Topics

“Upgrading Simscape Fluids Models Containing Hydraulics (Isothermal) Blocks”

Introduced in R2007a

Specific Dissipation Heat Transfer

Simple heat transfer model between two general fluids

Library: Simscape / Fluids / Fluid Network Interfaces / Heat Exchangers / Fundamental Components

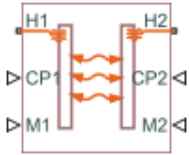

Description

The Specific Dissipation Heat Transfer block models the heat transfer between two fluids given only minimal knowledge of component parameters. The fluids are controlled by physical signals, with these providing the entrance mass flow rate and isobaric specific heat for each. Thermal ports set the entrance temperatures of the fluids.

The rate of heat transfer is calculated from the specific dissipation, a parameter specified in tabulated form as a function of the entrance mass flow rates. The specific dissipation quantifies the amount of heat exchanged between the fluids per unit of time when the entrance temperatures differ by one degree.

Pressure losses and other aspects of flow mechanics are ignored. To capture such effects, use the heat exchanger interface blocks provided in the same library. Combine heat transfer and heat exchanger blocks to model a custom heat exchanger. See the composite block diagrams of the heat exchanger blocks for examples.

Heat Transfer Rate

Heat flows from the warmer fluid to the cooler fluid, at a rate proportional to the difference between the fluid entrance temperatures. The heat flow rate is positive if fluid 1 enters at a higher temperature than fluid 2—and therefore if heat flows from fluid 1 to fluid 2:

$$Q = SD(T_{1,in} - T_{2,in}),$$

where $T_{*,in}$ are the fluid entrance temperatures, determined by the conditions at thermal port **H1** for fluid 1 and **H2** for fluid 2. SD is the specific dissipation obtained from the specified tabulated data at the given mass flow rates:

$$SD = SD(\dot{m}_1, \dot{m}_2),$$

where \dot{m} are the entrance mass flow rates, specified through physical signal port **M1** for fluid 1 and **M2** for fluid 2. The specific dissipation can be calculated for a set of entrance mass flow rates (\dot{m}_1 , \dot{m}_2) given the experimental values of the heat transfer rate and the corresponding entrance temperature difference:

$$SD = \frac{Q}{T_{1,in} - T_{2,in}}.$$

Maximum Heat Transfer Rate

The heat transfer rate is constrained so that the specific dissipation used in the calculations can never exceed the maximum value:

$$SD_{\max} = \min(C_1, C_2),$$

where C_* are the thermal capacity rates of the controlled fluids, each defined as:

$$C_* = \dot{m}_* c_{p,*},$$

with $c_{p,*}$ denoting the isobaric specific heat of the fluid, specified through physical signal port **CP1** for fluid 1 and **CP2** for fluid 2. The constraint on the maximum heat transfer rate is implemented in the form of a piecewise function:

$$Q = \begin{cases} SD_{\max}(T_{1,in} - T_{2,in}), & \text{if } SD > SD_{\max} \\ SD(T_{1,in} - T_{2,in}), & \text{otherwise} \end{cases},$$

A warning is issued whenever the heat flow rate exceeds the maximum value, $SD_{\max}(T_{1,in} - T_{2,in})$, if the **Check if violating maximum specific dissipation** block parameter is set to **Warning**.

Ports

Input

CP1 — Isobaric specific heat of controlled fluid 1

physical signal

Isobaric specific heat of controlled fluid 1.

CP2 — Isobaric specific heat of controlled fluid 2

physical signal

Isobaric specific heat of controlled fluid 2.

M1 — Entrance mass flow rate of controlled fluid 1

physical signal

Entrance mass flow rate of controlled fluid 1. Positive values indicate flow into the heat exchanger. Negative values indicate flow out of the heat exchanger.

M2 — Entrance mass flow rate of controlled fluid 2

physical signal

Entrance mass flow rate of controlled fluid 2. Positive values indicate flow into the heat exchanger. Negative values indicate flow out of the heat exchanger.

Conserving

H1 — Entrance temperature of controlled fluid 1

thermal

Entrance temperature of controlled fluid 1.

H2 — Entrance temperature of controlled fluid 2

thermal

Entrance temperature of controlled fluid 2.

Parameters**Thermal Liquid mass flow rate vector, mdot1 — Entrance mass flow rate at which to specify specific-dissipation data**

[.3, .5, .6, .7, 1, 1.4, 1.9, 2.3] kg/s (default) | M -element array with units of mass/time

Array of mass flow rates at the inlet for controlled fluid 1. Each value corresponds to a row in the specific dissipation lookup table. Positive values indicate flow into the heat exchanger and negative values indicate flow out of the heat exchanger.

Controlled fluid mass flow rate vector, mdot2 — Entrance mass flow rate at which to specify specific-dissipation data

[.3, .5, 1, 1.3, 1.7, 2, 2.6, 3.3] kg/s (default) | N -element array with units of mass/time

Array of mass flow rates at the inlet for controlled fluid 2. Each value corresponds to a row in the specific dissipation lookup table. Positive values indicate flow into the heat exchanger and negative values indicate flow out of the heat exchanger.

Specific dissipation table, $\text{SD}(\text{mdot1}, \text{mdot2})$ — Specific dissipation values corresponding to specified mass flow rates

8-by-8 matrix with units of kW/K (default) | M -by- N matrix with units of power/temperature

Matrix of specific dissipation values corresponding to the specified mass flow rate arrays for controlled fluids 1 and 2. The block uses the tabulated data to calculate the heat transfer at the simulated operating conditions.

Mass flow rate threshold for flow reversal — Mass flow rate below which to smooth numerical data

1e-3 kg/s (default) | scalar with units of mass/time

Mass flow rate below which to initiate a smooth flow reversal to prevent discontinuities in the simulation data.

Check if violating maximum specific dissipation — Option to warn if the specific dissipation exceeds the maximum allowed value

Warning (default) | None

Option to warn if the specific dissipation exceeds the maximum value described in the block description.

Extended Capabilities**C/C++ Code Generation**

Generate C and C++ code using Simulink® Coder™.

See Also

Simple Heat Exchanger Interface (G) | Simple Heat Exchanger Interface (TL)

Introduced in R2017b

Spool Orifice (IL)

Variable-area spool orifice in an isothermal system

Library: Simscape / Fluids / Isothermal Liquid / Valves & Orifices / Orifices

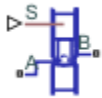

Description

The Spool Orifice (IL) block models a variable-area orifice between a spool and a sleeve with holes. The sleeve holes can be either a series of round or rectangular holes. The flow rate is based on the total opening area between the sleeve, holes, and spool, which extends or retracts according to the signal received at port **S**. Multiple Spool Orifice (IL) blocks can be connected for multiple sets of holes along a spool-sleeve pair.

If the spool displacement in your system is supplied by an external source or custom block and you would like the axial flow force to be transmitted to the system, you can use the Spool Orifice Flow Force (IL) block, which applies the same equations for force as the Spool Orifice (IL) block.

Flow Force

The force on the spool is calculated as:

$$F = \frac{-\dot{m}_A^2}{\rho A} \cos(\alpha) \varepsilon,$$

where:

- \dot{m}_A is the mass flow rate at port **A**.
- ρ is the fluid density.
- A is the orifice open area, which is determined by the spool position and orifice parameterization.
- α is the jet angle, which is calculated from an approximation of the Von Mises formula:

$$\alpha_{jet} = 0.3663 + 0.8373 \left(1 - e^{\frac{-h}{1.848c}} \right),$$

where c is the **Radial clearance**, and h is the orifice opening.

- ε is the **Orifice orientation**, which indicates orifice opening that is associated with a positive or negative signal at **S**.

Orifice Opening Area

For variable orifices, setting **Orifice orientation** to **Positive** spool displacement opens the orifice indicates that the orifice opens when the control member extends, while **Negative** spool displacement opens the orifice indicates that the orifice opens when the control member retracts.

The **Leakage area**, A_{leak} , is considered a small area open to flow when the orifice is closed, which maintains numerical continuity. Additionally, a nonzero **Smoothing factor** can provide increased numerical stability when the orifice is in near-closed or near-open position.

Round Holes

Setting **Orifice parameterization** to Round holes evenly distributes a user-defined number of holes along the sleeve perimeter with the equal diameters and centers aligned in the same plane.

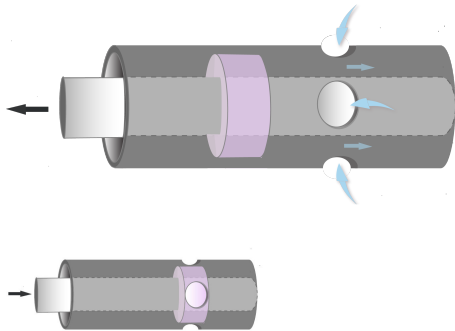

The open area is calculated as:

$$A_{orifice} = n_0 \frac{d_0^2}{8} (\theta - \sin(\theta)) + A_{leak}.$$

The orifice opening angle, θ , is set by the control signal at **S**:

$$\theta = 2 \cos^{-1} \left(\theta - \frac{2\Delta S}{d_0} \right),$$

where:

- n_0 is the number of holes.
- d_0 is the diameter of the holes.
- A_{leak} is $A_{leak} = cd_0n_0$.
- ΔS is the control member travel distance, $\varepsilon(S - S_{min})$, where S_{min} is the **Control member position at closed orifice**.

The maximum open area is:

$$A_{max} = \frac{\pi}{4} d_0^2 n_0 + A_{leak}.$$

Rectangular Slot

Setting **Orifice parameterization** to Rectangular slot models one rectangular slot in the tube sleeve.



For an orifice with a slot in a rectangular sleeve, the open area is

$$A_{orifice} = w\Delta S + A_{leak},$$

where w is the orifice width.

The maximum opening distance between the sleeve and case is:

$$A_{max} = w\Delta S_{max} + A_{leak}.$$

where ΔS_{max} is the slot orifice **Spool travel between closed and open orifice** distance.

At the minimum orifice opening area, the leakage area is:

$$A_{leak} = cw.$$

Numerically-Smoothed Displacement

At the extremes of the orifice opening range, you can maintain numerical robustness in your simulation by adjusting the block **Smoothing factor**. A smoothing function is applied to every calculated displacement, but primarily influences the simulation at the extremes of this range.

The normalized orifice opening is:

$$\Delta\hat{S} = \frac{\Delta S}{\Delta S_{max}},$$

where ΔS_{max} is the:

- **Diameter of round holes**, when **Orifice parameterization** is set to Round holes.
- **Spool travel between closed and open orifice**, when **Orifice parameterization** is set to Rectangular slot.

When the **Smoothing factor**, f , is nonzero, a smoothing function is applied to the normalized opening:

$$\Delta\hat{S}_{smoothed} = \frac{1}{2} + \frac{1}{2}\sqrt{(\Delta\hat{S})^2 + \left(\frac{f}{4}\right)^2} - \frac{1}{2}\sqrt{(\Delta\hat{S} - 1)^2 + \left(\frac{f}{4}\right)^2}.$$

The smoothed opening is:

$$\Delta S_{smoothed} = \Delta\hat{S}_{smoothed}\Delta S_{max}.$$

The Mass Flow Rate Equation

The flow through a spool orifice is calculated by the pressure-flow rate equation:

$$\dot{m} = \frac{C_d A_{orifice} \sqrt{2\bar{\rho}}}{\sqrt{PR_{loss} \left(1 - \left(\frac{A_{orifice}}{A}\right)^2\right)}} \frac{\Delta p}{[\Delta p^2 + \Delta p_{crit}^2]^{1/4}},$$

where:

- C_d is the **Discharge coefficient**.
- A is the **Cross-sectional area at ports A and B**.

- $\bar{\rho}$ is the average fluid density.
- $A_{orifice}$ is the orifice open area, unless:
 - The opening is larger than or equal to the area at the **Spool travel between closed and open orifice** distance. The orifice area is then A_{max} .
 - The orifice opening is less than or equal to the minimum opening distance. The orifice area is then A_{leak} .

The critical pressure difference, Δp_{crit} , is the pressure differential associated with the **Critical Reynolds number**, Re_{crit} , which is the point of transition between laminar and turbulent flow in the fluid:

$$\Delta p_{crit} = \frac{\pi \bar{\rho}}{8 A_{orifice}} \left(\frac{\nu Re_{crit}}{C_d} \right)^2.$$

Pressure loss describes the reduction of pressure in the orifice due to a decrease in area. PR_{loss} is calculated as:

$$PR_{loss} = \frac{\sqrt{1 - \left(\frac{A_{orifice}}{A_{port}} \right)^2 (1 - C_d^2)} - C_d \frac{A_{orifice}}{A_{port}}}{\sqrt{1 - \left(\frac{A_{orifice}}{A_{port}} \right)^2 (1 - C_d^2)} + C_d \frac{A_{orifice}}{A_{port}}}.$$

Pressure recovery describes the positive pressure change in the orifice due to an increase in area. If you do not wish to capture this increase in pressure, set **Pressure recovery** to Off. In this case, PR_{loss} is 1.

Ports

Conserving

A — Liquid port

isothermal liquid

Entry or exit port of the liquid to or from the orifice.

B — Liquid port

isothermal liquid

Entry or exit port of the liquid to or from the orifice.

Input

S — Control member displacement, m

physical signal

Control member displacement for a variable-area orifice, in m.

Output

F — Flow force, N

physical signal

Axial flow force, in N.

Parameters

Orifice parameterization — Type of orifice

Round holes (default) | Rectangular slot

Hole geometry in the sleeve. The round holes are spaced evenly about the cross-sectional circumference. There is only one hole in the Rectangular slot setting.

Diameter of round holes — Diameter of round holes

5e-3 m (default) | positive scalar

Diameter of all holes on the sleeve.

Dependencies

To enable this parameter, set **Orifice parameterization** to Round holes.

Number of round holes — Number of round holes

6 (default) | positive integer

Number of holes along the sleeve circumference.

Dependencies

To enable this parameter, set **Orifice parameterization** to Round holes.

Orifice width — Rectangular slot width

0.01 m (default) | positive scalar

Rectangular slot width.

Dependencies

To enable this parameter, set **Orifice parameterization** to Rectangular slot.

Spool travel between closed and open orifice — Control member maximum stroke

5e-3 m (default) | positive scalar

Maximum distance of the control member travel. This value provides an upper limit to calculations so that simulations do not return unphysical values.

Dependencies

To enable this parameter, set **Orifice parameterization** to Rectangular slot.

Flow force output — Whether to model axial hydraulic force on the spool

Off (default) | On

Whether to model the axial hydraulic force on the spool. When this parameter is set to On, port **F** is enabled and outputs the axial force as a physical signal, in N.

Radial clearance — Spool-sleeve clearance

1e-5 m (default) | positive scalar

Radial distance between the spool and the sleeve.

Dependencies

To enable this parameter, set **Flow force effect** to On.

Leakage area — Gap area when valve is in fully closed position

1e-10 m² (default) | positive scalar

Sum of all gaps when the valve is in the fully closed position. Any area smaller than this value is saturated to the specified leakage area. This contributes to numerical stability by maintaining continuity in the flow.

Spool position at closed orifice — Spool offset

0 (default) | scalar

Spool offset when the orifice is fully open. A positive, nonzero value indicates a partially closed orifice. A negative, nonzero value indicates an overlapped orifice that remains open for an initial displacement set by the physical signal at port **S**.

Cross-sectional area at ports A and B — Orifice area at conserving ports

inf m² (default) | positive scalar

Cross-sectional area at the entry and exit ports **A** and **B**. This area is used in the pressure-flow rate equation that determines the mass flow rate through the orifice.

Opening orientation — Direction of changing orifice area

Positive spool displacement opens the orifice (default) | Negative spool displacement opens the orifice

Direction of the area change for variable orifices. A positive opening orientation indicates an increase in the orifice opening. A negative orientation indicates a decrease in the orifice opening. The magnitude is always positive.

Discharge coefficient — Discharge coefficient

0.64 (default) | positive scalar in the range of [0,1]

Correction factor that accounts for discharge losses in theoretical flows.

Critical Reynolds number — Upper Reynolds number limit for laminar flow

150 (default) | positive scalar

Upper Reynolds number limit for laminar flow through the orifice.

Smoothing factor — Numerical smoothing factor

0.01 (default) | positive scalar

Continuous smoothing factor that introduces a layer of gradual change to the flow response when the orifice is in near-open or near-closed positions. Set this value to a nonzero value less than one to increase the stability of your simulation in these regimes.

Pressure recovery — Whether to account for pressure increase in area expansions

Off (default) | On

Whether to account for pressure increase when fluid flows from a region of smaller cross-sectional area to a region of larger cross-sectional area.

See Also

Spool Orifice Flow Force (IL) | Variable Overlapping Orifice (IL) | Annular Leakage (IL) | Orifice (IL)

Introduced in R2020a

Spool Orifice Flow Force (IL)

Axial fluid force on spool orifice in an isothermal liquid system

Library: Simscape / Fluids / Valve Actuators & Forces

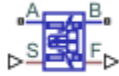

Description

The Spool Orifice Flow Force (IL) block models the hydraulic axial force on a spool orifice. It receives the spool position as a physical signal at port **S**. You can also model the flow through a spool orifice with round or rectangular holes. A positive force acts to close the orifice.

If you would like to model the spool and axial force in one block, use the Spool Orifice (IL) block. The axial force is output as a physical signal at port **F**.

Flow Force

The force on the spool is calculated as:

$$F = \frac{-\dot{m}_A^2}{\rho A} \cos(\alpha) \varepsilon,$$

where:

- \dot{m}_A is the mass flow rate at port **A**.
- ρ is the fluid density.
- A is the orifice open area, which is determined by the spool position and orifice parameterization.
- α is the jet angle, which is calculated from an approximation of the Von Mises formula:

$$\alpha_{jet} = 0.3663 + 0.8373 \left(1 - e^{\frac{-h}{1.848c}} \right),$$

where c is the **Radial clearance** and h is the orifice opening.

- ε is the opening orientation, which indicates orifice opening that is associated with a positive or negative signal at **S**.

Opening Area

The orifice opening is based on the open area created by the displaced spool:

$$\Delta S = (S - S_{\min}) \varepsilon,$$

where:

- S_{\min} is the **Spool position at closed orifice**.
- S is the displacement signal at port **S**.

If Δs falls below 0, the orifice leakage area is used. If ΔS is greater than the **Spool travel between closed and open orifice**, the maximum orifice area is used.

Round Holes

Setting **Orifice geometry** to Round holes evenly distributes a user-defined number of holes along the sleeve perimeter that have equal diameters and centers aligned in the same plane.

The open area is calculated as:

$$A_{orifice} = n_0 \frac{d_0^2}{8} \left(\theta - \sin\left(\frac{\theta}{2}\right) \right) + A_{leak},$$

where:

- n_0 is the number of holes.
- d_0 is the diameter of the holes.
- θ is the orifice opening angle:

$$\theta = \cos^{-1}\left(1 - 2\frac{\Delta S}{d_0}\right).$$

If θ is greater than 2π , θ remains at 2π .

- A_{leak} is the **Leakage area**.

The maximum open area is:

$$A_{max} = \frac{\pi}{4} d_0^2 n_0 + A_{leak}.$$

Rectangular Slot

Setting **Orifice geometry** to Rectangular slot models one rectangular slot in the tube sleeve.

For an orifice with a slot in a rectangular sleeve, the open area is

$$A_{orifice} = w\Delta S + A_{leak},$$

where w is the orifice width.

The maximum opening distance between the sleeve and case is:

$$A_{max} = w\Delta S_{max} + A_{leak}.$$

where ΔS_{max} is the **Spool travel between closed and open orifice**.

Numerically-Smoothed Displacement

At the extremes of the orifice opening range, you can maintain numerical robustness in your simulation by adjusting the block **Smoothing factor**. A smoothing function is applied to every calculated displacement, but primarily influences the simulation at the extremes of this range.

The normalized orifice opening is:

$$\Delta \hat{S} = \frac{\Delta S}{\Delta S_{max}},$$

where ΔS_{max} is the:

- **Diameter of round holes**, when **Orifice parameterization** is set to Round holes.
- **Spool travel between closed and open orifice**, when **Orifice parameterization** is set to Rectangular slot.

When the **Smoothing factor**, f , is nonzero, a smoothing function is applied to the normalized opening:

$$\Delta \widehat{S}_{smoothed} = \frac{1}{2} + \frac{1}{2} \sqrt{(\Delta \widehat{S})^2 + \left(\frac{f}{4}\right)^2} - \frac{1}{2} \sqrt{(\Delta \widehat{S} - 1)^2 + \left(\frac{f}{4}\right)^2}.$$

The smoothed opening is:

$$\Delta S_{smoothed} = \Delta \widehat{S}_{smoothed} \Delta S_{max}.$$

Ports

Conserving

A — Liquid port

isothermal liquid

Liquid entry or exit port to the block.

B — Liquid port

isothermal liquid

Liquid entry or exit port to the block.

Input

S — Control member displacement, m

physical signal

Spool displacement in m, specified as a physical signal.

Output

F — Flow force, N

physical signal

Axial flow force in N, specified as a physical signal.

Parameters

Orifice geometry — Type of orifice

Round holes (default) | Rectangular slot

Whether the modeled spool has round holes or a rectangular slot in the sleeve.

Diameter of round holes — Diameter of round holes

5e-3 m (default) | positive scalar

Diameter of all holes on the sleeve.

Dependencies

To enable this parameter, set **Orifice geometry** to Round holes.

Number of round holes — Number of round holes

6 (default) | positive integer

Number of holes along the sleeve circumference.

Dependencies

To enable this parameter, set **Orifice geometry** to Round holes.

Orifice width — Rectangular slot width

0.01 m (default) | positive scalar

Rectangular slot width.

Dependencies

To enable this parameter, set **Orifice geometry** to Rectangular slot.

Spool travel between closed and open orifice — Maximum spool stroke

1 m (default) | positive scalar

Maximum orifice opening, including the **Spool position at maximum orifice area**.

Dependencies

To enable this parameter, set **Orifice geometry** to Rectangular slot.

Radial clearance — Spool-sleeve clearance

1e-5 m (default) | positive scalar

Radial distance between the spool and the sleeve.

Spool position at closed orifice — Initial spool offset

0 m (default) | scalar

Initial offset if the spool is extended or retracted in its neutral position.

Opening orientation — Direction of changing orifice area

Positive spool displacement opens orifice (default) | Negative spool displacement closes orifice

Direction of member movement that opens the orifice. A positive orientation indicates that positive control member displacement increases the orifice opening. A negative orientation indicates that negative control member displacement increases the orifice opening. The magnitude is always positive.

Smoothing factor — Numerical smoothing factor

0.01 (default) | positive scalar in the range [0,1]

Continuous smoothing factor that introduces a layer of gradual change to the flow response when the valve is in near-open or near-closed positions. Set this value to a nonzero value less than one to increase the stability of your simulation in these regimes.

References

[1] Manring, N. *Hydraulic Control Systems*. John Wiley & Sons, 2005.

[2] Merritt, H. *Hydraulic Control Systems*. Wiley, 1967.

See Also

Spool Orifice (IL) | Variable Overlapping Orifice (IL)

Introduced in R2020a

Spool Orifice Hydraulic Force

Axial hydraulic force exerted on spool

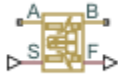

Library

Valve Forces

Description

The Spool Orifice Hydraulic Force block simulates the steady-state axial hydraulic force exerted on the spool by fluid flowing through the orifice. The spool is assumed to be sharp-edged. You have two parameterization options:

- A rectangular slot, to be used with the Orifice with Variable Area Slot block
- A round hole, or a set of round holes, to be used with the Orifice with Variable Area Round Holes block

The width of the slot, or the diameter of the holes, must be considerably larger than the radial clearance between the spool and the sleeve. Connect the Spool Orifice Hydraulic Force block in series with the respective orifice block to monitor the flow rate.

The force is simulated according to the following equations:

$$F = \rho \frac{q^2}{A} \cos\theta \cdot or$$

$$\theta = 0.3663 + 0.8373(1 - \exp(-x/1.848))$$

$$x = x_0 + s \cdot or$$

For rectangular slot,

$$A = \begin{cases} b \cdot \sqrt{x^2 + \delta^2} & \text{for } x > 0 \\ b \cdot \delta & \text{for } x \leq 0 \end{cases}$$

For round holes,

$$A = \begin{cases} A_{\min} + Z \frac{d^2}{8} (\alpha - \sin\alpha) & \text{for } d \geq x \geq 0 \\ A_{\min} & \text{for } x < 0 \\ A_{\min} + A_{\max} & \text{for } x > d \end{cases}$$

$$\alpha = 2 \cdot \arccos\left(1 - 2\frac{x}{d}\right)$$

$$A_{\min} = Z \cdot d \cdot \delta$$

$$A_{\max} = \pi d^2 / 4$$

where

F	Axial hydraulic force
q	Flow rate through the orifice
ρ	Fluid density
A	Orifice area
Θ	Jet angle (rad)
x_0	Orifice initial opening
s	Spool displacement
b	Orifice width, for rectangular slot
D	Orifice diameter, for round holes
Z	Number of round holes
δ	Radial clearance
or	Orientation parameter with respect to the globally assigned positive direction. If the orifice is opened while the spool is shifted in positive direction, or equals 1. If the orifice is opened while the spool is shifted in negative direction, or equals -1.

Connections A and B are hydraulic conserving ports that should be connected in series with the orifice block to monitor the flow rate. Connection S is a physical signal port that provides the spool displacement. Connection F is a physical signal port that outputs the hydraulic axial force value. This port should be connected to the control port of an Ideal Force Source block. The force computed in the block always acts to close the orifice.

Basic Assumptions and Limitations

- The transient effects are assumed to be negligible.
- The jet angle approximation is based on the Richard von Mises equation.
- The jet angle variation with the orifice opening is identical for the rectangular slot and the round holes orifices.
- The block can be used with orifices whose width or diameter is considerably larger than the axial opening.

Parameters

Orifice type

Select the type of orifice:

- **Rectangular slot** — Orifice created by the sharp-edged spool and a rectangular slot in the sleeve. This is the default.
- **Round holes** — Orifice created by the sharp-edged spool and a set of round holes evenly distributed along the sleeve perimeter.

Orifice width

Orifice width. The parameter must be greater than zero. The default value is 0.01 m. The parameter is used if **Orifice type** is set to Rectangular slot.

Diameter of round holes

Orifice diameter. If multiple orifices are used, all of them must be of the same diameter, identically aligned with respect to the spool edge, and spaced evenly among the sleeve perimeter. The parameter must be greater than zero. The default value is 0.005 m. The parameter is used if **Orifice type** is set to Round holes.

Number of round holes

Number of round holes in the sleeve. The parameter must be greater than zero. The default value is 4. The parameter is used if **Orifice type** is set to Round holes.

Radial clearance

The radial clearance between the spool and the sleeve. The default value is 1e-5 m.

Initial opening

Orifice initial opening. The parameter can be positive (underlapped orifice), negative (overlapped orifice), or equal to zero for zero lap configuration. The default value is 0.

Orifice orientation

The parameter is introduced to specify the effect of the force on the orifice opening. The parameter can be set to one of two options: **Opens in positive direction** or **Opens in negative direction**. The value **Opens in positive direction** specifies an orifice that opens when the spool moves in the globally assigned positive direction. The default value is **Opens in positive direction**.

Restricted Parameters

When your model is in Restricted editing mode, you cannot modify the following parameters:

- **Orifice type**
- **Orifice orientation**

All other block parameters are available for modification. The actual set of modifiable block parameters depends on the value of the **Orifice type** parameter at the time the model entered Restricted mode.

Ports

The block has the following ports:

A

Hydraulic conserving port associated with an orifice inlet.

B

Hydraulic conserving port associated with an orifice outlet.

S

Physical signal port that provides the spool displacement.

F

Physical signal port that outputs hydraulic axial force.

Examples

The following example shows a model of a 4-way, 3-position, hydraulically-operated directional valve where the hydraulic axial forces acting on the spool are being taken into consideration.

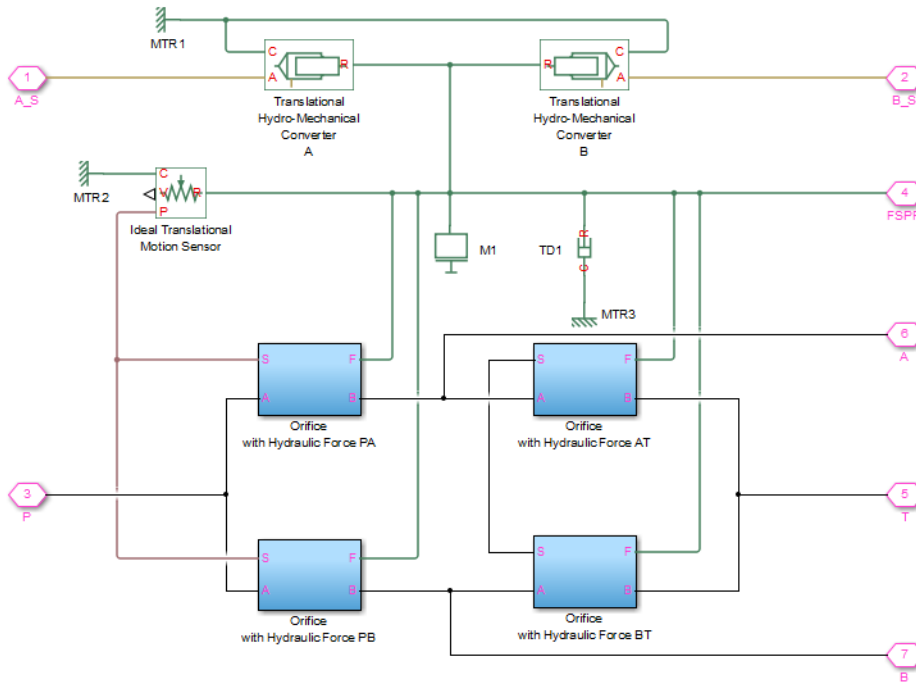

The spool (mass M1, viscous friction TD1) is shifted by the servo-actuator simulated by two Translational Hydro-Mechanical Converter blocks. Connections A_S and B_S are hydraulic ports for applying pilot control pressure.

Four variable orifices are represented by subsystems:

- Orifice with Hydraulic Force PA
- Orifice with Hydraulic Force PB
- Orifice with Hydraulic Force AT
- Orifice with Hydraulic Force BT

The structure of a subsystem is shown in the following illustration.

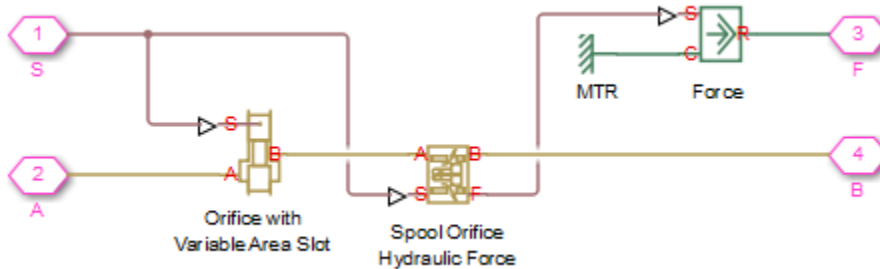

It consists of an Orifice with Variable Area Slot block, which simulates hydraulic properties of the orifice, connected in series with a Spool Orifice Hydraulic Force block. The force value computed in the block is exported through its port F and passed to the Force block.

The forces on all four orifices (F_PA, F_PB, F_AT, F_BT) are applied to the valve spool as it is shown in the first schematic.

For more details and for parameter settings, see the “Servo-Valve Controlling Hydraulic Actuator” example.

Extended Capabilities

C/C++ Code Generation

Generate C and C++ code using Simulink® Coder™.

See Also

Valve Hydraulic Force

Topics

“Upgrading Simscape Fluids Models Containing Hydraulics (Isothermal) Blocks”

Introduced in R2007a

Spring-Loaded Accumulator (IL)

Accumulator with a spring used for energy storage in an isothermal liquid system

Library: Simscape / Fluids / Isothermal Liquid / Tanks & Accumulators



Description

This block models a spring-charged accumulator in an isothermal liquid network. The accumulator consists of a preloaded spring and a liquid chamber.

As the liquid pressure at the accumulator inlet becomes greater than the preload pressure, liquid enters the accumulator and compresses the spring. A decrease in the liquid pressure causes the spring to decompress and discharge stored liquid into the system. The separator motion is restricted by a hard stop when the liquid volume is zero and when the liquid volume is at the liquid chamber capacity.

The inlet liquid resistance and spring properties, such as the spring inertia and damping, are not modeled. The spring pressure is assumed to be linear with respect to the liquid volume. The flow rate is positive if liquid flows into the accumulator.

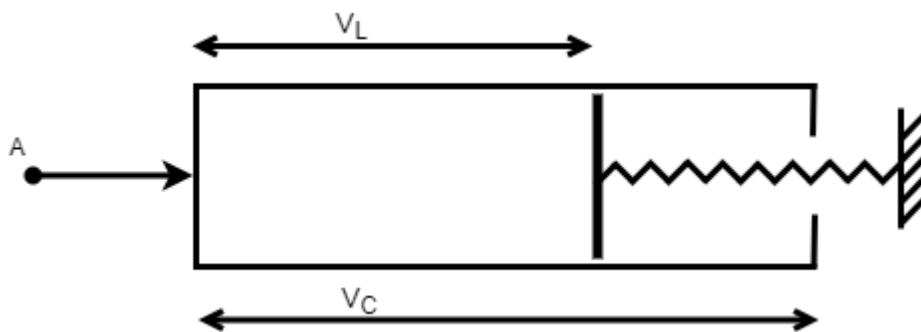

This diagram represents a spring-loaded accumulator.

V_L	Volume of the liquid in the accumulator.
V_C	Liquid chamber capacity
p_{\max}	Pressure at full capacity
p_I	Liquid pressure in the liquid chamber, which is equal to the pressure at the accumulator inlet.
p_{HS}	Hard-stop contact pressure.
K_{stiff}	Hard-stop stiffness coefficient.
K_{spring}	Spring gain.
\dot{m}_A	Mass flow rate of liquid coming into port A.

ρ_I	Density of the liquid in the liquid chamber.
----------	--

Conservation of Mass

Conservation of mass is represented by the following equation.

$$\begin{cases} \dot{p}_I \frac{d\rho_I}{d p_I} V_L + \rho_I \dot{V}_L = \dot{m}_A, & \text{compressibility on} \\ \rho_I \dot{V}_L = \dot{m}_A, & \text{compressibility off} \end{cases}$$

where

$$\dot{V}_L = \begin{cases} \frac{\dot{p}_I}{K_{spring}}, & \text{if } 0 < V_L < V_C \\ \frac{\dot{p}_I}{K_{spring} + K_{stiff}}, & \text{else} \end{cases}$$

Conservation of Momentum

Conservation of momentum is represented by the following equation.

$$p_I = p_{spring} + p_{HS}$$

where

$$p_{spring} = p_{pr} + K_{spring} V_L$$

$$p_{HS} = \begin{cases} (V_L - V_C) K_{stiff}, & \text{if } V_L \geq V_C \\ V_L K_{stiff}, & \text{if } V_L \leq 0 \\ 0, & \text{else} \end{cases}$$

Variables

Use the **Variables** tab to set the priority and initial target values for the block variables prior to simulation. For more information, see “Set Priority and Initial Target for Block Variables”.

Ports

Conserving

A — Hydraulic conserving port

hydraulic conserving

Hydraulic conserving port associated with the accumulator inlet. The flow rate is positive if liquid flows into the accumulator.

Parameters

Liquid capacity — Liquid capacity

8e-3 m³ (default) | positive scalar

Amount of liquid that the accumulator can hold.

Preload pressure – Spring pressure

1.01325 MPa (default) | positive scalar

Spring pressure when the liquid chamber is empty.

Pressure at full capacity – Spring pressure

3.01325 MPa (default) | positive scalar

Spring pressure when the liquid chamber is at capacity.

Hard stop stiffness coefficient – Proportionality constant

1e4 MPa/m³ (default) | positive scalar

Proportionality constant of the hard-stop contact pressure with respect to the liquid volume penetrated into the hard stop. The hard stops are used to restrict the liquid volume between zero and liquid chamber capacity.

Fluid dynamic compressibility – Fluid compressibility

On (default) | Off

Whether to model any change in fluid density due to fluid compressibility. When **Fluid compressibility** is set to On, changes due to the mass flow rate into the block are calculated in addition to density changes due to changes in pressure. In the Isothermal Liquid Library, all blocks calculate density as a function of pressure.

See Also

Gas-Charged Accumulator (IL)

Introduced in R2020a

Spring-Loaded Accumulator

Hydraulic accumulator with spring used for energy storage



Library

Accumulators

Description

This block models a spring-loaded hydraulic fluid accumulator. The accumulator consists of a preloaded spring and a fluid chamber. The fluid chamber is connected to a hydraulic system.

As the fluid pressure at the accumulator inlet becomes greater than the preload pressure, fluid enters the accumulator and compresses the spring, storing hydraulic energy. A decrease in the fluid pressure causes the spring to decompress and discharge stored fluid into the system.

During typical operations, the spring pressure is equal to the pressure in the fluid chamber. However, if the pressure at the accumulator inlet drops below the preload pressure, the spring becomes isolated from the system. In this situation, the fluid chamber is empty and the spring pressure remains constant and equal to the preload pressure while the pressure at the accumulator inlet depends on the hydraulic system to which the accumulator is connected. If the pressure at the accumulator inlet builds up to the preload pressure or higher, fluid enters the accumulator again.

The motion of the spring is restricted by two hard stops that limit the expansion and contraction of the fluid volume. The fluid volume is limited when the fluid chamber is at capacity and when the fluid chamber is empty. The hard stops are modeled with finite stiffness and damping. This means that it is possible for the fluid volume to become negative or greater than the fluid chamber capacity, depending on the values of the hard-stop stiffness coefficient and the accumulator inlet pressure.

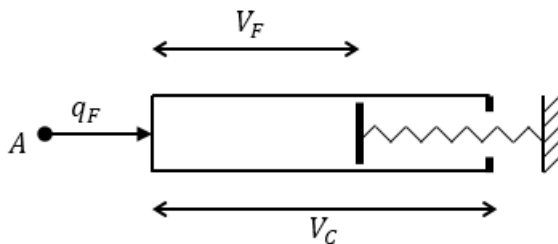

The diagram represents a spring-loaded accumulator. The fluid chamber is on the left and the spring is on the right. The distance between the left side and the spring defines the fluid volume (V_F).

The hard stop contact pressure is modeled with a stiffness term and a damping term. The accumulator spring is assumed to have a linear relationship between the spring pressure and the fluid volume, with pressure balanced at the end of the spring:

$$p_{spr} - p_{pr} = K_{spr}V_F$$

$$p_F = p_{spr} + p_{HS}$$

$$K_{spr} = \frac{p_{max} - p_{pr}}{V_C}$$

$$p_{HS} = \begin{cases} K_S(V_F - V_C) + K_dq_F^\dagger(V_F - V_C) & \text{if } V_F \geq V_C \\ K_S V_F - K_d q_{\bar{F}} V_F & \text{if } V_F \leq 0 \\ 0 & \text{otherwise} \end{cases}$$

$$q_F^\dagger = \begin{cases} q_F & \text{if } q_F \geq 0 \\ 0 & \text{otherwise} \end{cases}$$

$$q_{\bar{F}} = \begin{cases} q_F & \text{if } q_F \leq 0 \\ 0 & \text{otherwise} \end{cases}$$

where

V_F	Volume of fluid in the accumulator
V_{init}	Initial volume of fluid in the accumulator
V_C	Fluid chamber capacity
p_F	Pressure at the accumulator inlet (gauge)
p_{pr}	Preload pressure (gauge)
K_{spr}	Spring gain coefficient
p_{max}	Pressure needed to fully fill the accumulator
p_{spr}	Pressure developed by the spring
p_{HS}	Hard-stop contact pressure
K_s	Hard-stop stiffness coefficient
K_d	Hard-stop damping coefficient
q_F	Fluid flow rate into the accumulator, which is positive if fluid flows into the accumulator

The flow rate into the accumulator is the rate of change of the fluid volume:

$$q_F = \frac{dV_F}{dt}$$

At $t = 0$, the initial condition is $V_F = V_{init}$, where V_{init} is the value you assign to the **Initial fluid volume** parameter.

The Spring-Loaded Accumulator block does not consider loading on the separator. To model additional effects, such as the separator inertia and friction, you can construct a spring-loaded accumulator as a subsystem or a composite component, similar to the block diagram below.

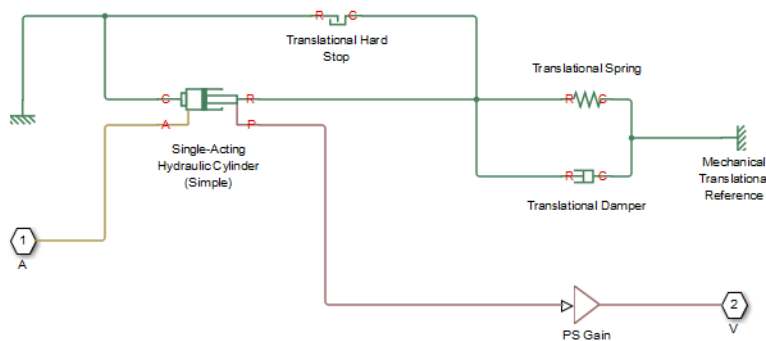

Basic Assumptions and Limitations

- The accumulator spring is assumed to behave linearly.
- Loading on the separator, such as inertia or friction, is not considered.
- Inlet hydraulic resistance is not considered.
- Fluid compressibility is not considered.

Parameters

- “Parameters Tab” on page 1-1495
- “Variables Tab” on page 1-1495

Parameters Tab

Fluid chamber capacity

Amount of fluid that the accumulator can hold. The default value is $8e-3 \text{ m}^3$.

Preload pressure (gauge)

Spring pressure (gauge) when the fluid chamber is empty. The default value is $10e5 \text{ Pa}$.

Pressure at full capacity (gauge)

Spring pressure (gauge) when the fluid chamber is at capacity. The default value is $30e5 \text{ Pa}$.

Hard-stop stiffness coefficient

Proportionality constant of the hard-stop contact pressure with respect to the fluid volume penetrated into the hard stop. The hard stops are used to restrict the fluid volume between zero and fluid chamber capacity. The default value is $1e10 \text{ Pa/m}^3$.

Hard-stop damping coefficient

Proportionality constant of the hard-stop contact pressure with respect to the flow rate and the fluid volume penetrated into the hard stop. The hard stops are used to restrict the fluid volume between zero and fluid chamber capacity. The default value is $1e10 \text{ Pa*s/m}^6$.

Variables Tab

Accumulator flow rate

Volumetric flow rate through the accumulator port at time zero. Simscape software uses this parameter to guide the initial configuration of the component and model. Initial variables that

conflict with each other or are incompatible with the model may be ignored. Set the **Priority** column to **High** to prioritize this variable over other, low-priority, variables.

Volume of fluid

Volume of fluid in the accumulator at time zero. Simscape software uses this parameter to guide the initial configuration of the component and model. Initial variables that conflict with each other or are incompatible with the model may be ignored. Set the **Priority** column to **High** to prioritize this variable over other, low-priority, variables.

Pressure of liquid volume

Gauge pressure in the accumulator at time zero. Simscape software uses this parameter to guide the initial configuration of the component and model. Initial variables that conflict with each other or are incompatible with the model may be ignored. Set the **Priority** column to **High** to prioritize this variable over other, low-priority, variables.

Ports

The block has one hydraulic conserving port associated with the accumulator inlet.

The flow rate is positive if fluid flows into the accumulator.

Extended Capabilities**C/C++ Code Generation**

Generate C and C++ code using Simulink® Coder™.

See Also

Gas-Charged Accumulator

Topics

“Upgrading Simscape Fluids Models Containing Hydraulics (Isothermal) Blocks”

Introduced in R2006a

Sudden Area Change

Sudden enlargement or contraction



Library

Local Hydraulic Resistances

Description

The Sudden Area Change block represents a local hydraulic resistance, such as a sudden cross-sectional area change. The resistance represents a sudden enlargement if fluid flows from inlet to outlet, or a sudden contraction if fluid flows from outlet to inlet. The block is based on the Local Resistance block. It determines the pressure loss coefficient and passes its value to the underlying Local Resistance block. The block offers two methods of parameterization: by applying semi-empirical formulas (with a constant value of the pressure loss coefficient) or by table lookup for the pressure loss coefficient based on the Reynolds number.

If you choose to apply the semi-empirical formulas, you provide geometric parameters of the resistance, and the pressure loss coefficient is determined automatically according to the following equations (see [1] on page 1-1500):

$$K_{SE} = K_{cor} \left(1 - \frac{A_S}{A_L} \right)^2$$

$$K_{SC} = K_{cor} \cdot 0.5 \left(1 - \frac{A_S}{A_L} \right)^{0.75}$$

where

K_{SE}	Pressure loss coefficient for the sudden enlargement, which takes place if fluid flows from inlet to outlet
K_{SC}	Pressure loss coefficient for the sudden contraction, which takes place if fluid flows from outlet to inlet
K_{cor}	Correction factor
A_S	Small area
A_L	Large area

If you choose to specify the pressure loss coefficient by a table, you have to provide a tabulated relationship between the loss coefficient and the Reynolds number. In this case, the loss coefficient is determined by one-dimensional table lookup. You have a choice of two interpolation methods and two extrapolation methods.

The pressure loss coefficient, determined by either of the two methods, is then passed to the underlying Local Resistance block, which computes the pressure loss according to the formulas

explained in the reference documentation for that block. The flow regime is checked in the underlying Local Resistance block by comparing the Reynolds number to the specified critical Reynolds number value, and depending on the result, the appropriate formula for pressure loss computation is used.

The Sudden Area Change block is bidirectional and computes pressure loss for both the direct flow (sudden enlargement) and return flow (sudden contraction). If the loss coefficient is specified by a table, the table must cover both the positive and the negative flow regions.

Connections A and B are conserving hydraulic ports associated with the block inlet and outlet, respectively.

The block positive direction is from port A to port B. This means that the flow rate is positive if fluid flows from A to B, and the pressure loss is determined as $p = p_A - p_B$.

Basic Assumptions and Limitations

- Fluid inertia is not taken into account.
- If you select parameterization by the table-specified relationship $K=f(Re)$, the flow is assumed to be turbulent.

Parameters

Model parameterization

Select one of the following methods for block parameterization:

- **By semi-empirical formulas** — Provide geometrical parameters of the resistance. This is the default method.
- **Tabulated data – Loss coefficient vs. Reynolds number** — Provide tabulated relationship between the loss coefficient and the Reynolds number. The loss coefficient is determined by one-dimensional table lookup. You have a choice of two interpolation methods and two extrapolation methods. The table must cover both the positive and the negative flow regions.

Small diameter

Internal diameter of the small port, **A**. The default value is 0.01 m.

Large diameter

Internal diameter of the large port, **B**. The default value is 0.02 m. This parameter is used if **Model parameterization** is set to **By semi-empirical formulas**.

Correction coefficient

Correction factor used in the formula for computation of the loss coefficient. The default value is 1. This parameter is used if **Model parameterization** is set to **By semi-empirical formulas**.

Laminar transition specification

If **Model parameterization** is set to **By semi-empirical formulas**, select how the block transitions between the laminar and turbulent regimes:

- **Pressure ratio** — The transition from laminar to turbulent regime is smooth and depends on the value of the **Laminar flow pressure ratio** parameter. This method provides better simulation robustness.

- **Reynolds number** — The transition from laminar to turbulent regime is assumed to take place when the Reynolds number reaches the value specified by the **Critical Reynolds number** parameter.

Laminar flow pressure ratio

Pressure ratio at which the flow transitions between laminar and turbulent regimes. The default value is 0.999. This parameter is visible only if the **Laminar transition specification** parameter is set to **Pressure ratio**.

Critical Reynolds number

The maximum Reynolds number for laminar flow. The value of the parameter depends on the orifice geometrical profile. You can find recommendations on the parameter value in hydraulics textbooks. The default value is 110. This parameter is visible only if the **Laminar transition specification** parameter is set to **Reynolds number**.

Reynolds number vector

Specify the vector of input values for Reynolds numbers as a one-dimensional array. The input values vector must be strictly increasing. The values can be nonuniformly spaced. The minimum number of values depends on the interpolation method: you must provide at least two values for linear interpolation, at least three values for smooth interpolation. The default values are [-4000, -3000, -2000, -1000, -500, -200, -100, -50, -40, -30, -20, -15, -10, 10, 20, 30, 40, 50, 100, 200, 500, 1000, 2000, 4000, 5000, 10000]. This parameter is used if **Model parameterization** is set to **By loss coefficient vs. Re table**.

Loss coefficient vector

Specify the vector of the loss coefficient values as a one-dimensional array. The loss coefficient vector must be of the same size as the Reynolds numbers vector. The default values are [0.25, 0.3, 0.65, 0.9, 0.65, 0.75, 0.90, 1.15, 1.35, 1.65, 2.3, 2.8, 3.10, 5, 2.7, 1.8, 1.46, 1.3, 0.9, 0.65, 0.42, 0.3, 0.20, 0.40, 0.42, 0.25]. This parameter is used if **Model parameterization** is set to **By loss coefficient vs. Re table**.

Interpolation method

Select one of the following interpolation methods for approximating the output value when the input value is between two consecutive grid points:

- **Linear** — Select this option to get the best performance.
- **Smooth** — Select this option to produce a continuous curve with continuous first-order derivatives.

For more information on interpolation algorithms, see the PS Lookup Table (1D) block reference page. This parameter is used if **Model parameterization** is set to **By loss coefficient vs. Re table**.

Extrapolation method

Select one of the following extrapolation methods for determining the output value when the input value is outside the range specified in the argument list:

- **Linear** — Select this option to produce a curve with continuous first-order derivatives in the extrapolation region and at the boundary with the interpolation region.
- **Nearest** — Select this option to produce an extrapolation that does not go above the highest point in the data or below the lowest point in the data.

For more information on extrapolation algorithms, see the PS Lookup Table (1D) block reference page. This parameter is used if **Model parameterization** is set to `By loss coefficient vs. Re table`.

Restricted Parameters

When your model is in Restricted editing mode, you cannot modify the following parameters:

- **Model parameterization**
- **Interpolation method**
- **Extrapolation method**
- **Laminar transition specification**

All other block parameters are available for modification. The actual set of modifiable block parameters depends on the value of the **Model parameterization** parameter at the time the model entered Restricted mode.

Global Parameters

Parameters determined by the type of working fluid:

- **Fluid density**
- **Fluid kinematic viscosity**

Use the Hydraulic Fluid block or the Custom Hydraulic Fluid block to specify the fluid properties.

Ports

The block has the following ports:

A

Hydraulic conserving port associated with the resistance inlet.

B

Hydraulic conserving port associated with the resistance outlet.

References

[1] Idelchik, I.E., *Handbook of Hydraulic Resistance*, CRC Begell House, 1994

Extended Capabilities

C/C++ Code Generation

Generate C and C++ code using Simulink® Coder™.

See Also

Elbow | Gradual Area Change | Local Resistance | Pipe Bend | T-junction

Topics

“Upgrading Simscape Fluids Models Containing Hydraulics (Isothermal) Blocks”

Introduced in R2006b

Sudden Area Change (TL)

Sudden expansion or contraction in flow area

Library: Simscape / Fluids / Thermal Liquid / Pipes & Fittings



Description

The Sudden Area Change (TL) block models the minor pressure losses due to a sudden change in flow cross-sectional area. The area change is a contraction from port **A** to port **B** and an expansion from port **B** to port **A**. This component is adiabatic. It does not exchange heat with its surroundings.

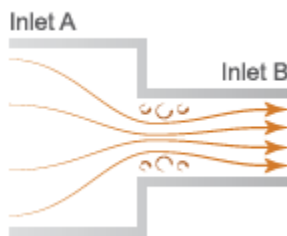

Sudden Area Change Schematic

The pressure drop across a sudden expansion is primarily due to turbulence mixing in the expansion zone. Across a sudden contraction, it is primarily due to flow detachment at the contraction zone entrance. The figure shows the expansion and contraction zones of the sudden area change.

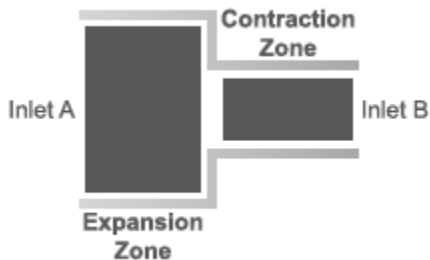

Mass Balance

The mass conservation equation in the sudden area change is

$$\dot{m}_A + \dot{m}_B = 0,$$

where:

- \dot{m}_A and \dot{m}_B are the mass flow rates into the sudden area change through ports A and B.

Momentum Balance

The momentum conservation equation in the sudden area change is

$$p_A - p_B = \frac{\dot{m}^2}{2\rho} \left(\frac{1}{S_B^2} - \frac{1}{S_A^2} \right) + \phi_{Loss},$$

where:

- p_A and p_B are the pressures at ports A and B.
- \dot{m} is the average mass flow rate.
- ρ is the average fluid density.
- S_A and S_B are the flow cross-sectional areas at ports A and B.
- ϕ_{Loss} is the mechanical energy loss due to the sudden area change.

The mechanical energy loss is

$$\phi_{Loss} = K_{Loss} \frac{\dot{m}^2}{2\rho S_B^2},$$

where:

- K_{Loss} is the loss coefficient.

If the **Loss coefficient specification** parameter is set to **Semi-empirical** formulation, the loss coefficient for a sudden expansion is computed as

$$K_{Loss} = K_e \left(1 - \frac{S_B}{S_A} \right)^2,$$

while for a sudden contraction it is computed as

$$K_{Loss} = \frac{K_c}{2} \left(1 - \frac{S_B}{S_A} \right),$$

where:

- K_e is the correction factor in the expansion zone.
- K_c is the correction factor in the contraction zone.

In the transition zone between sudden expansion and sudden contraction behavior, the loss coefficient is smoothed through a cubic polynomial function:

$$K_{Loss} = K_e \left(1 - \frac{S_B}{S_A} \right)^2 + \lambda \left[\frac{K_c}{2} \left(1 - \frac{S_B}{S_A} \right) - K_e \left(1 - \frac{S_B}{S_A} \right)^2 \right],$$

where

$$\lambda = 3\bar{m}^{-2} - 2\bar{m}^{-3},$$

and

$$\dot{m}_{Cr} = Re_{Cr} \sqrt{\frac{\pi}{4} S_B \mu}.$$

If the **Loss coefficient specification** parameter is set to **Tabulated data – Loss coefficient vs. Reynolds number**, the block obtains the loss coefficient from tabular data provided as a function of the Reynolds number.

Energy Balance

The energy conservation equation in the sudden area change is

$$\phi_A + \phi_B = 0,$$

where:

- Φ_A and Φ_B are the energy flow rates into the sudden area change through ports A and B.

Variables

Use the **Variables** tab to set the priority and initial target values for the block variables prior to simulation. For more information, see “Set Priority and Initial Target for Block Variables”.

Assumptions and Limitations

- The flow is incompressible. The fluid density is assumed constant in the sudden area change.

Ports

Conserving

A – Section inlet

thermal liquid

Fluid entry or exit point to the area change section.

B – Section inlet

thermal liquid

Fluid entry or exit point to the area change section.

Parameters

Local loss parameterization – Method of flow loss calculating

Semi-empirical (default) | Tabulated data - loss coefficient vs. Reynolds number

Parameterization for calculating the loss coefficient due to the sudden area change. Select **Semi-empirical** formulation to automatically compute the loss coefficient from the cross-sectional areas at ports **A** and **B**. Select **Tabulated data - Loss coefficient vs. Reynolds number** to specify a 1-D lookup table for the loss coefficient with respect to the flow Reynolds number.

Cross-sectional area at port A – Inlet area at A

0.02 m² (default) | positive scalar

Area normal to the direction of flow at inlet **A**. This value must be greater than the cross-sectional area at **B**.

Cross-sectional area at port B — Inlet area at B

0.01 m² (default) | positive scalar

Area normal to the direction of flow at **B**. This value must be smaller than the cross-sectional area at **A**.

Characteristic longitudinal length — Section characteristic length

0.1 m (default) | positive scalar

Average distance traversed by the fluid between ports **A** and **B**. This value must be greater than zero.

Critical Reynolds number — Transitional Reynolds number associated with smallest area in section

10 (default) | positive scalar

Reynolds number at which flow transitions between laminar and turbulent regimes in the contraction portion of the sudden area change. This parameter is visible only when the **Loss coefficient specification** parameter is set to Semi-empirical formulation.

Contraction correction factor — Loss coefficient scaling factor

1 (default) | positive scalar

Scaling factor for adjusting the loss coefficient value in the contraction portion of the sudden area change. The block multiplies the loss coefficient factor calculated from the semi-empirical expression by this factor. This parameter is visible only when the **Loss coefficient specification** parameter is set to Semi-empirical formulation.

Expansion correction factor — Loss coefficient scaling factor

1 (default) | positive scalar

Scaling factor for adjusting the loss coefficient value in the expansion portion of the sudden area change. The block multiplies the loss coefficient factor calculated from the semi-empirical expression by this factor. This parameter is visible only when the **Loss coefficient specification** parameter is set to Semi-empirical formulation.

Reynolds number vector — Vector of Reynolds numbers for tabular parameterization

[10, 20, 30, 40, 50, 100, 200, 500, 1000, 2000] (default) | vector

Vector of Reynolds numbers for the tabular parameterization of loss coefficients. You specify the **Contraction loss coefficient vector** and **Expansion loss coefficient vector** parameters at these Reynolds numbers.

This parameter is visible only when the **Loss coefficient specification** parameter is set to Tabulated data - Loss coefficient vs. Reynolds number.

Contraction loss coefficient vector — Vector of loss coefficients for tabular parameterization

[4, 2.7, 1.8, 1.46, 1.3, .9, .65, .42, .3, .2] (default) | 1-by-*n* vector

Vector of loss coefficients for the contraction portion of the area change. Specify the loss coefficients at the Reynolds numbers in the **Reynolds number vector** parameter. The block uses the Reynolds number and loss coefficient vectors to construct a 1-D lookup table.

This parameter is visible only when the **Loss coefficient specification** parameter is set to Tabulated data – Loss coefficient vs. Reynolds number.

Expansion loss coefficient vector – Vector of loss coefficients for tabular parameterization

[4, 2.3, 1.65, 1.35, 1.15, .9, .75, .65, .9, .65] (default) | 1-by-*n* vector

Vector of loss coefficients for the expansion portion of the area change. Specify the loss coefficients at the Reynolds numbers in the **Reynolds number vector** parameter. The block uses the Reynolds number and loss coefficient vectors to construct a 1-D lookup table.

This parameter is visible only when the **Loss coefficient specification** parameter is set to Tabulated data – Loss coefficient vs. Reynolds number.

Extended Capabilities

C/C++ Code Generation

Generate C and C++ code using Simulink® Coder™.

See Also

Pipe (TL)

Introduced in R2016a

Swash Plate

Swash plate mechanism



Library

Pumps and Motors

Description

Note that this reference page is for the Hydraulics (Isothermal) Liquid library block. For the Isothermal Liquid library block, see Swash Plate.

The Swash Plate block is a model of a swash plate mechanism used in axial-piston hydraulic pumps and motors to convert translational motion of a piston into rotational motion of a drive shaft. The mechanism is a combination of a cylinder block or rotor, with the piston fitted inside, and an angled swash plate.

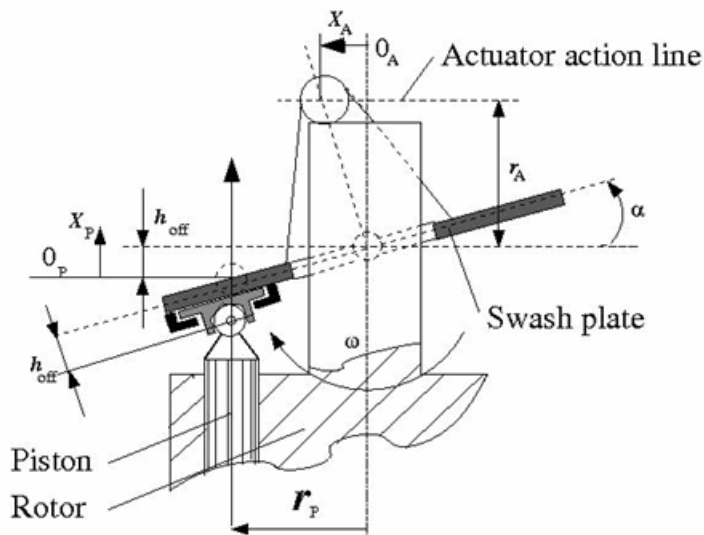

The angular position of the plate is controlled by an actuator, usually a servo cylinder, acting along the actuator action line (marked in the preceding diagram). The distance between the actuator line and the swash plate at zero angle is equal to the actuator arm length r_A . The pistons are offset by h_{off} from the swash plate. The swash plate angle can be changed to increase or decrease the piston stroke. As the rotor turns, the piston slides on the swash plate, which causes the piston to reciprocate. The sliding contact between the piston and the swash plate is maintained by the guideway shown in the diagram.

In a hydraulic machine, the piston moves along the slots in the porting plate (not shown in the preceding diagram) thus being periodically connected to either the intake or the discharge port of the machine. The model simulates a single piston interacting with the swash plate. Mechanically, the mechanism performs summation of two motions, caused by rotation of the swash plate with respect to its axis and rotation of the rotor, and converts them into displacement of the piston.

The following illustration shows the calculation diagram of the mechanism.

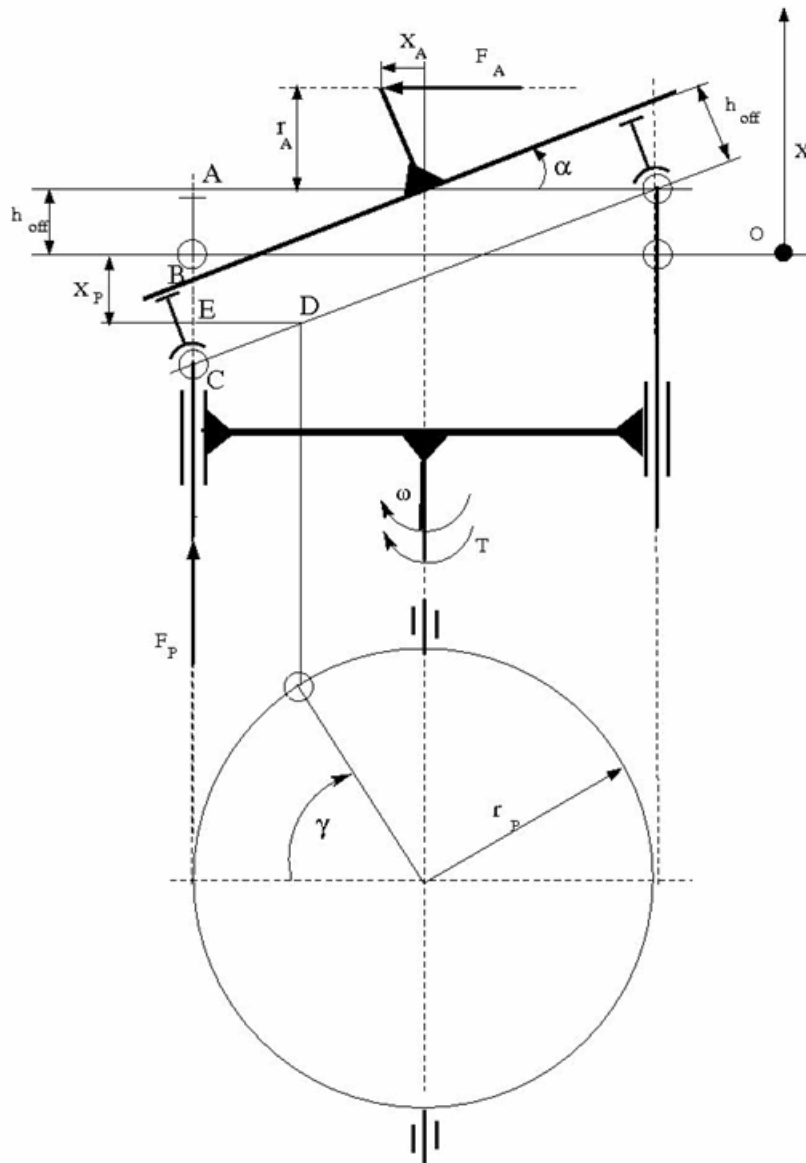

The positive direction of the actuator is assumed to be directed to the left from the vertical axis, while the positive direction of the piston motion is directed upward, as it is shown in the diagram. The reference point for both motions corresponds to the plate being perpendicular to the rotor axis. As far as the angular motion of the rotor is concerned, the clockwise rotation (looking from the top) is assumed to be positive.

The piston displacement at arbitrary rotor rotation angle γ and actuator displacement x_A is determined from the relationship:

$$x_P = -(AB - h_{off} + BC + DE \cdot tg\alpha)$$

$$tg\alpha = \frac{x_A}{r_A}$$

which, after minor rearrangement, yields:

$$x_P = -\frac{r_P}{r_A}x_A \cos(\gamma + \beta) - h_{off} \left(\sqrt{1 + \frac{x_A^2}{r_A^2}} - 1 \right) \quad (1-12)$$

$$\gamma = \omega \cdot t$$

where

x_P	Piston displacement
x_A	Actuator displacement
r_P	Cylinder block pitch radius
r_A	Actuator arm
γ	Rotor angle of rotation
h_{off}	Piston offset
β	Piston phase angle
ω	Rotor angular velocity
t	Time

The kinematic relationship between piston and actuator displacement must be converted into a relationship between the basic Across variables for the physical network representation, that is, velocities:

$$V_P = \frac{dx_P}{dt} = -\frac{r_P}{r_A}V_A \cos(\gamma + \beta) + \frac{r_P}{r_A}x_A \omega \sin(\gamma + \beta) - \frac{h_{off}}{r_A^2} \frac{x_A V_A}{\sqrt{1 + \frac{x_A^2}{r_A^2}}}$$

where

V_P	Piston velocity
V_A	Actuator velocity

The inertia properties of the mechanism are assumed to be negligible. Therefore, any state of the mechanism can be considered as equilibrium. According to the principle of virtual work, if the system is in equilibrium the aggregate work of all the applied forces and torques on the system virtual displacements is equal to zero. For the mechanism under consideration, the principle of virtual work yields:

$$F_P \delta x_P + F_A \delta x_A + (T - T_{res}) \delta \gamma = 0 \quad (1-13)$$

where

F_P	Piston force
F_A	Actuator force
T	Rotor torque
T_{res}	Resistance torque acting on the rotor due to viscous friction

Virtual displacements δx_P , δx_A , and $\delta \gamma$ are determined from “Equation 1-12” and substituted into “Equation 1-13”. Since virtual displacements δx_A and $\delta \gamma$ are independent, any of them can be equal to zero. As a result, we obtain two more equations of the mechanism:

$$F_A = \frac{r_P}{r_A} F_P \cos(\gamma + \beta) + \frac{h_{off}}{r_A^2} \frac{x_A}{\sqrt{1 + \frac{x_A^2}{r_A^2}}} F_P$$

$$T = -\frac{r_P}{r_A} x_A \cdot F_P \cdot \sin(\gamma + \beta) + T_{res}$$

The resistance torque is:

$$T_{res} = \mu \cdot r_P \cdot \omega$$

where μ is the viscous friction coefficient in the contact between the piston and the plate.

The final set of equations describing the swash plate mechanism takes the form:

$$V_P = \frac{dx_P}{dt} = -\frac{r_P}{r_A} V_A \cos(\gamma + \beta) + \frac{r_P}{r_A} x_A \omega \sin(\gamma + \beta) - \frac{h_{off}}{r_A^2} \frac{x_A V_A}{\sqrt{1 + \frac{x_A^2}{r_A^2}}}$$

$$F_A = \frac{r_P}{r_A} F_P \cos(\gamma + \beta) + \frac{h_{off}}{r_A^2} \frac{x_A}{\sqrt{1 + \frac{x_A^2}{r_A^2}}} F_P$$

$$T = -\frac{r_P}{r_A} x_A \cdot F_P \cdot \sin(\gamma + \beta) + \mu \cdot r_P \cdot F_P$$

Connection P is a mechanical translational conserving port associated with the tip of the piston. Connection S is a mechanical rotational conserving port associated with the drive shaft, which is connected to the cylinder block. Connection A is a mechanical translational conserving port associated with the swash plate actuator.

Basic Assumptions and Limitations

- The model accounts for the viscous friction in the piston-plate contact.
- No inertial effects are considered.
- The plate angular displacements are considered to be small.
- The joint between the piston and the plate permanently maintains contact between the piston and the plate.

Parameters

Swash plate actuator arm

The distance between the actuator line of action and the center of the rotor rotation. The parameter must be greater than zero. The default value is 0.065 m.

Piston pitch radius

The radius of the pitch circle where the pistons are located, that is, the cylinder block pitch radius. The parameter must be greater than zero. The default value is 0.05 m.

Piston offset from the plate

The offset between the piston tip and the swash plate. The parameter must be greater than or equal to zero. The default value is 0.

Phase angle

Parameter sets the piston initial angular position with respect to the reference point which corresponds to the zero angle. The default value is 0.

Actuator initial displacement

Parameter sets the initial position of the actuator with respect to the reference point which corresponds to the plate being perpendicular to the axis of rotor rotation. The default value is 0.

Viscous friction coefficient

The parameter specifies the coefficient of viscous friction in the contact between the piston and the plate. The parameter must be greater than zero. The default value is 50 N/(m/s).

Ports

The block has the following ports:

A

Mechanical translational conserving port associated with the actuator joint.

P

Mechanical translational conserving port associated with the tip of the piston.

S

Mechanical rotational conserving port associated with the drive shaft.

Examples

The “Hydraulic Axial-Piston Pump with Load-Sensing and Pressure-Limiting Control” example models a test rig designed to investigate interaction between an axial-piston pump and a typical control unit, simultaneously performing the load-sensing and pressure-limiting functions. To assure required accuracy, the model of the pump must account for such features as interaction between pistons, swash plate, and porting plate, which makes it necessary to build a detailed pump model.

Extended Capabilities

C/C++ Code Generation

Generate C and C++ code using Simulink® Coder™.

See Also

Porting Plate Variable Orifice

Topics

“Upgrading Simscape Fluids Models Containing Hydraulics (Isothermal) Blocks”

Introduced in R2011a

Swash Plate

Swash plate in a single-piston, isothermal axial piston pump

Library: Simscape / Fluids / Isothermal Liquid / Pumps & Motors /
Auxiliary Components



Description

The Swash Plate block models a single, piston-actuated swash plate within an axial-piston pump. It translates linear actuation into rotational motion that, when connected to the Valve Plate Orifice (IL) block, periodically connects the piston with the pump intake and discharge. You can connect multiple swash plate blocks to multiple pistons.

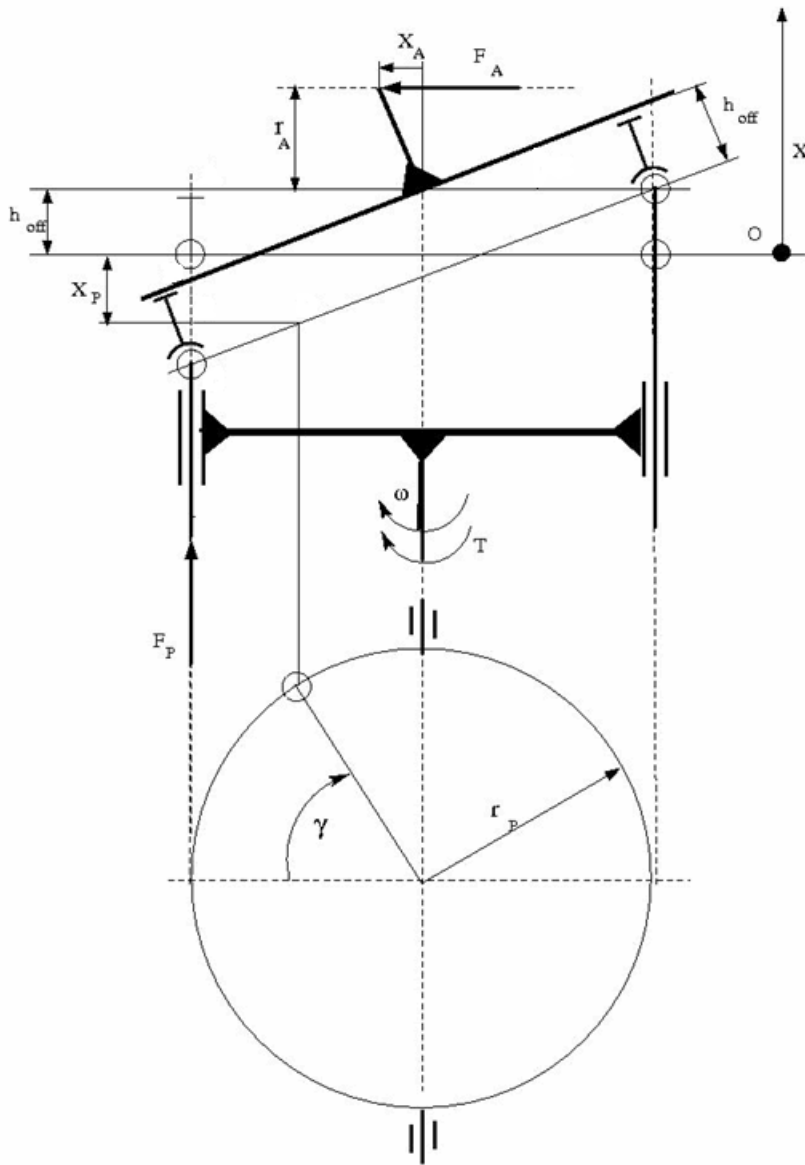

Schematic of a Swash Plate Within an Axial-Piston Pump Unit

Force Balance

The plate is in dynamic equilibrium if the net work by the piston, actuator, and plate is zero:

$$F_P \delta_P + F_A \delta_A + (\tau - \tau_{res}) \delta_y = 0,$$

where:

- $F_P \delta_P$ is the work done due to piston displacement.
- $F_A \delta_A$ is the work done due to actuator displacement.
- $(\tau - \tau_{res}) \delta_y$ is the work done due to the net plate torque tangent to plate motion.

The plate torque is:

$$\tau = -\frac{r_P}{r_A}x_A F_P \sin\gamma + \tau_{res},$$

where:

- r_P is the **Cylinder block pitch radius**.
- r_A is the **Swash plate actuator arm**.
- X_A is the actuator displacement.
- F_P is the piston force.
- γ is the plate angular displacement.

The viscous friction torque, or the resistance to motion due to plate-piston contact, is:

$$\tau_{res} = \mu_{viscous}\omega r_P^2,$$

where:

- $\mu_{viscous}$ is the **Viscous friction coefficient**.
- ω is the rotor angular velocity.

Piston Dynamics

The piston displacement, x , is proportional to the actuator displacement:

$$x = -h_{off}\left(\sqrt{1 + \frac{x_A^2}{r_A^2}} - 1\right) - \frac{r_P}{r_A}x_A \cos\gamma,$$

where h_{off} is the **Piston offset from the plate**. Displacement is positive if it moves toward the cylinder block.

The piston velocity is:

$$V_P = \frac{r_P}{r_A}x_A\omega\sin(\gamma) - \frac{r_P}{r_A}V_A\cos\gamma - \frac{h_{off}}{r_A^2} \frac{x_A V_A}{\sqrt{1 + \frac{x_A^2}{r_A^2}}},$$

where V_A is the actuator velocity.

Assumptions and Limitations

This block accounts for the effect of viscous friction between the piston and plate, but neglects plate and fluid inertia.

Note This reference page is for the Isothermal Liquid library block. For the Hydraulics (Isothermal) Liquid library block, see Swash Plate.

Ports

Conserving

A – Mechanical port associated with actuator

mechanical translational

Swash plate actuator velocity and force.

P – Mechanical port associated with piston

mechanical translational

Piston end velocity and force.

S – Mechanical port associated with shaft

mechanical rotational

Drive shaft angular velocity and torque. Rotation is relative to the environment.

Parameters

Swash plate actuator arm – Length of actuator extension

0.065 m (default) | positive scalar

Length of fully extended actuator arm.

Cylinder block pitch radius – Cylinder pitch radius

0.05 m (default) | positive scalar

Pitch radius of the rotating cylinder.

Piston offset from the plate – Resting piston offset

0 m (default) | scalar

Piston offset when the actuator is in neutral position. A positive, nonzero value indicates a partially retracted piston. A negative, nonzero value indicates an extended piston that remains within the cylinder block during an initial actuator displacement away from the cylinder.

Viscous friction coefficient – Torque viscous friction coefficient

50 N/(m/s) (default) | positive scalar

Coefficient used in the equation for torque due to viscous friction.

Extended Capabilities

C/C++ Code Generation

Generate C and C++ code using Simulink® Coder™.

See Also

Valve Plate Orifice (IL)

Introduced in R2020a

System-Level Condenser Evaporator (2P-MA)

Heat exchanger between two-phase fluid and moist air networks, with model based on performance data

Library: Simscape / Fluids / Fluid Network Interfaces / Heat Exchangers

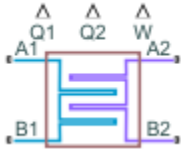

Description

The System-Level Condenser Evaporator (2P-MA) block models a heat exchanger between a two-phase fluid network and a moist air network.

The block can act as a condenser or as an evaporator in a refrigeration system, depending on the direction of heat transfer. The block model is based on performance data from the heat exchanger datasheet, rather than on the detailed geometry of the exchanger, and therefore lets you easily adjust the size and performance of the heat exchanger during design iterations, or model heat exchangers with uncommon geometries. You can also use this block to model heat exchangers with a certain level of performance at an early design stage, when detailed geometry data is not yet available.

You parameterize the block by the nominal operating condition. The heat exchanger is sized to match the specified performance at the nominal operating condition at steady state.

The Two-Phase Fluid 1 side approximates the liquid zone, mixture zone, and vapor zone based on the change in enthalpy along the flow path. The Moist Air 2 side models water vapor condensation based on convective water vapor mass transfer with the heat transfer surface. Condensed water is removed from the moist air flow.

This block is similar to the Condenser Evaporator (2P-MA) block but uses a different parameterization model. The table provides a comparison of the two blocks, to help you choose the right block for your application.

Condenser Evaporator (2P-MA)	System-Level Condenser Evaporator (2P-MA)
Block parameters are based on the heat exchanger geometry	Block parameters are based on performance and operating conditions
Heat exchanger geometry may be limited by the available geometry parameter options	Model is independent of the specific heat exchanger geometry
You can adjust the block for different performance requirements by tuning geometry parameters, such as fin sizes and tube lengths	You can adjust the block for different performance requirements by directly specifying the desired heat and mass flow rates
Lets you select between parallel, counter, or cross flow configurations	Does not provide a choice of flow arrangement options

Condenser Evaporator (2P-MA)	System-Level Condenser Evaporator (2P-MA)
Predictively accurate results over a wide range of operating conditions, subject to the applicability of the E-NTU equations and the heat transfer coefficient correlations	Very accurate results around the specified operating condition; accuracy may decrease far away from the specified operating conditions
Heat transfer calculations account for the variation of temperature along the flow path by using the E-NTU model	Heat transfer calculations approximate the variation of temperature along the flow path by dividing it into three segments
Accounts for different fluid properties and heat transfer coefficients for subcooled liquid, liquid-vapor mixture, and superheated vapor	Accounts for different fluid properties and heat transfer coefficients for subcooled liquid, liquid-vapor mixture, and superheated vapor
Keeps track of variable zone length fractions for subcooled liquid, liquid-vapor mixture, and superheated vapor regions based on the geometry	Approximates the effect of subcooled liquid, liquid-vapor mixture, and superheated vapor regions using weighting factors based on the difference in enthalpy between inlet and outlet
Accounts for water vapor condensation and the latent heat on the moist air flow	Accounts for water vapor condensation and the latent heat on the moist air flow
Does not model the wall thermal mass; you can approximate the effect by connecting a pipe block with a thermal mass downstream	Includes an option to model the wall thermal mass

Heat Transfer

The two-phase fluid flow and the moist air flow are each divided into three segments of equal size. Heat transfer between the fluids is calculated in each segment. For simplicity, the equation for one segment is shown here.

If the wall thermal mass is off, then the heat balance in the heat exchanger is

$$Q_{seg, 2P} + Q_{seg, MA} = 0,$$

where:

- $Q_{seg, 2P}$ is the heat flow rate from the wall (that is, the heat transfer surface) to the two-phase fluid in the segment.
- $Q_{seg, MA}$ is the heat flow rate from the wall to the moist air in the segment.

If the wall thermal mass is on, then the heat balance in the heat exchanger is

$$Q_{seg, 2P} + Q_{seg, MA} = - \frac{M_{wall} c_{p, wall}}{N} \frac{dT_{seg, wall}}{dt},$$

where:

- M_{wall} is the mass of the wall.
- $c_{p, wall}$ is the specific heat of the wall.
- $N = 3$ is the number of segments.
- $T_{seg, wall}$ is the average wall temperature in the segment.
- t is time.

The heat flow rate from the wall to the two-phase fluid in the segment is

$$Q_{seg, 2P} = UA_{seg, 2P}(T_{seg, wall} - T_{seg, 2P}),$$

where:

- $UA_{seg, 2P}$ is the weighted-average heat transfer conductance for the two-phase fluid in the segment.
- $T_{seg, 2P}$ is the weighted-average fluid temperature for the two-phase fluid in the segment.

The heat flow rate from the wall to the moist air in the segment is

$$Q_{seg, MA} = \frac{UA_{seg, MA}}{\bar{c}_{pseg, MA}}(\bar{h}_{seg, wall} - \bar{h}_{seg, MA}) + \dot{m}_{w, seg, cond}h_{l, wall}$$

where:

- $UA_{seg, MA}$ is the heat transfer conductance for the moist air in the segment.
- $\bar{c}_{pseg, MA}$ is the moist air mixture specific heat per unit mass of dry air and trace gas in the segment.
- $\bar{h}_{seg, wall}$ is the moist air mixture enthalpy per unit mass of dry air and trace gas at the average wall segment temperature.
- $\bar{h}_{seg, MA}$ is the moist air mixture enthalpy per unit mass of dry air and trace gas in the segment.
- $\dot{m}_{w, seg, cond}$ is the rate of water vapor condensation on the wall surface.
- $h_{l, wall}$ is the specific enthalpy of liquid water at the average wall segment temperature.

Using mixture enthalpy in this equation accounts for both differences in temperature and differences in moisture due to condensation [3].

Note For the moist air quantities, the bar above the symbols indicates that they are quantities for mixture divided by the mass of dry air and trace gas only, as opposed to dividing by the mass of the whole mixture. The whole mixture includes dry air, water vapor, and trace gas.

Two-Phase Fluid Heat Transfer Correlation

If the segment is subcooled liquid, then the heat transfer conductance is

$$UA_{seg, L, 2P} = a_{L, 2P}(Re_{seg, L, 2P})^{b_{2P}}(Pr_{seg, L, 2P})^{c_{2P}}k_{seg, L, 2P}\frac{G_{2P}}{N},$$

where:

- $a_{L, 2P}$, b_{2P} , and c_{2P} are the coefficients of the Nusselt number correlation. These coefficients appear as block parameters in the **Correlation Coefficients** section.
- $Re_{seg, L, 2P}$ is the average liquid Reynolds number for the segment.
- $Pr_{seg, L, 2P}$ is the average liquid Prandtl number for the segment.
- $k_{seg, L, 2P}$ is the average liquid thermal conductivity for the segment.
- G_{2P} is the geometry scale factor for the two-phase fluid side of the heat exchanger. The block calculates the geometry scale factor so that the total heat transfer over all segments matches the specified performance at the nominal operating conditions.

The average liquid Reynolds number is

$$Re_{seg,L,2P} = \frac{\dot{m}_{seg,2P} D_{ref,2P}}{\mu_{seg,L,2P} S_{ref,2P}}$$

where:

- $\dot{m}_{seg,2P}$ is the mass flow rate through the segment.
- $\mu_{seg,L,2P}$ is the average liquid dynamic viscosity for the segment.
- $D_{ref,2P}$ is an arbitrary reference diameter.
- $S_{ref,2P}$ is an arbitrary reference flow area.

Note The $D_{ref,2P}$ and $S_{ref,2P}$ terms are included in this equation for unit calculation purposes only, to make $Re_{seg,L,2P}$ nondimensional. The values of $D_{ref,2P}$ and $S_{ref,2P}$ are arbitrary because the G_{2P} calculation overrides these values.

Similarly, if the segment is superheated vapor, then the heat transfer conductance is

$$UA_{seg,V,2P} = a_{V,2P} (Re_{seg,V,2P})^{b_{2P}} (Pr_{seg,V,2P})^{c_{2P}} k_{seg,V,2P} \frac{G_{2P}}{N}$$

where:

- $a_{V,2P}$, b_{2P} , and c_{2P} are the coefficients of the Nusselt number correlation. These coefficients appear as block parameters in the **Correlation Coefficients** section.
- $Re_{seg,V,2P}$ is the average vapor Reynolds number for the segment.
- $Pr_{seg,V,2P}$ is the average vapor Prandtl number for the segment.
- $k_{seg,V,2P}$ is the average vapor thermal conductivity for the segment.

The average vapor Reynolds number is

$$Re_{seg,V,2P} = \frac{\dot{m}_{seg,2P} D_{ref,2P}}{\mu_{seg,V,2P} S_{ref,2P}}$$

where $\mu_{seg,V,2P}$ is the average vapor dynamic viscosity for the segment.

If the segment is liquid-vapor mixture, then the heat transfer conductance is

$$UA_{seg,M,2P} = a_{M,2P} (Re_{seg,SL,2P})^{b_{2P}} CZ (Pr_{seg,SL,2P})^{c_{2P}} k_{seg,SL,2P} \frac{G_{2P}}{N}$$

where:

- $a_{M,2P}$, b_{2P} , and c_{2P} are the coefficients of the Nusselt number correlation. These coefficients appear as block parameters in the **Correlation Coefficients** section.
- $Re_{seg,SL,2P}$ is the saturated liquid Reynolds number for the segment.
- $Pr_{seg,SL,2P}$ is the saturated liquid Prandtl number for the segment.
- $k_{seg,SL,2P}$ is the saturated liquid thermal conductivity for the segment.
- CZ is the Cavallini and Zecchin term.

The saturated liquid Reynolds number is

$$Re_{seg, SL, 2P} = \frac{\dot{m}_{seg, 2P} D_{ref, 2P}}{\mu_{seg, SL, 2P} S_{ref, 2P}},$$

where $\mu_{seg, SL, 2P}$ is the saturated liquid dynamic viscosity for the segment.

The Cavallini and Zecchin term is

$$CZ = \frac{\left(\left(\sqrt{\frac{\nu_{seg, SV, 2P}}{\nu_{seg, SL, 2P}}} - 1 \right) (x_{seg, out, 2P} + 1) \right)^{1 + b_{2P}} - \left(\left(\sqrt{\frac{\nu_{seg, SV, 2P}}{\nu_{seg, SL, 2P}}} - 1 \right) (x_{seg, in, 2P} + 1) \right)^{1 + b_{2P}}}{(1 + b_{2P}) \left(\sqrt{\frac{\nu_{seg, SV, 2P}}{\nu_{seg, SL, 2P}}} - 1 \right) (x_{seg, out, 2P} - x_{seg, in, 2P})},$$

where:

- $\nu_{seg, SL, 2P}$ is the saturated liquid specific volume for the segment.
- $\nu_{seg, SV, 2P}$ is the saturated vapor specific volume for the segment.
- $x_{seg, in, 2P}$ is the vapor quality at the segment inlet.
- $x_{seg, out, 2P}$ is the vapor quality at the segment outlet.

The expression is based on the work of Cavallini and Zecchin [5], which derives a heat transfer coefficient correlation at a local vapor quality x . Equations for the liquid-vapor mixture are obtained by averaging Cavallini and Zecchin's correlation over the segment from $x_{seg, in, 2P}$ to $x_{seg, out, 2P}$.

Two-Phase Fluid Weighted Average

The two-phase fluid flow through a segment may not be entirely represented as either subcooled liquid, superheated vapor, or liquid-vapor mixture. Instead, each segment may consist of a combination of these. The block approximates this condition by computing weighting factors based on the change in specific enthalpy across the segment and the saturated liquid and vapor specific enthalpies:

$$w_L = \frac{|\min(h_{seg, out, 2P}, h_{seg, SL, 2P}) - \min(h_{seg, in, 2P}, h_{seg, SL, 2P})|}{|h_{seg, out, 2P} - h_{seg, in, 2P}|}$$

$$w_V = \frac{|\max(h_{seg, out, 2P}, h_{seg, SV, 2P}) - \max(h_{seg, in, 2P}, h_{seg, SV, 2P})|}{|h_{seg, out, 2P} - h_{seg, in, 2P}|}$$

$$w_M = 1 - w_L - w_V$$

where:

- $h_{seg, in, 2P}$ is the specific enthalpy at the segment inlet.
- $h_{seg, out, 2P}$ is the specific enthalpy at the segment outlet.
- $h_{seg, SL, 2P}$ is the saturated liquid specific enthalpy for the segment.
- $h_{seg, SV, 2P}$ is the saturated vapor specific enthalpy for the segment.

The weighted-average two-phase fluid heat transfer conductance for the segment is therefore

$$UA_{seg, 2P} = w_L(UA_{seg, L, 2P}) + w_V(UA_{seg, V, 2P}) + w_M(UA_{seg, M, 2P}).$$

The weighted-average fluid temperature for the segment is

$$T_{seg, 2P} = \frac{w_L(UA_{seg, L, 2P})T_{seg, L, 2P} + w_V(UA_{seg, V, 2P})T_{seg, V, 2P} + w_M(UA_{seg, M, 2P})T_{seg, M, 2P}}{UA_{seg, 2P}},$$

where:

- $T_{seg, L, 2P}$ is the average liquid temperature for the segment.
- $T_{seg, V, 2P}$ is the average vapor temperature for the segment.
- $T_{seg, M, 2P}$ is the average mixture temperature for the segment, which is the saturated liquid temperature.

Moist Air Heat Transfer Correlation

The heat transfer conductance is

$$UA_{seg, MA} = a_{MA}(Re_{seg, MA})^{b_{MA}}(Pr_{seg, MA})^{c_{MA}}k_{seg, MA}\frac{G_{MA}}{N},$$

where:

- a_{MA} , b_{MA} , and c_{MA} are the coefficients of the Nusselt number correlation. These coefficients appear as block parameters in the **Correlation Coefficients** section.
- $Re_{seg, MA}$ is the average Reynolds number for the segment.
- $Pr_{seg, MA}$ is the average Prandtl number for the segment.
- $k_{seg, MA}$ is the average thermal conductivity for the segment.
- G_{MA} is the geometry scale factor for the moist air side of the heat exchanger. The block calculates the geometry scale factor so that the total heat transfer over all segments matches the specified performance at the nominal operating conditions.

The average Reynolds number is

$$Re_{seg, MA} = \frac{\dot{m}_{seg, MA}D_{ref, MA}}{\mu_{seg, MA}S_{ref, MA}},$$

where:

- $\dot{m}_{seg, MA}$ is the mass flow rate through the segment.
- $\mu_{seg, MA}$ is the average dynamic viscosity for the segment.
- $D_{ref, MA}$ is an arbitrary reference diameter.
- $S_{ref, MA}$ is an arbitrary reference flow area.

Note The $D_{ref, MA}$ and $S_{ref, MA}$ terms are included in this equation for unit calculation purposes only, to make $Re_{seg, MA}$ nondimensional. The values of $D_{ref, MA}$ and $S_{ref, MA}$ are arbitrary because the G_{MA} calculation overrides these values.

Moist Air Condensation

The equation describing the heat flow rate from the wall to the moist air in the segment (the last equation in the “Heat Transfer” on page 1-1518 section) uses the average moist air mixture enthalpy, $\bar{h}_{seg, MA}$, and the wall segment moist air mixture enthalpy, $\bar{h}_{seg, wall}$.

The average moist air mixture enthalpy is based on the temperature and humidity of the moist air flow through the segment:

$$\bar{h}_{seg, MA} = h_{seg, ag, MA} + W_{seg, MA} h_{seg, w, MA},$$

where:

- $h_{seg, ag, MA}$ is the average specific enthalpy of dry air and trace gas for the segment.
- $h_{seg, w, MA}$ is the average specific enthalpy of water vapor for the segment.
- $W_{seg, MA}$ is the humidity ratio of the segment.

The wall segment moist air mixture enthalpy is based on the temperature and humidity at the wall segment:

$$\bar{h}_{seg, wall} = h_{seg, ag, wall} + W_{seg, wall} h_{seg, w, wall},$$

where:

- $h_{seg, ag, wall}$ is the specific enthalpy of dry air and trace gas at the wall segment temperature.
- $h_{seg, w, wall}$ is the specific enthalpy of water vapor at the wall segment temperature.
- $W_{seg, wall}$ is the humidity ratio at the wall segment:

$$W_{seg, wall} = \min(W_{seg, MA}, W_{seg, s, wall}),$$

where $W_{seg, s, wall}$ is the saturated humidity ratio at the wall segment temperature. In other words, the humidity ratio at the wall is the same as the humidity ratio of the moist air flow but not more than the maximum that can be supported at the wall segment temperature.

When $W_{seg, s, wall} < W_{seg, MA}$, water vapor condensation occurs on the wall surface. The rate of water vapor condensation is

$$\dot{m}_{w, seg, cond} = \frac{UA_{seg, MA}}{\bar{c}_{pseg, MA}} (W_{seg, MA} - W_{seg, wall}).$$

The condensed water is assumed to be drained from the wall surface and is thus removed from the moist air flow downstream.

Pressure Loss

The pressure losses on the two-phase fluid side are

$$p_{A, 2P} - p_{2P} = \frac{K_{2P} \dot{m}_{A, 2P} \sqrt{\dot{m}_{A, 2P}^2 + \dot{m}_{thres, 2P}^2}}{2 \rho_{avg, 2P}}$$

$$p_{B, 2P} - p_{2P} = \frac{K_{2P} \dot{m}_{B, 2P} \sqrt{\dot{m}_{B, 2P}^2 + \dot{m}_{thres, 2P}^2}}{2 \rho_{avg, 2P}}$$

where:

- $p_{A, 2P}$ and $p_{B, 2P}$ are the pressures at ports **A1** and **B1**, respectively.
- p_{2P} is internal two-phase fluid pressure at which the heat transfer is calculated.

- $\dot{m}_{A,2P}$ and $\dot{m}_{B,2P}$ are the mass flow rates into ports **A1** and **B1**, respectively.
- $\rho_{avg,2P}$ is the average two-phase fluid density over all segments.
- $\dot{m}_{thres,2P}$ is the laminar threshold for pressure loss, approximated as 1e-4 of the nominal mass flow rate. The block calculates the pressure loss coefficient, K_{2P} , so that $p_{A,2P} - p_{B,2P}$ matches the nominal pressure loss at the nominal mass flow rate.

The pressure losses on the moist air side are

$$p_{A,MA} - p_{MA} = \frac{K_{MA} \dot{m}_{A,MA} \sqrt{\dot{m}_{A,MA}^2 + \dot{m}_{thres,MA}^2}}{2 \rho_{avg,2P}}$$

$$p_{B,MA} - p_{MA} = \frac{K_{MA} \dot{m}_{B,MA} \sqrt{\dot{m}_{B,MA}^2 + \dot{m}_{thres,MA}^2}}{2 \rho_{avg,MA}}$$

where:

- $p_{A,MA}$ and $p_{B,MA}$ are the pressures at ports **A2** and **B2**, respectively.
- p_{MA} is internal moist air pressure at which the heat transfer is calculated.
- $\dot{m}_{A,MA}$ and $\dot{m}_{B,MA}$ are the mass flow rates into ports **A2** and **B2**, respectively.
- $\rho_{avg,MA}$ is the average moist air density over all segments.
- $\dot{m}_{thres,MA}$ is the laminar threshold for pressure loss, approximated as 1e-4 of the nominal mass flow rate. The block calculates the pressure loss coefficient, K_{MA} , so that $p_{A,MA} - p_{B,MA}$ matches the nominal pressure loss at the nominal mass flow rate.

Two-Phase Fluid Mass and Energy Conservation

The mass conservation equation for the overall two-phase fluid flow is

$$\left(\frac{dp_{2P}}{dt} \sum_{segments} \left(\frac{\partial \rho_{seg,2P}}{\partial p} \right) + \sum_{segments} \left(\frac{du_{seg,2P}}{dt} \frac{\partial \rho_{seg,2P}}{\partial u} \right) \right) \frac{V_{2P}}{N} = \dot{m}_{A,2P} + \dot{m}_{B,2P},$$

where:

- $\frac{\partial \rho_{seg,2P}}{\partial p}$ is the partial derivative of density with respect to pressure for the segment.
- $\frac{\partial \rho_{seg,2P}}{\partial u}$ is the partial derivative of density with respect to specific internal energy for the segment.
- $u_{seg,2P}$ is the specific internal energy for the segment.
- V_{2P} is the total two-phase fluid volume.

The summation is over all segments.

Note Although the two-phase fluid flow is divided into $N=3$ segments for heat transfer calculations, all segments are assumed to be at the same internal pressure, p_{2P} . That is why p_{2P} is outside of the summation.

The energy conservation equation for each segment is

$$\frac{du_{seg, 2P} M_{2P}}{dt} + u_{seg, 2P}(\dot{m}_{seg, in, 2P} - \dot{m}_{seg, out, 2P}) = \Phi_{seg, in, 2P} - \Phi_{seg, out, 2P} + Q_{seg, 2P},$$

where:

- M_{2P} is the total two-phase fluid mass.
- $\dot{m}_{seg, in, 2P}$ and $\dot{m}_{seg, out, 2P}$ are the mass flow rates into and out of the segment.
- $\Phi_{seg, in, 2P}$ and $\Phi_{seg, out, 2P}$ are the energy flow rates into and out of the segment.

The mass flow rates between segments are assumed to be linearly distributed between the values of $\dot{m}_{A, 2P}$ and $\dot{m}_{B, 2P}$.

Moist Air Mass and Energy Conservation

The mass conservation for the overall moist air mixture flow is

$$\left(\frac{dp_{MA}}{dt} \sum_{segments} \left(\frac{\partial \rho_{seg, MA}}{\partial p} \right) + \sum_{segments} \left(\frac{dT_{seg, MA}}{dt} \frac{\partial \rho_{seg, MA}}{\partial T} + \frac{dx_{w, seg, MA}}{dt} \frac{\partial \rho_{seg, MA}}{\partial x_w} + \frac{dx_{g, seg, MA}}{dt} \frac{\partial \rho_{seg, MA}}{\partial x_g} \right) \right) \frac{V_{MA}}{N} = \dot{m}_{A, MA} + \dot{m}_{B, MA} - \sum_{segments} (\dot{m}_{w, seg, cond}),$$

where:

- $\frac{\partial \rho_{seg, MA}}{\partial p}$ is the partial derivative of density with respect to pressure for the segment.
- $\frac{\partial \rho_{seg, MA}}{\partial T}$ is the partial derivative of density with respect to temperature for the segment.
- $\frac{\partial \rho_{seg, MA}}{\partial x_w}$ is the partial derivative of density with respect to specific humidity for the segment.
- $\frac{\partial \rho_{seg, MA}}{\partial x_g}$ is the partial derivative of density with respect to trace gas mass fraction for the segment.
- $x_{w, seg, MA}$ is the specific humidity, that is, the water vapor mass fraction, for the segment.
- $x_{g, seg, MA}$ is the trace gas mass fraction for the segment.
- V_{MA} is the total moist air volume.

The summation is over all segments.

Note Although the two-phase fluid flow is divided into $N=3$ segments for heat transfer calculations, all segments are assumed to be at the same internal pressure, p_{MA} . That is why p_{MA} is outside of the summation.

The energy conservation equation for each segment is

$$\left(\frac{dT_{seg, MA}}{dt} \frac{\partial u_{seg, MA}}{\partial T} + \frac{dx_{w, seg, MA}}{dt} \frac{\partial u_{seg, MA}}{\partial x_w} + \frac{dx_{g, seg, MA}}{dt} \frac{\partial u_{seg, MA}}{\partial x_g} \right) \frac{M_{MA}}{N} + u_{seg, MA}(\dot{m}_{seg, in, MA} - \dot{m}_{seg, out, MA}) - \Phi_{seg, in, MA} + \Phi_{seg, out, MA} + Q_{seg, MA} - \dot{m}_{w, seg, cond} h_{l, wall},$$

where:

- $\frac{\partial u_{seg,MA}}{\partial T}$ is the partial derivative of specific internal energy with respect to temperature for the segment.
- $\frac{\partial u_{seg,MA}}{\partial x_w}$ is the partial derivative of specific internal energy with respect to specific humidity for the segment.
- $\frac{\partial u_{seg,MA}}{\partial x_g}$ is the partial derivative of specific internal energy with respect to trace gas mass fraction for the segment.
- $u_{seg,2P}$ is the specific internal energy for the segment.
- M_{MA} is the total moist air mass.
- $\dot{m}_{seg,in,MA}$ and $\dot{m}_{seg,out,MA}$ are the mass flow rates into and out of the segment.
- $\Phi_{seg,in,MA}$ and $\Phi_{seg,out,MA}$ are the energy flow rates into and out of the segment.

The mass flow rates between segments are assumed to be linearly distributed between the values of $\dot{m}_{A,MA}$ and $\dot{m}_{B,MA}$.

The water vapor mass conservation equation for each segment is

$$\frac{dx_{w,seg,MA}}{dt} \frac{M_{MA}}{N} + x_{w,seg,MA}(\dot{m}_{seg,in,MA} - \dot{m}_{seg,out,MA}) = \dot{m}_{w,seg,in,MA} - \dot{m}_{w,seg,out,MA} - \dot{m}_{w,seg,cond}$$

where $\dot{m}_{w,seg,in,MA}$ and $\dot{m}_{w,seg,out,MA}$ are the water vapor mass flow rates into and out of the segment.

The trace gas mass conservation equation for each segment is

$$\frac{dx_{g,seg,MA}}{dt} \frac{M_{MA}}{N} + x_{g,seg,MA}(\dot{m}_{seg,in,MA} - \dot{m}_{seg,out,MA}) = \dot{m}_{g,seg,in,MA} - \dot{m}_{g,seg,out,MA}$$

where $\dot{m}_{g,seg,in,MA}$ and $\dot{m}_{g,seg,out,MA}$ are the trace gas mass flow rates into and out of the segment.

Ports

Output

Q1 — Rate of heat transfer to two-phase fluid, W

physical signal

Rate of heat transfer to two-phase fluid, returned as a physical signal. Physical signals **Q1** and **Q2** are usually equal in value with opposite sign. However, if the **Wall thermal mass** parameter is set to 0n, then these two signals may have different values because the wall may absorb and release some of the heat being transferred.

Q2 — Rate of heat transfer to moist air, W

physical signal

Rate of heat transfer to moist air, returned as a physical signal. Physical signals **Q1** and **Q2** are usually equal in value with opposite sign. However, if the **Wall thermal mass** parameter is set to **On**, then these two signals may have different values because the wall may absorb and release some of the heat being transferred.

W — Moist air condensation rate, kg/s

physical signal

Water condensation rate in the moist air flow, returned as a physical signal. The condensate does not accumulate on the heat transfer surface.

Conserving

A1 — Two-phase fluid port

two-phase fluid

Inlet or outlet port associated with the two-phase fluid.

B1 — Two-phase fluid port

two-phase fluid

Inlet or outlet port associated with the two-phase fluid.

A2 — Moist air port

moist air

Inlet or outlet port associated with the moist air.

B2 — Moist air port

moist air

Inlet or outlet port associated with the moist air.

Parameters

Configuration

Wall thermal mass — Enable or disable effect of thermal mass on heat transfer surface

Off (default) | On

Enable or disable the effect of thermal mass on the heat transfer surface. Setting this parameter to **On** introduces additional dynamics to the simulation, so that it takes longer to reach steady state, but does not affect the results at steady-state simulation.

Wall mass — Mass of heat transfer surface

1 kg (default) | positive scalar

Mass of the heat transfer surface.

Dependencies

To enable this parameter, set **Wall thermal mass** to **On**.

Wall specific heat — Specific heat of heat transfer surface

490 J/(K*kg) (default) | positive scalar

Specific heat of the heat transfer surface.

Dependencies

To enable this parameter, set **Wall thermal mass** to 0n.

Cross-sectional area at port A1 — Flow area at port A1

0.01 m² (default) | positive scalar

Flow area at the two-phase fluid port **A1**.

Cross-sectional area at port B1 — Flow area at port B1

0.01 m² (default) | positive scalar

Flow area at the two-phase fluid port **B1**.

Cross-sectional area at port A2 — Flow area at port A2

0.01 m² (default) | positive scalar

Flow area at the moist air port **A2**.

Cross-sectional area at port B2 — Area normal to flow at port B2

0.01 m² (default) | positive scalar

Flow area at the moist air port **B2**.

Two-Phase Fluid 1**Nominal operating condition — Select whether nominal operating condition corresponds to condenser or evaporator**

Condenser - heat transfer from two-phase fluid to moist air (default) | Evaporator
- heat transfer from moist air to two-phase fluid

Select the nominal operating condition:

- Condenser - heat transfer from two-phase fluid to moist air — The two-phase fluid is being cooled and the moist air is being heated.
- Evaporator - heat transfer from moist air to two-phase fluid — The moist air is being cooled and the two-phase fluid is being heated.

This choice relates only to specifying the nominal operating condition parameters. It does not mean that heat transfer can only happen in the specified direction during simulation.

Nominal mass flow rate — Mass flow rate between two-phase ports during nominal operating condition

0.001 kg/s (default) | positive scalar

Mass flow rate from port **A1** to port **B1** during the nominal operating condition.

Nominal pressure drop — Pressure drop between two-phase ports during nominal operating condition

0.001 MPa (default) | positive scalar

Pressure drop from port **A1** to port **B1** during the nominal operating condition.

Pressure specification — Select method of pressure specification

Inlet pressure (default) | Saturation pressure at specified condensing temperature
| Saturation pressure at specified evaporating temperature

Select the method of pressure specification:

- Inlet pressure — Specify the nominal inlet pressure.
- Saturation pressure at specified condensing temperature — Specify the nominal condensing temperature. This option is available if you set **Nominal operating condition** to Condenser - heat transfer from two-phase fluid to moist air.
- Saturation pressure at specified evaporating temperature — Specify the nominal evaporating temperature. This option is available if you set **Nominal operating condition** to Evaporator - heat transfer from moist air to two-phase fluid.

Nominal inlet pressure — Pressure at the two-phase fluid side inlet

1 MPa (default) | positive scalar

Pressure at the inlet of the two-phase fluid side of the heat exchanger during nominal operating condition.

Dependencies

To enable this parameter, set **Pressure specification** to Inlet pressure.

Nominal condensing temperature — Use nominal condensing temperature to specify pressure

313.15 K (default) | positive scalar

Liquid saturation temperature at the outlet of the two-phase fluid side of the heat exchanger during nominal operating condition. The pressure in the heat exchanger is the corresponding saturation pressure. The nominal condensing temperature must be less than the critical temperature.

Dependencies

To enable this parameter, set **Nominal operating condition** to Condenser - heat transfer from two-phase fluid to moist air and **Pressure specification** to Saturation pressure at specified condensing temperature.

Nominal evaporating temperature — Use nominal evaporating temperature to specify pressure

243.15 K (default) | positive scalar

Vapor saturation temperature at the outlet of the two-phase fluid side of the heat exchanger during nominal operating condition. The pressure in the heat exchanger is the corresponding saturation pressure. The nominal evaporating temperature must be less than the critical temperature.

Dependencies

To enable this parameter, set **Nominal operating condition** to Evaporator - heat transfer from moist air to two-phase fluid and **Pressure specification** to Saturation pressure at specified evaporating temperature.

Inlet condition specification — Select quantity to describe the inlet condition of the two-phase fluid

Specific enthalpy (default) | Temperature | Vapor quality

Quantity used to describe the inlet condition of the fluid at the nominal operating condition: temperature, specific enthalpy, or vapor quality.

Nominal inlet specific enthalpy — Specific enthalpy at the two-phase fluid side inlet

440 kJ/kg (default) | positive scalar

Specific enthalpy at the inlet of the two-phase fluid side of the heat exchanger during the nominal operating condition.

Dependencies

To enable this parameter, set **Inlet condition specification** to Specific enthalpy.

Nominal inlet temperature — Temperature at the two-phase fluid side inlet

313.15 K (default) | positive scalar

Temperature at the inlet of the two-phase fluid side of the heat exchanger during the nominal operating condition.

Dependencies

To enable this parameter, set **Inlet condition specification** to Temperature.

Nominal inlet vapor quality — Vapor quality at the two-phase fluid side inlet

1 (default) | positive scalar

Vapor quality, defined as the mass fraction of vapor in a liquid-vapor mixture, at the inlet of the two-phase fluid side of the heat exchanger during the nominal operating condition.

Dependencies

To enable this parameter, set **Inlet condition specification** to Vapor quality.

Heat transfer capacity specification — Select how to specify heat transfer capacity of the two-phase fluid

Rate of heat transfer (default) | Outlet condition

Select whether to specify the performance of the heat exchanger at the nominal operating condition directly, by the rate of heat transfer, or indirectly, by the outlet condition.

Nominal rate of heat transfer — Specify performance by rate of heat transfer

0.1 kW (default) | positive scalar

Rate of heat transfer, depending on the nominal operating condition:

- If **Nominal operating condition** is Condenser - heat transfer from two-phase fluid to moist air, rate of heat transfer from the two-phase fluid to the moist air during the nominal operating condition.
- If **Nominal operating condition** is Evaporator - heat transfer from moist air to two-phase fluid, rate of heat transfer from the moist air to the two-phase fluid during the nominal operating condition.

Dependencies

To enable this parameter, set **Heat transfer capacity specification** to Rate of heat transfer.

Outlet condition specification — Select quantity for outlet condition specification

Specific enthalpy (default) | Subcooling | Superheating | Vapor quality

Select the quantity for outlet condition specification:

- Specific enthalpy — Specify the nominal specific enthalpy.
- Subcooling — Specify the nominal subcooling. This option is available if you set **Nominal operating condition** to Condenser - heat transfer from two-phase fluid to moist air.
- Superheating — Specify the nominal superheating. This option is available if you set **Nominal operating condition** to Evaporator - heat transfer from moist air to two-phase fluid.
- Vapor quality — Specify the nominal vapor quality.

Dependencies

To enable this parameter, set **Heat transfer capacity specification** to Outlet condition.

Nominal outlet specific enthalpy — Specific enthalpy at the two-phase fluid side outlet

250 kJ/kg (default) | positive scalar | two-element vector

Specific enthalpy at the outlet of the two-phase fluid side of the heat exchanger during the nominal operating condition.

Dependencies

To enable this parameter, set **Outlet condition specification** to Specific enthalpy.

Nominal subcooling — Degree of temperature below the liquid saturation temperature at the two-phase fluid side outlet

5 deltaK (default) | positive scalar

Degree of temperature below the liquid saturation temperature at the outlet of the two-phase fluid side of the heat exchanger during the nominal operating condition.

Dependencies

To enable this parameter, set **Outlet condition specification** to Subcooling.

Nominal superheating — Degree of temperature above the vapor saturation temperature at the two-phase fluid side outlet

5 deltaK (default) | positive scalar

Degree of temperature above the vapor saturation temperature at the outlet of the two-phase fluid side of the heat exchanger during the nominal operating condition.

Dependencies

To enable this parameter, set **Outlet condition specification** to Superheating.

Nominal outlet vapor quality — Vapor mass fraction at the two-phase fluid side outlet

0 (default) | scalar in the range [0,1]

Two-phase fluid vapor quality, defined as the mass fraction of vapor in a liquid-vapor mixture, at the outlet of the two-phase fluid side of the heat exchanger during the nominal operating condition.

Dependencies

To enable this parameter, set **Outlet condition specification** to Vapor quality.

Two-phase fluid volume — Total volume of two-phase fluid

0.001 m³ (default) | positive scalar

Total volume of two-phase fluid inside the heat exchanger.

Initial condition specification — Select how to specify initial state of two-phase fluid

Same as nominal operating condition (default) | Specify initial condition

Select how to specify initial state of two-phase fluid:

- Same as nominal operating condition — Start the simulation at the nominal operating condition.
- Specify initial condition — Specify a different set of initial conditions using additional parameters.

Initial fluid energy specification — Initial state of the two-phase fluid

Specific enthalpy (default) | Temperature | Vapor quality | Vapor void fraction | Specific internal energy

Quantity used to describe the initial state of the fluid: temperature, vapor quality, vapor void fraction, specific enthalpy, or specific internal energy.

Dependencies

To enable this parameter, set **Initial condition specification** to Specify initial condition.

Initial two-phase fluid pressure — Fluid pressure at start of simulation

0.101325 MPa (default) | positive scalar

Two-phase fluid pressure at the start of the simulation.

Initial two-phase fluid specific enthalpy — Enthalpy per unit mass at start of simulation

1500 kJ/kg (default) | positive scalar | two-element vector

Two-phase fluid specific enthalpy at the start of simulation. If the value is a scalar, then the initial specific enthalpy is assumed uniform. If the value is a two-element vector, then the initial specific enthalpy is assumed to vary linearly between ports **A1** and **B1**, with the first element corresponding to port **A1** and the second element corresponding to port **B1**.

Dependencies

To enable this parameter, set **Initial fluid energy specification** to Specific enthalpy.

Initial two-phase fluid temperature — Temperature at start of simulation

293.15 K (default) | positive scalar | two-element vector

Two-phase fluid temperature at the start of simulation. If the value is a scalar, then the initial temperature is assumed uniform. If the value is a two-element vector, then the initial temperature is assumed to vary linearly between ports **A1** and **B1**, with the first element corresponding to port **A1** and the second element corresponding to port **B1**.

Dependencies

To enable this parameter, set **Initial fluid energy specification** to Temperature.

Initial two-phase fluid vapor quality — Vapor mass fraction at start of simulation

0.5 (default) | scalar in the range [0,1] | two-element vector

Two-phase fluid vapor quality, defined as the mass fraction of vapor in a liquid-vapor mixture, at the start of simulation. If the value is a scalar, then the initial vapor quality is assumed uniform. If the value is a two-element vector, then the initial vapor quality is assumed to vary linearly between ports **A1** and **B1**, with the first element corresponding to port **A1** and the second element corresponding to port **B1**.

If using this option, the initial pressure cannot be higher than the critical pressure.

Dependencies

To enable this parameter, set **Initial fluid energy specification** to Vapor quality.

Initial two-phase fluid vapor void fraction — Vapor volume fraction at start of simulation

0.5 (default) | scalar in the range [0,1] | two-element vector

Two-phase fluid vapor void fraction, defined as the volume fraction of vapor in a liquid-vapor mixture, at the start of simulation. If the value is a scalar, then the initial vapor void fraction is assumed uniform. If the value is a two-element vector, then the initial vapor void fraction is assumed to vary linearly between ports **A1** and **B1**, with the first element corresponding to port **A1** and the second element corresponding to port **B1**.

If using this option, the initial pressure cannot be higher than the critical pressure.

Dependencies

To enable this parameter, set **Initial fluid energy specification** to Vapor void fraction.

Initial two-phase fluid specific internal energy — Internal energy per unit mass at start of simulation

1500 kJ/kg (default) | positive scalar | two-element vector

Two-phase fluid specific internal energy at the start of simulation. If the value is a scalar, then the initial specific internal energy is assumed uniform. If the value is a two-element vector, then the initial specific internal energy is assumed to vary linearly between ports **A1** and **B1**, with the first element corresponding to port **A1** and the second element corresponding to port **B1**.

Dependencies

To enable this parameter, set **Initial fluid energy specification** to Specific internal energy.

Moist Air 2**Nominal mass flow rate — Mass flow rate between moist air ports during nominal operating condition**

0.1 kg/s (default) | positive scalar

Mass flow rate from port **A2** to port **B2** during the nominal operating condition.

Nominal pressure drop — Pressure drop between moist air ports during nominal operating condition

0.001 MPa (default) | positive scalar

Pressure drop from port **A2** to port **B2** during the nominal operating condition.

Nominal inlet pressure — Pressure at the moist air side inlet

0.101325 MPa (default) | positive scalar

Pressure at the inlet of the moist air side of the heat exchanger during nominal operating condition.

Nominal inlet temperature — Temperature at the moist air side inlet

293.15 K (default) | positive scalar

Temperature at the inlet of the moist air side of the heat exchanger during the nominal operating condition.

Inlet moisture specification — Quantity used to describe the moisture level at the moist air side inlet

Relative humidity (default) | Specific humidity | Mole fraction | Humidity ratio

Select quantity used to describe the moisture level at the inlet during the nominal operating condition: relative humidity, specific humidity, water vapor mole fraction, or humidity ratio.

Nominal inlet relative humidity — Relative humidity at the inlet

0.5 (default) | scalar in the range [0,1]

Relative humidity at the inlet of the moist air side of the heat exchanger during the nominal operating condition.

Dependencies

To enable this parameter, set **Inlet moisture specification** to Relative humidity.

Nominal inlet specific humidity — Specific humidity at the inlet

0.01 (default) | scalar in the range [0,1]

Specific humidity, defined as the mass fraction of water vapor in a moist air mixture, at the inlet of the moist air side of the heat exchanger during the nominal operating condition.

Dependencies

To enable this parameter, set **Inlet moisture specification** to Specific humidity.

Nominal inlet water vapor mole fraction — Mole fraction of water vapor at the inlet

0.01 (default) | scalar in the range [0,1]

Mole fraction of water vapor in a moist air mixture at the inlet of the moist air side of the heat exchanger during the nominal operating condition.

Dependencies

To enable this parameter, set **Inlet moisture specification** to Mole fraction.

Nominal inlet humidity ratio — Humidity ratio at the inlet

0.01 (default) | positive scalar in the range [0,1]

Humidity ratio, defined as the mass ratio of water vapor to dry air and trace gas, at the inlet of the moist air side of the heat exchanger during the nominal operating condition.

Dependencies

To enable this parameter, set **Inlet moisture specification** to Humidity ratio.

Inlet trace gas specification – Quantity used to describe trace gas level at the inlet

Mass fraction (default) | Mole fraction

Select quantity used to describe the trace gas level at the inlet during the nominal operating condition: mass fraction or mole fraction.

Nominal inlet trace gas mass fraction – Mass fraction of trace gas at the inlet

0.001 (default) | scalar in the range [0,1]

Mass fraction of trace gas in a moist air mixture at the inlet of the moist air side of the heat exchanger during the nominal operating condition.

This parameter is ignored if the **Trace gas model** parameter in the Moist Air Properties (MA) block is set to None.

Dependencies

To enable this parameter, set **Inlet trace gas specification** to Mass fraction.

Nominal inlet trace gas mole fraction – Mole fraction of trace gas at the inlet

0.001 (default) | scalar in the range [0,1]

Mole fraction of trace gas in a moist air mixture at the inlet of the moist air side of the heat exchanger during the nominal operating condition.

This parameter is ignored if the **Trace gas model** parameter in the Moist Air Properties (MA) block is set to None.

Dependencies

To enable this parameter, set **Inlet trace gas specification** to Mole fraction.

Moist air volume – Total volume of moist air in the heat exchanger

0.001 m³ (default) | positive scalar

Total volume of moist air in the heat exchanger.

Initial condition specification – Select how to specify initial state of moist air

Same as nominal operating condition (default) | Specify initial condition

Select how to specify initial state of moist air:

- Same as nominal operating condition – Start the simulation at the nominal operating condition.
- Specify initial condition – Specify a different set of initial conditions using additional parameters.

Initial moist air pressure – Moist air pressure at start of simulation

0.101325 MPa (default) | positive scalar

Moist air pressure at the start of the simulation.

Initial moist air temperature — Moist air temperature at start of simulation

293.15 K (default) | positive scalar | two-element vector

Moist air temperature at the start of simulation. If the value is a scalar, then the initial temperature is assumed uniform. If the value is a two-element vector, then the initial temperature is assumed to vary linearly between ports **A2** and **B2**, with the first element corresponding to port **A2** and the second element corresponding to port **B2**.

Initial moisture specification — Quantity used to describe the initial moisture level

Relative humidity (default) | Specific humidity | Mole fraction | Humidity ratio

Select quantity used to describe the initial moisture level: relative humidity, specific humidity, water vapor mole fraction, or humidity ratio.

Initial moist air relative humidity — Relative humidity at the start of simulation

0.5 (default) | scalar in the range [0,1] | two-element vector

Moist air relative humidity at the start of simulation. If the value is a scalar, then the initial relative humidity is assumed uniform. If the value is a two-element vector, then the initial relative humidity is assumed to vary linearly between ports **A2** and **B2**, with the first element corresponding to port **A2** and the second element corresponding to port **B2**.

Dependencies

To enable this parameter, set **Initial moisture specification** to Relative humidity.

Initial moist air specific humidity — Specific humidity at the start of simulation

0.01 (default) | scalar in the range [0,1] | two-element vector

Moist air specific humidity, defined as the mass fraction of water vapor in a moist air mixture, at the start of simulation. If the value is a scalar, then the initial specific humidity is assumed uniform. If the value is a two-element vector, then the initial specific humidity is assumed to vary linearly between ports **A2** and **B2**, with the first element corresponding to port **A2** and the second element corresponding to port **B2**.

Dependencies

To enable this parameter, set **Initial moisture specification** to Specific humidity.

Initial moist air water vapor mole fraction — Mole fraction of water vapor at the start of simulation

0.01 (default) | scalar in the range [0,1] | two-element vector

Mole fraction of water vapor in a moist air mixture at the start of simulation. If the value is a scalar, then the initial mole fraction is assumed uniform. If the value is a two-element vector, then the initial mole fraction is assumed to vary linearly between ports **A2** and **B2**, with the first element corresponding to port **A2** and the second element corresponding to port **B2**.

Dependencies

To enable this parameter, set **Initial moisture specification** to Mole fraction.

Initial moist air humidity ratio — Humidity ratio at the start of simulation

0.01 (default) | positive scalar in the range [0,1] | two-element vector

Moist air humidity ratio, defined as the mass ratio of water vapor to dry air and trace gas, at the start of simulation. If the value is a scalar, then the initial humidity ratio is assumed uniform. If the value is a two-element vector, then the initial humidity ratio is assumed to vary linearly between ports **A2** and **B2**, with the first element corresponding to port **A2** and the second element corresponding to port **B2**.

Dependencies

To enable this parameter, set **Initial moisture specification** to Humidity ratio.

Initial trace gas specification – Quantity used to describe initial trace gas level

Mass fraction (default) | Mole fraction

Select quantity used to describe the trace gas level at the start of simulation: mass fraction or mole fraction.

Initial moist air trace gas mass fraction – Mass fraction of trace gas at the start of simulation

0.001 (default) | scalar in the range [0,1] | two-element vector

Mass fraction of trace gas in a moist air mixture at the start of simulation. If the value is a scalar, then the initial mass fraction is assumed uniform. If the value is a two-element vector, then the initial mass fraction is assumed to vary linearly between ports **A2** and **B2**, with the first element corresponding to port **A2** and the second element corresponding to port **B2**.

This parameter is ignored if the **Trace gas model** parameter in the Moist Air Properties (MA) block is set to None.

Dependencies

To enable this parameter, set **Initial trace gas specification** to Mass fraction.

Initial moist air trace gas mole fraction – Mole fraction of trace gas at the start of simulation

0.001 (default) | scalar in the range [0,1] | two-element vector

Mole fraction of trace gas in a moist air mixture at the start of simulation. If the value is a scalar, then the initial mole fraction is assumed uniform. If the value is a two-element vector, then the initial mole fraction is assumed to vary linearly between ports **A2** and **B2**, with the first element corresponding to port **A2** and the second element corresponding to port **B2**.

This parameter is ignored if the **Trace gas model** parameter in the Moist Air Properties (MA) block is set to None.

Dependencies

To enable this parameter, set **Initial trace gas specification** to Mole fraction.

Relative humidity at saturation – Relative humidity point of condensation

1 (default) | nonnegative scalar

Relative humidity point of condensation. Condensation occurs above this value. In most cases, this value is 1, that is, 100%. A value greater than 1 indicates a supersaturated vapor.

Correlation Coefficients

a in $Nu = a \cdot Re^b \cdot Pr^c$ for two-phase fluid liquid – Correlation coefficient for subcooled liquid in two-phase fluid

0.023 (default) | positive scalar

Proportionality constant in the correlation of Nusselt number as a function of Reynolds number and Prandtl number for subcooled liquid in two-phase fluid. The default value is based on the Colburn equation.

a in $Nu = a \cdot Re^b \cdot Pr^c$ for two-phase fluid mixture – Correlation coefficient for liquid-vapor mixture in two-phase fluid

0.005 (default) | positive scalar

Proportionality constant in the correlation of Nusselt number as a function of Reynolds number and Prandtl number for liquid-vapor mixture in two-phase fluid. The default value is based on the Cavallini and Zecchin correlation.

a in $Nu = a \cdot Re^b \cdot Pr^c$ for two-phase fluid vapor – Correlation coefficient for superheated vapor in two-phase fluid

0.023 (default) | positive scalar

Proportionality constant in the correlation of Nusselt number as a function of Reynolds number and Prandtl number for superheated vapor in two-phase fluid. The default value is based on the Colburn equation.

b in $Nu = a \cdot Re^b \cdot Pr^c$ for two-phase fluid – Reynolds number exponent in correlation for two-phase fluid

0.8 (default) | positive scalar

Reynolds number exponent in the correlation of Nusselt number as a function of Reynolds number and Prandtl number for two-phase fluid. The same value applies to subcooled liquid, liquid-vapor mixture, and superheated vapor.

c in $Nu = a \cdot Re^b \cdot Pr^c$ for two-phase fluid – Prandtl number exponent in correlation for two-phase fluid

0.33 (default) | positive scalar

Prandtl number exponent in the correlation of Nusselt number as a function of Reynolds number and Prandtl number for two-phase fluid. The same value applies to subcooled liquid, liquid-vapor mixture, and superheated vapor.

a in $Nu = a \cdot Re^b \cdot Pr^c$ for moist air – Correlation coefficient for moist air

0.005 (default) | positive scalar

Proportionality constant in the correlation of Nusselt number as a function of Reynolds number and Prandtl number for moist air. The default value is based on the Colburn equation.

b in $Nu = a \cdot Re^b \cdot Pr^c$ for moist air – Reynolds number exponent in correlation for moist air

0.8 (default) | positive scalar

Reynolds number exponent in the correlation of Nusselt number as a function of Reynolds number and Prandtl number for moist air. The default value is based on the Colburn equation.

c in $Nu = a \cdot Re^b \cdot Pr^c$ for moist air – Prandtl number exponent in correlation for moist air

0.33 (default) | positive scalar

Prandtl number exponent in the correlation of Nusselt number as a function of Reynolds number and Prandtl number for moist air. The default value is based on the Colburn equation.

References

- [1] *Ashrae Handbook: Fundamentals*. Atlanta: Ashrae, 2013.
- [2] Çengel, Yunus A. *Heat and Mass Transfer: A Practical Approach*. 3rd ed. McGraw-Hill Series in Mechanical Engineering. Boston: McGraw-Hill, 2007.
- [3] Mitchell, John W., and James E. Braun. *Principles of Heating, Ventilation, and Air Conditioning in Buildings*. Hoboken, NJ: Wiley, 2013.
- [4] Shah, R. K., and Dušan P. Sekulić. *Fundamentals of Heat Exchanger Design*. Hoboken, NJ: John Wiley & Sons, 2003.
- [5] Cavallini, Alberto, and Roberto Zecchin. "A DIMENSIONLESS CORRELATION FOR HEAT TRANSFER IN FORCED CONVECTION CONDENSATION." In *Proceeding of International Heat Transfer Conference 5*, 309-13. Tokyo, Japan: Begellhouse, 1974. <https://doi.org/10.1615/IHTC5.1220>.

Extended Capabilities**C/C++ Code Generation**

Generate C and C++ code using Simulink® Coder™.

See Also

Condenser Evaporator (2P-MA) | System-Level Heat Exchanger (2P-2P)

Introduced in R2021b

System-Level Heat Exchanger (2P-2P)

Heat exchanger between two two-phase fluid networks, with model based on performance data

Library: Simscape / Fluids / Fluid Network Interfaces / Heat Exchangers

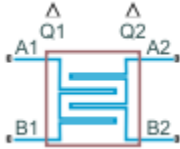

Description

The System-Level Heat Exchanger (2P-2P) block models a heat exchanger between two distinct two-phase fluid networks. Each network has its own set of fluid properties.

The block model is based on performance data from the heat exchanger datasheet, rather than on the detailed geometry of the exchanger, and therefore you can use this block when geometry data is unavailable. Either or both sides of the heat exchanger can condense or vaporize fluid as a result of the heat exchange. You can also use this block as an internal heat exchanger in a refrigeration system. An internal heat exchanger improves refrigeration system efficiency by providing additional heat exchange between the outlet of the condenser and the outlet of the evaporator.

You parameterize the block by the nominal operating condition. The heat exchanger is sized to match the specified performance at the nominal operating condition at steady state.

Each side of the heat exchanger approximates the liquid zone, mixture zone, and vapor zone based on the change in enthalpy along the flow path.

Heat Transfer

The two-phase fluid 1 flow and the two-phase fluid 2 flow are each divided into three segments of equal size. Heat transfer between the fluids is calculated in each segment. For simplicity, the equation for one segment is shown here.

If the wall thermal mass is off, then the heat balance in the heat exchanger is

$$Q_{seg,2P1} + Q_{seg,2P2} = 0,$$

where:

- $Q_{seg,2P1}$ is the heat flow rate from the wall (that is, the heat transfer surface) to the two-phase fluid 1 in the segment.
- $Q_{seg,2P2}$ is the heat flow rate from the wall to the two-phase fluid 2 in the segment.

If the wall thermal mass is on, then the heat balance in the heat exchanger is

$$Q_{seg,2P1} + Q_{seg,2P2} = - \frac{M_{wall} c_{pwall}}{N} \frac{dT_{seg,wall}}{dt},$$

where:

- M_{wall} is the mass of the wall.
- c_{pwall} is the specific heat of the wall.
- $N = 3$ is the number of segments.
- $T_{\text{seg,wall}}$ is the average wall temperature in the segment.
- t is time.

The heat flow rate from the wall to the two-phase fluid 1 in the segment is

$$Q_{\text{seg}, 2P1} = UA_{\text{seg}, 2P1}(T_{\text{seg}, \text{wall}} - T_{\text{seg}, 2P1}),$$

where:

- $UA_{\text{seg}, 2P1}$ is the weighted-average heat transfer conductance for the two-phase fluid 1 in the segment.
- $T_{\text{seg}, 2P1}$ is the weighted-average fluid temperature for the two-phase fluid 1 in the segment.

The heat flow rate from the wall to the two-phase fluid 2 in the segment is

$$Q_{\text{seg}, 2P2} = UA_{\text{seg}, 2P2}(T_{\text{seg}, \text{wall}} - T_{\text{seg}, 2P2}),$$

where:

- $UA_{\text{seg}, 2P2}$ is the weighted-average heat transfer conductance for the two-phase fluid 2 in the segment.
- $T_{\text{seg}, 2P2}$ is the weighted-average fluid temperature for the two-phase fluid 2 in the segment.

Two-Phase Fluid 1 Heat Transfer Correlation

If the segment is subcooled liquid, then the heat transfer conductance is

$$UA_{\text{seg}, L, 2P1} = a_{L, 2P1}(\text{Re}_{\text{seg}, L, 2P1})^{b_{2P1}}(\text{Pr}_{\text{seg}, L, 2P1})^{c_{2P1}}k_{\text{seg}, L, 2P1}\frac{G_{2P1}}{N},$$

where:

- $a_{L, 2P1}$, b_{2P1} , and c_{2P1} are the coefficients of the Nusselt number correlation. These coefficients appear as block parameters in the **Correlation Coefficients** section.
- $\text{Re}_{\text{seg}, L, 2P1}$ is the average liquid Reynolds number for the segment.
- $\text{Pr}_{\text{seg}, L, 2P1}$ is the average liquid Prandtl number for the segment.
- $k_{\text{seg}, L, 2P1}$ is the average liquid thermal conductivity for the segment.
- G_{2P1} is the geometry scale factor for the two-phase fluid 1 side of the heat exchanger. The block calculates the geometry scale factor so that the total heat transfer over all segments matches the specified performance at the nominal operating conditions.

The average liquid Reynolds number is

$$\text{Re}_{\text{seg}, L, 2P1} = \frac{\dot{m}_{\text{seg}, 2P1}D_{\text{ref}, 2P1}}{\mu_{\text{seg}, L, 2P1}S_{\text{ref}, 2P1}},$$

where:

- $\dot{m}_{seg, 2P1}$ is the mass flow rate through the segment.
- $\mu_{seg,L,2P1}$ is the average liquid dynamic viscosity for the segment.
- $D_{ref,2P1}$ is an arbitrary reference diameter.
- $S_{ref,2P1}$ is an arbitrary reference flow area.

Note The $D_{ref,2P1}$ and $S_{ref,2P1}$ terms are included in this equation for unit calculation purposes only, to make $Re_{seg,L,2P1}$ nondimensional. The values of $D_{ref,2P1}$ and $S_{ref,2P1}$ are arbitrary because the G_{2P1} calculation overrides these values.

Similarly, if the segment is superheated vapor, then the heat transfer conductance is

$$UA_{seg, V, 2P1} = a_{V, 2P1} (Re_{seg, V, 2P1})^{b_{2P1}} (Pr_{seg, V, 2P1})^{c_{2P1}} k_{seg, V, 2P1} \frac{G_{2P1}}{N},$$

where:

- $a_{V,2P1}$, b_{2P1} , and c_{2P1} are the coefficients of the Nusselt number correlation. These coefficients appear as block parameters in the **Correlation Coefficients** section.
- $Re_{seg,V,2P1}$ is the average vapor Reynolds number for the segment.
- $Pr_{seg,V,2P1}$ is the average vapor Prandtl number for the segment.
- $k_{seg,V,2P1}$ is the average vapor thermal conductivity for the segment.

The average vapor Reynolds number is

$$Re_{seg, V, 2P1} = \frac{\dot{m}_{seg, 2P1} D_{ref, 2P1}}{\mu_{seg, V, 2P1} S_{ref, 2P1}},$$

where $\mu_{seg,V,2P1}$ is the average vapor dynamic viscosity for the segment.

If the segment is liquid-vapor mixture, then the heat transfer conductance is

$$UA_{seg, M, 2P1} = a_{M, 2P1} (Re_{seg, SL, 2P1})^{b_{2P1}} CZ (Pr_{seg, SL, 2P1})^{c_{2P1}} k_{seg, SL, 2P1} \frac{G_{2P1}}{N},$$

where:

- $a_{M,2P1}$, b_{2P1} , and c_{2P1} are the coefficients of the Nusselt number correlation. These coefficients appear as block parameters in the **Correlation Coefficients** section.
- $Re_{seg,SL,2P1}$ is the saturated liquid Reynolds number for the segment.
- $Pr_{seg,SL,2P1}$ is the saturated liquid Prandtl number for the segment.
- $k_{seg,SL,2P1}$ is the saturated liquid thermal conductivity for the segment.
- CZ is the Cavallini and Zecchin term.

The saturated liquid Reynolds number is

$$Re_{seg, SL, 2P1} = \frac{\dot{m}_{seg, 2P1} D_{ref, 2P1}}{\mu_{seg, SL, 2P1} S_{ref, 2P1}},$$

where $\mu_{seg,SL,2P1}$ is the saturated liquid dynamic viscosity for the segment.

The Cavallini and Zecchin term is

$$CZ = \frac{\left(\left(\sqrt{\frac{\nu_{seg,SV,2P1}}{\nu_{seg,SL,2P1}}} - 1 \right) (x_{seg,out,2P1} + 1) \right)^{1+b_{2P1}} - \left(\left(\sqrt{\frac{\nu_{seg,SV,2P1}}{\nu_{seg,SL,2P1}}} - 1 \right) (x_{seg,in,2P1} + 1) \right)^{1+b_{2P1}}}{(1+b_{2P1}) \left(\sqrt{\frac{\nu_{seg,SV,2P1}}{\nu_{seg,SL,2P1}}} - 1 \right) (x_{seg,out,2P1} - x_{seg,in,2P1})},$$

where:

- $\nu_{seg,SL,2P1}$ is the saturated liquid specific volume for the segment.
- $\nu_{seg,SV,2P1}$ is the saturated vapor specific volume for the segment.
- $x_{seg,in,2P1}$ is the vapor quality at the segment inlet.
- $x_{seg,out,2P1}$ is the vapor quality at the segment outlet.

The expression is based on the work of Cavallini and Zecchin [5], which derives a heat transfer coefficient correlation at a local vapor quality x . Equations for the liquid-vapor mixture are obtained by averaging Cavallini and Zecchin's correlation over the segment from $x_{seg,in,2P1}$ to $x_{seg,out,2P1}$.

Two-Phase Fluid 1 Weighted Average

The two-phase fluid flow through a segment may not be entirely represented as either subcooled liquid, superheated vapor, or liquid-vapor mixture. Instead, each segment may consist of a combination of these. The block approximates this condition by computing weighting factors based on the change in specific enthalpy across the segment and the saturated liquid and vapor specific enthalpies:

$$w_L = \frac{|\min(h_{seg,out,2P1}, h_{seg,SL,2P1}) - \min(h_{seg,in,2P1}, h_{seg,SL,2P1})|}{|h_{seg,out,2P1} - h_{seg,in,2P1}|}$$

$$w_V = \frac{|\max(h_{seg,out,2P1}, h_{seg,SV,2P1}) - \max(h_{seg,in,2P1}, h_{seg,SV,2P1})|}{|h_{seg,out,2P1} - h_{seg,in,2P1}|}$$

$$w_M = 1 - w_L - w_V$$

where:

- $h_{seg,in,2P1}$ is the specific enthalpy at the segment inlet.
- $h_{seg,out,2P1}$ is the specific enthalpy at the segment outlet.
- $h_{seg,SL,2P1}$ is the saturated liquid specific enthalpy for the segment.
- $h_{seg,SV,2P1}$ is the saturated vapor specific enthalpy for the segment.

The weighted-average two-phase fluid 1 heat transfer conductance for the segment is therefore

$$UA_{seg,2P1} = w_L(UA_{seg,L,2P1}) + w_V(UA_{seg,V,2P1}) + w_M(UA_{seg,M,2P1}).$$

The weighted-average fluid 1 temperature for the segment is

$$T_{seg,2P1} = \frac{w_L(UA_{seg,L,2P1})T_{seg,L,2P1} + w_V(UA_{seg,V,2P1})T_{seg,V,2P1} + w_M(UA_{seg,M,2P1})T_{seg,M,2P1}}{UA_{seg,2P1}},$$

where:

- $T_{seg,L,2P1}$ is the average liquid temperature for the segment.
- $T_{seg,V,2P1}$ is the average vapor temperature for the segment.
- $T_{seg,M,2P1}$ is the average mixture temperature for the segment, which is the saturated liquid temperature.

Two-Phase Fluid 2 Heat Transfer Correlation

If the segment is subcooled liquid, then the heat transfer conductance is

$$UA_{seg,L,2P2} = a_{L,2P2} (Re_{seg,L,2P2})^{b_{2P2}} (Pr_{seg,L,2P2})^{c_{2P2}} k_{seg,L,2P2} \frac{G_{2P2}}{N},$$

where:

- $a_{L,2P2}$, $b_{L,2P2}$, and $c_{L,2P2}$ are the coefficients of the Nusselt number correlation. These coefficients appear as block parameters in the **Correlation Coefficients** section.
- $Re_{seg,L,2P2}$ is the average liquid Reynolds number for the segment.
- $Pr_{seg,L,2P2}$ is the average liquid Prandtl number for the segment.
- $k_{seg,L,2P2}$ is the average liquid thermal conductivity for the segment.
- G_{2P2} is the geometry scale factor for the two-phase fluid 2 side of the heat exchanger. The block calculates the geometry scale factor so that the total heat transfer over all segments matches the specified performance at the nominal operating conditions.

The average liquid Reynolds number is

$$Re_{seg,L,2P2} = \frac{\dot{m}_{seg,2P2} D_{ref,2P2}}{\mu_{seg,L,2P2} S_{ref,2P2}},$$

where:

- $\dot{m}_{seg,2P2}$ is the mass flow rate through the segment.
- $\mu_{seg,L,2P2}$ is the average liquid dynamic viscosity for the segment.
- $D_{ref,2P2}$ is an arbitrary reference diameter.
- $S_{ref,2P2}$ is an arbitrary reference flow area.

Note The $D_{ref,2P2}$ and $S_{ref,2P2}$ terms are included in this equation for unit calculation purposes only, to make $Re_{seg,L,2P2}$ nondimensional. The values of $D_{ref,2P2}$ and $S_{ref,2P2}$ are arbitrary because the G_{2P2} calculation overrides these values.

Similarly, if the segment is superheated vapor, then the heat transfer conductance is

$$UA_{seg,V,2P2} = a_{V,2P2} (Re_{seg,V,2P2})^{b_{2P2}} (Pr_{seg,V,2P2})^{c_{2P2}} k_{seg,V,2P2} \frac{G_{2P2}}{N},$$

where:

- $a_{V,2P2}$, $b_{V,2P2}$, and $c_{V,2P2}$ are the coefficients of the Nusselt number correlation. These coefficients appear as block parameters in the **Correlation Coefficients** section.
- $Re_{seg,V,2P2}$ is the average vapor Reynolds number for the segment.

- $Pr_{seg,V,2P2}$ is the average vapor Prandtl number for the segment.
- $k_{seg,V,2P2}$ is the average vapor thermal conductivity for the segment.

The average vapor Reynolds number is

$$Re_{seg,V,2P2} = \frac{\dot{m}_{seg,2P2} D_{ref,2P2}}{\mu_{seg,V,2P2} S_{ref,2P2}},$$

where $\mu_{seg,V,2P2}$ is the average vapor dynamic viscosity for the segment.

If the segment is liquid-vapor mixture, then the heat transfer conductance is

$$UA_{seg,M,2P2} = a_{M,2P2} (Re_{seg,SL,2P2})^{b_{2P2}} CZ (Pr_{seg,SL,2P2})^{c_{2P2}} k_{seg,SL,2P2} \frac{G_{2P2}}{N},$$

where:

- $a_{M,2P2}$, $b_{L,2P2}$, and $c_{L,2P2}$ are the coefficients of the Nusselt number correlation. These coefficients appear as block parameters in the **Correlation Coefficients** section.
- $Re_{seg,SL,2P2}$ is the saturated liquid Reynolds number for the segment.
- $Pr_{seg,SL,2P2}$ is the saturated liquid Prandtl number for the segment.
- $k_{seg,SL,2P2}$ is the saturated liquid thermal conductivity for the segment.
- CZ is the Cavallini and Zecchin term.

The saturated liquid Reynolds number is

$$Re_{seg,SL,2P2} = \frac{\dot{m}_{seg,2P2} D_{ref,2P2}}{\mu_{seg,SL,2P2} S_{ref,2P2}},$$

where $\mu_{seg,SL,2P2}$ is the saturated liquid dynamic viscosity for the segment.

The Cavallini and Zecchin term is

$$CZ = \frac{\left(\left(\sqrt{\frac{\nu_{seg,SV,2P2}}{\nu_{seg,SL,2P2}}} - 1 \right) (x_{seg,out,2P2} + 1) \right)^{1+b_{2P2}} - \left(\left(\sqrt{\frac{\nu_{seg,SV,2P2}}{\nu_{seg,SL,2P2}}} - 1 \right) (x_{seg,in,2P2} + 1) \right)^{1+b_{2P2}}}{(1+b_{2P2}) \left(\sqrt{\frac{\nu_{seg,SV,2P2}}{\nu_{seg,SL,2P2}}} - 1 \right) (x_{seg,out,2P2} - x_{seg,in,2P2})},$$

where:

- $\nu_{seg,SL,2P2}$ is the saturated liquid specific volume for the segment.
- $\nu_{seg,SV,2P2}$ is the saturated vapor specific volume for the segment.
- $x_{seg,in,2P2}$ is the vapor quality at the segment inlet.
- $x_{seg,out,2P2}$ is the vapor quality at the segment outlet.

The expression is based on the work of Cavallini and Zecchin [5], which derives a heat transfer coefficient correlation at a local vapor quality x . Equations for the liquid-vapor mixture are obtained by averaging Cavallini and Zecchin's correlation over the segment from $x_{seg,in,2P2}$ to $x_{seg,out,2P2}$.

Two-Phase Fluid 2 Weighted Average

The two-phase fluid flow through a segment may not be entirely represented as either subcooled liquid, superheated vapor, or liquid-vapor mixture. Instead, each segment may consist of a

combination of these. The block approximates this condition by computing weighting factors based on the change in specific enthalpy across the segment and the saturated liquid and vapor specific enthalpies:

$$w_L = \frac{|\min(h_{seg, out, 2P2}, h_{seg, SL, 2P2}) - \min(h_{seg, in, 2P2}, h_{seg, SL, 2P2})|}{|h_{seg, out, 2P2} - h_{seg, in, 2P2}|}$$

$$w_V = \frac{|\max(h_{seg, out, 2P2}, h_{seg, SV, 2P2}) - \max(h_{seg, in, 2P2}, h_{seg, SV, 2P2})|}{|h_{seg, out, 2P2} - h_{seg, in, 2P2}|}$$

$$w_M = 1 - w_L - w_V$$

where:

- $h_{seg, in, 2P2}$ is the specific enthalpy at the segment inlet.
- $h_{seg, out, 2P2}$ is the specific enthalpy at the segment outlet.
- $h_{seg, SL, 2P2}$ is the saturated liquid specific enthalpy for the segment.
- $h_{seg, SV, 2P2}$ is the saturated vapor specific enthalpy for the segment.

The weighted-average two-phase fluid 2 heat transfer conductance for the segment is therefore

$$UA_{seg, 2P2} = w_L(UA_{seg, L, 2P2}) + w_V(UA_{seg, V, 2P2}) + w_M(UA_{seg, M, 2P2}).$$

The weighted-average fluid 2 temperature for the segment is

$$T_{seg, 2P2} = \frac{w_L(UA_{seg, L, 2P2})T_{seg, L, 2P2} + w_V(UA_{seg, V, 2P2})T_{seg, V, 2P2} + w_M(UA_{seg, M, 2P2})T_{seg, M, 2P2}}{UA_{seg, 2P2}},$$

where:

- $T_{seg, L, 2P2}$ is the average liquid temperature for the segment.
- $T_{seg, V, 2P2}$ is the average vapor temperature for the segment.
- $T_{seg, M, 2P2}$ is the average mixture temperature for the segment, which is the saturated liquid temperature.

Pressure Loss

The pressure losses on the two-phase fluid 1 side are

$$p_{A, 2P1} - p_{2P1} = \frac{K_{2P1} \dot{m}_{A, 2P1} \sqrt{\dot{m}_{A, 2P1}^2 + \dot{m}_{thres, 2P1}^2}}{2 \rho_{avg, 2P1}}$$

$$p_{B, 2P1} - p_{2P1} = \frac{K_{2P1} \dot{m}_{B, 2P1} \sqrt{\dot{m}_{B, 2P1}^2 + \dot{m}_{thres, 2P1}^2}}{2 \rho_{avg, 2P1}}$$

where:

- $p_{A, 2P1}$ and $p_{B, 2P1}$ are the pressures at ports **A1** and **B1**, respectively.
- p_{2P1} is internal two-phase fluid 1 pressure at which the heat transfer is calculated.
- $\dot{m}_{A, 2P1}$ and $\dot{m}_{B, 2P1}$ are the mass flow rates into ports **A1** and **B1**, respectively.
- $\rho_{avg, 2P1}$ is the average two-phase fluid 1 density over all segments.

- $\dot{m}_{thres, 2P1}$ is the laminar threshold for pressure loss, approximated as 1e-4 of the nominal mass flow rate. The block calculates the pressure loss coefficient, K_{2P1} , so that $p_{A,2P1} - p_{B,2P1}$ matches the nominal pressure loss at the nominal mass flow rate.

The pressure losses on the two-phase fluid 2 side are

$$p_{A, 2P2} - p_{2P2} = \frac{K_{2P2} \dot{m}_{A, 2P2} \sqrt{\dot{m}_{A, 2P2}^2 + \dot{m}_{thres, 2P2}^2}}{2 \rho_{avg, 2P2}}$$

$$p_{B, 2P2} - p_{2P2} = \frac{K_{2P2} \dot{m}_{B, 2P2} \sqrt{\dot{m}_{B, 2P2}^2 + \dot{m}_{thres, 2P2}^2}}{2 \rho_{avg, 2P2}}$$

where:

- $p_{A,2P2}$ and $p_{B,2P2}$ are the pressures at ports **A2** and **B2**, respectively.
- p_{2P2} is internal two-phase fluid 2 pressure at which the heat transfer is calculated.
- $\dot{m}_{A, 2P2}$ and $\dot{m}_{B, 2P2}$ are the mass flow rates into ports **A2** and **B2**, respectively.
- $\rho_{avg, 2P2}$ is the average two-phase fluid 2 density over all segments.
- $\dot{m}_{thres, 2P2}$ is the laminar threshold for pressure loss, approximated as 1e-4 of the nominal mass flow rate. The block calculates the pressure loss coefficient, K_{2P2} , so that $p_{A,2P2} - p_{B,2P2}$ matches the nominal pressure loss at the nominal mass flow rate.

Two-Phase Fluid 1 Mass and Energy Conservation

The mass conservation equation for the overall two-phase fluid 1 flow is

$$\left(\frac{dp_{2P1}}{dt} \sum_{segments} \left(\frac{\partial \rho_{seg, 2P1}}{\partial p} \right) + \sum_{segments} \left(\frac{du_{seg, 2P1}}{dt} \frac{\partial \rho_{seg, 2P1}}{\partial u} \right) \right) \frac{V_{2P1}}{N} = \dot{m}_{A, 2P1} + \dot{m}_{B, 2P1},$$

where:

- $\frac{\partial \rho_{seg, 2P1}}{\partial p}$ is the partial derivative of density with respect to pressure for the segment.
- $\frac{\partial \rho_{seg, 2P1}}{\partial u}$ is the partial derivative of density with respect to specific internal energy for the segment.
- $u_{seg, 2P1}$ is the specific internal energy for the segment.
- V_{2P1} is the total two-phase fluid 1 volume.

The summation is over all segments.

Note Although the two-phase fluid 1 flow is divided into $N=3$ segments for heat transfer calculations, all segments are assumed to be at the same internal pressure, p_{2P1} . That is why p_{2P1} is outside of the summation.

The energy conservation equation for each segment is

$$\frac{du_{seg, 2P1}}{dt} \frac{M_{2P1}}{N} + u_{seg, 2P1} (\dot{m}_{seg, in, 2P1} - \dot{m}_{seg, out, 2P1}) = \Phi_{seg, in, 2P1} - \Phi_{seg, out, 2P1} + Q_{seg, 2P1},$$

where:

- M_{2P1} is the total two-phase fluid 1 mass.
- $\dot{m}_{seg, in, 2P1}$ and $\dot{m}_{seg, out, 2P1}$ are the mass flow rates into and out of the segment.
- $\Phi_{seg, in, 2p1}$ and $\Phi_{seg, out, 2p1}$ are the energy flow rates into and out of the segment.

The mass flow rates between segments are assumed to be linearly distributed between the values of $\dot{m}_{A, 2P1}$ and $\dot{m}_{B, 2P1}$.

Two-Phase Fluid 2 Mass and Energy Conservation

The mass conservation equation for the overall two-phase fluid 2 flow is

$$\left(\frac{dp_{2P2}}{dt} \sum_{segments} \left(\frac{\partial \rho_{seg, 2P2}}{\partial p} \right) + \sum_{segments} \left(\frac{du_{seg, 2P2}}{dt} \frac{\partial \rho_{seg, 2P2}}{\partial u} \right) \right) \frac{V_{2P2}}{N} = \dot{m}_{A, 2P2} + \dot{m}_{B, 2P2},$$

where:

- $\frac{\partial \rho_{seg, 2P2}}{\partial p}$ is the partial derivative of density with respect to pressure for the segment.
- $\frac{\partial \rho_{seg, 2P2}}{\partial u}$ is the partial derivative of density with respect to specific internal energy for the segment.
- $u_{seg, 2P2}$ is the specific internal energy for the segment.
- V_{2P2} is the total two-phase fluid 2 volume.

The summation is over all segments.

Note Although the two-phase fluid 2 flow is divided into $N=3$ segments for heat transfer calculations, all segments are assumed to be at the same internal pressure, p_{2P2} . That is why p_{2P2} is outside of the summation.

The energy conservation equation for each segment is

$$\frac{du_{seg, 2P2}}{dt} \frac{M_{2P2}}{N} + u_{seg, 2P2} (\dot{m}_{seg, in, 2P2} - \dot{m}_{seg, out, 2P2}) = \Phi_{seg, in, 2P2} - \Phi_{seg, out, 2P2} + Q_{seg, 2P2},$$

where:

- M_{2P2} is the total two-phase fluid 2 mass.
- $\dot{m}_{seg, in, 2P2}$ and $\dot{m}_{seg, out, 2P2}$ are the mass flow rates into and out of the segment.
- $\Phi_{seg, in, 2p2}$ and $\Phi_{seg, out, 2p2}$ are the energy flow rates into and out of the segment.

The mass flow rates between segments are assumed to be linearly distributed between the values of $\dot{m}_{A, 2P2}$ and $\dot{m}_{B, 2P2}$.

Ports

Output

Q1 — Rate of heat transfer to two-phase fluid 1, W

physical signal

Rate of heat transfer to the first two-phase fluid network, returned as a physical signal. Physical signals **Q1** and **Q2** are usually equal in value with opposite sign. However, if the **Wall thermal mass** parameter is set to On, then these two signals may have different values because the wall may absorb and release some of the heat being transferred.

Q2 — Rate of heat transfer to two-phase fluid 2, W

physical signal

Rate of heat transfer to the second two-phase fluid network, returned as a physical signal. Physical signals **Q1** and **Q2** are usually equal in value with opposite sign. However, if the **Wall thermal mass** parameter is set to On, then these two signals may have different values because the wall may absorb and release some of the heat being transferred.

Conserving

A1 — Two-phase fluid port on side 1

two-phase fluid

Inlet or outlet port associated with the first two-phase fluid network.

B1 — Two-phase fluid port on side 1

two-phase fluid

Inlet or outlet port associated with the first two-phase fluid network.

A2 — Two-phase fluid port on side 2

moist air

Inlet or outlet port associated with the second two-phase fluid network.

B2 — Two-phase fluid port on side 2

moist air

Inlet or outlet port associated with the second two-phase fluid network.

Parameters

Configuration

Wall thermal mass — Enable or disable effect of thermal mass on heat transfer surface

Off (default) | On

Enable or disable the effect of thermal mass on the heat transfer surface. Setting this parameter to On introduces additional dynamics to the simulation, so that it takes longer to reach steady state, but does not affect the results at steady-state simulation.

Wall mass — Mass of heat transfer surface

1 kg (default) | positive scalar

Mass of the heat transfer surface.

Dependencies

To enable this parameter, set **Wall thermal mass** to 0n.

Wall specific heat — Specific heat of heat transfer surface

490 J/(K*kg) (default) | positive scalar

Specific heat of the heat transfer surface.

Dependencies

To enable this parameter, set **Wall thermal mass** to 0n.

Cross-sectional area at port A1 — Flow area at port A1

0.01 m² (default) | positive scalar

Flow area at the two-phase fluid 1 port **A1**.

Cross-sectional area at port B1 — Flow area at port B1

0.01 m² (default) | positive scalar

Flow area at the two-phase fluid 1 port **B1**.

Cross-sectional area at port A2 — Flow area at port A2

0.01 m² (default) | positive scalar

Flow area at the two-phase fluid 2 port **A2**.

Cross-sectional area at port B2 — Area normal to flow at port B2

0.01 m² (default) | positive scalar

Flow area at the two-phase fluid 2 port **B2**.

Two-Phase Fluid 1**Nominal operating condition — Select whether nominal operating condition corresponds to condenser or evaporator**

Heat transfer from two-phase fluid 1 to two-phase fluid 2 (default) | Heat transfer from two-phase fluid 2 to two-phase fluid 1

Select the nominal operating condition:

- Heat transfer from two-phase fluid 1 to two-phase fluid 2 — Side 1 is being cooled and side 2 is being heated.
- Heat transfer from two-phase fluid 2 to two-phase fluid 1 — Side 2 is being cooled and side1 is being heated.

This choice relates only to specifying the nominal operating condition parameters. It does not mean that heat transfer can only happen in the specified direction during simulation.

Nominal mass flow rate — Mass flow rate between two-phase fluid side 1 ports during nominal operating condition

0.001 kg/s (default) | positive scalar

Mass flow rate from port **A1** to port **B1** during the nominal operating condition.

Nominal pressure drop — Pressure drop between two-phase fluid side 1 ports during nominal operating condition

0.001 MPa (default) | positive scalar

Pressure drop from port **A1** to port **B1** during the nominal operating condition.

Pressure specification — Select method of pressure specification

Inlet pressure (default) | Saturation pressure at specified condensing temperature
| Saturation pressure at specified evaporating temperature

Select the method of pressure specification:

- Inlet pressure — Specify the nominal inlet pressure.
- Saturation pressure at specified saturation temperature — Specify the nominal saturation temperature.

Nominal inlet pressure — Pressure at the two-phase fluid side 1 inlet

1 MPa (default) | positive scalar

Pressure at the inlet of the two-phase fluid side 1 of the heat exchanger during nominal operating condition.

Dependencies

To enable this parameter, set **Pressure specification** to Inlet pressure.

Nominal saturation temperature — Use nominal saturation temperature to specify pressure

313.15 K (default) | positive scalar

Saturation temperature at the outlet of the two-phase fluid side 1 of the heat exchanger during nominal operating condition. The pressure in the heat exchanger is the corresponding saturation pressure. The nominal saturation temperature must be less than the critical temperature.

Dependencies

To enable this parameter, set **Pressure specification** to Saturation pressure at specified saturation temperature.

Inlet condition specification — Select quantity to describe the inlet condition of the two-phase fluid side 1

Specific enthalpy (default) | Temperature | Vapor quality

Quantity used to describe the inlet condition of the fluid at the nominal operating condition: temperature, specific enthalpy, or vapor quality.

Nominal inlet specific enthalpy — Specific enthalpy at the two-phase fluid side 1 inlet

440 kJ/kg (default) | positive scalar

Specific enthalpy at the inlet of the two-phase fluid side 1 of the heat exchanger during the nominal operating condition.

Dependencies

To enable this parameter, set **Inlet condition specification** to Specific enthalpy.

Nominal inlet temperature — Temperature at the two-phase fluid side 1 inlet

313.15 K (default) | positive scalar

Temperature at the inlet of the two-phase fluid side 1 of the heat exchanger during the nominal operating condition.

Dependencies

To enable this parameter, set **Inlet condition specification** to Temperature.

Nominal inlet vapor quality — Vapor quality at the two-phase fluid side 1 inlet

1 (default) | positive scalar

Vapor quality, defined as the mass fraction of vapor in a liquid-vapor mixture, at the inlet of the two-phase fluid side 1 of the heat exchanger during the nominal operating condition.

Dependencies

To enable this parameter, set **Inlet condition specification** to Vapor quality.

Heat transfer capacity specification — Select how to specify heat transfer capacity of the two-phase fluid side 1

Rate of heat transfer (default) | Outlet condition

Select whether to specify the performance of the heat exchanger at the nominal operating condition directly, by the rate of heat transfer, or indirectly, by the outlet condition.

Nominal rate of heat transfer — Specify performance by rate of heat transfer

0.1 kW (default) | positive scalar

Rate of heat transfer, depending on the nominal operating condition:

- If **Nominal operating condition** is Heat transfer from two-phase fluid 1 to two-phase fluid 2, rate of heat transfer from the two-phase fluid side 1 to side 2 during the nominal operating condition.
- If **Nominal operating condition** is Heat transfer from two-phase fluid 2 to two-phase fluid 1, rate of heat transfer from the two-phase fluid side 2 to side 1 during the nominal operating condition.

Dependencies

To enable this parameter, set **Heat transfer capacity specification** to Rate of heat transfer.

Outlet condition specification — Select quantity for outlet condition specification

Specific enthalpy (default) | Subcooling | Superheating | Vapor quality

Select the quantity for outlet condition specification:

- Specific enthalpy — Specify the nominal specific enthalpy.
- Subcooling — Specify the nominal subcooling. This option is available if you set **Nominal operating condition** to Heat transfer from two-phase fluid 1 to two-phase fluid 2.
- Superheating — Specify the nominal superheating. This option is available if you set **Nominal operating condition** to Heat transfer from two-phase fluid 2 to two-phase fluid 1.

- Vapor quality — Specify the nominal vapor quality.

Dependencies

To enable this parameter, set **Heat transfer capacity specification** to Outlet condition.

Nominal outlet specific enthalpy — Specific enthalpy at the two-phase fluid side 1 outlet

250 kJ/kg (default) | positive scalar | two-element vector

Specific enthalpy at the outlet of the two-phase fluid side 1 of the heat exchanger during the nominal operating condition.

Dependencies

To enable this parameter, set **Outlet condition specification** to Specific enthalpy.

Nominal subcooling — Degree of temperature below the liquid saturation temperature at the two-phase fluid side 1 outlet

5 deltaK (default) | positive scalar

Degree of temperature below the liquid saturation temperature at the outlet of the two-phase fluid side 1 of the heat exchanger during the nominal operating condition.

Dependencies

To enable this parameter, set **Outlet condition specification** to Subcooling.

Nominal superheating — Degree of temperature above the vapor saturation temperature at the two-phase fluid side 1 outlet

5 deltaK (default) | positive scalar

Degree of temperature above the vapor saturation temperature at the outlet of the two-phase fluid side 1 of the heat exchanger during the nominal operating condition.

Dependencies

To enable this parameter, set **Outlet condition specification** to Superheating.

Nominal outlet vapor quality — Vapor mass fraction at the two-phase fluid side 1 outlet

0 (default) | scalar in the range [0,1]

Two-phase fluid vapor quality, defined as the mass fraction of vapor in a liquid-vapor mixture, at the outlet of the two-phase fluid side 1 of the heat exchanger during the nominal operating condition.

If using this option, the initial pressure cannot be higher than the critical pressure.

Dependencies

To enable this parameter, set **Outlet condition specification** to Vapor quality.

Two-phase fluid 1 volume — Total volume of two-phase fluid 1

0.001 m³ (default) | positive scalar

Total volume of two-phase fluid 1 inside the heat exchanger.

Initial condition specification — Select how to specify initial state of two-phase fluid 1

Same as nominal operating condition (default) | Specify initial condition

Select how to specify initial state of two-phase fluid 1:

- Same as nominal operating condition — Start the simulation at the nominal operating condition.
- Specify initial condition — Specify a different set of initial conditions using additional parameters.

Initial fluid energy specification — Initial state of the two-phase fluid 1

Specific enthalpy (default) | Temperature | Vapor quality | Vapor void fraction | Specific internal energy

Quantity used to describe the initial state of the side 1 fluid: temperature, vapor quality, vapor void fraction, specific enthalpy, or specific internal energy.

DependenciesTo enable this parameter, set **Initial condition specification** to Specify initial condition.**Initial two-phase fluid 1 pressure — Fluid 1 pressure at start of simulation**

0.101325 MPa (default) | positive scalar

Two-phase fluid 1 pressure at the start of the simulation.

Initial two-phase fluid 1 specific enthalpy — Enthalpy per unit mass at start of simulation

1500 kJ/kg (default) | positive scalar | two-element vector

Two-phase fluid 1 specific enthalpy at the start of simulation. If the value is a scalar, then the initial specific enthalpy is assumed uniform. If the value is a two-element vector, then the initial specific enthalpy is assumed to vary linearly between ports **A1** and **B1**, with the first element corresponding to port **A1** and the second element corresponding to port **B1**.**Dependencies**To enable this parameter, set **Initial fluid energy specification** to Specific enthalpy.**Initial two-phase fluid 1 temperature — Temperature at start of simulation**

293.15 K (default) | positive scalar | two-element vector

Two-phase fluid 1 temperature at the start of simulation. If the value is a scalar, then the initial temperature is assumed uniform. If the value is a two-element vector, then the initial temperature is assumed to vary linearly between ports **A1** and **B1**, with the first element corresponding to port **A1** and the second element corresponding to port **B1**.**Dependencies**To enable this parameter, set **Initial fluid energy specification** to Temperature.**Initial two-phase fluid 1 vapor quality — Vapor mass fraction at start of simulation**

0.5 (default) | scalar in the range [0,1] | two-element vector

Two-phase fluid 1 vapor quality, defined as the mass fraction of vapor in a liquid-vapor mixture, at the start of simulation. If the value is a scalar, then the initial vapor quality is assumed uniform. If the

value is a two-element vector, then the initial vapor quality is assumed to vary linearly between ports **A1** and **B1**, with the first element corresponding to port **A1** and the second element corresponding to port **B1**.

If using this option, the initial pressure cannot be higher than the critical pressure.

Dependencies

To enable this parameter, set **Initial fluid energy specification** to Vapor quality.

Initial two-phase fluid 1 vapor void fraction – Vapor volume fraction at start of simulation

0.5 (default) | scalar in the range [0,1] | two-element vector

Two-phase fluid 1 vapor void fraction, defined as the volume fraction of vapor in a liquid-vapor mixture, at the start of simulation. If the value is a scalar, then the initial vapor void fraction is assumed uniform. If the value is a two-element vector, then the initial vapor void fraction is assumed to vary linearly between ports **A1** and **B1**, with the first element corresponding to port **A1** and the second element corresponding to port **B1**.

If using this option, the initial pressure cannot be higher than the critical pressure.

Dependencies

To enable this parameter, set **Initial fluid energy specification** to Vapor void fraction.

Initial two-phase fluid 1 specific internal energy – Internal energy per unit mass at start of simulation

1500 kJ/kg (default) | positive scalar | two-element vector

Two-phase fluid 1 specific internal energy at the start of simulation. If the value is a scalar, then the initial specific internal energy is assumed uniform. If the value is a two-element vector, then the initial specific internal energy is assumed to vary linearly between ports **A1** and **B1**, with the first element corresponding to port **A1** and the second element corresponding to port **B1**.

Dependencies

To enable this parameter, set **Initial fluid energy specification** to Specific internal energy.

Two-Phase Fluid 2

Nominal mass flow rate – Mass flow rate between two-phase fluid side 2 ports during nominal operating condition

0.001 kg/s (default) | positive scalar

Mass flow rate from port **A2** to port **B2** during the nominal operating condition.

Nominal pressure drop – Pressure drop between two-phase fluid side 2 ports during nominal operating condition

0.001 MPa (default) | positive scalar

Pressure drop from port **A2** to port **B2** during the nominal operating condition.

Pressure specification – Select method of pressure specification

Inlet pressure (default) | Saturation pressure at specified condensing temperature
| Saturation pressure at specified evaporating temperature

Select the method of pressure specification:

- **Inlet pressure** — Specify the nominal inlet pressure.
- **Saturation pressure at specified saturation temperature** — Specify the nominal saturation temperature.

Nominal inlet pressure — Pressure at the two-phase fluid side inlet

1 MPa (default) | positive scalar

Pressure at the inlet of the two-phase fluid side 2 of the heat exchanger during nominal operating condition.

Dependencies

To enable this parameter, set **Pressure specification** to **Inlet pressure**.

Nominal saturation temperature — Use nominal saturation temperature to specify pressure

243.15 K (default) | positive scalar

Saturation temperature at the outlet of the two-phase fluid side 2 of the heat exchanger during nominal operating condition. The pressure in the heat exchanger is the corresponding saturation pressure. The nominal saturation temperature must be less than the critical temperature.

Dependencies

To enable this parameter, set **Pressure specification** to **Saturation pressure at specified saturation temperature**.

Inlet condition specification — Select quantity to describe the inlet condition of the two-phase fluid side 2

Specific enthalpy (default) | Temperature | Vapor quality

Quantity used to describe the inlet condition of the fluid at the nominal operating condition: temperature, specific enthalpy, or vapor quality.

Nominal inlet specific enthalpy — Specific enthalpy at the two-phase fluid side 2 inlet

250 kJ/kg (default) | positive scalar

Specific enthalpy at the inlet of the two-phase fluid side 2 of the heat exchanger during the nominal operating condition.

Dependencies

To enable this parameter, set **Inlet condition specification** to **Specific enthalpy**.

Nominal inlet temperature — Temperature at the two-phase fluid side 2 inlet

237.15 K (default) | positive scalar

Temperature at the inlet of the two-phase fluid side 2 of the heat exchanger during the nominal operating condition.

Dependencies

To enable this parameter, set **Inlet condition specification** to **Temperature**.

Nominal inlet vapor quality — Vapor quality at the two-phase fluid side 2 inlet

0.1 (default) | positive scalar

Vapor quality, defined as the mass fraction of vapor in a liquid-vapor mixture, at the inlet of the two-phase fluid side 2 of the heat exchanger during the nominal operating condition.

Dependencies

To enable this parameter, set **Inlet condition specification** to Vapor quality.

Two-phase fluid 2 volume — Total volume of two-phase fluid 20.001 m³ (default) | positive scalar

Total volume of two-phase fluid 2 inside the heat exchanger.

Initial condition specification — Select how to specify initial state of two-phase fluid 2

Same as nominal operating condition (default) | Specify initial condition

Select how to specify initial state of two-phase fluid 2:

- Same as nominal operating condition — Start the simulation at the nominal operating condition.
- Specify initial condition — Specify a different set of initial conditions using additional parameters.

Initial fluid energy specification — Initial state of the two-phase fluid 2

Specific enthalpy (default) | Temperature | Vapor quality | Vapor void fraction | Specific internal energy

Quantity used to describe the initial state of the side 2 fluid: temperature, vapor quality, vapor void fraction, specific enthalpy, or specific internal energy.

Dependencies

To enable this parameter, set **Initial condition specification** to Specify initial condition.

Initial two-phase fluid 2 pressure — Fluid 2 pressure at start of simulation

0.101325 MPa (default) | positive scalar

Two-phase fluid 2 pressure at the start of the simulation.

Initial two-phase fluid 2 specific enthalpy — Enthalpy per unit mass at start of simulation

1500 kJ/kg (default) | positive scalar | two-element vector

Two-phase fluid 2 specific enthalpy at the start of simulation. If the value is a scalar, then the initial specific enthalpy is assumed uniform. If the value is a two-element vector, then the initial specific enthalpy is assumed to vary linearly between ports **A2** and **B2**, with the first element corresponding to port **A2** and the second element corresponding to port **B2**.

Dependencies

To enable this parameter, set **Initial fluid energy specification** to Specific enthalpy.

Initial two-phase fluid 2 temperature — Temperature at start of simulation

293.15 K (default) | positive scalar | two-element vector

Two-phase fluid 2 temperature at the start of simulation. If the value is a scalar, then the initial temperature is assumed uniform. If the value is a two-element vector, then the initial temperature is assumed to vary linearly between ports **A2** and **B2**, with the first element corresponding to port **A2** and the second element corresponding to port **B2**.

Dependencies

To enable this parameter, set **Initial fluid energy specification** to Temperature.

Initial two-phase fluid 2 vapor quality – Vapor mass fraction at start of simulation

0.5 (default) | scalar in the range [0,1] | two-element vector

Two-phase fluid 2 vapor quality, defined as the mass fraction of vapor in a liquid-vapor mixture, at the start of simulation. If the value is a scalar, then the initial vapor quality is assumed uniform. If the value is a two-element vector, then the initial vapor quality is assumed to vary linearly between ports **A2** and **B2**, with the first element corresponding to port **A2** and the second element corresponding to port **B2**.

If using this option, the initial pressure cannot be higher than the critical pressure.

Dependencies

To enable this parameter, set **Initial fluid energy specification** to Vapor quality.

Initial two-phase fluid 2 vapor void fraction – Vapor volume fraction at start of simulation

0.5 (default) | scalar in the range [0,1] | two-element vector

Two-phase fluid 2 vapor void fraction, defined as the volume fraction of vapor in a liquid-vapor mixture, at the start of simulation. If the value is a scalar, then the initial vapor void fraction is assumed uniform. If the value is a two-element vector, then the initial vapor void fraction is assumed to vary linearly between ports **A2** and **B2**, with the first element corresponding to port **A2** and the second element corresponding to port **B2**.

If using this option, the initial pressure cannot be higher than the critical pressure.

Dependencies

To enable this parameter, set **Initial fluid energy specification** to Vapor void fraction.

Initial two-phase fluid 2 specific internal energy – Internal energy per unit mass at start of simulation

1500 kJ/kg (default) | positive scalar | two-element vector

Two-phase fluid 2 specific internal energy at the start of simulation. If the value is a scalar, then the initial specific internal energy is assumed uniform. If the value is a two-element vector, then the initial specific internal energy is assumed to vary linearly between ports **A2** and **B2**, with the first element corresponding to port **A2** and the second element corresponding to port **B2**.

Dependencies

To enable this parameter, set **Initial fluid energy specification** to Specific internal energy.

Correlation Coefficients

a in $Nu = a \cdot Re^b \cdot Pr^c$ for two-phase fluid 1 liquid – Correlation coefficient for subcooled liquid in two-phase fluid 1

0.023 (default) | positive scalar

Proportionality constant in the correlation of Nusselt number as a function of Reynolds number and Prandtl number for subcooled liquid in two-phase fluid 1. The default value is based on the Colburn equation.

a in $Nu = a \cdot Re^b \cdot Pr^c$ for two-phase fluid 1 mixture – Correlation coefficient for liquid-vapor mixture in two-phase fluid 1

0.005 (default) | positive scalar

Proportionality constant in the correlation of Nusselt number as a function of Reynolds number and Prandtl number for liquid-vapor mixture in two-phase fluid 1. The default value is based on the Cavallini and Zecchin correlation.

a in $Nu = a \cdot Re^b \cdot Pr^c$ for two-phase fluid 1 vapor – Correlation coefficient for superheated vapor in two-phase fluid 1

0.023 (default) | positive scalar

Proportionality constant in the correlation of Nusselt number as a function of Reynolds number and Prandtl number for superheated vapor in two-phase fluid 1. The default value is based on the Colburn equation.

b in $Nu = a \cdot Re^b \cdot Pr^c$ for two-phase fluid 1 – Reynolds number exponent in correlation for two-phase fluid 1

0.8 (default) | positive scalar

Reynolds number exponent in the correlation of Nusselt number as a function of Reynolds number and Prandtl number for two-phase fluid 1. The same value applies to subcooled liquid, liquid-vapor mixture, and superheated vapor.

c in $Nu = a \cdot Re^b \cdot Pr^c$ for two-phase fluid 1 – Prandtl number exponent in correlation for two-phase fluid 1

0.33 (default) | positive scalar

Prandtl number exponent in the correlation of Nusselt number as a function of Reynolds number and Prandtl number for two-phase fluid 1. The same value applies to subcooled liquid, liquid-vapor mixture, and superheated vapor.

a in $Nu = a \cdot Re^b \cdot Pr^c$ for two-phase fluid 2 liquid – Correlation coefficient for subcooled liquid in two-phase fluid 2

0.023 (default) | positive scalar

Proportionality constant in the correlation of Nusselt number as a function of Reynolds number and Prandtl number for subcooled liquid in two-phase fluid 2. The default value is based on the Colburn equation.

a in $Nu = a \cdot Re^b \cdot Pr^c$ for two-phase fluid 2 mixture – Correlation coefficient for liquid-vapor mixture in two-phase fluid 2

0.005 (default) | positive scalar

Proportionality constant in the correlation of Nusselt number as a function of Reynolds number and Prandtl number for liquid-vapor mixture in two-phase fluid 2. The default value is based on the Cavallini and Zecchin correlation.

a in $Nu = a \cdot Re^b \cdot Pr^c$ for two-phase fluid 2 vapor — Correlation coefficient for superheated vapor in two-phase fluid 2

0.023 (default) | positive scalar

Proportionality constant in the correlation of Nusselt number as a function of Reynolds number and Prandtl number for superheated vapor in two-phase fluid 2. The default value is based on the Colburn equation.

b in $Nu = a \cdot Re^b \cdot Pr^c$ for two-phase fluid 2 — Reynolds number exponent in correlation for two-phase fluid 2

0.8 (default) | positive scalar

Reynolds number exponent in the correlation of Nusselt number as a function of Reynolds number and Prandtl number for two-phase fluid 2. The same value applies to subcooled liquid, liquid-vapor mixture, and superheated vapor.

c in $Nu = a \cdot Re^b \cdot Pr^c$ for two-phase fluid 2 — Prandtl number exponent in correlation for two-phase fluid 2

0.33 (default) | positive scalar

Prandtl number exponent in the correlation of Nusselt number as a function of Reynolds number and Prandtl number for two-phase fluid 2. The same value applies to subcooled liquid, liquid-vapor mixture, and superheated vapor.

Extended Capabilities

C/C++ Code Generation

Generate C and C++ code using Simulink® Coder™.

See Also

Introduced in R2021b

T-junction

Hydraulic resistance of T-junction in pipe



Library

Local Hydraulic Resistances

Description

The T-junction block represents a T-junction (wye connection) consisting, in general, of a main run and a branch merging to the main run. The junction as a hydraulic resistance is built of three Local Resistance blocks, as shown in the following diagram.

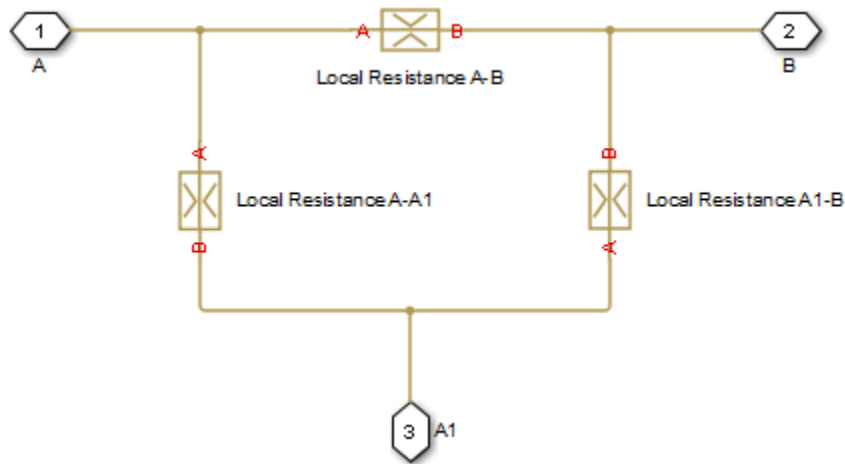

To specify pressure loss for all possible flow directions, you have to provide six pressure loss coefficients. The flow regime is checked in the underlying Local Resistance blocks by comparing the Reynolds number to the specified critical Reynolds number value, and depending on the result, the appropriate formula for pressure loss computation is used. For more information, see the reference documentation for the Local Resistance block.

The block positive direction is from port A to port B, from port A to port A1, and from port A1 to port B.

Basic Assumptions and Limitations

- Fluid inertia is not taken into account.

Parameters

Geometry Tab

Main pipe diameter

The internal pipe diameter of the main run. The default value is 0.01 m.

Branch pipe diameter

The internal pipe diameter of the branch. The default value is 0.01 m.

Laminar transition specification

Select how the block transitions between the laminar and turbulent regimes:

- **Pressure ratio** — The transition from laminar to turbulent regime is smooth and depends on the value of the **Laminar flow pressure ratio** parameter. This method provides better simulation robustness.
- **Reynolds number** — The transition from laminar to turbulent regime is assumed to take place when the Reynolds number reaches the value specified by the **Critical Reynolds number** parameter.

Laminar flow pressure ratio

Pressure ratio at which the flow transitions between laminar and turbulent regimes. The default value is 0.999. This parameter is visible only if the **Laminar transition specification** parameter is set to **Pressure ratio**.

Critical Reynolds number

The maximum Reynolds number for laminar flow. The value of the parameter depends on the orifice geometrical profile. You can find recommendations on the parameter value in hydraulics textbooks. The default value is 120. This parameter is visible only if the **Laminar transition specification** parameter is set to **Reynolds number**.

Pressure Loss Tab

A-B pressure loss coefficient

The pressure loss coefficient between ports A and B when fluid flows in the direction from A to B. The default value is 1.12.

B-A pressure loss coefficient

The pressure loss coefficient between ports A and B when fluid flows in the direction from B to A. The default value is 1.12.

A-A1 pressure loss coefficient

The pressure loss coefficient between ports A and A1 when fluid flows in the direction from A to A1. The default value is 1.36.

A1-A pressure loss coefficient

The pressure loss coefficient between ports A and A1 when fluid flows in the direction from A1 to A. The default value is 1.65.

A1-B pressure loss coefficient

The pressure loss coefficient between ports A1 and B when fluid flows in the direction from A1 to B. The default value is 1.6.

B-A1 pressure loss coefficient

The pressure loss coefficient between ports A1 and B when fluid flows in the direction from B to A1. The default value is 1.8.

Global Parameters

Parameters determined by the type of working fluid:

- **Fluid density**
- **Fluid kinematic viscosity**

Use the Hydraulic Fluid block or the Custom Hydraulic Fluid block to specify the fluid properties.

Ports

The block has the following ports:

A

Hydraulic conserving port associated with the main run inlet.

B

Hydraulic conserving port associated with the main run outlet.

A1

Hydraulic conserving port associated with the branch inlet.

Extended Capabilities**C/C++ Code Generation**

Generate C and C++ code using Simulink® Coder™.

See Also

Elbow | Gradual Area Change | Local Resistance | Pipe Bend | Sudden Area Change

Topics

“Upgrading Simscape Fluids Models Containing Hydraulics (Isothermal) Blocks”

Introduced in R2006b

T-Junction (IL)

Three-way junction in an isothermal liquid system

Library: Simscape / Fluids / Isothermal Liquid / Pipes & Fittings



Description

The T-Junction (IL) block models a three-way pipe junction with a branch line at port **C** connected at a 90° angle to the main pipe line, between ports **A** and **B**. You can specify a custom or standard junction type. When **Three-way junction type** is set to **Custom**, you can specify the loss coefficients of each pipe segment for converging and diverging flows. The standard model applies industry-standard loss coefficients to the momentum equations.

Flow Direction

The flow is *converging* when the branch flow, the flow through port **C**, merges into the main flow. The flow is *diverging* when the branch flow splits from the main flow. The flow direction between **A** and **I**, the point where the branch meets the main, and **B** and **I** must be consistent for all loss coefficients to be applied. If they are not, as shown in the last two diagrams in the figure below, the losses in the junction are approximated with the main branch loss coefficient for converging or diverging flows.

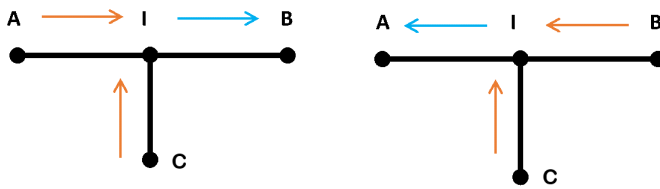

Converging Flows

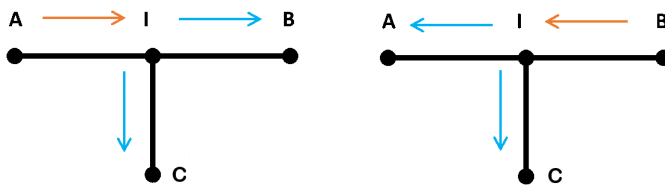

Diverging Flows

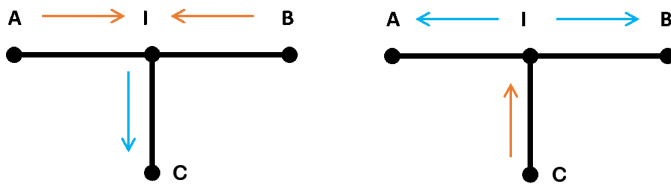

Approximated Flow Losses

Flow Scenarios

Standard T-Junction

When **Three-way junction type** is set to Standard, the pipe loss coefficients, K_{main} and K_{side} , and the pipe friction factor, f_T , are calculated according to Crane [1]:

$$K_{main} = 20f_{T, main}$$

$$K_{side} = 60f_{T, side}$$

In contrast to the custom junction type, the standard junction loss coefficient is the same for both converging and diverging flows. K_A , K_B , and K_C are then calculated in the same manner as custom junctions.

**PIPE FRICTION DATA FOR CLEAN COMMERCIAL STEEL PIPE
WITH FLOW IN ZONE OF COMPLETE TURBULENCE**

Nominal Size	1/2"	3/4"	1"	1 1/4"	1 1/2"	2"	2 1/2, 3"	4"	5"	6"	8-10"	12-16"	18-24"
Friction Factor (f_f)	.027	.025	.023	.022	.021	.019	.018	.017	.016	.015	.014	.013	.012

Friction Factor per Nominal Pipe Diameter

Custom T-Junction

When **Three-way junction type** is set to Custom, the pipe loss coefficient at each port, K , is calculated based on the user-defined loss parameters for converging and diverging flow and mass flow rate at each port. The coefficients are defined generally for positive and negative flows:

$$K_A = m_A^+ \left(\dot{m}_B^+ \dot{m}_C^- \frac{K_{main, conv}}{2} + \dot{m}_B^- \dot{m}_C^+ K_{main, conv} \right) + m_A^- \left(\dot{m}_B^+ \dot{m}_C^- K_{main, div} + \dot{m}_B^- \dot{m}_C^+ \frac{K_{main, div}}{2} \right),$$

where

- $K_{main, conv}$ is the **Main branch converging loss coefficient**.
- $K_{main, div}$ is the **Main branch diverging loss coefficient**.

$$K_B = m_A^+ \left(\dot{m}_B^+ \dot{m}_C^- \frac{K_{main, conv}}{2} + \dot{m}_B^- \dot{m}_C^- K_{main, div} \right) + m_A^- \left(\dot{m}_B^+ \dot{m}_C^+ K_{main, conv} + \dot{m}_B^- \dot{m}_C^+ \frac{K_{main, div}}{2} \right).$$

$$K_C = (m_A^+ \dot{m}_B^- + m_A^- \dot{m}_B^+) (\dot{m}_C^+ K_{side, conv} + \dot{m}_C^- K_{side, conv}),$$

where:

- $K_{side, conv}$ is the **Side branch converging loss coefficient**.
- $K_{side, div}$ is the **Side branch diverging loss coefficient**.

The positive mass flow direction at each port, when the flow direction is from **A** to **B**, from **A** to **C**, and from **C** to **B**, is defined as:

$$\dot{m}_{port}^+ = \frac{1 + \tanh\left(\frac{4\dot{m}_{port}}{\dot{m}_{thresh}}\right)}{2}.$$

The negative mass flow direction is defined as:

$$\dot{m}_{port}^- = \frac{1 - \tanh\left(\frac{4\dot{m}_{port}}{\dot{m}_{thresh}}\right)}{2}.$$

The mass flow rate threshold, which is the point at which the flow in the pipe begins to reverse direction, is calculated as:

$$\dot{m}_{thresh} = Re_c \nu \bar{\rho} \sqrt{\frac{\pi}{4} A_{min}},$$

where:

- Re_c is the **Critical Reynolds number**, beyond which the transitional flow regime begins.
- ν is the fluid viscosity.
- $\bar{\rho}$ is the average fluid density.
- A_{\min} is the smallest cross-sectional area in the pipe junction.

Momentum Balance

Mass is conserved in the pipe segment:

$$\dot{m}_A + \dot{m}_B + \dot{m}_C = 0.$$

Flow through the pipe junction is calculated from momentum conservation equations between ports **A**, **B**, and **C**:

$$p_A - p_I = \frac{K_A}{2\bar{\rho}A_{\text{main}}^2} \dot{m}_A \sqrt{\dot{m}_A^2 + \dot{m}_{\text{thresh}}^2}$$

$$p_B - p_I = \frac{K_B}{2\bar{\rho}A_{\text{main}}^2} \dot{m}_B \sqrt{\dot{m}_B^2 + \dot{m}_{\text{thresh}}^2}$$

$$p_C - p_I = \frac{K_C}{2\bar{\rho}A_{\text{side}}^2} \dot{m}_C \sqrt{\dot{m}_C^2 + \dot{m}_{\text{thresh}}^2}$$

where A_{main} is the **Main branch area (A-B)** and A_{side} is the **Side branch area (A-C, B-C)**.

Ports

Conserving

A – Liquid port

isothermal liquid

Liquid entry or exit port.

B – Liquid port

isothermal liquid

Liquid entry or exit port.

C – Liquid port

isothermal liquid

Liquid entry or exit port.

Parameters

Main branch area (A-B) – Cross-sectional area between ports A and B

0.01 m² (default) | positive scalar

Area of connecting pipe between ports **A** and **B**.

Side branch area (A-C, B-C) — Cross-sectional area of the side branch

0.01 m² (default) | positive scalar

Area of connecting pipe between ports **A** and **C** and between ports **B** and **C**.

Three-way junction type — Junction loss coefficient type

Standard (default) | Custom

The junction loss coefficient type. Set this parameter to Custom to specify individual diverging and converging loss coefficients for each flow path segment.

Main branch converging loss coefficient — Loss coefficient between A and B for custom junctions

1.12 (default) | positive scalar

Loss coefficient for pressure loss calculations between ports **A** and **B** for converging flow.

Dependencies

To enable this parameter, set **Three-way junction type** to Custom.

Main branch diverging loss coefficient — Loss coefficient between A and B for custom junctions

1.12 (default) | positive scalar

Loss coefficient for pressure loss calculations between ports **A** and **B** for diverging flow.

Dependencies

To enable this parameter, set **Three-way junction type** to Custom.

Side branch converging loss coefficient — Branch loss coefficient for custom junctions

1.12 (default) | positive scalar

Loss coefficient for pressure loss calculations between port **C** and the main line for converging flow.

Dependencies

To enable this parameter, set **Three-way junction type** to Custom.

Side branch diverging loss coefficient — Branch loss coefficient for custom junctions

1.12 (default) | positive scalar

Loss coefficient for pressure loss calculations between port **C** and the main line for diverging flow.

Dependencies

To enable this parameter, set **Three-way junction type** to Custom.

Critical Reynolds number — Upper Reynolds number limit for laminar flow

150 (default) | positive scalar

Upper Reynolds number limit for laminar flow through the junction.

References

[1] Crane Co. *Flow of Fluids Through Valves, Fittings, and Pipe TP-410*. Crane Co., 1981.

See Also

Area Change (IL) | Pipe Bend (IL) | Elbow (IL) | Local Resistance (IL)

Introduced in R2020a

Tank

Pressurized fluid container with variable fluid level

Library: Simscape / Fluids / Hydraulics (Isothermal) / Low-Pressure Blocks

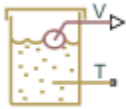

Description

The Tank block models a pressurized fluid container with a variable fluid level. The tank has an optional number of ports ranging from one to three, with each number corresponding to a block variant. The tank pressurization is fixed regardless of changes to fluid volume or fluid level. The tank is vented if the pressurization is set to zero—a setting corresponding to an internal pressure equal to atmospheric pressure.

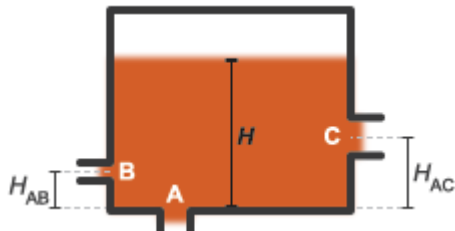

Tank Ports and Port Elevations

The block accounts for differences in port elevation. Hydrostatic pressure is computed separately for each port from the fluid level and port elevation. The hydrostatic pressure adds to the pressurization of the tank—increasing the port pressure as the fluid level rises. The block accounts also for minor pressure losses at the ports due to filters, fittings, and other local flow resistances. To modulate these losses, the block provides a pressure loss coefficient for each port.

Changing the Number of Ports

To change the number of ports in the tank, you must change the active block variant. You can do this from the context-sensitive menu of the block. Right-click the block to open the menu and select **Simscape > Block choices** to view or change the active block variant. Variant options include:

- **One inlet** (default) — Exposes one hydraulic conserving port, **T**.
- **Two inlets** — Exposes hydraulic conserving ports **A** and **B**.
- **Three inlets** — Exposes hydraulic conserving ports **A**, **B**, and **C**.

Port **A** in the **Two inlets** and **Three inlets** variants is a direct replacement of port **T** in the **One inlet** variant.

Port Depth and Fluid Level

Port **T** in the **One inlet** variant—or port **A**, its replacement in the **Two inlets** and **Three inlets** variants—is by default located at the bottom of the tank. The depth of this port relative to the top of the fluid volume is equal to the fluid level—the height of the fluid volume:

$$y_{T/A} = H,$$

where:

- $y_{T/A}$ is the depth of port **T** or **A**.
- H is the fluid level in the tank.

Ports **B** and **C** in the **Two inlets** and **Three inlets** variants are assumed to be located above port **A**. The depths of these ports are each computed as the difference between the fluid level and the port elevation above port **A**:

$$y_B = H - H_{AB},$$

and

$$y_C = H - H_{AC},$$

where:

- y_B and y_C are the depths of ports **B**, and **C**.
- H_{AB} and H_{AC} are the elevations of ports **B** and **C** above port **A**.

The fluid level, H , is computed during simulation from the instantaneous fluid volume. This calculation depends on the **Tank volume parameterization** setting. If the parameterization is set to **Constant cross-sectional area** (the default setting), the fluid level is:

$$H = \frac{V}{S},$$

where:

- V is the instantaneous fluid volume in the tank.
- S is the internal cross-sectional area of the tank, specified in the **Tank cross-section area** parameter.

If the **Tank volume parameterization** is set to **Tabulated data – Volume vs. level**, the fluid level is computed by interpolation or extrapolation of tabulated fluid level data specified as a function of fluid volume:

$$H = f(V)$$

The instantaneous fluid volume varies with the volumetric flow rates through the exposed ports. This volume increases if the sum of all flow rates is positive. A flow rate is positive if it is directed from the port to the interior of the tank, that is, if fluid enters the tank. The time rate of change of the fluid volume is defined as:

$$\frac{dV}{dt} = \sum_i q_i,$$

where q_i is the flow rate into the tank through the port denoted by i —**T/A**, **B**, or **C**.

Flow Rate and Pressure Drop

The volumetric flow rate through a port is a function of the pressure drop from that port to the interior of the tank. The flow rate is positive if the pressure drop is positive—that is, if pressure is higher at the port than in the tank—and negative otherwise:

$$q_i = A_i \sqrt{\frac{2}{K_i \rho}} \frac{\Delta p_i}{(\Delta p_i^2 + p_{Cr,i}^2)^{1/4}},$$

where:

- A_i is the internal cross-sectional area of the port denoted by i (**T/A**, **B**, or **C**):

$$A_i = \frac{\pi d_i^2}{4},$$

with d_i as the internal diameter of the port.

- K_i is the pressure loss coefficient specified for the port.
- ρ is the hydraulic fluid density.
- Δp_i is the pressure drop from the port to the interior of the tank.
- $p_{Cr,i}$ is the critical pressure at which the flow through the port switches between laminar and turbulent.

The critical pressure at a port is computed from the critical Reynolds number, internally set to a value of 15, and from the respective port diameter. The critical pressure is modulated by the pressure loss coefficient specified for the port—with this parameter serving as a gain for the critical pressure:

$$p_{Cr,i} = K_i \frac{\rho}{2} \left(\frac{Re_{Cr} \nu}{d_i} \right),$$

where:

- Re_{Cr} is the critical Reynolds number.
- ν (nu) is the hydraulic fluid dynamic viscosity.
- d_i is the internal diameter of the port denoted by i .

The pressure drop from a port to the interior of the tank is computed from the specified **Pressurization** value, the hydrostatic pressure, and the pressure at the port:

$$\Delta p_i = p_{port,i} - (p_{press} + p_{elev,i}),$$

where:

- $p_{port,i}$ is the pressure at the port denoted by i .
- p_{press} is the specified tank **Pressurization** value.
- $p_{elev,i}$ is the hydrostatic pressure at the port.

The hydrostatic pressure at a port is a function of the port elevation above the bottom of the tank (zero for port **T/A**):

$$p_{elev,i} = \rho g y_i$$

where

- g is the value of the gravitational acceleration at the mean elevation of the system.
- y_i is the elevation of the port denoted by i relative to the bottom of the port.

C/C++ Code Generation

This block supports code generation for real-time simulation tasks. Certain blocks and block settings may be more suitable for simulation on a real-time device. For suggestions on how to improve real-time simulation performance, use the Simulink `performanceadvisor` function. Suggestions include ways to reduce model complexity and decrease numerical stiffness.

In the Simulink Editor, click the **Debug** tab and select **Performance Advisor** from **Performance Advisor**. Set the **Activity** parameter to `Execute real-time application` to view suggestions specific to real-time simulation performance. Expand the **Real-Time** node in the tree view pane to select performance checks specific to Simscape products.

Ports

Output

V — Fluid volume, m³

physical signal

Physical signal output port reporting the volume of fluid in the tank.

Conserving

T — Tank inlet

hydraulic (isothermal liquid)

Hydraulic (isothermal liquid) conserving port representing the tank inlet.

Dependencies

This port is active when the block variant is in the default setting of `One inlet`. You can change block variants from the block context-sensitive menu. Right-click the block to open the menu and select **Simscape > Block choices**.

A — Tank inlet

hydraulic (isothermal liquid)

Hydraulic (isothermal liquid) conserving port representing one of multiple tank inlets.

Dependencies

This port is active when the block variant is set to `Two inlets` or `Three inlets`. You can change block variants from the block context-sensitive menu. Right-click the block to open the menu and select **Simscape > Block choices**.

B — Tank inlet

hydraulic (isothermal liquid)

Hydraulic (isothermal liquid) conserving port representing one of multiple tank inlets.

Dependencies

This port is active when the block variant is set to `Two inlets` or `Three inlets`. You can change block variants from the block context-sensitive menu. Right-click the block to open the menu and select **Simscape > Block choices**.

C — Tank inlet

hydraulic (isothermal liquid)

Hydraulic (isothermal liquid) conserving port representing one of multiple tank inlets.

Dependencies

This port is active when the block variant is set to `Three inlets`. You can change block variants from the block context-sensitive menu. Right-click the block to open the menu and select **Simscape > Block choices**.

Parameters

Parameters Tab

Pressurization — Gauge pressure of the tank volume

0 Pa (default) | scalar number in units of pressure

Gauge pressure of the tank volume. The tank pressure is held constant at this value during simulation. The default value, 0 Pa, corresponds to a vented tank—one whose internal pressure is equal to the atmospheric pressure of the system.

Tank volume parameterization — Choice of parameterization for the tank volume

Constant cross-sectional area (default) | Tabulated data — volume vs. level

Choice of parameterization for the tank volume. Select `Constant cross-sectional area` to compute the tank volume from the variable fluid level and a constant cross-sectional area. Select `Tabulated data — volume vs. level` to compute the tank volume by interpolation or extrapolation of tabulated data on the fluid volume at discrete fluid levels.

Tank cross-section area — Area of the (constant) tank cross-section

0.8 m² (default) | scalar number in units of area

Area of the tank cross-section, assumed constant over the allowed range of fluid levels. The block uses this parameter to compute the volume of fluid inside the tank.

Fluid volume vector — Fluid volumes at which to specify the tank fluid levels

16-element row vector with values ranging from 0 to 0.727 m³ (default) | N-element vector with elements in units of volume

Array of fluid volumes for the 1-D lookup table used to compute the tank fluid level. The array must increase from left to right but the intervals between the array element values need not be uniform. There must be at least two elements for `Linear interpolation` and three elements for `Smooth interpolation`.

Dependencies

This parameter is active when the **Tank volume parameterization** parameter is set to `Tabulated data — volume vs. level`.

Fluid level vector – Fluid levels corresponding to the specified fluid volumes

16-element row vector with values ranging from 0 to 0.3 m (default) | N -element vector with elements in units of length

Array of fluid levels corresponding to the specified orifice openings. The number of elements in the array must match the number of elements in the **Opening vector** parameter.

Dependencies

This parameter is active when the **Tank volume parameterization** parameter is set to Tabulated data – volume vs. level.

Interpolation method – Method of computing values inside the lookup table range

Linear (default) | Smooth

Method of computing values inside the tabulated data range. The Linear method joins adjacent data points with straight line or surface segments with generally discontinuous slope at the segment boundaries. Surface segments are used in the 2-D lookup table specified in the Pressure-flow characteristic model parameterization.

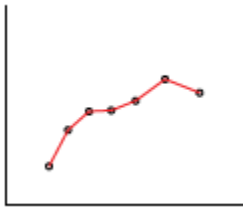

The Smooth method replaces the straight segments with curved versions that have continuous slope everywhere inside the tabulated data range. The segments form a smooth line or surface passing through all of the tabulated data points without the discontinuities in first-order derivatives characteristic of the Linear interpolation method.

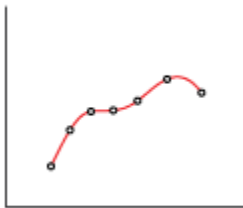
**Dependencies**

This parameter is active when the **Tank volume parameterization** parameter is set to Tabulated data – Volume vs. level.

Extrapolation method – Method of computing values outside of the lookup table range

Linear (default) | Nearest

Method of computing values outside of the tabulated data range. The Linear method extends the line segment drawn between the last two data points at each end of the data range outward with a constant slope.



The **Nearest** method extends the last data point at each end of the data range outward as a horizontal line with constant value.

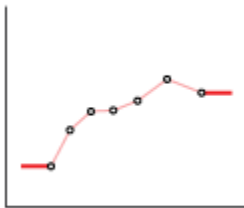

Dependencies

This parameter is active when the **Tank volume parameterization** parameter is set to **Tabulated data – Volume vs. level**.

Inlet pipeline diameter – Diameter of the tank inlet

0.02 m (default) | scalar number in units of length

Diameter of the tank inlet. The tank has a single port when this parameter is exposed.

Dependencies

This parameter is active when the block variant is set to **One inlet**.

Port A/B/C pipeline diameter – Diameter of tank port A/B/C

0.02 m (default) | scalar number in units of length

Diameter of tank port **A/B/C**.

Dependencies

This parameter is active when the block variant is set to **Two inlets** or **Three inlets**.

Pipeline pressure loss coefficient – Coefficient used to account for pressure loss at the inlet

1.2 (default) | unitless scalar number

Empirical coefficient used to account for pressure losses at the tank inlet. This parameter must be greater than zero. The block has a single port when this parameter is exposed.

Dependencies

This parameter is active when the block variant is set to **One inlet**.

Port A/B/C pressure loss coefficient – Coefficient used to account for pressure loss at port A/BC

1.2 (default) | unitless scalar number

Empirical coefficient used to account for pressure losses at port A/B/C. This parameter must be greater than zero.

Dependencies

This parameter is active when the block variant is set to Two inlets or Three inlets.

Port B/C height above port A – Elevation of port B/C above port A

0.8 m (default) | scalar number in units of length

Elevation of port B/C above port A. The block uses this parameter to account for differences in port elevation.

Dependencies

This parameter is active when the block variant is set to Two inlets or Three inlets.

Acceleration due to gravity – Gravitational acceleration constant9.80665 m/s² (default) | scalar number in units of acceleration

Gravitational acceleration constant at the mean elevation of the hydraulic system. Changes in gravitational acceleration are assumed negligible over the height of the system.

Minimum level of fluid – Lowest fluid level allowed during simulation

1e-3 m (default) | scalar number in units of length

Lowest fluid level allowed during simulation. The block triggers a simulation warning if the fluid level falls below the specified value.

Check if fluid level violating minimum valid condition – Simulation warning mode for minimum valid fluid level

None (default) | Warning

Simulation warning mode for invalid fluid levels in the tank. Select Warning to be notified when the fluid level falls below a minimum specified value.

Variables Tab**Fluid volume – Volume of fluid in the tank at time zero**

20 L (default) | scalar number in units of volume

Volume of fluid in the tank at time zero. Simscape software uses this parameter to guide the initial configuration of the component and model. Initial variables that conflict with each other or are incompatible with the model may be ignored. Set the **Priority** column to High to prioritize this variable over other, low-priority, variables.

Fluid level – Height of fluid volume at time zero

0.025 m (default) | scalar number in units of length

Height of the fluid volume in the tank at time zero. Simscape software uses this parameter to guide the initial configuration of the component and model. Initial variables that conflict with each other or are incompatible with the model may be ignored. Set the **Priority** column to High to prioritize this variable over other, low-priority, variables.

Extended Capabilities

C/C++ Code Generation

Generate C and C++ code using Simulink® Coder™.

See Also

Constant Head Tank | Reservoir

Topics

“Upgrading Simscape Fluids Models Containing Hydraulics (Isothermal) Blocks”

Tank (IL)

Tank in an isothermal liquid system

Library: Simscape / Fluids / Isothermal Liquid / Tanks & Accumulators

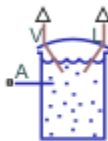

Description

The Tank (IL) block models a container with up to six input ports, **A** through **F**, within an isothermal liquid system. The tank outputs fluid volume at port **V** and fluid level at port **L** as physical signals. The block models the hydrostatic pressure difference between the liquid surface and the inlet height level. The tank can be pressurized to a constant, user-specified value or to atmospheric pressure.

Fluid Volume

The volume of fluid in the tank is determined from the total mass flow into the tank:

$$V = \frac{M}{\rho},$$

where:

- M is the total mass in the tank supplied by all ports.
- ρ is the fluid density.

Due to the constant pressure in the tank, the liquid volume inside the tank changes based on mass flow rate. Note that the converse is true for pipes, where pressure is a function of fixed fluid volumes.

If the tank fluid volume exceeds the specified capacity of the tank, you can choose to be notified. Set the **Liquid volume above max capacity** parameter to **Warning** if you would like to receive a warning when this occurs during simulation. Set the parameter to **Error** if you would like the simulation to stop when this occurs.

Fluid Level

If **Tank volume parameterization** is set to **Constant cross-section area**, the fluid level in the tank is determined from the fluid volume V , due to the constant cross-sectional area of the tank. Otherwise, the fluid level can be specified as tabulated data in the **Tabulated data - volume vs. level** option.

When the level in the tank falls below the inlet height, the assumption that fluid entirely fills the volume of the connecting blocks may not be valid. Connections to a Pipe (IL) block, which is based on this assumption, may in this case return unphysical results. If you expect to model tank fluid levels below tank inlet height(s), connect the Tank (IL) block to your system with a Partially Filled Pipe (IL) block instead.

Like the **Liquid volume above max capacity** parameter, you can be notified if the tank fluid level falls below the height of the inlet port(s) during your simulation by changing the **Liquid level below inlet height** parameter setting.

Mass Flow Rate

If you have more than one port enabled, the equations below apply to each port. The mass flow rate at the inlet port is:

$$\dot{m}_{port} = A_{port} \frac{\sqrt{2\rho} \Delta p_{port}}{\sqrt{\zeta} [\Delta p_{port}^2 + \Delta p_{port,crit}^2]^{1/4}},$$

where:

- A_{port} is the **Inlet cross-sectional area**.
- ρ is the fluid density.
- ζ is the **Inlet pressure loss coefficient**.

The inlet pressure difference due to inlet losses is:

$$\Delta p_{port} = p_{port} - (P + \Delta p_{elev, port}),$$

where:

- p_{port} is the pressure at the inlet port.
- P is the **Tank pressurization** if the **Pressurization specification** parameter is set to **Specified pressure**. Otherwise, P is the atmospheric pressure.
- $\Delta p_{elev, port}$ is the hydrostatic pressure difference at the specified port **Inlet height**:
 $\Delta p_{elev, port} = \rho g L$, where L is either the difference in height between the fluid level and the inlet height or zero, whichever is larger.

The critical pressure difference, Δp_{crit} , is the pressure differential associated with the *critical Reynolds number*, Re_{crit} , which is the point of transition between laminar and turbulent flow in the fluid:

$$\Delta p_{crit} = \frac{\pi \rho P R_{loss}}{8 A_{port}} (\nu Re_{crit})^2,$$

where ν is the fluid kinematic viscosity.

Variables

Use the **Variables** tab to set the priority and initial target values for the block variables prior to simulation. For more information, see “Set Priority and Initial Target for Block Variables”.

Ports

Conserving

A – Liquid port

isothermal liquid

Tank inlet.

B – Liquid port

isothermal liquid

Optional tank inlet.

DependenciesTo enable this port, set **Number of inlets** to 2, 3, 4, 5, or 6.**C – Liquid port**

isothermal liquid

Optional tank inlet.

DependenciesTo enable this port, set **Number of inlets** to 3, 4, 5, or 6.**D – Liquid port**

isothermal liquid

Optional tank inlet.

DependenciesTo enable this port, set **Number of inlets** to 4, 5, or 6.**E – Liquid port**

isothermal liquid

Optional tank inlet.

DependenciesTo enable this port, set **Number of inlets** to 5 or 6.**F – Liquid port**

isothermal liquid

Optional tank inlet.

DependenciesTo enable this port, set **Number of inlets** to 6.**Output****V – Liquid volume, m³**

physical signal

Liquid volume inside the tank in m³, specified as a physical signal.**L – Liquid level, m**

physical signal

Liquid level inside the tank in m, specified as a physical signal.

Parameters

Number of inlets — Number of inlet ports

1 (default) | positive integer between 1 and 6

Number of inlet ports. Setting this parameter to 2 or more exposes additional input ports.

Pressurization specification — Tank pressure

Atmospheric pressure (default) | Specified pressure

Specifies a constant tank pressure. You can define a non-atmospheric pressure by selecting Specified pressure and defining the value in **Tank pressurization**.

Tank pressurization — User-defined tank pressure

0.101325 MPa (default) | positive scalar

User-defined tank pressure.

Tank volume parameterization — Tank area characteristics

Constant cross-section area (default) | Tabulated data - volume vs. level

Specifies tank area characteristics. This parameter is used to determine the fluid level in the tank. If you would like to model a tank with a variable cross-sectional area, you can provide data for tank volume and fluid level in the Tabulated data - volume vs. level option.

Tank cross-sectional area — Tank cross-sectional area

1 m² (default) | positive scalar

Tank cross-sectional area.

Dependencies

To enable this parameter, set **Tank volume parameterization** to Constant cross-section area.

Liquid level vector — Vector of tank fluid levels

[0, 3, 5] m (default) | 1-by-*n* vector

Vector of tank fluid levels for the tabular parameterization of a non-constant tank area. The values in this vector correspond one-to-one to values in the **Volumetric flow rate vector** parameter. Its elements are listed in ascending order. The elements must be positive and the first element must be 0.

Dependencies

To enable this parameter, set **Tank volume parameterization** to Tabulated data - volume vs. level.

Liquid volume vector — Vector of tank fluid volumes

[0, 4, 6] m³ (default) | 1-by-*n* vector

Vector of tank fluid volumes for the tabular parameterization of a non-constant tank area. The values in this vector correspond one-to-one to values in the **Liquid level vector** parameter. Its elements are listed in ascending order. The elements must be positive and the first element must be 0.

Dependencies

To enable this parameter, set **Tank volume parameterization** to Tabulated data - volume vs. level.

Inlet height — Height of inlet port

0.1 m (default) | positive scalar

Height of inlet port. The value must be greater than or equal to 0.

Dependencies

To enable this parameter, set **Number of inlets** to 1.

Inlet cross-sectional area — Cross-sectional area of the port inlet

0.01 m² (default) | positive scalar

Cross-sectional area of the port inlet. This value must be greater than 0.

Inlet pressure loss coefficient — Loss coefficient for pressure at inlet port

1.2 (default) | positive scalar

Loss coefficient for pressure at inlet port. This value is used for calculating the hydrostatic pressure at the inlet and determining the fluid level minimum conditions.

Height vector for inlets A and B — Vector of port heights for multiple enabled ports

[.1, 0] (default) | 1-by-*n* vector

Vector of port heights for multiple enabled ports. If you have two or more ports enabled, the **Inlet height** parameter becomes a vector of values that correspond to the height of each inlet port, starting with port **A**. The parameter name will include all enabled ports. Each element of this vector must be greater than or equal to 0.

Dependencies

To enable this parameter, set **Number of inlets** to 2, 3, 4, 5, or 6.

Cross-sectional area vector for inlets A and B — Vector of inlet areas for two enabled ports

[.01, .01] m² (default) | 1-by-*n* vector

Vector of cross-sectional areas for multiple enabled ports. If you have two or more ports enabled, the **Inlet cross-sectional area** parameter becomes a vector of values that correspond to the cross-sectional area of each inlet, starting with port **A**. The parameter name will include all enabled ports. Each element of this vector must be greater than 0.

Dependencies

To enable this parameter, set **Number of inlets** to 2, 3, 4, 5, or 6.

Pressure loss coefficient vector for inlets A and B — Vector of pressure loss coefficients for tank inlets

[1.2, 1.2] (default) | 1-by-*n* vector

Vector of pressure loss coefficients for multiple enabled ports. If you have two or more ports enabled, the **Pressure loss coefficient** parameter becomes a vector of values corresponding to the loss

coefficient for each inlet port, starting with port **A**. The parameter name will include all enabled ports. Each element of this vector must be greater than 0.

Dependencies

To enable this parameter, set **Number of inlets** to 2, 3, 4, 5, or 6.

Liquid level below inlet height — Whether to be notified of low tank levels

Error (default) | None | Warning

Whether to be notified if the tank fluid level falls below the port inlet height during simulation. Set this parameter to **Warning** if you would like to receive a warning when this occurs during simulation. Set the parameter to **Error** if you would like the simulation to stop when this occurs.

Liquid volume above max capacity — Whether to be notified of high tank volume

None (default) | Warning | Error

Whether to be notified if the tank fluid volume rises above the tank maximum capacity during simulation. Set this parameter to **Warning** if you would like to receive a warning when this occurs during simulation. Set the parameter to **Error** if you would like the simulation to stop when this occurs.

Maximum tank capacity — Fill limit of the tank

10 m³ (default) | positive scalar

Fill limit of the tank.

Dependencies

To enable this parameter, set **Liquid volume above max capacity** to either:

- Warning
- Error

Gravitational acceleration — Acceleration of gravity constant

9.81 m/s² (default) | positive scalar

Constant for the acceleration of gravity.

See Also

Partially Filled Pipe (IL) | Partially Filled Vertical Pipe LP | Gas-Charged Accumulator (IL) | Spring-Loaded Accumulator (IL)

Introduced in R2020a

Tank (G-TL)

Pressurized tank with variable gas and thermal liquid volumes

Library: Simscape / Fluids / Fluid Network Interfaces / Tanks & Accumulators

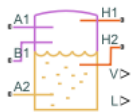

Description

The Tank (G-TL) block models the accumulation of mass and energy in a chamber with separate gas and thermal liquid volumes. The total fluid volume is fixed but the individual gas and thermal liquid volumes are free to vary. Two gas ports allow for gas flow and a variable number of thermal liquid ports, ranging from one to three, allow for thermal liquid flow. The thermal liquid ports can be at different elevations.

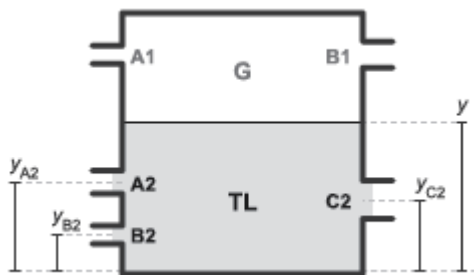

Tank Inlets and Inlet Heights (y)

The tank is pressurized but the pressurization is not fixed. It changes during simulation with the pressure in the gas volume. It rises when the pressure of the gas volume rises and it falls when the pressure of the gas volume falls. The thermal liquid volume is assumed to be at equilibrium with the gas volume and its pressure is therefore the same as that of the gas.

The fluid volumes can exchange energy with other fluid components and with the environment but not with each other. The fluid volumes behave as if they were isolated from each other by an insulated membrane. Energy exchanges with other components occur through gas or thermal liquid ports, while exchanges with the environment occur, strictly in the form of heat, through thermal ports.

Use this block to model components such as drain tanks, in which water condensed from a compressed gas system is trapped at the bottom by gravity and expelled through a drain outlet. Note, however, that neither gas nor thermal liquid domains capture the effects of phase change—and therefore that this block cannot capture the effects of condensation.

Inlet Variants

The number of thermal liquid ports depends on the block variant that is active. To view or change the active variant, right-click the block and select **Simscape > Block Choices**. The **One inlet** variant exposes thermal liquid port **A2**, the **Two inlets** variant adds port **B2**, and the **Three inlets** variant adds port **C2**.

Fluid Volumes

The total volume of the tank is equal to the sum of the gas and thermal liquid volumes that it contains:

$$V_T = V_L + V_G,$$

where V is volume and T, L, and G stand for *total*, *liquid*, and *gas*. Because the total volume is fixed, the time rate of change of the gas volume must be the reverse of that measured for the thermal liquid volume:

$$\dot{V}_G = -\dot{V}_L.$$

The time rate of change of the thermal liquid volume is calculated by differentiating the expression:

$$M_L = \rho_L V_L,$$

where M is mass and ρ is density. The differentiation gives the mass flow rate into the thermal liquid volume:

$$\dot{M}_L = V_L \dot{\rho}_L + \dot{V}_L \rho_L,$$

The time rate of change of the thermal liquid density is:

$$\dot{\rho}_L = \frac{\rho_L}{\beta_L} \dot{p}_L - \alpha_L \rho_L \dot{T}_L,$$

where:

- β is the isothermal bulk modulus.
- α is the isobaric thermal expansion coefficient.
- p is the fluid pressure.
- T is the fluid temperature.

Rearranging terms gives the rate of change of the thermal liquid volume and, by extension, of the gas volume:

$$\dot{V}_G = -\dot{V}_L \approx V_L \left(\frac{\dot{p}_L}{\beta_L} - \alpha_L \dot{T}_L \right) - \frac{\dot{M}_L}{\rho_L}$$

Mass Balance

The rate of mass accumulation in each fluid volume is equal to the net mass flow rate into that fluid volume. In the thermal liquid volume:

$$\dot{M}_L = \sum_{i=A2, B2, C2} \dot{m}_i,$$

where \dot{M}_L is the rate of mass accumulation in the thermal liquid volume and \dot{m}_i are the individual mass flow rates into that volume through the thermal liquid ports (**A2**, **B2**, and **C2** in the case of the Three inlets variant). The rate of mass accumulation contains contributions from pressure, temperature, and volume change:

$$\dot{M}_L = V_L \left(\frac{\rho_L}{\beta_L} \dot{p}_G - \alpha_L \rho_L \dot{T}_L \right) + \dot{V}_L \rho_L,$$

where the pressure of the thermal liquid volume is by definition equal to the pressure of the gas volume and the equation is therefore written in terms of the gas pressure. In the gas volume:

$$\dot{M}_G = \sum_{i = A1, B1} \dot{m}_i,$$

where M_G is the rate of mass accumulation in the gas volume and \dot{m}_i are the individual mass flow rates into that volume through the gas ports (**A2** and **B2**). As with the thermal liquid volume, the rate of mass accumulation contains contributions from pressure, temperature, and volume change:

$$\dot{M}_G = \left. \frac{dM}{dp} \right|_G \dot{p}_G + \left. \frac{dM}{dT} \right|_G \dot{T}_G + \dot{V}_G \rho_G,$$

where the pressure and temperature derivatives depend on the type of gas specified in the Gas Properties (G) block. The derivatives are defined in the equations section of the Translational Mechanical Converter (G) block reference page. Replacing V_G with the expression previously obtained for this variable and combining the two expressions for M_G :

$$\left. \frac{dM}{dp} \right|_G \dot{p}_G + \left. \frac{dM}{dT} \right|_G \dot{T}_G + \left[V_L \left(\frac{\dot{p}_G}{\beta_L} - \alpha_L \dot{T}_L \right) - \frac{\dot{M}_L}{\rho_L} \right] \rho_G = \sum_{i = A1, B1} \dot{m}_i.$$

Rearranging terms gives the final expression for the mass balance in the gas volume:

$$\dot{p}_G \left(\left. \frac{dM}{dp} \right|_G + \frac{\rho_G V_L}{\beta_L} \right) + \left(\dot{T}_G \left. \frac{dM}{dT} \right|_G - \dot{T}_L \rho_G V_L \alpha_L \right) = \sum_{i = A1, B1} \dot{m}_i + \frac{\rho_G}{\rho_L} \sum_{i = A2, B2, C2} \dot{m}_i,$$

where \dot{M}_L has been replaced with the summation of the mass flow rates into the thermal liquid volume.

Energy Balance

The rate of energy accumulation in each fluid volume is the sum of the energy flow rates through the fluid inlets, the heat flow rate through the corresponding thermal port, and the energy flow rate due to volume changes. For the gas volume:

$$\dot{p}_G \left(\left. \frac{dU}{dp} \right|_G + \rho_G h_G \frac{V_L}{\beta_L} \right) + \left(\dot{T}_G \left. \frac{dU}{dT} \right|_G - \dot{T}_L \rho_G h_G V_L \alpha_L \right) = Q_{H1} + \sum_{i = A1, B1} \phi_i + \frac{\rho_G}{\rho_L} h_G \sum_{i = A2, B2, C2} \dot{m}_i,$$

where:

- U is the total energy of the fluid volume.
- h is the fluid enthalpy.
- Q is the heat flow rate through the thermal port.
- ϕ_i are the energy flow rates through the fluid inlets.

As before, the pressure and temperature derivatives depend on the type of gas specified in the Gas Properties (G) block. See the equations section of the Translational Mechanical Converter (G) block reference page for their definitions. For the thermal liquid volume:

$$\dot{p}_L \left. \frac{dU}{dp} \right|_L + \dot{T}_L \left. \frac{dU}{dT} \right|_L = Q_{H2} + \sum_{i = A2, B2, C2} \phi_i + \sum_{i = A2, B2, C2} \dot{m}_i g(y(i) - y) - h_L \sum_{i = A2, B2, C2} \dot{m}_i,$$

where the pressure derivative is:

$$\left. \frac{dU}{dp} \right|_L = -T_L \alpha_L V_L,$$

and the temperature derivative is:

$$\left. \frac{dU}{dT} \right|_L = c_{p,L} \rho_L V_L,$$

in which c_p is the isobaric specific heat of the thermal liquid inside the tank.

Momentum Balance

Flow resistance due to friction or other causes is ignored in both fluid volumes. The effect of elevation on inlet pressure is also ignored, but only on the gas side. The gas inlet pressures are therefore equal to each other and to the internal pressure of the gas volume:

$$p_{A1} = p_{B1} = p_G.$$

The thermal liquid inlet pressures are each a function of inlet depth. The internal pressure of the thermal liquid volume is equal to that of the gas volume ($p_L = p_G$). Including the dynamic pressures ($p_{i,dyn}$) at the inlets:

$$p_i + p_{i,dyn} = p_G + \rho_L (y - y_i) g,$$

where y is the elevation of the thermal liquid surface, y_i is the elevation of the thermal liquid inlet, and g is the gravitational constant. The term $(y - y_i)$ gives the depth of the thermal liquid inlet with respect to the gas-thermal liquid boundary. The dynamic pressure at each thermal liquid inlet depends on the direction of flow at that inlet:

$$p_{i,dyn} = \begin{cases} \frac{1}{2} \rho_i v_i^2, & \text{if } \dot{m}_i < 0 \\ 0, & \text{if } \dot{m}_i \geq 0 \end{cases}$$

Ports

Output

V — Thermal liquid volume, m³

physical signal

Physical signal output port reporting the volume of thermal liquid in the tank.

L — Thermal liquid level, m

physical signal

Physical signal output port reporting the height of the thermal liquid volume relative to the bottom of the tank.

Conserving

A1 — Gas inlet

gas

Opening through which gas can flow into or out of the tank.

B1 – Gas inlet

gas

Opening through which gas can flow into or out of the tank.

A2 – Thermal liquid inlet

thermal liquid

Opening through which thermal liquid can flow into or out of the tank.

B2 – Thermal liquid inlet

thermal liquid

Opening through which thermal liquid can flow into or out of the tank.

Dependencies

This port is active when the block variant is set to `Two inlets` or `Three inlets`. You can change block variants from the block context-sensitive menu. Right-click the block to open the menu and select **Simscape > Block choices**.

C2 – Thermal liquid inlet

thermal liquid

Opening through which thermal liquid can flow into or out of the tank.

Dependencies

This port is active when the block variant is set to `Three inlets`. You can change block variants from the block context-sensitive menu. Right-click the block to open the menu and select **Simscape > Block choices**.

Parameters**Parameters Tab****Total tank volume – Combined gas and thermal liquid volume**10 m³ (default) | positive scalar with units of volume

Aggregate volume of the gas and thermal liquid portions of the tank.

Tank volume parameterization – Choice of parameterization for the thermal liquid volume

Constant cross-sectional area (default) | Tabulated data – volume vs. level

Choice of parameterization for the thermal liquid volume. Select `Tabulated data – volume vs. level` to compute the thermal liquid volume by interpolation or extrapolation of tabulated data.

Tank cross-sectional area – Area of the (constant) tank cross-section1 m² (default) | scalar number in units of area

Area of the tank cross-section, assumed constant over the allowed range of fluid levels. The block uses this parameter to compute the volume of thermal liquid inside the tank.

Liquid level vector – Thermal liquid levels at which to specify the thermal liquid volume

[0, 3, 5] m (default) | scalar number in units of length

Vector of thermal liquid levels at which to specify the thermal liquid volume in the tank. The block uses this vector to construct a one-way lookup table for the thermal liquid volume as a function of the thermal liquid level.

Dependencies

This parameter is active when the **Tank volume parameterization** parameter is set to Tabulated data - volume vs. level.

Liquid volume vector – Thermal liquid volume corresponding to the specified thermal liquid levels

[0, 4, 6] m³ (default) | scalar number in units of volume

Vector of thermal liquid volumes corresponding to the values specified in the **Liquid level vector** parameter. The block uses this vector to construct a one-way lookup table for the thermal liquid volume as a function of the thermal liquid level.

Dependencies

This parameter is active when the **Tank volume parameterization** parameter is set to Tabulated data - volume vs. level.

Inlet height at port A2 – Height of the thermal liquid inlet

0.1 m (default) | positive scalar with units of length

Height of the thermal liquid inlet.

Dependencies

This parameter is active when the block variant is set to One inlet.

Height vector for inlets A2 and B2 – Heights of the thermal liquid inlets

[.1, 0] m (default) | vector with number of elements equal to the number of thermal liquid ports

Vector of heights of the thermal liquid ports relative to the bottom of the tank.

Dependencies

This parameter is active when the block variant is set to Two inlets.

Height vector for inlets A2, B2, and C2 – Heights of the thermal liquid inlets

[.1, 0.5, 0] m (default) | vector with number of elements equal to the number of thermal liquid ports

Vector of heights of the thermal liquid ports relative to the bottom of the tank.

Dependencies

This parameter is active when the block variant is set to Three inlets.

Cross-sectional area vector for inlets A1 and B1 – Flow areas of the gas inlets

[.01, .01] m² (default) | vector with two elements

Vector with flow areas of the gas inlets.

Cross-sectional area at port A2 — Flow area of the thermal liquid inlet

0.01 m² (default) | positive scalar with units of area

Flow area of the thermal liquid inlet.

Dependencies

This parameter is active when the block variant is set to One inlet.

Cross-sectional area vector for inlets A2 and B2 — Flow areas of the thermal liquid inlets

[0.01, 0.01] m² (default) | vector with number of elements equal to the number of thermal liquid ports

Flow areas of the thermal liquid inlets.

Dependencies

This parameter is active when the block variant is set to Two inlets.

Cross-sectional area vector for inlets A2, B2, and C2 — Flow areas of the thermal liquid inlets

[0.01, 0.01, 0.01] m² (default) | vector with number of elements equal to the number of thermal liquid ports

Flow areas of the thermal liquid inlets.

Dependencies

This parameter is active when the block variant is set to Three inlets.

Gravitational acceleration — Gravitational acceleration constant

9.81 m/s² (default) | scalar number with units of length/time²

Value of the gravitational acceleration at the elevation of the tank. This constant is assumed constant over the height of the tank.

Variables Tab**Pressure of gas volume — Pressure of the gas volume at time zero**

0.101325 MPa (default) | scalar number with units of pressure

Pressure of the gas volume at time zero. Simscape software uses this parameter to guide the initial configuration of the component and model. Initial variables that conflict with each other or are incompatible with the model may be ignored. Set the **Priority** column to High to prioritize this variable over other, low-priority, variables.

Temperature of gas volume — Temperature of the gas volume at time zero

293.15 K (default) | scalar number with units of temperature

Temperature of the gas volume at time zero. Simscape software uses this parameter to guide the initial configuration of the component and model. Initial variables that conflict with each other or are incompatible with the model may be ignored. Set the **Priority** column to High to prioritize this variable over other, low-priority, variables.

Density of gas volume — Density of the gas volume at time zero

1.2 kg/m³ (default) | scalar number with units of mass/volume

Density of the gas volume at time zero. Simscape software uses this parameter to guide the initial configuration of the component and model. Initial variables that conflict with each other or are incompatible with the model may be ignored. Set the **Priority** column to High to prioritize this variable over other, low-priority, variables.

Temperature of liquid volume — Temperature of the liquid volume at time zero

293.15 K (default) | scalar number with units of temperature

Temperature of the thermal liquid volume at time zero. Simscape software uses this parameter to guide the initial configuration of the component and model. Initial variables that conflict with each other or are incompatible with the model may be ignored. Set the **Priority** column to High to prioritize this variable over other, low-priority, variables.

Liquid level — Height of fluid volume at time zero

5 m (default) | scalar number in units of length

Height of the fluid volume in the tank at time zero. Simscape software uses this parameter to guide the initial configuration of the component and model. Initial variables that conflict with each other or are incompatible with the model may be ignored. Set the **Priority** column to High to prioritize this variable over other, low-priority, variables.

Volume of liquid — Volume of thermal liquid in the tank at time zero

5 m³ (default) | scalar number in units of volume

Volume of thermal liquid in the tank at time zero. Simscape software uses this parameter to guide the initial configuration of the component and model. Initial variables that conflict with each other or are incompatible with the model may be ignored. Set the **Priority** column to High to prioritize this variable over other, low-priority, variables.

Mass of liquid — Mass of thermal liquid in the tank at time zero

5e+3 kg (default) | scalar number in units of mass

Mass of thermal liquid in the tank at time zero. Simscape software uses this parameter to guide the initial configuration of the component and model. Initial variables that conflict with each other or are incompatible with the model may be ignored. Set the **Priority** column to High to prioritize this variable over other, low-priority, variables.

Extended Capabilities

C/C++ Code Generation

Generate C and C++ code using Simulink® Coder™.

See Also

Tank (TL) | Tank

Introduced in R2017b

Tank (TL)

Thermal liquid container with variable fluid volume

Library: Simscape / Fluids / Thermal Liquid / Tanks & Accumulators

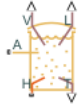

Description

The Tank (TL) block models a thermal liquid container with a variable fluid volume. The absolute pressure of the tank fluid volume is assumed constant and equal to the value specified in the block dialog box. In the special case that the tank pressurization is equal to atmospheric pressure, the block represents a vented tank.

The tank can exchange energy with its surroundings, allowing its internal temperature and pressure to evolve over time. Heat transfer occurs via convection, as liquid enters or exits the chamber, and conduction, as thermal energy flows through the tank walls and the liquid itself at the tank inlets.

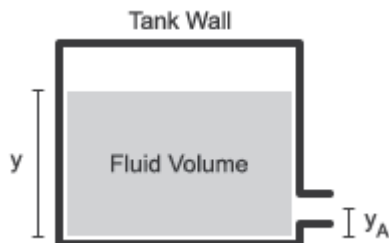

Tank Schematic

The tank can have up to six input ports, **A** through **F**. The pressure at the tank inlets is the sum of the constant tank pressurization specified in the block dialog box and the hydrostatic pressure due to the inlet height.

The tank model accounts for heat transfer through the tank wall, associated with thermal conserving port **H**. The temperature defined at this port is the temperature of the tank fluid volume.

Tank Volume

The tank fluid volume is computed from the total fluid mass at each time step:

$$V = \frac{m}{\rho},$$

where:

- V is the tank fluid volume.
- m is the tank fluid mass.
- ρ is the tank fluid density.

Mass Balance

The mass conservation equation in the tank fluid volume is

$$\dot{m} = \dot{m}_A,$$

where:

- \dot{m} is the net mass flow rate into the tank.
- \dot{m}_A is the mass flow rate into the tank fluid volume through the inlet **A**.

Momentum Balance

The momentum conservation equation in the tank fluid volume is

$$p_A + p_{dyn} = p_{Ref} + \rho g(y - y_A),$$

where:

- p_A is the fluid pressure at inlet **A**.
- p_{Ref} is the constant tank pressurization.
- p_{dyn} is the dynamic pressure:

$$p_{dyn} = \begin{cases} 0, & \dot{m}_A \geq 0 \\ \frac{\dot{m}_A^2}{2\rho_A S_A^2}, & \dot{m}_A < 0 \end{cases}$$

- ρ_A is the liquid density at port **A**.
- S_A is the tank inlet area.
- g is the gravitational constant.
- y is the tank level, or height, relative to the tank bottom.
- y_A is the tank inlet elevation relative to the tank bottom.

Energy Balance

The energy conservation equation in the tank fluid volume is

$$m(C_p - h\alpha)\dot{T} = \Phi_A - \dot{m}_A h + Q,$$

where:

- C_p is the fluid thermal capacity.
- α is the fluid isobaric bulk modulus.
- T is the fluid temperature.
- Φ_A is the energy flow rate into the tank through port **A**.
- h is the fluid enthalpy.
- Q is the thermal energy flow rate into the tank through port **H**.

Assumptions and Limitations

- The tank pressure is constant and uniform throughout the tank volume. The tank elevation head affects only the inlet pressure calculations.
- Fluid momentum is lost at the tank inlet due to the sudden expansion into the tank volume.

Note The tank fluid level should remain above the port height at all times. If you have not set **Liquid level below inlet height** to Warn or Error and the liquid level falls below this height, your simulation may return inaccurate results when fluid flows out of the tank. Connected components in the thermal liquid library are assumed to be fully filled with liquid throughout the simulation.

Ports

Conserving

A — Liquid port

thermal liquid

Tank inlet.

B — Liquid port

thermal liquid

Optional tank inlet.

Dependencies

To enable this port, set **Number of inlets** to 2, 3, 4, 5, or 6.

C — Liquid port

thermal liquid

Optional tank inlet.

Dependencies

To enable this port, set **Number of inlets** to 3, 4, 5, or 6.

D — Liquid port

thermal liquid

Optional tank inlet.

Dependencies

To enable this port, set **Number of inlets** to 4, 5, or 6.

E — Liquid port

thermal liquid

Optional tank inlet.

Dependencies

To enable this port, set **Number of inlets** to 5, or 6.

F – Liquid port

thermal liquid

Optional tank inlet.

DependenciesTo enable this port, set **Number of inlets** to 6.**H – Heat transfer**

thermal liquid

Heat transfer at the tank wall.

Output**V – Liquid volume, m³**

physical signal

Liquid volume inside the tank in m³, specified as a physical signal.**L – Liquid level, m**

physical signal

Liquid level inside the tank in m, specified as a physical signal.

T – Fluid temperature, K

physical signal

Tank fluid temperature in K, specified as a physical signal.

Parameters**Number of inlets – Number of inlet ports**

1 (default) | 2 | 3 | 4 | 5 | 6

Number of inlet ports. Setting this parameter to 2 or more exposes additional input ports.

Pressurization specification – Tank pressure

Atmospheric pressure (default) | Specified pressure

Specifies a constant tank pressure. You can define a non-atmospheric pressure by selecting **Specified pressure** and defining the value in **Tank pressurization**.**Tank pressurization – User-defined tank pressure**

0.101325 MPa (default) | positive scalar

User-defined tank pressure.

Tank volume parameterization – Tank area characteristics

Constant cross-section area (default) | Tabulated data - volume vs. level

Specifies tank area characteristics. This parameter is used to determine the fluid level in the tank. If you would like to model a tank with a variable cross-sectional area, you can provide data for tank volume and fluid level in the **Tabulated data - volume vs. level** option.

Tank cross-sectional area — Tank cross-sectional area1 m² (default) | positive scalar

Tank cross-sectional area.

Dependencies

To enable this parameter, set **Tank volume parameterization** to Constant cross-section area.

Liquid level vector — Vector of tank fluid levels[0, 3, 5] m (default) | 1-by-*n* vector

Vector of tank fluid levels for the tabular parameterization of a non-constant tank area. The values in this vector correspond one-to-one to values in the **Volumetric flow rate vector** parameter. Its elements are listed in ascending order. The elements must be positive and the first element must be 0.

Dependencies

To enable this parameter, set **Tank volume parameterization** to Tabulated data - volume vs. level.

Liquid volume vector — Vector of tank fluid levels[0, 4, 6] m³ (default) | 1-by-*n* vector

Vector of tank fluid levels for the tabular parameterization of a non-constant tank area. The values in this vector correspond one-to-one to values in the **Volumetric flow rate vector** parameter. Its elements are listed in ascending order. The elements must be positive and the first element must be 0.

Dependencies

To enable this parameter, set **Tank volume parameterization** to Tabulated data - volume vs. level.

Inlet height — Height of inlet port

0.1 m (default) | positive scalar

Height of inlet port. The value must be greater than or equal to 0.

Dependencies

To enable this parameter, set **Number of inlets** to 1.

Inlet cross-sectional area — Cross-sectional area of the port inlet0.01 m² (default) | positive scalar

Cross-sectional area of the port inlet. This value must be greater than 0.

Height vector for inlets A and B — Vector of port heights for multiple enabled ports[.1, 0] m (default) | 1-by-*n* vector

Vector of port heights for multiple enabled ports. If you have two or more ports enabled, the **Inlet height** parameter becomes a vector of values that correspond to the height of each inlet port, starting with port **A**. The parameter name will include all enabled ports. Each element of this vector must be greater than or equal to 0.

Dependencies

To enable this parameter, set **Number of inlets** to 2, 3, 4, 5, or 6.

Cross-sectional area vector for inlets A and B – Vector of inlet areas for two enabled ports

[.01, .01] m² (default) | 1-by-*n* vector

Vector of cross-sectional areas for multiple enabled ports. If you have two or more ports enabled, the **Inlet cross-sectional area** parameter becomes a vector of values that correspond to the cross-sectional area of each inlet, starting with port **A**. The parameter name will include all enabled ports. Each element of this vector must be greater than 0.

Dependencies

To enable this parameter, set **Number of inlets** to 2, 3, 4, 5, or 6.

Liquid level below inlet height – Whether to be notified of low tank levels

Error (default) | Warning | None

Whether to be notified if the tank fluid level falls below the port inlet height during simulation. Set this parameter to **Warning** if you would like to receive a warning when this occurs during simulation. Set the parameter to **Error** if you would like the simulation to stop when this occurs.

Liquid volume above max capacity – Whether to be notified of high tank volume

None (default) | Warning | Error

Whether to be notified if the tank fluid volume rises above the tank maximum capacity during simulation. Set this parameter to **Warning** if you would like to receive a warning when this occurs during simulation. Set the parameter to **Error** if you would like the simulation to stop when this occurs.

Maximum tank capacity – Fill limit of the tank

10 m³ (default) | positive scalar

Fill limit of the tank.

Dependencies

To enable this parameter, set **Liquid volume above max capacity** to either:

- Warning
- Error

Gravitational acceleration – Acceleration of gravity constant

9.81 m/s² (default) | positive scalar

Constant for the acceleration of gravity.

Extended Capabilities**C/C++ Code Generation**

Generate C and C++ code using Simulink® Coder™.

See Also

Gas-Charged Accumulator (TL)

Introduced in R2016a

Temperature Control Valve (G)

Valve with inlet thermostat to regulate flow

Library: Simscape / Fluids / Gas / Valves & Orifices / Flow Control
Valves



Description

The Temperature Control Valve (G) block models an orifice with a thermostat as a flow control mechanism. The thermostat contains a temperature sensor and a black-box opening mechanism—one whose geometry and mechanics matter less than its effects. The sensor is at the inlet and it responds with a slight delay, captured by a first-order time lag, to variations in temperature.

When the sensor reads a temperature in excess of a preset activation value, the opening mechanism is actuated. The valve begins to open or close, depending on the chosen operation mode—the first case corresponding to a normally closed valve and the second to a normally open valve. The change in opening area continues up to the limit of the valve's temperature range, beyond which point the opening area is a constant. Within the temperature range, the opening area is a linear function of temperature.

The flow can be laminar or turbulent, and it can reach (up to) sonic speeds. This happens at the vena contracta, a point just past the throat of the valve where the flow is both its narrowest and fastest. The flow then chokes and its velocity saturates, with a drop in downstream pressure no longer sufficing to increase its velocity. Choking occurs when the back-pressure ratio hits a critical value characteristic of the valve. Supersonic flow is not captured by the block.

Control Temperature

The temperature reading at the inlet serves as the control signal for the valve. The greater its rise over the activation temperature, the more the opening area diverges from its normal state—maximally closed in the default **Valve operation** setting of **Opens above activation temperature**, fully open in the alternative setting.

The difference between the sensor temperature reading and the activation temperature is referred to here as the temperature overshoot. For use in the block calculations, this variable is normalized against the temperature regulation range of the valve (that over which the opening area is variable). Its value is computed in this (normalized) form using the expression:

$$\hat{T} = \frac{T_S - T_A}{\Delta T},$$

where T is temperature. The overhead $\hat{}$ symbol denotes its normalized value while the subscripts S and A indicate the inlet sensor reading and the activation value (a constant obtained from the block parameter of the same name). The difference ΔT is the temperature regulation of the valve (it too obtained from a block parameter of the same name).

Sensor Dynamics

To emulate a real temperature sensor, which can register a shift in temperature only gradually, the block adds a first-order time lag to the temperature reading, T_S . The lag gives the sensor a transient response to variations in temperature. This response is captured in the expression:

$$\frac{d}{dt}T_S = \frac{T_{In} - T_S}{\tau},$$

where τ is the time required for the sensor to register a step change in temperature. Its value is obtained from the **Sensor time constant** block parameter. The smaller it is, the faster the sensor responds. The subscript In denotes the actual inlet temperature at the current time step of the simulation.

Numerical Smoothing

The normalized temperature overshoot spans three pressure regions. Below the activation temperature, its value is a constant zero. Above the maximum temperature—the sum of the activation temperature and the temperature regulation range—it is 1. In between, it varies, as a linear function of the temperature sensor reading, T_S .

The transitions between the regions are sharp and their slopes discontinuous. These pose a challenge to variable-step solvers (the sort commonly used with Simscape models). To precisely capture discontinuities, referred to in some contexts as *zero crossing events*, the solver must reduce its time step, pausing briefly at the time of the crossing in order to recompute its Jacobian matrix (a representation of the dependencies between the state variables of the model and their time derivatives).

This solver strategy is efficient and robust when discontinuities are present. It makes the solver less prone to convergence errors—but it can considerably extend the time needed to finish the simulation run, perhaps excessively so for practical use in real-time simulation. An alternative approach, used here, is to remove the discontinuities altogether.

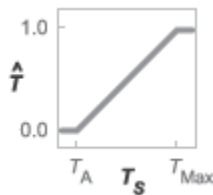

Normalized temperature overshoot with sharp transitions

To remove the slope discontinuities, the block smoothes them over a small portion of the opening curve. The smoothing, which adds a slight distortion at each transition, ensures that the valve eases into its limiting positions rather than snap (abruptly) into them. The smoothing is optional: you can disable it by setting its time scale to zero. The shape and scale of the smoothing, when applied, derives in part from the cubic polynomials:

$$\lambda_L = 3\bar{T}_L^2 - 2\bar{T}_L^3$$

and

$$\lambda_R = 3\bar{T}_R^2 - 2\bar{T}_R^3$$

where

$$\bar{T}_L = \frac{\hat{T}}{\Delta T^*}$$

and

$$\bar{T}_R = \frac{\hat{T} - (1 - \Delta T^*)}{\Delta T^*}.$$

In the equations:

- λ_L is the smoothing expression for the transition from the maximally closed position.
- λ_R is the smoothing expression for the transition from the fully open position.
- Δp^* is the (unitless) characteristic width of the temperature smoothing region:

$$\Delta T^* = f^* \frac{1}{2},$$

where f^* is a smoothing factor valued between 0 and 1 and obtained from the block parameter of the same name.

When the smoothing factor is 0, the normalized temperature overshoot stays in its original form—no smoothing applied—and its transitions remain abrupt. When it is 1, the smoothing spans the whole of the temperature regulation range (with the normalized temperature overshoot taking the shape of an S-curve).

At intermediate values, the smoothing is limited to a fraction of that range. A value of 0.5, for example, will smooth the transitions over a quarter of the temperature regulation range on each side (for a total smooth region of half the regulation range).

The smoothing adds two new regions to the normalized temperature overshoot—one for the smooth transition on the left, another for that on the right, giving a total of five regions. These are expressed in the piecewise function:

$$\hat{T}^* = \begin{cases} 0, & \hat{T} \leq 0 \\ \hat{T} \lambda_L, & \hat{T} < \Delta T^* \\ \hat{T}, & \hat{T} \leq 1 - \Delta T^*, \\ \hat{T} (1 - \lambda_R) + \lambda_R, & \hat{T} < 1 \\ 1 & \hat{T} \geq 1 \end{cases}$$

where the asterisk denotes a smoothed variable (the normalized temperature overshoot). The figure shows the effect of smoothing on the sharpness of the transitions.

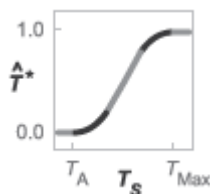

Sonic Conductance

As the opening area varies during simulation, so does the mass flow rate through the valve. The relationship between the two variables, however, is indirect. The mass flow rate is defined in terms of the valve's sonic conductance and it is this quantity that the opening area truly determines.

Sonic conductance, if you are unfamiliar with it, describes the ease with which a gas will flow when it is choked—when its velocity is at its theoretical maximum (the local speed of sound). Its measurement and calculation are covered in detail in the ISO 6358 standard (on which this block is based).

Only one value is commonly reported in valve data sheets: one taken at steady state in the fully open position. This is the same specified in the block dialog box (when the **Valve parameterization** setting is **Sonic conductance**). For values across the opening range of the valve, this maximum is scaled by the (normalized) valve opening area:

$$C(S) = \frac{S}{S_{\text{Max}}} C_{\text{Max}},$$

where C is sonic conductance and the subscript **Max** denotes the specified (manufacturer's) value. The sonic conductance varies linearly between C_{Max} in the fully open position and $S_{\text{Leak}} \div S_{\text{Max}} \times C_{\text{Max}}$ in the maximally closed position—a value close to zero and due only to internal leakage between the ports.

Other Parameterizations

Because sonic conductance may not be available (or the most convenient choice for your model), the block provides several equivalent parameterizations. Use the **Valve parameterization** drop-down list to select the best for the data at hand. The parameterizations are:

- Restriction area
- Sonic conductance
- Cv coefficient (USCS)
- Kv coefficient (SI)

The parameterizations differ only in the data that they require of you. Their mass flow rate calculations are still based on sonic conductance. If you select a parameterization other than **Sonic conductance**, then the block converts the alternate data—the (computed) opening area or a (specified) flow coefficient—into an equivalent sonic conductance.

Flow Coefficients

The flow coefficients measure what is, at bottom, the same quantity—the flow rate through the valve at some agreed-upon temperature and pressure differential. They differ only in the standard conditions used in their definition and in the physical units used in their expression:

- C_v is measured at a generally accepted temperature of 60 °F and pressure drop of 1 PSI; it is expressed in imperial units of US gpm. This is the flow coefficient used in the model when the **Valve parameterization** block parameter is set to **Cv coefficient (USCS)**.
- K_v is measured at a generally accepted temperature of 15 °C and pressure drop of 1 bar; it is expressed in metric units of m³/h. This is the flow coefficient used in the model when the **Valve parameterization** block parameter is set to **Kv coefficient (SI)**.

Sonic Conductance Conversions

If the valve parameterization is set to **Cv Coefficient (USCS)**, the sonic conductance is computed at the maximally closed and fully open valve positions from the **Cv coefficient (SI) at maximum flow** and **Cv coefficient (SI) at leakage flow** block parameters:

$$C = (4 \times 10^{-8} C_v) m^3 / (sPa),$$

where C_v is the flow coefficient value at maximum or leakage flow. The subsonic index, m , is set to 0.5 and the critical pressure ratio, b_{cr} , is set to 0.3. (These are used in the mass flow rate calculations given in the Momentum Balance section.)

If the **Kv coefficient (SI)** parameterization is used instead, the sonic conductance is computed at the same valve positions (maximally closed and fully open) from the **Kv coefficient (USCS) at maximum flow** and **Kv coefficient (USCS) at leakage flow** block parameters:

$$C = (4.758 \times 10^{-8} K_v) m^3 / (sPa),$$

where K_v is the flow coefficient value at maximum or leakage flow. The subsonic index, m , is set to 0.5 and the critical pressure ratio, b_{cr} , is set to 0.3.

For the **Restriction area** parameterization, the sonic conductance is computed (at the same valve positions) from the **Maximum opening area**, and **Leakage area** block parameters:

$$C = (0.128 \times 4S/\pi)L/(sbar),$$

where S is the opening area at maximum or leakage flow. The subsonic index, m , is set to 0.5 while the critical pressure ratio, b_{cr} is computed from the expression:

$$0.41 + 0.272 \left[\frac{\hat{T}(S_U - S_L) + S_L}{S} \right]^{0.25},$$

where S is the valve opening area and the subscripts U and L denote its values at the upper (U) and lower (L) bounds of the temperature regulation range. These depend on the setting of the **Valve operation** parameter (Opens above activation temperature or Closes above activation temperature).

Momentum Balance

The causes of those pressure losses incurred in the passages of the valve are ignored in the block. Whatever their natures—sudden area changes, flow passage contortions—only their cumulative effect is considered during simulation. This effect is assumed to reflect entirely in the sonic conductance of the valve (or in the data of the alternate valve parameterizations).

Mass Flow Rate

When the flow is choked, the mass flow rate is a function of the sonic conductance of the valve and of the thermodynamic conditions (pressure and temperature) established at the inlet. The function is linear with respect to pressure:

$$\dot{m}_{ch} = C \rho_0 P_{in} \sqrt{\frac{T_0}{T_{in}}},$$

where:

- C is the sonic conductance inside the valve. Its value is obtained from the block parameter of the same name or by conversion of other block parameters (the exact source depending on the **Valve parameterization** setting).
- ρ is the gas density, here at standard conditions (subscript θ), obtained from the **Reference density** block parameter.
- p is the absolute gas pressure, here corresponding to the inlet (in).
- T is the gas temperature at the inlet (in) or at standard conditions (θ), the latter obtained from the **Reference temperature** block parameter.

When the flow is subsonic, and therefore no longer choked, the mass flow rate becomes a nonlinear function of pressure—both that at the inlet as well as the reduced value at the outlet. In the turbulent flow regime (with the outlet pressure contained in the back-pressure ratio of the valve), the mass flow rate expression is:

$$\dot{m}_{\text{tur}} = C\rho_0 p_{\text{in}} \sqrt{\frac{T_0}{T_{\text{in}}}} \left[1 - \left(\frac{p_r - b_{\text{cr}}}{1 - b_{\text{cr}}} \right)^2 \right]^m,$$

where:

- p_r is the back-pressure ratio, or that between the outlet pressure (p_{out}) and the inlet pressure (p_{in}):

$$P_r = \frac{p_{\text{out}}}{p_{\text{in}}}$$

- b_{cr} is the critical pressure ratio at which the flow becomes choked. Its value is obtained from the block parameter of the same name or by conversion of other block parameters (the exact source depending on the **Valve parameterization** setting).
- m is the *subsonic index*, an empirical coefficient used to more accurately characterize the behavior of subsonic flows. Its value is obtained from the block parameter of the same name or by conversion of other block parameters (the exact source depending on the **Valve parameterization** setting).

When the flow is laminar (and still subsonic), the mass flow rate expression changes to:

$$\dot{m}_{\text{lam}} = C\rho_0 p_{\text{in}} \left[\frac{1 - p_r}{1 - b_{\text{lam}}} \right] \sqrt{\frac{T_0}{T_{\text{in}}}} \left[1 - \left(\frac{b_{\text{lam}} - b_{\text{cr}}}{1 - b_{\text{cr}}} \right)^2 \right]^m$$

where b_{lam} is the critical pressure ratio at which the flow transitions between laminar and turbulent regimes (obtained from the **Laminar flow pressure ratio** block parameter). Combining the mass flow rate expressions into a single (piecewise) function, gives:

$$\dot{m} = \begin{cases} \dot{m}_{\text{lam}}, & b_{\text{lam}} \leq p_r < 1 \\ \dot{m}_{\text{tur}}, & b_{\text{cr}} \leq p_r < p_{\text{lam}}, \\ \dot{m}_{\text{ch}}, & p_r < b_{\text{cr}} \end{cases}$$

with the top row corresponding to subsonic and laminar flow, the middle row to subsonic and turbulent flow, and the bottom row to choked (and therefore sonic) flow.

Mass Balance

The volume of fluid inside the valve, and therefore the mass of the same, is assumed to be very small and it is, for modeling purposes, ignored. As a result, no amount of gas can accumulate there. By the

principle of conservation of mass, the mass flow rate into the valve through one port must therefore equal that out of the valve through the other port:

$$\dot{m}_A + \dot{m}_B = 0,$$

where \dot{m} is defined as the mass flow rate *into* the valve through port **A** or **B**. Note that in this block the flow can reach but not exceed sonic speeds.

Energy Balance

The valve is modeled as an adiabatic component. No heat exchange can occur between the gas and the wall that surrounds it. No work is done on or by the gas as it traverses from inlet to outlet. With these assumptions, energy can flow by advection only, through ports **A** and **B**. By the principle of conservation of energy, the sum of the port energy flows must then always equal zero:

$$\phi_A + \phi_B = 0,$$

where ϕ is defined as the energy flow rate *into* the valve through one of the ports (**A** or **B**).

Ports

Conserving

A – Valve entrance

gas

Opening through which the working fluid can enter or exit the valve. The direction of flow depends on the pressure differential established across the valve. Both forward and backward directions are allowed.

B – Valve entrance

gas

Opening through which the working fluid can enter or exit the valve. The direction of flow depends on the pressure differential established across the valve. Both forward and backward directions are allowed.

Parameters

Basic Parameters

Valve operation – Sign of the change in opening area induced by warming

Opens above activation temperature (default) | Closes above activation temperature

Sign of the change in opening area induced by warming. The opening area can expand with a rise in temperature or it can contract. The change begins at an activation temperature and continues with warming conditions throughout the temperature regulation range of the valve.

The default setting corresponds to a normally closed valve that opens with rising temperature; the alternative setting corresponds to a normally open valve that closes with the same.

Activation temperature – Temperature at which the opening mechanism is triggered

330 K (default) | scalar in units of temperature

Temperature at which the opening mechanism is triggered. Warming above this temperature will either open or close the valve, depending on the setting of the **Valve operation** parameter. The opening area remains variable throughout the temperature regulation range of the valve.

Temperature regulation range — Span of the temperature interval over which the opening area is variable

8 K (default) | positive scalar in units of temperature

Span of the temperature interval over which the valve opening area varies with temperature. The interval begins at the activation temperature of the valve; it ends at the sum of the same with the regulation range specified here.

Sensor time constant — Time for a temperature change to register at the inlet sensor

1.5 s (default) | positive scalar in units of time

Characteristic time for a temperature change to register at the inlet sensor. This parameter determines the delay between the onset of a change and a stable measurement of the same (taken as the sensor nears its new steady state). A value of 0 means that the sensor responds instantaneously to a temperature change.

Valve parameterization — Method by which to characterize the opening of the valve

Sonic conductance (default) | Cv coefficient (USCS) | Kv coefficient (SI) |
Restriction area

Choice of ISO method to use in the calculation of mass flow rate. All calculations are based on the **Sonic conductance** parameterization; if a different option is selected, the data specified in converted into equivalent sonic conductance, critical pressure ratio, and subsonic index. See the block description for more information on the conversion.

This parameter determines which measures of valve opening you must specify—and therefore which of those measures appear as parameters in the block dialog box.

Cross-sectional area at ports A and B — Area normal to the flow path at the valve ports

0.01 m² (default) | positive scalar in units of area

Area normal to the flow path at the valve ports. The ports are assumed to be the same in size. The flow area specified here should ideally match those of the inlets of adjoining components.

Laminar flow pressure ratio — Pressure ratio at which the flow transitions between laminar and turbulent

0.999 (default) | positive unitless scalar

Pressure ratio at which the flow transitions between laminar and turbulent flow regimes. The pressure ratio is the fraction of the absolute pressure downstream of the valve over that just upstream of it. The flow is laminar when the actual pressure ratio is above the threshold specified here and turbulent when it is below. Typical values range from 0.995 to 0.999.

Reference temperature — ISO 8778 reference temperature

293.15 K (default) | scalar in units of temperature

Temperature at standard reference atmosphere, defined as 293.15 K in ISO 8778.

Reference density — ISO 8778 reference density

1.185 (default) | positive scalar in units of mass/volume

Density at standard reference atmosphere, defined as 1.185 kg/m³ in ISO 8778.

Model Parameterization Tab

Sonic conductance at maximum flow — Measure of maximum flow rate at reference upstream conditions

1.6 l/s/bar (default) | positive scalar in units of volume/time/pressure

Equivalent measure of the maximum flow rate allowed through the valve at some reference inlet conditions, generally those outlined in ISO 8778. The flow is at a maximum when the valve is fully open and the flow velocity is choked (it being saturated at the local speed of sound). This is the value generally reported by manufacturers in technical data sheets.

Sonic conductance is defined as the ratio of the mass flow rate through the valve to the product of the pressure and density upstream of the valve inlet. This parameter is often referred to in the literature as the *C-value*.

Dependencies

This parameter is active and exposed in the block dialog box when the **Valve parameterization** setting is Sonic conductance.

Sonic conductance at leakage flow — Measure of minimum flow rate at reference upstream conditions

1e-5 l/s/bar (default) | positive scalar in units of volume/time/pressure

Equivalent measure of the minimum flow rate allowed through the valve at some reference inlet conditions, generally those outlined in ISO 8778. The flow is at a minimum when the valve is maximally closed and only a small leakage area—due to sealing imperfections, say, or natural valve tolerances—remains between its ports.

Sonic conductance is defined as the ratio of the mass flow rate through the valve to the product of the pressure and density upstream of the valve inlet. This parameter is often referred to in the literature as the *C-value*.

This parameter serves primarily to ensure that closure of the valve does not cause portions of the gas network to become isolated (a condition known to cause problems in simulation). The exact value specified here is less important than its being a (very small) number greater than zero.

Dependencies

This parameter is active and exposed in the block dialog box when the **Valve parameterization** setting is Sonic conductance.

Critical pressure ratio — Back-pressure ratio, at reference upstream conditions, at which the flow rate is a maximum

0.3 (default) | positive unitless scalar

Ratio of downstream to upstream absolute pressures at which the flow becomes choked (and its velocity becomes saturated at the local speed of sound). This parameter is often referred to in the literature as the *b-value*. Enter a number greater than or equal to zero and smaller than the **Laminar flow pressure ratio** block parameter.

Dependencies

This parameter is active and exposed in the block dialog box when the **Valve parameterization** setting is Sonic conductance.

Subsonic index — Exponent used to more accurately characterize flow in the subsonic regime

0.5 (default) | positive unitless scalar

Empirical exponent used to more accurately calculate the mass flow rate through the valve when the flow is subsonic. This parameter is sometimes referred to as the *m-index*. Its value is approximately 0.5 for valves (and other components) whose flow paths are fixed.

Dependencies

This parameter is active and exposed in the block dialog box when the **Valve parameterization** setting is **Sonic conductance**.

Cv coefficient (USCS) at maximum flow — Flow coefficient of the fully open valve expressed in US customary units0.4 (default) | positive scalar in units of ft³/min

Flow coefficient of the fully open valve, expressed in the US customary units of ft³/min (as described in NFPA T3.21.3). This parameter measures the relative ease with which the gas will traverse the valve when driven by a given pressure differential. This is the value generally reported by manufacturers in technical data sheets.

Dependencies

This parameter is active and exposed in the block dialog box when the **Valve parameterization** setting is **Cv coefficient (USCS)**.

Cv coefficient (USCS) at leakage flow — Flow coefficient of the maximally closed valve expressed in US customary units1e-6 (default) | positive scalar in units of ft³/min

Flow coefficient of the maximally closed valve, expressed in the US customary units of ft³/min (as described in NFPA T3.21.3). This parameter measures the relative ease with which the gas will traverse the valve when driven by a given pressure differential.

The purpose of this parameter is primarily to ensure that closure of the valve does not cause portions of the gas network to become isolated (a condition known to cause problems in simulation). The exact value specified here is less important than its being a (very small) number greater than zero.

Dependencies

This parameter is active and exposed in the block dialog box when the **Valve parameterization** setting is **Cv coefficient (USCS)**.

Kv coefficient (SI) at maximum flow — Flow coefficient of the fully open valve expressed in SI units0.3 (default) | positive scalar in units of m³/hr

Flow coefficient of the fully open valve, expressed in the SI units of m³/hr. This parameter measures the relative ease with which the gas will traverse the valve when driven by a given pressure differential. This is the value generally reported by manufacturers in technical data sheets.

Dependencies

This parameter is active and exposed in the block dialog box when the **Valve parameterization** setting is **Kv coefficient (SI)**.

Kv coefficient (SI) at leakage flow — Flow coefficient of the maximally closed valve expressed in SI units1e-6 (default) | positive scalar in units of m^3/hr

Flow coefficient of the maximally closed valve, expressed in the SI units of m^3/hr . This parameter measures the relative ease with which the gas will traverse the valve when driven by a given pressure differential.

The purpose of this parameter is primarily to ensure that closure of the valve does not cause portions of the gas network to become isolated (a condition known to cause problems in simulation). The exact value specified here is less important than its being a (very small) number greater than zero.

Dependencies

This parameter is active and exposed in the block dialog box when the **Valve parameterization** setting is **Kv coefficient (SI)**.

Maximum opening area — Opening area in the fully open position due to sealing imperfections1e-4 m^2 (default) | positive scalar in units of area

Opening area of the valve in the fully open position, when the valve is at the upper limit of the pressure regulation range. The block uses this parameter to scale the chosen measure of valve opening—sonic conductance, say, or C_V flow coefficient—throughout the pressure regulation range.

Dependencies

This parameter is active and exposed in the block dialog box when the **Valve parameterization** setting is **Opening area**.

Leakage area — Opening area in the maximally closed position due to sealing imperfections1e-12 m^2 (default) | positive scalar in units of area

Opening area of the valve in the maximally closed position, when only internal leakage between the ports remains. This parameter serves primarily to ensure that closure of the valve does not cause portions of the gas network to become isolated (a condition known to cause problems in simulation). The exact value specified here is less important than its being a (very small) number greater than zero.

Dependencies

This parameter is active and exposed in the block dialog box when the **Valve parameterization** setting is **Opening area**.

Smoothing factor — Amount of smoothing to apply to the valve opening area function

0 (default)

Amount of smoothing to apply to the opening area function of the valve. This parameter determines the widths of the regions to be smoothed—one located at the fully open position, the other at the fully closed position.

The smoothing superposes on each region of the opening area function a nonlinear segment (a third-order polynomial function, from which the smoothing arises). The greater the value specified here, the greater the smoothing is, and the broader the nonlinear segments become.

At the default value of 0, no smoothing is applied. The transitions to the maximally closed and fully open positions then introduce discontinuities (associated with zero-crossings), which tend to slow down the rate of simulation.

Variables Tab

Sensor Temperature – Inlet temperature at the start of simulation

293.15 K (default) | scalar in units of temperature

Initial condition for the temperature at the inlet of the valve. The block uses a first-order time lag to determine how this temperature will vary during simulation. Set the **Priority** option to **Low** to ignore the value specified here should conflicts with other initial conditions exist.

Extended Capabilities

C/C++ Code Generation

Generate C and C++ code using Simulink® Coder™.

See Also

Variable Orifice ISO 6358 (G) | Ball Valve (G) | Gate Valve (G)

Introduced in R2018b

Temperature Control Valve (TL)

Flow control valve with temperature-based actuation

Library: Simscape / Fluids / Thermal Liquid / Valves & Orifices / Flow Control Valves



Description

The Temperature Control Valve (TL) block models an orifice with a thermostat as a flow control mechanism. The thermostat contains a temperature sensor and a black-box opening mechanism—one whose geometry and mechanics matter less than its effects. The sensor responds with a slight delay, captured by a first-order time lag, to variations in temperature.

When the sensor reads a temperature in excess of a preset activation value, the opening mechanism is actuated. The valve begins to open or close, depending on the chosen operation mode—the first case corresponding to a normally closed valve and the second to a normally open valve. The change in opening area continues up to the limit of the valve's temperature regulation range, beyond which the opening area is a constant.

A smoothing function allows the valve opening area to change smoothly between the fully closed and fully open positions. The smoothing function does this by removing the abrupt opening area changes at the zero and maximum ball positions. The figure shows the effect of smoothing on the valve opening area curve.

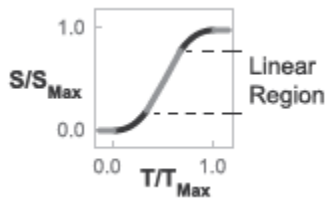

Opening-Area Curve Smoothing

Valve Opening Area

The valve opening area calculation is based on the linear expression

$$S_{Linear} = \left(\frac{S_{End} - S_{Start}}{T_{Range}} \right) (T_{Sensor} - T_{Activation}) + S_{Start}$$

where:

- S_{Linear} is the linear valve opening area.
- S_{Start} is the valve opening area at the beginning of the temperature actuation range. This area depends on the **Valve operation** parameter setting:

$$S_{Start} = \begin{cases} S_{Leak}, & \text{Valve opens above activation temperature} \\ S_{Max}, & \text{Valve closes above activation temperature} \end{cases}$$

- S_{End} is the valve opening area at the end of the temperature actuation range. This area depends on the **Valve operation** parameter setting:

$$S_{End} = \begin{cases} S_{Max}, & \text{Valve opens above activation temperature} \\ S_{Leak}, & \text{Valve closes above activation temperature} \end{cases}$$

- S_{Max} is the valve opening area in the fully open position.
- S_{Leak} is the valve opening area in the fully closed position. Only leakage flow remains in this position.
- T_{Range} is the temperature regulation range.
- $T_{Activation}$ is the minimum temperature required to operate the valve.
- T_{Sensor} is the measured valve temperature.

The valve model accounts for a first-order lag in the measured valve temperature through the differential equation:

$$\frac{d}{dt}(T_{Sensor}) = \frac{T_{Avg} - T_{Sensor}}{\tau},$$

where:

- T_{Avg} is the arithmetic average of the valve port temperatures,

$$T_{Avg} = \frac{T_A + T_B}{2},$$

where T_A and T_B are the temperatures at ports A and B.

- τ is the **Sensor time constant** value specified in the block dialog box.

The valve opening expressions introduce undesirable discontinuities at the fully open and fully closed positions. The block eliminates these discontinuities using polynomial expressions that smooth the transitions to and from the fully open and fully closed positions. The valve smoothing expressions are

$$\lambda_L = 3\bar{T}_L^2 - 2\bar{T}_L^3$$

and

$$\lambda_R = 3\bar{T}_R^2 - 2\bar{T}_R^3$$

where:

$$\bar{T}_L = \frac{T_{Sensor} - T_{Activation}}{\Delta T_{smooth}}$$

and

$$\bar{T}_R = \frac{T_{Sensor} - (T_{Activation} + T_{Range} - \Delta T_{smooth})}{\Delta T_{smooth}}.$$

In the equations:

- λ_L is the smoothing expression for the fully closed portion of the valve opening curve.
- λ_R is the smoothing expression applied to the fully open portion of the valve opening curve.
- ΔT_{smooth} is the temperature smoothing region:

$$\Delta T_{smooth} = f_{smooth} \frac{T_{Range}}{2},$$

where f_{smooth} is a smoothing factor between 0 and 1.

The smoothed valve opening area is given by the piecewise conditional expression

$$S_R = \begin{cases} S_{Start}, & T_{Sensor} \leq T_{Activation} \\ S_{Start}(1 - \lambda_L) + S_{Linear}\lambda_L, & T_{Sensor} < T_{Activation} + \Delta T_{smooth} \\ S_{Linear}, & T_{Sensor} < T_{Activation} + T_{Range} - \Delta T_{smooth}, \\ S_{Linear}(1 - \lambda_R) + S_{End}\lambda_R, & T_{Sensor} < T_{Activation} + T_{Range} \\ S_{End}, & T_{Sensor} \geq T_{Activation} + T_{Range} \end{cases}$$

where:

- S_R is the smoothed valve opening area.

Mass Balance

The mass conservation equation in the valve is

$$\dot{m}_A + \dot{m}_B = 0,$$

where:

- \dot{m}_A is the mass flow rate into the valve through port A.
- \dot{m}_B is the mass flow rate into the valve through port B.

Energy Balance

The energy conservation equation in the valve is

$$\phi_A + \phi_B = 0,$$

where:

- ϕ_A is the energy flow rate into the valve through port A.
- ϕ_B is the energy flow rate into the valve through port B.

Momentum Balance

The momentum conservation equation in the valve is

$$p_A - p_B = \frac{\dot{m}\sqrt{\dot{m}^2 + \dot{m}_{cr}^2}}{2\rho_{Avg}C_d^2S^2} \left[1 - \left(\frac{S_R}{S} \right)^2 \right] PR_{Loss},$$

where:

- p_A and p_B are the pressures at port A and port B.
- \dot{m} is the mass flow rate.
- \dot{m}_{cr} is the critical mass flow rate:

$$\dot{m}_{cr} = Re_{cr} \mu_{Avg} \sqrt{\frac{\pi}{4}} S_R.$$

- ρ_{Avg} is the average liquid density.
- C_d is the discharge coefficient.
- S is the valve inlet area.
- PR_{Loss} is the pressure ratio:

$$PR_{Loss} = \frac{\sqrt{1 - (S_R/S)^2(1 - C_d^2)} - C_d(S_R/S)}{\sqrt{1 - (S_R/S)^2(1 - C_d^2)} + C_d(S_R/S)}.$$

Ports

- A — Thermal liquid conserving port representing valve inlet A
- B — Thermal liquid conserving port representing valve inlet B

Parameters

Parameters Tab

Valve operation

Effect of fluid temperature on valve operation. Options include `Opens above activation temperature` and `Closes above activation temperature`. The default setting is `Opens above activation temperature`.

Activation temperature

Temperature required to actuate the valve. If the **Valve operation** parameter is set to `Opens above activation temperature`, the valve begins to open at the activation temperature. If the **Valve operation** parameter is set to `Closes above activation temperature`, the valve begins to close at the activation temperature. The default value is 330 K.

Temperature regulation range

Temperature change from the activation temperature required to fully open the valve. The default value is 8 K, corresponding to a fully open valve at a temperature of 338 K.

Sensor time constant

Time constant in the first-order equation used to approximate the temperature sensor dynamics. The default value is 1.5 s.

Maximum opening area

Valve flow area in the fully open position. The default value is $1e-4 \text{ m}^2$.

Leakage area

Area through which fluid can flow in the fully closed valve position. This area accounts for leakage between the valve inlets. The default value is $1e-12 \text{ m}^2$.

Smoothing factor

Portion of the opening-area curve to smooth expressed as a fraction. Smoothing eliminates discontinuities at the minimum and maximum flow valve positions. The smoothing factor must be between 0 and 1.

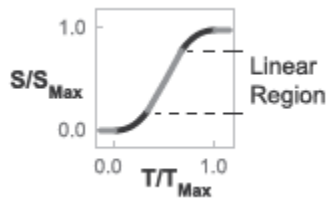

Opening-Area Curve Smoothing

A value of 0 corresponds to a linear expression with zero smoothing. A value of 1 corresponds to a nonlinear expression with maximum smoothing. The default value is 0.01, corresponding to a nonlinear region spanning 1% the size of the full curve.

Cross-sectional area at ports A and B

Area normal to the direction of flow at the valve inlets. This area is assumed the same for all the inlets. The default value is 0.01 m².

Characteristic longitudinal length

Approximate length of the valve. This parameter provides a measure of the longitudinal scale of the valve. The default value is 0.1 m.

Discharge coefficient

Semi-empirical parameter commonly used as a measure of valve performance. The discharge coefficient is defined as the ratio of the actual mass flow rate through the valve to its theoretical value.

The block uses this parameter to account for the effects of valve geometry on mass flow rates. Textbooks and valve data sheets are common sources of discharge coefficient values. By definition, all values must be greater than 0 and smaller than 1. The default value is 0.7.

Critical Reynolds number

Reynolds number corresponding to the transition between laminar and turbulent flow regimes. The flow through the valve is assumed laminar below this value and turbulent above it. The appropriate values to use depend on the specific valve geometry. The default value is 12.

Variables Tab

Sensor temperature

Fluid temperature at the start of simulation. The default value is 293.15 K, corresponding to room temperature.

Mass flow rate into port A

Mass flow rate into the component through port A at the start of simulation. The default value is 1 kg/s.

Extended Capabilities

C/C++ Code Generation

Generate C and C++ code using Simulink® Coder™.

See Also

Gate Valve (TL) | Ball Valve (TL)

Introduced in R2016a

Thermal Liquid Properties (TL)

Preset fluid properties for the simulation of a thermal liquid network

Library: Simscape / Fluids / Thermal Liquid / Utilities



Description

The Thermal Liquid Properties (TL) block set predefined fluid properties to a thermal liquid network. The available fluids include pure water, aqueous mixtures, diesel, aviation fuel Jet A, and SAE 5W-30. You can use this block as a preset alternative to the Thermal Liquid Settings (TL) block. If your network does not have a connected liquid properties block, or the liquid defaults will apply. See “Specify Fluid Properties” for more details

The preset fluid properties are defined in tabular form as functions of temperature and pressure. During simulation, the network properties are set by linear interpolation between data points. Tabular data for aqueous mixtures is provided for concentration by mass or volume.

All the fluid properties commonly specified in the Thermal Liquid Settings (TL) block are defined in the block. These properties include density, the bulk modulus and thermal expansion coefficient, the specific internal energy and specific heat, as well as the kinematic viscosity and thermal conductivity. The properties are valid over a limited region of temperatures and pressures specific to the fluid selected and dependent, in the cases of mixtures, on the concentration specified. Simulation is allowed within this validity region only.

Data Visualization

You can visualize the fluid properties defined in the block and the pressure and temperature regions of validity. To open the visualization utility, right-click the block and select **Fluids > Plot Fluid Properties**. The plot updates automatically upon selection of a fluid property from the drop-down list. Use the **Reload Data** button to regenerate the plot whenever the fluid selection or fluid parameters change.

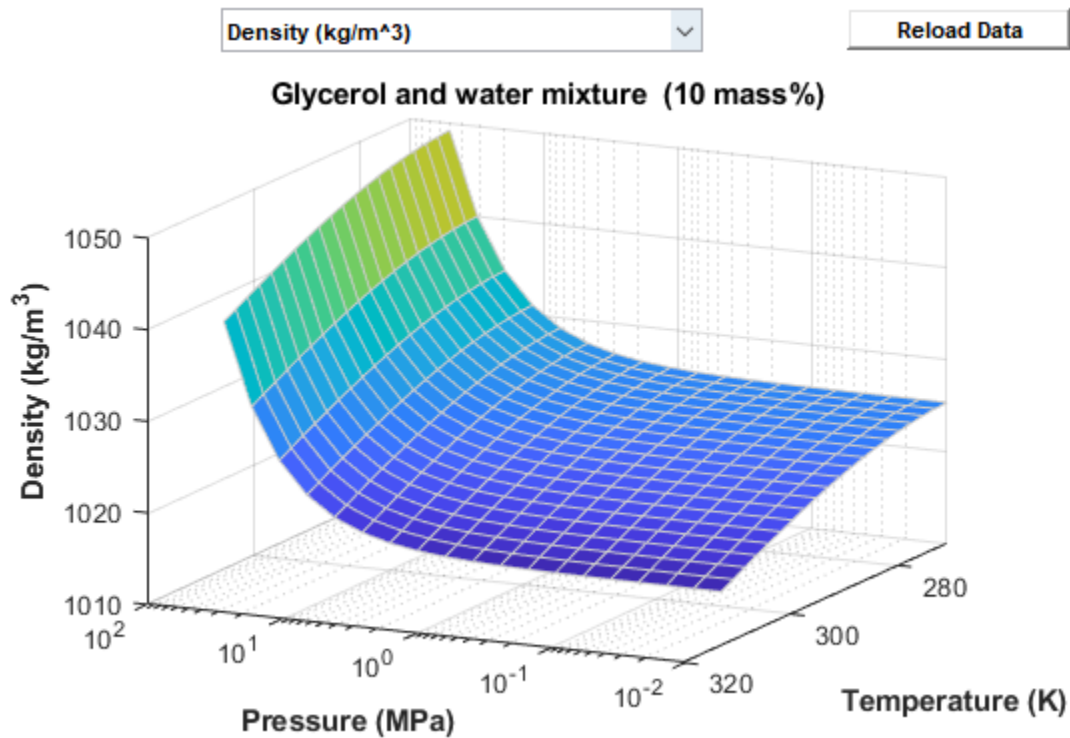

Visualization of density data for a 10% glycerol aqueous mixture

Validity Regions

The validity regions are defined in the block as matrices of zeros and ones. Each row corresponds to a tabulated temperature and each column to a tabulated pressure. A zero denotes an invalid breakpoint and a one a valid breakpoint. These validity matrices are internal to the block and cannot be modified; they can only be checked (using the data visualization utility of the block).

In most cases, the validity matrices are extracted directly from the tabulated data. The glycol and glycerol mixtures pressure boundaries are not available from the data, and are obtained explicitly from block parameters. The figure below shows an example of the validity region for water. The shaded squares indicate temperature and pressure regions outside of the validity region.

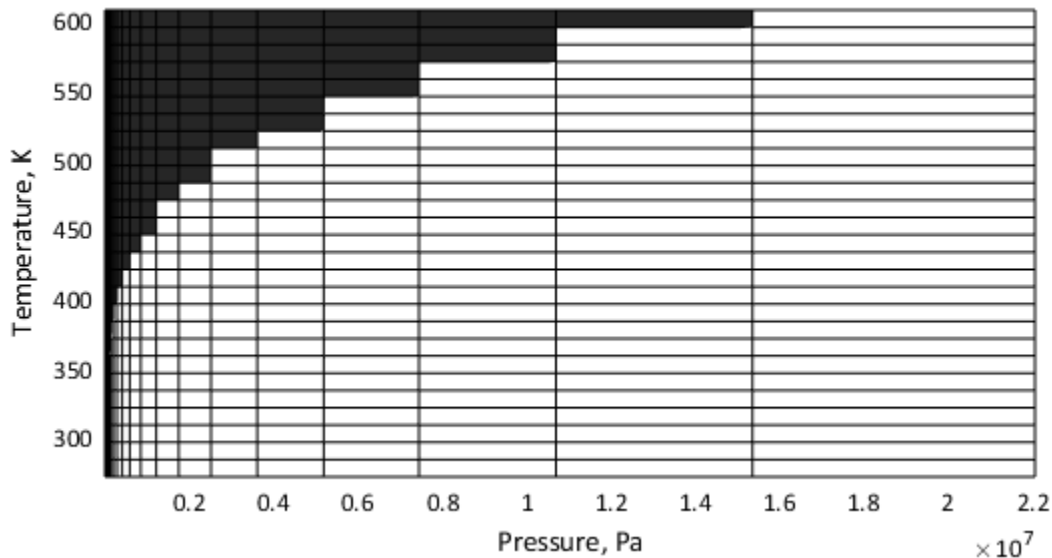

Water

The properties of water are valid at temperatures above the triple-point value (273.160 K) up to the critical-point value (647.096 K). They are valid at pressures above the greater of the triple-point value (611.657 Pa) on one hand and the temperature-dependent saturation value on the other, up to the critical-point value (22.064 MPa). Pressures below the saturation point for a given temperature row are assigned a value of 0 in the validity matrix.

Seawater (MIT model)

The properties of seawater are valid at temperatures above 0°C up to 120°C (273.15 K to 393.15 K); they are valid at pressures above the saturation point up to a maximum value of 12 MPa. Pressures below the saturation point for a given temperature row (and at the specified concentration level) are assigned a value of 0 in the validity matrix. Mixture concentrations can range in value from 0 to 0.12 on a mass fraction basis.

Ethylene glycol and water mixture

The properties of an aqueous ethylene glycol mixture are valid over a temperature domain determined from the mixture concentration; they are valid at pressures within the minimum and maximum bounds specified in the block dialog box (extended horizontally to span the width of the temperature rows).

The lower temperature bound is always the lesser of the minimum temperature extracted from the available data and the freezing point of the mixture (the mixture must be in the liquid state). The upper temperature bound is always the maximum temperature extracted from the data. Mixture concentrations can range in value from 0 to 0.6 if a mass-fraction basis is used, or from 0 to 1 if a volume fraction basis is used.

Propylene glycol and water mixture

The properties of an aqueous propylene glycol mixture are valid over the temperature and pressure ranges described for the case of Ethylene glycol and water mixture. Mixture concentrations can range in value from 0 to 0.6 if a mass-fraction basis is used, or from 0.1 to 0.6 if a volume fraction basis is used.

Glycerol and water mixture

The properties of an aqueous glycerol mixture are valid over the temperature and pressure ranges as described for the case of Ethylene glycol and water mixture. Mixture concentrations can range in value from 0 to 0.6 on a mass-fraction basis.

Aviation fuel Jet-A

The properties of Jet A fuel are valid at temperatures above -50.93°C up to 372.46°C (222.22 K to 645.61 K); they are valid at pressures above the saturation point up to a maximum value of 2.41 MPa. Pressures below the saturation point for a given temperature row are assigned a value of 0 in the validity matrix.

Diesel fuel

The properties of diesel fuel are valid at temperatures above -34.95°C up to 417.82°C (238.20 K to 690.97 K); they are valid at pressures above the saturation point up to a maximum value of 2.29 MPa. Pressures below the saturation point for a given temperature row are assigned a value of 0 in the validity matrix.

SAE 5W-30

The properties of SAE 5W-30 fuel derive from data covering different temperature and pressure ranges for each property but all extended by extrapolation to $(-38, 200)$ C and $(0.01, 100)$ MPa.

Calculated Properties

The density and thermal expansion coefficients of the aqueous mixtures of glycol and glycerol compounds are obtained from the block parameters. The fluid density, with respect to pressure and temperature, is calculated as:

$$\rho(T, p) = \rho(T) \exp\left(\frac{p - p_R}{\beta}\right),$$

where:

- T is the network temperature.
- p is the network pressure.
- ρ is the fluid density.
- p_R is the reference pressure associated with the fluid property tables.
- β is the isothermal bulk modulus.

where the change in fluid density is evaluated as:

$$\left(\frac{\partial \rho(T, p)}{\partial T}\right)_p = \left(\frac{\partial \rho(T)}{\partial T}\right)_T \exp\left(\frac{p - p_R}{\beta}\right).$$

The thermal expansion coefficient is calculated as:

$$\alpha(T, p) = -\frac{1}{\rho(T, p)} \left(\frac{\partial \rho(T)}{\partial T}\right)_T \exp\left(\frac{p - p_R}{\beta}\right).$$

Ports

Conserving

R – Thermal liquid network for which to define the working fluid

thermal liquid

Node identifying the thermal liquid network for which to define the necessary fluid properties. The fluid selected in this block applies to the entire network. No other Thermal Liquid Properties (TL) or Thermal Liquid Settings (TL) block may be connected to the same network.

Parameters

Thermal liquid fluid list – Available working fluids

Water (default) | Seawater (MIT model) | Ethylene glycol and water mixture | Propylene glycol and water mixture | Glycerol and water mixture | Diesel Fuel | Aviation fuel Jet-A | SAE 5W-30

Sets the fluid properties of your liquid network. The available fluids include pure water, aqueous mixtures, motor oils, and fuels.

Dissolved salt mass fraction (salinity) – Mass of salt divided by the total mass of the saline mixture

3.5e-3 (default) | positive unitless scalar valued between 0 and 1

Ratio of the mass of salt present in the saline mixture to the total mass of that mixture.

Dependencies

This parameter is active only when Seawater (MIT model) is selected as the working fluid.

Concentration type – Quantity in terms of which the mixture concentration is defined

Volume fraction (default) | Mass fraction

Quantity in terms of which to specify the concentration of ethylene glycol in its aqueous mixture. This parameter is active only when either Ethylene glycol and water mixture or Propylene glycol and water mixture is selected as the working fluid.

Ethylene glycol volume fraction – Volume of ethylene glycol divided by that of the aqueous mixture

0.1 (default) | positive unitless scalar valued between 0 and 1

Volume of ethylene glycol present in the aqueous mixture divided by the total volume of that mixture.

Dependencies

This parameter is active when Ethylene glycol and water mixture is selected as the working fluid and Volume fraction is selected as the concentration type.

Ethylene glycol mass fraction – Mass of ethylene glycol divided by that of the aqueous mixture

0.1 (default) | positive unitless scalar valued between 0 and 1

Mass of ethylene glycol present in the aqueous mixture divided by the total mass of that mixture.

Dependencies

This parameter is active when Ethylene glycol and water mixture is selected as the working fluid and Mass fraction is selected as the concentration type.

Propylene glycol volume fraction — Mass of propylene glycol divided by that of the aqueous mixture

0.1 (default) | positive unitless scalar valued between 0 and 1

Volume of propylene glycol present in the aqueous mixture divided by the total volume of that mixture.

Dependencies

This parameter is active when Propylene glycol and water mixture is selected as the working fluid and Volume fraction is selected as the concentration type.

Propylene glycol mass fraction — Mass of propylene glycol divided by that of the aqueous mixture

0.1 (default) | positive unitless scalar valued between 0 and 1

Mass of propylene glycol present in the aqueous mixture divided by the total mass of that mixture.

Dependencies

This parameter is active when Propylene glycol and water mixture is selected as the working fluid and Mass fraction is selected as the concentration type.

Isothermal bulk modulus — Measure of fluid compressibility specified at constant temperature

2.1791 GPa (default) | positive scalar with units of pressure

Bulk modulus of the aqueous mixture at constant temperature. The bulk modulus measures the change in pressure required to produce a fractional change in fluid volume.

Dependencies

This parameter is active when either Ethylene glycol and water mixture, Propylene glycol and water mixture, or Glycerol and water mixture is selected as the working fluid.

Minimum valid pressure — Lower bound of the allowed pressure range for the thermal liquid network

0.01 MPa (default) | positive scalar with units of pressure

Lower bound of the pressure range allowed in the thermal liquid network connected to this block.

Dependencies

This parameter is active when either Ethylene glycol and water mixture, Propylene glycol and water mixture, or Glycerol and water mixture is selected as the working fluid.

Maximum valid pressure — Upper bound of the allowed pressure range for the thermal liquid network

50 MPa (default) | positive scalar with units of pressure

Upper bound of the pressure range allowed in the thermal liquid network connected to this block.

Dependencies

This parameter is active when either Ethylene glycol and water mixture, Propylene glycol and water mixture, or Glycerol and water mixture is selected as the working fluid.

Atmospheric pressure — Absolute pressure in the environment of the thermal liquid network

0.101325 MPa (default) | positive scalar with units of pressure

Absolute pressure of the external environment in which the thermal liquid network is assumed to run. The default value is the standard atmospheric pressure measured at sea level on Earth.

References

- [1] Massachusetts Institute of Technology (MIT), *Thermophysical properties of seawater database*. <http://web.mit.edu/seawater>.
- [2] K.G. Nayar, M.H. Sharqawy, L.D. Banchik, J.H. Lienhard V, Thermophysical properties of seawater: A review and new correlations that include pressure dependence, *Desalination*, Vol. 390, pp. 1-24, 2016.
- [3] M.H. Sharqawy, J.H. Lienhard V, S.M. Zubair, Thermophysical properties of seawater: A review of existing correlations and data, *Desalination and Water Treatment*, Vol. 16, pp. 354-380.

Extended Capabilities

C/C++ Code Generation

Generate C and C++ code using Simulink® Coder™.

See Also

Thermal Liquid Settings (TL)

Introduced in R2018a

Thermostatic Expansion Valve (2P)

Flow control valve that maintains evaporator superheat for use in refrigeration cycles

Library: Simscape / Fluids / Two-Phase Fluid / Valves & Orifices / Flow Control Valves



Description

The Thermostatic Expansion Valve (2P) block models a valve with a pressure drop that maintains an evaporator superheat in a two-phase fluid network. This valve is typically placed between a condenser and evaporator in a refrigeration system and maintains a specific temperature differential by moderating the flow into the evaporator.

When the *superheat*, the difference in temperature between the vapor at the evaporator outlet and the fluid evaporating temperature, reaches the **Static (minimum) evaporator superheat**, the valve closes. This reduces the flow through the evaporator, which reduces the heat transfer in the evaporator and increases the evaporator outlet temperature. When you enable a maximum pressure or temperature limit with the **MOP limit for evaporating pressure** parameter, the valve closes when the limit is exceeded.

The bulb sensor at port **S** measures the evaporator outlet temperature. If the valve in your system has external pressure equalization, the evaporator outlet pressure is modeled by a line connection from the evaporator to port **E**. Otherwise, the pressure at port **B** is used for internal pressure equalization. The block balances the bulb pressure, which acts to open the valve, with the valve equalization pressure, which acts to close the valve.

Opening Area

The valve operates primarily to control the mass flow rate between a condenser and an evaporator by regulating the effective open area, S_{eff} . The mass flow rate is calculated as

$$\dot{m} = S_{eff} \sqrt{\frac{2}{v_{in}} \frac{\Delta p}{(\Delta p^2 - \Delta p_{lam}^2)^{0.25}}}$$

where:

- v_{in} is the inlet specific volume, or the fluid volume per unit mass.
- Δp is the pressure differential over the valve, $p_A - p_B$.
- Δp_{lam} is the pressure threshold for transitional flow. Below this value, the flow is laminar. It is calculated as:

$$\Delta p_{lam} = \frac{p_A + p_B}{2} (1 - B_{lam}),$$

where B_{lam} is the **Laminar flow pressure ratio**.

The effective valve area depends on the pressure difference between the measured pressure, p_{bulb} and the equalization pressure, p_{eq} :

$$S_{eff} = \beta[(p_{bulb} - p_{eq}) - p_{sat}(T_{evap} + \Delta T_{static}) - p_{sat}(T_{evap})],$$

where:

- β is a valve constant determined from nominal operating conditions. See “Determining β from Nominal Conditions” on page 1-1626 for more information.
- p_{sat} is the fluid saturation pressure, which is a function of temperature and evaluated at the indicated temperatures. $p_{sat}(T_{evap} + \Delta T_{static})$ is the saturation pressure at $T_{evap} + \Delta T_{static}$.
- T_{evap} is the **Nominal evaporating temperature**.
- ΔT_{static} is the **Static (minimum) evaporator superheat**.
- p_{bulb} is the fluid pressure of the bulb. The bulb pressure is the saturation pressure, $p_{bulb} = p_{sat}(T_{bulb})$, unless pressure limiting is enabled and the maximum pressure has been reached; see “MOP limit for evaporating pressure” on page 1-0 for more information. T_{bulb} is the bulb fluid temperature.
- p_{eq} depends on the valve pressure equalization setting:
 - If **Pressure equalization** is set to Internal pressure equalization, p_{eq} is the pressure at port B.
 - If **Pressure equalization** is set to External pressure equalization, p_{eq} is the pressure at port E.

The effective valve area has limits. The minimum effective valve area, $S_{eff,min}$, is

$$S_{eff,min} = f_{leak} S_{eff,nom},$$

where f_{leak} is the **Closed valve leakage flow as a fraction of nominal flow**. The nominal effective valve area, $S_{eff,nom}$ and maximum effective valve area are discussed in **Determining β from Nominal Conditions**.

Determining β from Nominal Conditions

β represents the relationship between the nominal evaporator superheat and the nominal evaporator capacity, the rate of heat transfer between the two fluids in the evaporator:

$$\beta = \frac{S_{eff,nom}}{[p_{sat}(T_{evap} + \Delta T_{nom}) - p_{sat}(T_{evap})]},$$

where $p_{sat}(T_{evap} + \Delta T_{nom})$ is the saturation pressure at the sum of the **Nominal evaporating temperature** and the **Nominal (static + opening) evaporator superheat**.

The nominal effective valve area, $S_{eff,nom}$, is calculated as a function of the nominal condenser and evaporator thermodynamics:

$$S_{eff,nom} = \frac{\left[\frac{Q_{nom}}{c_{p, evap} \Delta T_{nom} + h_{evap} - h_{cond} + c_{p, cond} \Delta T_{sub}} \right]}{\sqrt{\frac{2}{v_{cond}} (p_{sat}(T_{cond}) - p_{sat}(T_{evap}))}},$$

where:

- T_{cond} is the **Nominal condensing temperature**.
- v_{cond} is the liquid specific volume at T_{cond} .
- Q_{nom} is the **Nominal evaporator capacity**.
- $c_{p,evap}$ is the vapor specific heat at T_{evap} .
- h_{evap} is the vapor specific enthalpy at T_{evap} .
- $c_{p,cond}$ is the liquid specific heat at T_{cond} .
- h_{cond} is the liquid specific enthalpy at T_{cond} .
- ΔT_{sub} is the **Nominal condenser subcooling**. *Subcooling* is the difference in temperature between the condenser outlet and the condensing temperature.

The maximum effective area of the valve is determined in the same way as $S_{eff,nom}$, but instead uses **Maximum evaporator capacity** in the place of the **Nominal evaporator capacity**.

Pressure Equalization

The equalization pressure is the pressure at the evaporator outlet that governs valve operability. In physical systems with low pressure loss in the evaporator due to viscous friction, pressure equalization can occur internally with the pressure at port **B**. This is referred to as *internal pressure equalization*. In systems with larger losses, connect the evaporator outlet port to the valve block at port **E**.

MOP Limit for Evaporating Pressure

You can limit to the maximum pressure in the evaporator by specifying a maximum pressure or associated temperature with the **MOP limit for evaporating pressure** parameter. If enabled, the valve closes when the bulb temperature exceeds the temperature associated with maximum bulb pressure, and opens once the pressure reduces. If **MOP limit for evaporating pressure** is set to **Off**, or the measured pressure is below the limit, $p_{bulb} = p_{sat}(T_{bulb})$. If enabled, when the measurement exceeds the limit, the bulb pressure remains at

$$p_{bulb} = \frac{p_{bulb,MOP}}{T_{bulb,MOP}} T_{bulb},$$

where:

- $p_{bulb,MOP}$ is a function of the **Maximum operating pressure**, $p_{eq,MOP}$, or the pressure associated with the **Maximum operating temperature**, and the nominal evaporator temperature:

$$p_{bulb,MOP} = p_{eq,MOP} + p_{sat}(T_{evap} + \Delta T_{static}) - p_{sat}(T_{evap}).$$

- T_{bulb} is the bulb fluid temperature. This is the temperature at port **S** if **Bulb temperature dynamics** is set to **Off**. A first-order delay is applied to the bulb temperature if **Bulb temperature dynamics** is set to **On**.
- $T_{bulb,MOP}$ is the associated temperature at the pressure $p_{bulb,MOP}$.

Bulb Temperature Dynamics

You can model the bulb dynamic response to changing temperatures by setting **Bulb temperature dynamics** to **On**. This introduces a first-degree lag in the measured temperature:

$$\frac{dT_{bulb}}{dt} = \frac{T_S - T_{bulb}}{\tau_{bulb}},$$

where:

- T_S is the temperature at port **S**. If bulb dynamics are not modeled, this is T_{bulb} .
- τ_{bulb} is the **Bulb thermal time constant**.

Fluid Specific Volume Dynamics

When the fluid at the valve inlet is a liquid-vapor mixture, the block calculates the specific volume as:

$$v_{in} = (1 - x_{dyn})v_{liq} + x_{dyn}v_{vap}$$

where:

- x_{dyn} is the inlet vapor quality. The block applies a first-order lag to the inlet vapor quality of the mixture.
- v_{liq} is the liquid specific volume of the fluid.
- v_{vap} is the vapor specific volume of the fluid.

If the inlet fluid is liquid or vapor, v_{in} is the respective liquid or vapor specific volume.

Vapor Quality Lag

If the inlet vapor quality is a liquid-vapor mixture, the block applies a first-order time lag:

$$\frac{dx_{dyn}}{dt} = \frac{x_{in} - x_{dyn}}{\tau}$$

where:

- x_{dyn} is the dynamic vapor quality.
- x_{in} is the current inlet vapor quality.
- τ is the **Inlet phase change time constant**.

If the inlet fluid is a subcooled liquid, x_{dyn} is equal to x_{in} .

Conservation Equations

Mass is conserved through the valve:

$$\dot{m}_A + \dot{m}_B = 0,$$

where:

- \dot{m}_A is the mass flow rate at port **A**.
- \dot{m}_B is the mass flow rate at port **B**.

Reversed flows are numerically supported, however, the valve block is not designed for flows from port **B** to port **A**.

Energy flow is also conserved through the valve:

$$\Phi_A + \Phi_B = 0,$$

where:

- Φ_A is the energy flow rate at port **A**.
- Φ_B is the energy flow rate at port **B**.

Ports

Conserving

A – Fluid inlet

two-phase fluid

Valve inlet port. Connect this port to the outlet of a condenser or liquid receiver within a refrigeration cycle model.

B – Fluid outlet

two-phase fluid

Valve outlet port. Connect this port to the inlet of an evaporator within a refrigeration cycle model.

S – Sensing bulb temperature measurement

two-phase fluid

Temperature measurement port representing a sensing bulb. Connect this port to the outlet port of the evaporator. The valve operation is based on the comparison of the sensed temperature at **S** to the fluid saturation temperature.

There is no mass or energy flow rate through port **S**.

E – Equalization line pressure measurement

two-phase fluid

Pressure measurement port representing the pressure equalization line. Connect this port to the outlet port of the evaporator.

There is no mass or energy flow rate through port **E**.

Dependencies

To enable this port, set **Pressure equalization** to External pressure equalization.

Parameters

Nominal evaporator capacity – Evaporator heat transfer rate in nominal conditions

15 kW (default) | positive scalar

Rate of heat transfer in the system evaporator under nominal operating conditions. This parameter sets the operational conditions of the thermostatic expansion valve.

Maximum evaporator capacity – Maximum evaporator heat transfer rate

20 kW (default) | positive scalar

Maximum rate of heat transfer in the system evaporator. In most refrigeration cycles, this value is 20% to 50% larger than the **Nominal evaporator capacity**. This parameter sets the maximum operating conditions for the thermostatic expansion valve.

Nominal evaporating temperature – Evaporator saturation temperature in nominal conditions

278.15 K (default) | positive scalar

Refrigerant saturation temperature in the evaporator under nominal operating conditions.

Static (minimum) evaporator superheat – Minimum allowable temperature differential at the evaporator outlet

5 deltaK (default) | positive scalar

Minimum allowed difference between the superheated vapor temperature at the evaporator outlet and the **Nominal evaporating temperature**. If the operational difference falls below this value, the valve is closed.

Nominal (static + opening) evaporator superheat – Operational evaporator outlet temperature differential

10 deltaK (default) | positive scalar

Difference between the superheated vapor temperature at the evaporator outlet and the **Nominal evaporating temperature** under nominal operating conditions. The valve maintains this value by adjusting its open area to allow more or less fluid into the evaporator.

Nominal condensing temperature – Refrigerant saturation temperature in the condenser

313.15 K (default) | positive scalar

Refrigerant saturation temperature in the condenser under nominal operating conditions.

Nominal condenser subcooling – Operational condenser outlet temperature differential

5 deltaK (default) | positive scalar

Difference between the **Nominal condensing temperature** and the liquid temperature at the condenser outlet under nominal operating conditions.

Pressure equalization – Pressure measurement location

Internal pressure equalization (default) | External pressure equalization

Pressure measurement location. Set this to `Internal pressure equalization` to measure the evaporator pressure at port **B**. Set this parameter to `External pressure equalization` to measure the evaporator pressure at port **E**, which is connected to the evaporator outlet. This setting depends on the design of the thermostatic expansion valve.

MOP limit for evaporating pressure – Whether to enable pressure or temperature limits

Off (default) | On - Specify maximum operating pressure | On - Specify maximum operating temperature

Whether to enable pressure limits in the evaporator. The options are:

- **Off:** There is no pressure limit. The valve opens and closes based only on the evaporator superheat.
- **On - Specify maximum operating pressure:** This setting places an upper limit on the evaporating pressure and temperature. The valve closes when this pressure is reached.
- **On - Specify maximum operating temperature:** This setting places an upper limit on the evaporating pressure and temperature. The valve closes when this temperature is reached.

Maximum operating pressure — Maximum pressure when evaporator pressure limiting is on

0.5 MPa (default) | positive scalar

Maximum permissible saturation pressure in the evaporator.

Dependencies

To enable this parameter, set **MOP limit for evaporating pressure** to On - Specify maximum operating pressure.

Maximum operating temperature — Maximum temperature when evaporator temperature limiting is on

288.15 K (default) | positive scalar

Maximum permissible saturation temperature in the evaporator.

Dependencies

To enable this parameter, set **MOP limit for evaporating pressure** to On - Specify maximum operating temperature.

Bulb temperature dynamics — Whether to model thermal lag

Off (default) | On

Whether to model thermal dynamics in temperature measurement. When set to On, the bulb fluid temperature lags the refrigeration temperature. The **Bulb thermal time constant** determines the lag response.

Bulb thermal time constant — Thermal lag time constant

20 s (default) | positive scalar

First-order time constant for the bulb fluid temperature delay. The measured temperature is delayed relative to the refrigerant temperature at port **S**. The time constant is proportional to the thermal mass of the bulb (including any ballast) and inversely proportional to the thermal conductance across the thermal contact surface.

Dependencies

To enable this parameter, set **Bulb temperature dynamics** to On.

Cross-sectional area at ports A and B — Port area0.01 m² (default) | positive scalar

Cross-sectional area of connecting pipes at ports **A** and **B**.

Closed valve leakage flow as a fraction of nominal flow — Minimum flow through the valve at all times

1e-9 (default) | positive scalar

Fraction of leakage to nominal flow through the valve when it is closed. A nonzero value enhances numerical stability in the fluid network.

Laminar flow pressure ratio — Ratio of evaporator pressures at flow regime transition

0.999 (default) | positive scalar

Ratio of the evaporator outlet pressure to evaporator inlet pressure at which the fluid transitions between the laminar and turbulent regimes. The pressure loss corresponds to the mass flow rate linearly in laminar flows and quadratically in turbulent flows.

Smoothing factor – Numerical smoothing factor

0.01 (default) | positive scalar in the range [0,1]

Continuous smoothing factor that introduces a layer of gradual change to the flow response when the valve is in near-open or near-closed positions. Set this value to a nonzero value less than one to increase the stability of your simulation in these regimes.

Inlet phase change time constant – Lag for mixture specific volume

0.1 s (default) | positive scalar

Time lag for liquid-vapor mixtures in computing the fluid specific volume. This parameter does not influence the specific volume when the inlet fluid is a fully supercooled liquid.

References

[1] Eames, Ian W., Adriano Milazzo, and Graeme G. Maidment. "Modelling Thermostatic Expansion Valves." *International Journal of Refrigeration* 38 (February 2014): 189-97.

See Also

Introduced in R2020b

Turbine (G)

Gas turbine in a thermodynamic cycle

Library: Simscape / Fluids / Gas / Turbomachinery



Description

The Turbine (G) block models a turbine in a gas network. You can parameterize the block as a tabulated turbine map that is either a 1-D function of pressure ratio or 2-D function of pressure ratio and corrected mass flow rate. Fluid flowing from port **A** to port **B** generates torque. Port **R** reports shaft torque and angular velocity relative to port **C**, which is associated with the turbine casing.

Port **VN** is associated with the vane opening fraction. This value linearly scales the corrected mass flow rate but does not influence the turbine efficiency. A value of 1 corresponds to the data in the turbine map.

Turbine Map

A turbine map depicts turbine performance as a function of pressure ratio, the turbine inlet pressure to the outlet pressure, and corrected mass flow rate. Two graphs plot the isentropic efficiency and the corrected mass flow rate. In the 2D parameterization, the plots also depend on the corrected rotor speed, N . The indexing variable β does not need to be the same between the mass flow rate and efficiency tables.

Corrected Mass Flow Rate

Due to the large changes in pressure and temperature inside a turbine, the turbine map plots performance in terms of a corrected mass flow rate. The corrected mass flow rate is adjusted from the inlet mass flow rate with a corrected pressure and corrected temperature:

$$\dot{m}_A \sqrt{\frac{T_A}{T_{corr}}} = \dot{m}_{corr} \frac{p_A}{p_{corr}},$$

where:

- \dot{m}_A is the mass flow rate at port **A**.
- T_A is the temperature at port **A**.
- T_{corr} is the **Reference temperature for corrected flow**. The data supplier specifies this value.
- \dot{m}_{corr} is the corrected mass flow rate.

When **Turbine map parameterization** is set to Tabulated data - Flow rate and efficiency vs. pressure ratio, this is the **Corrected mass flow rate vector, $\dot{m}_{dot}(pr)$** .

When **Turbine map parameterization** is set to Tabulated data - Flow rate and efficiency vs. corrected speed and pressure ratio, this is the **Corrected mass flow rate table, $\dot{m}_{dot}(N,beta)$** .

- p_A is the pressure at port **A**.

- p_{corr} is the **Reference pressure for corrected flow**. The data supplier specifies this value.

Shaft Torque

The shaft torque, τ , is calculated as:

$$\tau = \frac{\eta_m \dot{m}_A \Delta h_{total}}{\omega},$$

where:

- Δh_{total} is the total change in the fluid specific enthalpy.
- η_m is the turbine **Mechanical efficiency**.
- ω is the relative shaft angular velocity, $\omega_R - \omega_C$.

Reversed flow, from port **B** to port **A**, is outside of the typical turbine operation mode and may not return accurate results. A threshold region when flow approaches zero ensures that no torque is generated when the flow rate is near zero or reversed.

Parameterization by Pressure Ratio

When **Turbine map parameterization** is set to Tabulated data - Flow rate and efficiency vs. pressure ratio, the turbine isentropic efficiency and mass flow rate are a function of the pressure ratio and do not account for any changes in the turbine rotational speed.

The last element of the **Corrected mass flow rate vector, $\mathbf{mdot}(\mathbf{pr})$** and the **Pressure ratio vector, \mathbf{pr}** represent the corrected mass flow rate and pressure ratio at choked flow conditions.

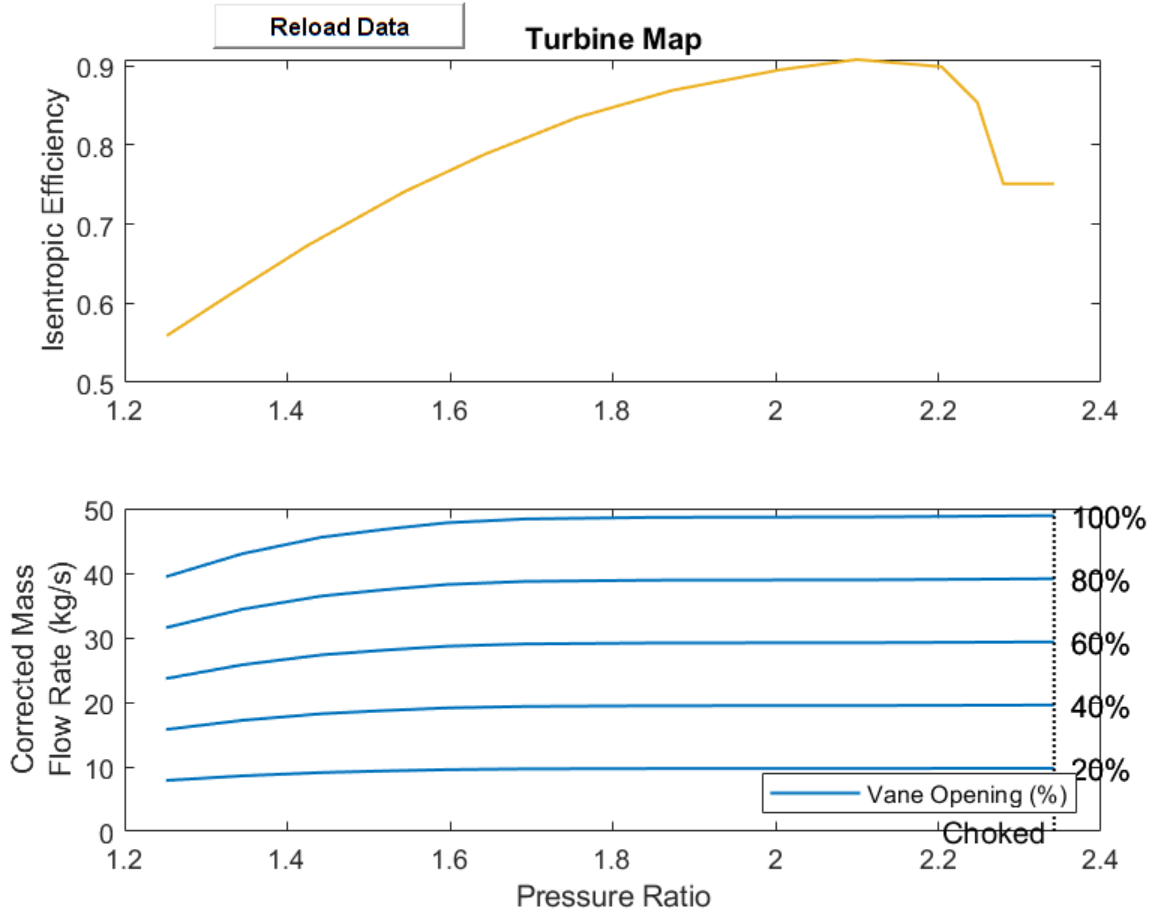

Default Turbine Map in the 1-D Parameterization

Parameterization by Pressure Ratio and Corrected Mass Flow Rate

When **Turbine map parameterization** is set to Tabulated data - Flow rate and efficiency vs. corrected speed and pressure ratio, the turbine isentropic efficiency, pressure ratio, and corrected mass flow rate are a function of the corrected speed, N , and the map index, β . The block uses linear interpolation between data points for the efficiency, pressure ratio, and corrected mass flow rate parameters.

The last column of the **Corrected mass flow rate table, $\dot{m}(N,\beta)$** and the **Pressure ratio table, $pr(N,\beta)$** represent the corrected mass flow rate and pressure ratio at choked flow conditions.

Visualizing the Block Turbine Map

To visualize the block map, right-click the block and select **Fluids > Plot Turbine Map**.

Each time you modify the block settings, click **Apply** click **Reload Data** on the figure window.

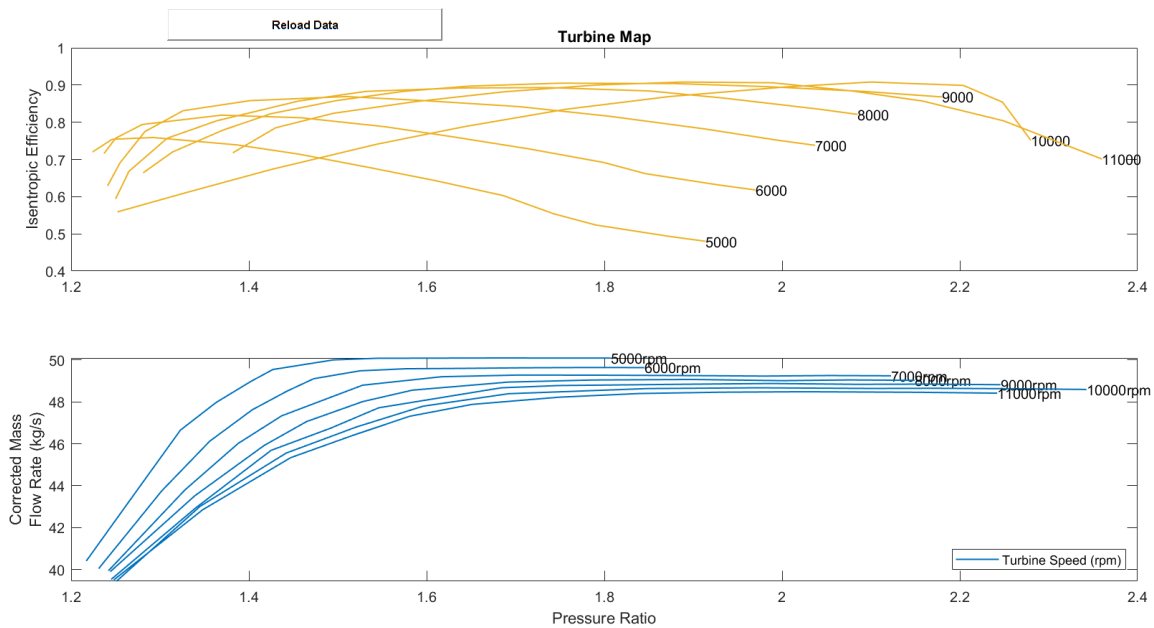

Default Turbine Map in the 2-D Parameterization

Continuity Equations

Mass is preserved over the block:

$$\dot{m}_A + \dot{m}_B = 0,$$

where \dot{m}_B is the mass flow rate at port **B**.

The energy balance in the block is calculated as:

$$\Phi_A + \Phi_B - P_{fluid} = 0,$$

where:

- Φ_A is the energy flow rate at port **A**.
- Φ_B is the energy flow rate at port **B**.
- P_{fluid} is the work done by the fluid, which is determined from the change in total fluid specific enthalpy: $P_{fluid} = \dot{m}_A \Delta h_{total}$.

Assumptions and Limitations

- The shaft does not rotate under reversed flow conditions. Results during reversed flows may not be accurate.

Ports

Conserving

A — Gas inlet

gas

Fluid entry port.

B – Gas outlet

gas

Fluid exit port.

C – Turbine case

mechanical translational

Port associated with the turbine casing.

R – Turbine shaft

mechanical translational

Port associated with the turbine shaft torque and angular velocity.

Input

VN – Vane opening fraction

physical signal

Vane opening fraction. The corrected mass flow rate scales linearly with the value of **VN**. A fraction of 1 corresponds to the tabulated data. The isentropic efficiency is not influenced by the vane opening fraction.

Parameters

Parameterization

Turbine map parameterization – Performance parameterization

Tabulated data - Flow rate and efficiency vs. pressure ratio (default) | Tabulated data - Flow rate and efficiency vs. corrected speed and pressure ratio

Performance parameterization specification:

- Tabulated data - Flow rate and efficiency vs. pressure ratio: Parameterize turbine isentropic efficiency and corrected mass flow rate by pressure ratio.
- Tabulated data - Flow rate and efficiency vs. corrected speed and pressure ratio: Parameterize turbine isentropic efficiency and corrected mass flow rate by corrected speed and pressure ratio.

Minimum vane opening – Minimum opening fraction

1e-3 (default) | positive scalar in the range (0,1]

Minimum vane opening fraction. This value is the lower boundary to the signal at **VN**. It is multiplied by the elements of the **XX** or **XX** parameters to obtain the minimum corrected mass flow rate through the turbine.

Maximum vane opening – Maximum opening fraction

1 (default) | positive scalar in the range (0,1]

Maximum vane opening. This value is the upper boundary to the signal at **VN**. It is multiplied by the elements of the **XX** or **XX** parameters to obtain the maximum corrected mass flow rate through the turbine.

Corrected speed index vector, N – Tabulated data shaft speed indices

100 .* [50, 60, 70, 80, 90, 100, 110] rpm (default) | vector of positive scalars

Vector of constant shaft speeds for tabular parameterization of corrected mass flow rate and isentropic efficiency.

Dependencies

To enable this parameter, set **Turbine map parameterization** to Tabulated data - Flow rate and efficiency vs. corrected speed and pressure ratio.

Flow Rate Data**Pressure ratio vector, pr – Vector of pressure ratios**

[1.251, 1.345, 1.442, 1.521, 1.596, 1.692, 1.849, 1.972, 2.1, 2.173, 2.259, 2.3424] (default) | vector of positive scalars

Vector of pressure ratio values for the tabulated parameterization of corrected mass flow rate. This vector must have the same number of elements as the **Corrected mass flow rate vector, mdot(pr)** parameter and all elements must be greater than 1. The last element must be the pressure ratio at choked conditions.

Dependencies

To enable this parameter, set **Turbine map parameterization** to Tabulated data - Flow rate and efficiency vs. pressure ratio.

Corrected mass flow rate vector, mdot(pr) – Vector of corrected mass flow rate values

[39.439, 43.01, 45.556, 46.801, 47.792, 48.388, 48.634, 48.67, 48.689, 48.747, 48.825, 48.912] kg/s (default) | vector of positive scalars

Vector of corrected mass flow rate values for the tabulated parameterization of corrected mass flow rate. This vector must have the same number of elements as the **Pressure ratio vector, pr** parameter and all elements must be greater than 0. The last element must be the corrected mass flow rate at choked conditions.

Dependencies

To enable this parameter, set **Turbine map parameterization** to Tabulated data - Flow rate and efficiency vs. pressure ratio.

Pressure ratio table, pr(N,beta) – Turbine map pressure ratio data

M-by-*N* matrix (default)

M-by-*N* matrix of turbine outlet-to-inlet pressure ratios at the specified corrected shaft speed and β value. Linear interpolation is employed between table elements. *M* and *N* are the sizes of the corresponding vectors:

- *M* is the number of vector elements in the **Corrected speed index vector, N** parameter.
- *N* is the number of β indices in the table.

The default table values are:

[1.217, 1.285, 1.323, 1.363, 1.402, 1.427, 1.495, 1.545, 1.6, 1.687, 1.747, 1.8074; 1.231, 1.302, 1.356, 1.404, 1.443, 1.473, 1.525, 1.577, 1.635, 1.709,

1.782, 1.845; 1.242, 1.328, 1.388, 1.437, 1.528, 1.617, 1.704, 1.811, 1.915, 1.979, 2.053, 2.1226; 1.244, 1.339, 1.417, 1.465, 1.528, 1.584, 1.692, 1.787, 1.899, 2, 2.075, 2.1492; 1.245, 1.34, 1.425, 1.492, 1.546, 1.684, 1.748, 1.882, 1.987, 2.084, 2.167, 2.2458; 1.251, 1.345, 1.442, 1.521, 1.596, 1.692, 1.849, 1.972, 2.1, 2.173, 2.259, 2.3424; 1.248, 1.348, 1.447, 1.516, 1.581, 1.651, 1.749, 1.839, 1.93, 2.024, 2.154, 2.242]

Dependencies

To enable this parameter, set **Turbine map parameterization** to Tabulated data - Flow rate and efficiency vs. corrected speed and pressure ratio.

Corrected mass flow rate table, $\dot{m}(N, \beta)$ — Turbine map corrected mass flow rate data

M-by-*N* matrix (default)

M-by-*N* matrix of corrected mass flow rates at the specified corrected shaft speed and β value. Linear interpolation is employed between table elements. *M* and *N* are the sizes of the corresponding vectors:

- *M* is the number of vector elements in the **Constant speed index vector**, **N** parameter.
- *N* is the number of β indices in the table.

The default table values are:

[40.403, 44.417, 46.653, 47.966, 48.97, 49.544, 50.001, 50.081, 50.086, 50.095, 50.09, 50.0922; 40.044, 43.754, 46.125, 47.626, 48.513, 49.105, 49.481, 49.58, 49.597, 49.624, 49.638, 49.633; 39.941, 43.795, 46.017, 47.335, 48.795, 49.199, 49.279, 49.27, 49.248, 49.23, 49.255, 49.2428; 39.896, 43.512, 45.914, 47.061, 48.011, 48.558, 48.943, 49.042, 49.069, 49.01, 49.046, 49.0266; 39.524, 42.934, 45.686, 46.743, 47.715, 48.67, 48.777, 48.836, 48.876, 48.836, 48.845, 48.8184; 39.439, 43.01, 45.556, 46.801, 47.792, 48.388, 48.634, 48.67, 48.639, 48.647, 48.625, 48.5912; 39.502, 42.849, 45.336, 46.385, 47.312, 47.877, 48.222, 48.397, 48.459, 48.482, 48.455, 48.414] kg/s

Dependencies

To enable this parameter, set **Turbine map parameterization** to Tabulated data - Flow rate and efficiency vs. corrected speed and pressure ratio.

Efficiency Data

Pressure ratio vector, **pr** — Vector of pressure ratios

[1.252, 1.328, 1.425, 1.544, 1.642, 1.757, 1.873, 2.005, 2.1, 2.204, 2.248, 2.28] (default) | vector of positive scalars

Vector of pressure ratio values for the tabulated parameterization of isentropic efficiency. This vector must have the same number of elements as the **Isentropic efficiency vector, $\eta(\mathbf{pr})$** parameter and all elements must be greater than 1.

Dependencies

To enable this parameter, set **Turbine map parameterization** to Tabulated data - Flow rate and efficiency vs. pressure ratio.

Isentropic efficiency vector, eta(pr) – Vector of isentropic efficiencies

[.559, .61, .673, .741, .788, .835, .869, .895, .908, .899, .854, .751]
(default) | vector of elements in the range (0,1]

Vector of isentropic efficiency values for the tabulated parameterization of isentropic efficiency. This vector must have the same number of elements as the **Pressure ratio vector, pr** parameter and all elements must be greater than 0 and less than or equal to 1.

Dependencies

To enable this parameter, set **Turbine map parameterization** to Tabulated data - Flow rate and efficiency vs. pressure ratio.

Pressure ratio table, pr(N,beta) – Turbine map pressure ratio data

M-by-*N* matrix (default) |

M-by-*N* matrix of turbine outlet-to-inlet pressure ratios at the specified corrected shaft speed and β value. Linear interpolation is employed between table elements. *M* and *N* are the sizes of the corresponding vectors:

- *M* is the number of vector elements in the **Constant speed index vector, N** parameter.
- *N* is the number of β indices in the table.

The default table values are:

[1.224, 1.246, 1.292, 1.387, 1.457, 1.534, 1.61, 1.686, 1.743, 1.79, 1.871, 1.914; 1.237, 1.25, 1.28, 1.369, 1.459, 1.553, 1.629, 1.716, 1.799, 1.846, 1.927, 1.97; 1.241, 1.255, 1.283, 1.326, 1.401, 1.509, 1.591, 1.704, 1.806, 1.913, 1.994, 2.037; 1.25, 1.265, 1.308, 1.364, 1.456, 1.532, 1.637, 1.739, 1.851, 1.934, 2.042, 2.085; 1.281, 1.314, 1.371, 1.425, 1.498, 1.574, 1.647, 1.749, 1.878, 1.979, 2.091, 2.18; 1.252, 1.328, 1.425, 1.544, 1.642, 1.757, 1.873, 2.005, 2.1, 2.204, 2.248, 2.28; 1.382, 1.43, 1.495, 1.586, 1.688, 1.791, 1.887, 1.99, 2.079, 2.158, 2.249, 2.217]

Dependencies

To enable this parameter, set **Turbine map parameterization** to Tabulated data - Flow rate and efficiency vs. corrected speed and pressure ratio.

Isentropic efficiency table, eta(N,beta) – Turbine map isentropic efficiency data

M-by-*N* matrix (default)

M-by-*N* matrix of turbine isentropic efficiencies at the specified constant shaft speed and β value. Linear interpolation is employed between table elements. *M* and *N* are the sizes of the corresponding vectors:

- *M* is the number of vector elements in the **Constant speed index vector, N** parameter.
- *N* is the number of β indices in the table.

The default table values are:

[.72, .754, .759, .739, .714, .679, .643, .603, .554, .524, .494, .48; .716, .757, .794, .819, .812, .788, .761, .728, .692, .662, .632, .618; .629, .691, .775, .831, .858, .869, .859, .842, .816, .782, .752, .738; .594, .668, .757, .804, .857, .883, .892, .893, .884, .865, .835, .821; .664, .72, .779, .823,

.858, .883, .897, .905, .904, .896, .883, .868; .559, .61, .673, .741, .788, .835, .869, .895, .908, .899, .854, .751; .718, .785, .824, .855, .882, .9, .908, .906, .884, .857, .804, .701]

Dependencies

To enable this parameter, set **Turbine map parameterization** to Tabulated data - Flow rate and efficiency vs. corrected speed and pressure ratio.

Reference Data

Reference pressure for corrected flow — Correcting pressure

0.101325 MPa (default) | positive scalar

Pressure at which turbine data consolidates to a corrected trend line.

Reference temperature for corrected flow — Correcting temperature

288.15 K (default) | positive scalar

Temperature at which turbine data becomes consolidated to a corrected trend line.

Mechanical efficiency — Efficiency of conversion to torque

0.9 (default) | positive scalar in the range [0,1]

Efficiency of conversion from reduction in specific enthalpy to shaft torque.

Inlet area at port A — Turbine inlet area

1 m² (default) | positive scalar

Turbine inlet cross-sectional area.

Outlet area at port B — Turbine outlet area

1 m² (default) | positive scalar

Turbine outlet cross-sectional area.

References

- [1] Kurzke, Joachim. "How to Get Component Maps for Aircraft Gas Turbine Performance Calculations." *Volume 5: Manufacturing Materials and Metallurgy; Ceramics; Structures and Dynamics; Controls, Diagnostics and Instrumentation; Education; General*, American Society of Mechanical Engineers, 1996, p. V005T16A001.
- [2] Plencner, Robert M. "Plotting component maps in the Navy/NASA Engine Program (NNEP): A method and its usage." *NASA Technical Memorandum*, 1989.

See Also

Compressor (G)

Topics

"Brayton Cycle (Gas Turbine)"

Introduced in R2021a

Two-Phase Fluid Predefined Properties (2P)

Predefined working fluids for two-phase networks

Library: Simscape / Fluids / Two-Phase Fluid / Utilities



Description

The Two-Phase Fluid Predefined Properties (2P) block sets the working fluid properties of your two-phase system. The available predefined fluids are:

- Water (R-718)
- R-134a
- R-1234yf
- R-404a
- R-410a
- R-407c
- R-22
- Ammonia (R-717)
- CO₂ (R-744)
- Isobutane (R-600a)

If you would like to specify your own working fluid properties, use the Foundation Library Two-Phase Fluid Properties (2P) block. If you do not specify a fluid, the system defaults will apply. See “Specify Fluid Properties” for more details.

Fluid Properties Range

Water (R-718)

The fluid properties are provided for a pressure range of 0.001 to 95 MPa, and temperature range (at 1 atmosphere) of 273.16 to 1,245.8 K.

R-134a

The fluid properties are provided for a pressure range of 0.001 to 5.5 MPa, and temperature range (at 1 atmosphere) of 177.08 to 424.4 K.

R-1234yf

The fluid properties are provided for a pressure range of 0.04 to 3.2 MPa, and temperature range (at 1 atmosphere) of 223.52 to 387.45 K.

R-404a

The fluid properties are provided for a pressure range of 0.003 to 12 MPa, and temperature range (at 1 atmosphere) of 171.6 to 550.94 K.

R-410a

The fluid properties are provided for a pressure range of 0.001 to 6 MPa, and temperature range (at 1 atmosphere) of 146.19 to 427.25 K.

R-407c

The fluid properties are provided for a pressure range of 0.001 to 6 MPa, and temperature range (at 1 atmosphere) of 158.85 to 427.92 K.

R-22

The fluid properties are provided for a pressure range of 0.001 to 8 MPa, and temperature range (at 1 atmosphere) of 120.77 to 519.49 K.

Ammonia (R-717)

The fluid properties are provided for a pressure range of 0.008 to 95 MPa, and temperature range (at 1 atmosphere) of 195.5 to 543.9 K.

CO₂ (R-744)

The fluid properties are provided for a pressure range of 0.55 to 50 MPa, and temperature range (at 1 MPa) of 216.94 to 1,389.4 K. Note that the triple point of CO₂ is higher than atmospheric pressure, and therefore the minimum valid pressure is adjusted accordingly. When using CO₂ as the working fluid, ensure that connected blocks with initial pressure parameters, such as a Reservoir (2P) block, are equal to or greater this minimum pressure.

Isobutane (R-600a)

The fluid properties are provided for a pressure range of 0.0001 to 15 MPa, and temperature range (at 1 atmosphere) of 121.02 to 516.64 K.

Visualizing Fluid Properties

To visualize the:

- Specific volume
- Specific entropy
- Temperature
- Kinematic viscosity
- Thermal conductivity
- Prandtl number

of the network fluid as a function of specific internal energy or specific enthalpy and pressure, right-click on the block and select **Fluids > Plot Fluid Properties (3D)**:

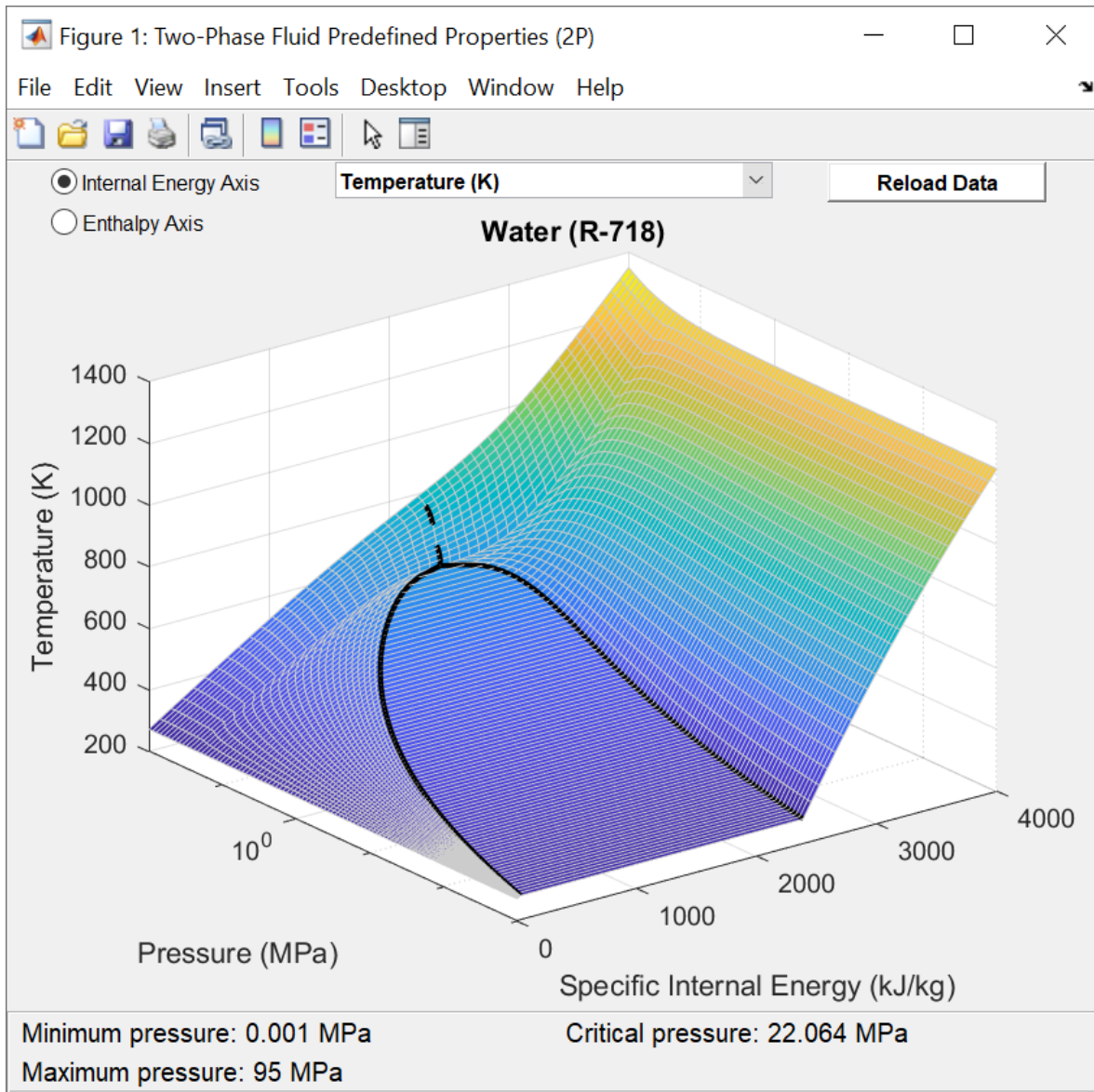

or **Fluids > Plot Fluid Properties (Contours):**

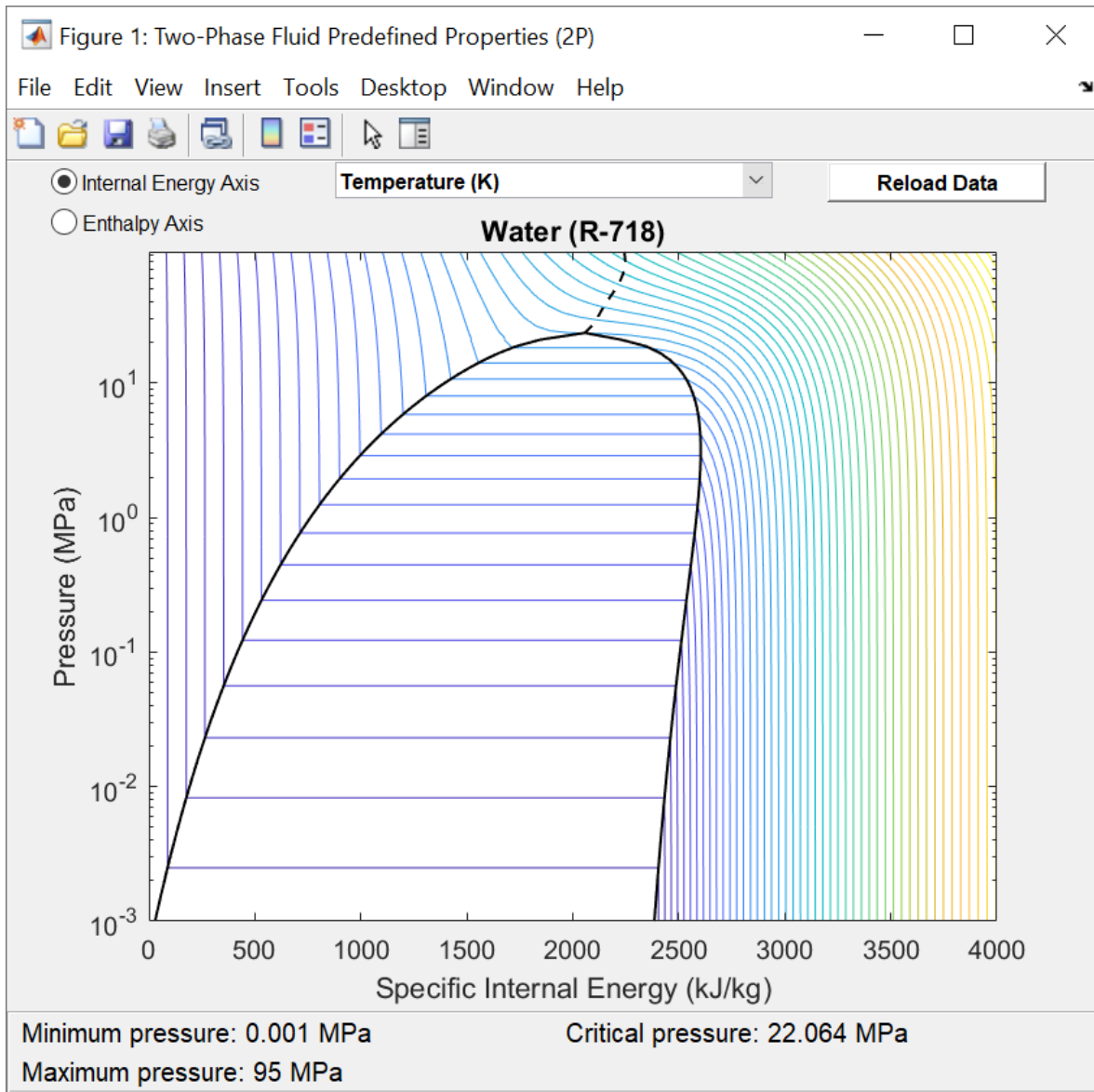

Use the **Reload Data** button to regenerate the plot whenever the fluid selection or fluid parameters change.

Ports

Conserving

A — Connection port

two-phase fluid

Two-phase fluid conserving port that connects the block to the network. This port connects to any point on a two-phase connection line within a block diagram. When you connect the Two-Phase Fluid Predefined Properties (2P) block to a network line, the fluid properties are propagated to all blocks in the circuit.

Parameters

Two-phase fluid — Working fluid

Water (R-718) (default) | R-134a | R-1234yf | R-410a blend | R-404a blend | R-407c blend | R-22 | Ammonia (R-717) | CO₂ (R-744) | Isobutane (R-600a)

Predefined working fluid options.

Atmospheric pressure — Environmental pressure

0.101325 MPa (default) | positive scalar

Environmental pressure of the system.

Dynamic pressure threshold for flow reversal — Sets region in which numerical smoothing is applied

0.01 Pa (default) | positive scalar

Sets region in which numerical smoothing is applied. A transition region is defined around 0 MPa between the positive and negative values of the **Dynamic pressure threshold for flow reversal**. Within this transition region, the calculated properties are adjusted to ensure a smooth transition.

See Also

Two-Phase Fluid Properties (2P)

Introduced in R2020b

Valve Actuator

Simplified model of valve driver



Library

Valve Actuators

Description

The Valve Actuator block represents a simplified model of a valve actuator, which is especially suitable for real-time and HIL (hardware-in-the-loop) simulation. Its functionality is similar to the 2-Position Valve Actuator and 3-Position Valve Actuator blocks, but its characterization requires fewer parameters because it is built of components that are practically linear.

The Valve Actuator block is built using the blocks from the Simscape Physical Signals library. Both the input and the output of the block are physical signals. The block diagram of the model is shown in the following figure.

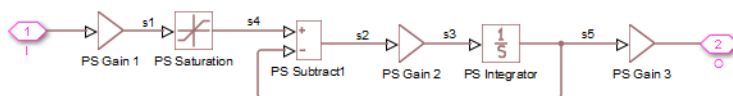

The gain of the PS Gain 1 block establishes the steady-state relationship between the input and output signals. The PS Saturation block keeps the output signal within the +/- valve stroke range. The gain of the PS Gain 2 block is $1/\text{Time constant}$, which makes it possible to reproduce the first-order lag by combining this block with the PS Subtract and PS Integrator blocks.

The transfer function of the lag is

$$H(s) = \frac{1}{Ts + 1}$$

where T is the time constant. The gain of the PS Gain 3 block is set to 1.

Note This block is constructed out of blocks from the Simscape Physical Signals library (such as PS Add, PS Gain, and so on). Currently, the blocks in the Physical Signals library do not support unit propagation and checking. For more information, see “How to Work with Physical Units”.

Dialog Box and Parameters

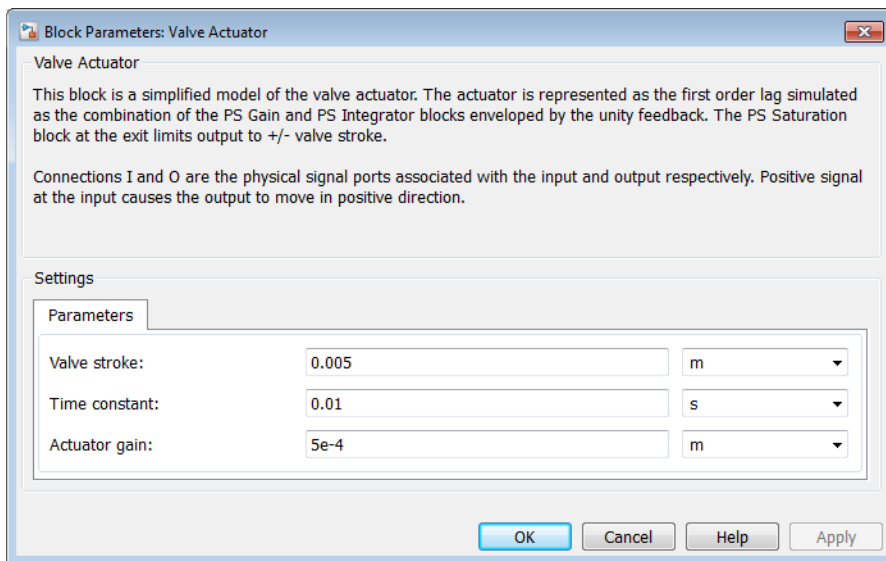

Valve stroke

The desired valve stroke, which defines the saturation level of the PS Saturation block in the actuator model. The output of the actuator is kept within the +/- valve stroke range. The default value is 0.005 m.

Time constant

Time constant of the first-order lag. The **Gain** parameter of the PS Gain 2 block is equal to $1/\text{Time constant}$. The default value is 0.01 s.

Actuator gain

Gain of the PS Gain 1 block in the block diagram of the actuator model. The default value is $5e-4$ m.

Ports

The block has one physical signal input port and one physical signal output port.

Extended Capabilities

C/C++ Code Generation

Generate C and C++ code using Simulink® Coder™.

See Also

4-Way Ideal Valve | Proportional and Servo-Valve Actuator

Introduced in R2010a

Valve Hydraulic Force

Axial hydraulic static force exerted on valve



Library

Valve Forces

Description

The Valve Hydraulic Force block simulates axial hydraulic static force exerted on a valve by fluid flowing through the orifice. The relationship between the valve opening, the pressure drop, and the force is provided as a two-dimensional table, which is processed by the PS Lookup Table (2D) block. The table can be obtained experimentally or analytically and can represent both the hydraulic static axial force and pressure forces. The force matrix must be rectangular and contain as many rows as there are pressure differential measurements and as many columns as there are valve openings. The pressure differential and opening vectors must be arranged in strictly ascending order and cover the whole range of valve operation. Connect the block in parallel with the orifice whose flow induces the force.

Connections A and B are hydraulic conserving ports that should be connected to the valve block ports in such a way as to monitor the pressure differential across the valve. Connection S is a physical signal port that provides the valve control member displacement. Connection F is a physical signal port that outputs the hydraulic axial force value. This port should be connected to the control port of an Ideal Force Source block. The pressure differential inside the block is determined as $\Delta p = p_A - p_B$. The force orientation is specified by the table values and can be positive or negative with respect to the globally assigned positive direction, depending on the value of the **Orifice orientation** parameter.

Basic Assumptions and Limitations

No transient effects can be simulated.

Dialog Box and Parameters

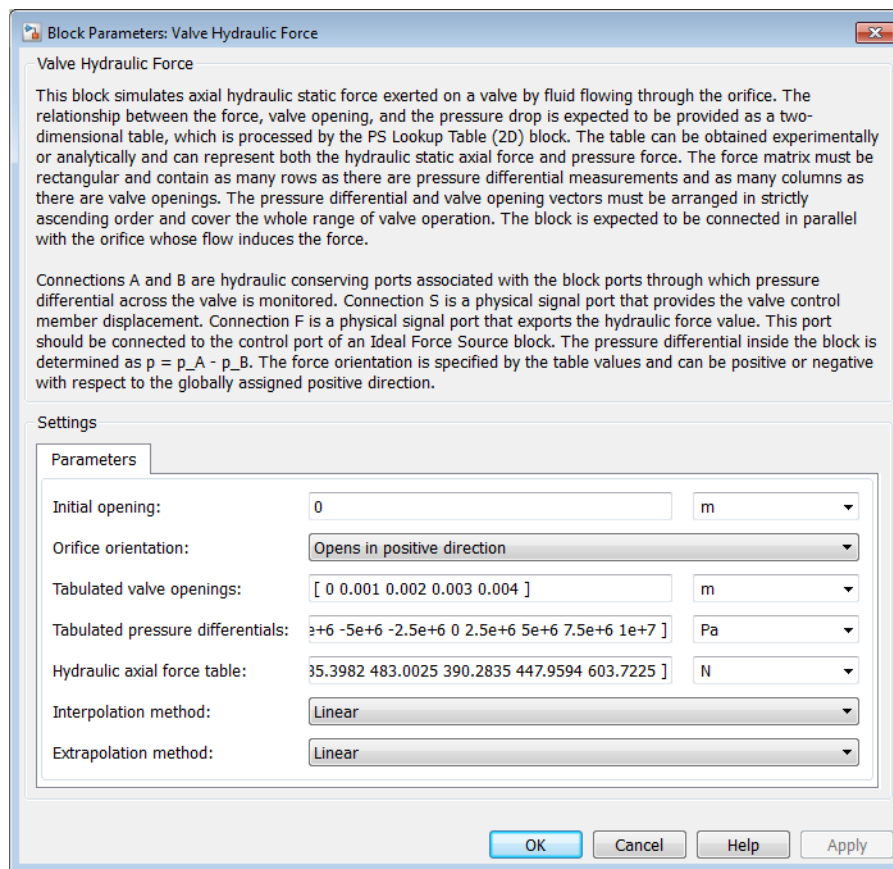

Initial opening

Orifice initial opening. The parameter can be positive (underlapped orifice), negative (overlapped orifice), or equal to zero for zero lap configuration. The default value is 0.

Orifice orientation

The parameter is introduced to specify the effect of the valve opening on the valve force. The parameter can be set to one of two options: **Opens in positive direction** or **Opens in negative direction**. The value **Opens in positive direction** specifies an orifice that opens when the valve is shifted in the globally assigned positive direction. The default value is **Opens in positive direction**.

Tabulated valve openings

Specify the vector of input values for valve openings as a one-dimensional array. The input values vector must be strictly increasing. The values can be nonuniformly spaced. The minimum number of values depends on the interpolation method: you must provide at least two values for linear interpolation, at least three values for smooth interpolation. The default values, in meters, are [0, 1e-3, 2e-3, 3e-3, 4e-3]. The **Tabulated valve openings** values will be used together with **Tabulated pressure differentials** for two-dimensional table lookup in the **Hydraulic axial force table**.

Tabulated pressure differentials

Specify the vector of input values for pressure differentials as a one-dimensional array. The vector must be strictly increasing. The values can be nonuniformly spaced. The minimum number of

values depends on the interpolation method: you must provide at least two values for linear interpolation, at least three values for smooth interpolation. The default values, in Pa, are [-100e5, -75e5, -50e5, -25e5, 0, 25e5, 50e5, 75e5, 100e5].

Hydraulic axial force table

Specify the hydraulic axial force as an m-by-n matrix, where m is the number of valve openings and n is the number of pressure differentials. Each value in the matrix specifies an axial force corresponding to a specific combination of valve opening and pressure differential. The matrix size must match the dimensions defined by the input vectors. The default values, in N, are:

```
[0, -127.3576, -27.8944, 227.2513, 575.3104; ...
0, -95.5182, -20.9208, 170.4385, 431.4828; ...
0, -63.6788, -13.9472, 113.6256, 287.6552; ...
0, -31.8394, -6.9736, 56.8128, 143.8276; ...
0, 0, 0, 0, 0; ...
196.3495, 120.7506, 97.5709, 111.9898, 150.9306; ...
392.6991, 241.5013, 195.1418, 223.9797, 301.8613; ...
589.0486, 362.2519, 292.7126, 335.9695, 452.7919; ...
785.3982, 483.0025, 390.2835, 447.9594, 603.7225]
```

Interpolation method

Select one of the following interpolation methods for approximating the output value when the input value is between two consecutive grid points:

- **Linear** — Select this option to get the best performance.
- **Smooth** — Select this option to produce a continuous surface with continuous first-order derivatives.

For more information on interpolation algorithms, see the PS Lookup Table (2D) block reference page.

Extrapolation method

Select one of the following extrapolation methods for determining the output value when the input value is outside the range specified in the argument list:

- **Linear** — Select this option to produce a surface with continuous first-order derivatives in the extrapolation region and at the boundary with the interpolation region.
- **Nearest** — Select this option to produce an extrapolation that does not go above the highest point in the data or below the lowest point in the data.

For more information on extrapolation algorithms, see the PS Lookup Table (2D) block reference page.

Restricted Parameters

When your model is in Restricted editing mode, you cannot modify the following parameters:

- **Orifice orientation**
- **Interpolation method**
- **Extrapolation method**

All other block parameters are available for modification.

Ports

The block has the following ports:

A

Hydraulic conserving port associated with a valve port.

B

Hydraulic conserving port associated with another valve port to monitor the pressure differential.

S

Physical signal port that provides the valve control member displacement.

F

Physical signal port that outputs hydraulic axial force.

Examples

The following example shows a model of a poppet valve built of a Poppet Valve block and a Valve Hydraulic Force block. The Valve Hydraulic Force block is connected in parallel and provides tabulated data to compute hydraulic force acting on the valve. The force value is exported through the F port.

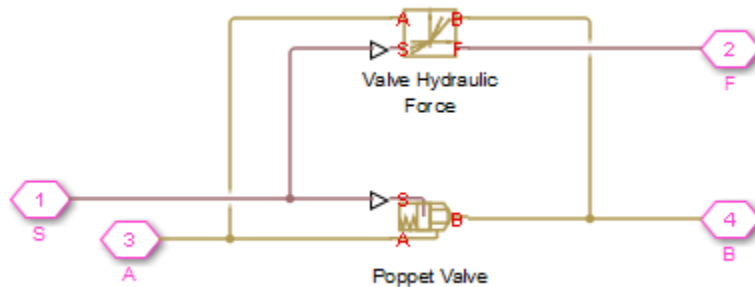

Extended Capabilities

C/C++ Code Generation

Generate C and C++ code using Simulink® Coder™.

See Also

Spool Orifice Hydraulic Force

Topics

“Upgrading Simscape Fluids Models Containing Hydraulics (Isothermal) Blocks”

Introduced in R2007a

Valve Plate Orifice (IL)

Variable orifice in an isothermal axial-piston machine

Library: Simscape / Fluids / Isothermal Liquid / Pumps & Motors / Auxiliary Components



Description

The Valve Plate Orifice (IL) block models a crescent-shaped opening between moving pistons and a pump in an axial-piston machine. The rotating pistons periodically connect to the pump intake or discharge through the orifice plate. You can connect two valve plate blocks to each cylinder of an axial-piston pump to represent both the pump inlet and outlet slots.

A rotating cylinder, with one crescent slot, is connected to the pump intake at port **A** and pump discharge at port **B**. These points are connected to the plate between the **Pressure carryover angle** and π radians (180 degrees) from each other. The plate rotation angle is set by the signal at port **G**. The cylinder position angle, γ , is the sum of the position signal, G , and the initial angle offset, the **Phase angle**, γ_0 :

$$\gamma = \gamma_0 + G.$$

γ is always between 0 and 2π . For any combined signal and offset larger than 2π rad, γ is maintained at 2π , and for any combined signal and offset lower than 0 rad, γ is maintained at 0. To change the initial position of the orifice relative to the slot, you can adjust the **Phase angle** parameter.

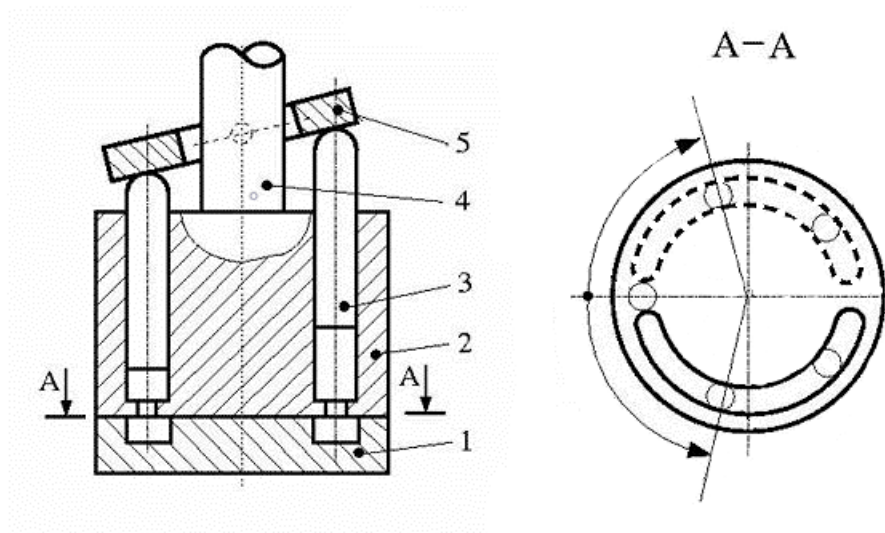

Axial-Piston Machine With Five Pistons

The numbers in the diagram indicate the components of an axial-piston machine:

- 1 Valve plate orifice
- 2 Rotor
- 3 Piston
- 4 Driving shaft
- 5 Swash plate

Cylinder Angle

The cylinder rotational alignment with the slot is described by the following angles:

- Cylinder angle at rotation onto slot, γ_1 :

$$\gamma_1 = \Psi - \frac{r}{R}$$

- Cylinder angle at complete rotation onto slot, γ_2 :

$$\gamma_2 = \Psi + \frac{r}{R}$$

- Cylinder angle at rotation beyond slot, γ_3 :

$$\gamma_3 = \pi - 2\frac{r}{R}$$

- Cylinder angle at complete rotation beyond slot, γ_4 :

$$\gamma_4 = \pi$$

where:

- Ψ is the **Pressure carryover angle**. This angle represents the average angular distance the piston travels during its pressure transition period from a closed to opened slot.
- r is the half of the **Cylinder orifice diameter**.
- R is the **Cylinder block pitch radius**.

Orifice Opening Area

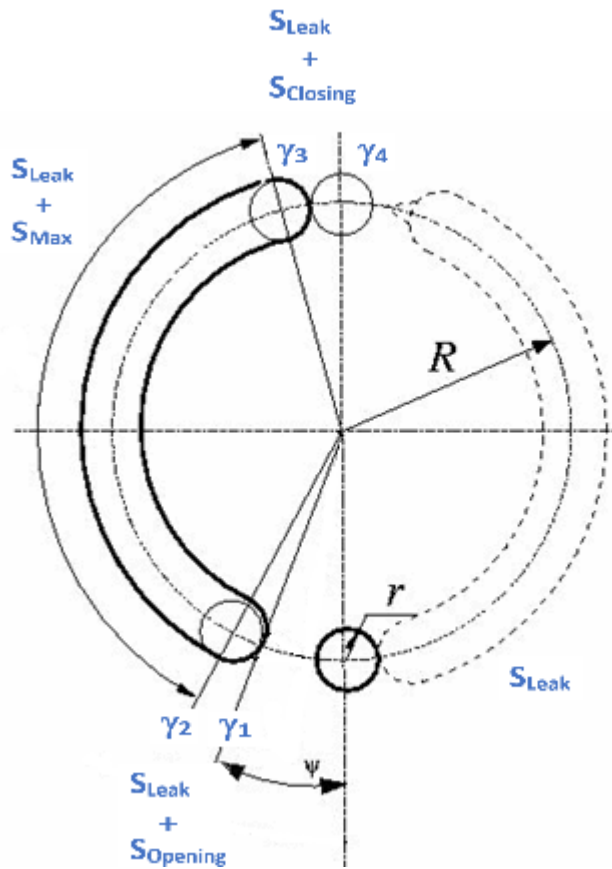

Orifice area calculations during cylinder motion

The transition opening area, which is the opening between the cylinder rotation angles γ_1 and γ_2 , is calculated as:

$$A_{\gamma_1\gamma_2} = S_{opening} + S_{Leak} = r^2(2\beta_{opening} - \sin(2\beta_{opening})) + S_{Leak}.$$

The transition closing area, which is the opening between the cylinder rotation angles γ_3 and γ_4 , is calculated as:

$$A_{\gamma_3\gamma_4} = S_{closing} + S_{Leak} = r^2(2\beta_{closing} - \sin(2\beta_{closing})) + S_{Leak},$$

where the opening and closing parameters are:

$$\beta_{opening} = \cos^{-1}\left(\frac{R}{r}\sin\left(\frac{(\psi + \frac{r}{R}) - \gamma}{2}\right)\right),$$

and

$$\beta_{closing} = \cos^{-1}\left(\frac{R}{r}\sin\left(\frac{\gamma - (\pi - 2\frac{r}{R})}{2}\right)\right).$$

The area between γ_2 and γ_3 is $A_{\gamma_2\gamma_3} = S_{Max} + S_{Leak}$, and the area between γ_4 and γ_1 is $A_{\gamma_4\gamma_1} = S_{Leak}$.
The maximum opening of the orifice is $S_{Max} = \pi r^2$.

A nonzero **Smoothing factor** can provide additional numerical stability when the orifice is in near-closed or near-open position.

Numerically-Smoothed Orifice Angle

At the orifice slot entrance and exit angles, you can maintain numerical robustness in your simulation by adjusting the block **Smoothing factor**. A smoothing function is applied to all calculated angles, but primarily influences the simulation at the extremes of this range.

The normalized transition opening angle is calculated as:

$$\widehat{\gamma}_{open} = \frac{\gamma}{(\gamma_2 - \gamma_1)}.$$

The **Smoothing factor**, s , is applied to the normalized angle:

$$\widehat{\gamma}_{open, smoothed} = \frac{1}{2} + \frac{1}{2} \sqrt{\widehat{\gamma}_{open}^2 + \left(\frac{s}{4}\right)^2} - \frac{1}{2} \sqrt{(\widehat{\gamma}_{open} - 1)^2 + \left(\frac{s}{4}\right)^2}.$$

The smoothed transition opening angle is:

$$\gamma_{open, smoothed} = \widehat{\gamma}_{open, smoothed} (\gamma_2 - \gamma_1).$$

Similarly, the normalized transition closing angle is:

$$\widehat{\gamma}_{close} = \frac{\gamma}{(\gamma_4 - \gamma_3)}.$$

The **Smoothing factor**, s , is applied to the normalized angle:

$$\widehat{\gamma}_{close, smoothed} = \frac{1}{2} + \frac{1}{2} \sqrt{\widehat{\gamma}_{close}^2 + \left(\frac{s}{4}\right)^2} - \frac{1}{2} \sqrt{(\widehat{\gamma}_{close} - 1)^2 + \left(\frac{s}{4}\right)^2}.$$

The smoothed transition closing angle is:

$$\gamma_{close, smoothed} = \widehat{\gamma}_{close, smoothed} (\gamma_4 - \gamma_3)$$

Mass Flow Rate Equation

The flow through a valve plate orifice is calculated from the pressure-area relationship:

$$\dot{m} = C_d A_{orifice} \sqrt{2\bar{\rho}} \frac{\Delta p}{[\Delta p^2 + \Delta p_{crit}^2]^{1/4}},$$

where:

- C_d is the **Discharge coefficient**.
- $A_{orifice}$ is the area open to flow.
- $\bar{\rho}$ is the average fluid density.
- Δp is the pressure drop over the valve, $P_A - P_B$.

The critical pressure difference, Δp_{crit} , is the pressure differential associated with the **Critical Reynolds number**, Re_{crit} , which is the point of transition between laminar and turbulent flow in the fluid:

$$\Delta p_{crit} = \frac{\pi \bar{\rho}}{8 A_{orifice}} \left(\frac{\nu Re_{crit}}{C_d} \right)^2.$$

Ports

Conserving

A – Liquid port

isothermal liquid

Entry point to the orifice.

B – Liquid port

isothermal liquid

Exit point from the orifice.

Input

G – Cylinder rotation angle, rad

physical signal

Cylinder rotation angle in radians, specified as a physical signal..

Parameters

Cylinder block pitch radius – Cylinder pitch radius

0.05 m (default) | positive scalar

Pitch radius of the rotating cylinder.

Cylinder orifice diameter – Diameter of the cylinder slot

2.5e-3 m (default) | positive scalar

Diameter of the cylinder slot.

Pressure carryover angle – Pressure transition distance

0.06 rad (default) | scalar

Average angular distance the piston travels during the pressure transition period from a closed to opening slot.

Phase angle – Initial plate offset angle

0 rad (default) | scalar

Initial plate offset angle. The total angle between the plate and slot is the sum of the **Phase angle** and the **Pressure carryover angle**, Ψ .

Leakage area – Gap area when in fully closed position

1e-10 m² (default) | positive scalar

Sum of all gaps when the valve is in a fully closed position. Any area smaller than this value is maintained at the specified leakage area. This contributes to numerical stability by maintaining continuity in the flow.

Discharge coefficient – Discharge coefficient

0.64 (default) | positive scalar

Correction factor that accounts for discharge losses in theoretical flows.

Critical Reynolds number – Upper Reynolds number limit for laminar flow

150 (default) | positive scalar

Upper Reynolds number limit for laminar flow through the orifice.

Smoothing factor – Numerical smoothing factor

0.01 (default) | positive scalar in the range [0,1]

Continuous smoothing factor that introduces a layer of gradual change to the flow response when the valve is in near-open or near-closed positions. Set this value to a nonzero value less than one to increase the stability of your simulation in these regimes.

See Also

Swash Plate

Introduced in R2020a

Variable Area Orifice (TL)

Local flow restriction with a variable cross-sectional area

Library: Simscape / Fluids / Thermal Liquid / Valves & Orifices



Description

The Variable Area Orifice (TL) block models the flow through a local restriction with variable opening area. The orifice contains a control member—such as a ball, spool, or diaphragm—which determines by its displacement the instantaneous opening area. Elements such as this are characteristic of valves and are, in the Thermal Liquid library, the foundation upon which all directional valve blocks are based. See, for example, the 2-Way Directional Valve (TL) block. Use this block to create a custom component with variable orifices if such is not provided in the Thermal Liquid library.

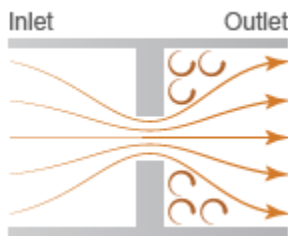

The orifice is assumed to consist of a contraction followed by a sudden expansion in flow area. The contraction causes the flow rate to rise and the pressure to drop. The expansion allows the pressure to recover, though only in part: past the vena contracta, where the flow is at its narrowest, the flow generally separates from the wall, causing it to lose some energy. The extent of the pressure recovery depends on the discharge coefficient of the orifice and on the ratio of the orifice and port areas. Set the **Pressure recovery** to *Off* to ignore this effect if necessary.

The effect that the motion of the control member has on the opening area of the orifice depends on the setting of the **Opening orientation** block parameter. In the default setting of *Positive*, the orifice (if within its opening range) opens when the control member moves in the positive direction. In the alternate setting of *Negative*, the orifice opens with motion in the negative direction.

Orifice Positions

The orifice is continuously variable. It shifts smoothly between positions, of which it has two. One—the *normal* position—is that to which the orifice reverts when its control signal falls to zero. Unless a control member offset has been specified, the **A-B** orifice is always fully closed in this position. Another—the *working* position—is that to which the orifice moves when its control signal rises to a maximum. The orifice is generally fully open in this position. Note that whether the orifice is in fact open and how open it is both depend on the value of the control member offset.

Orifice Opening

Which position the orifice is in depends on the control member coordinate—a length that, in the valve blocks based on this orifice model, is often referred to as the *orifice opening*. This variable is calculated during simulation from the control member offset, specified via the block parameter of the

same name, and from the control member displacement, a variable obtained from the physical signal specified at port **S**:

$$h = h_0 + \delta x,$$

where:

- h is the **A-B** orifice opening.
- h_0 is the **A-B** opening offset.
- δ is the orifice orientation, +1 if **Positive**, -1 if **Negative**.
- x is the control member displacement.

A control member displacement of zero corresponds to a valve that is in its normal position. The orifice begins to open when the orifice opening (h) rises above zero and it continues to open until the orifice opening is at a maximum value. This maximum is obtained from the **Maximum control displacement** block parameter, in the linear orifice parameterization, or from the specified data vectors, in the tabulated orifice parameterizations.

Opening Offsets

The orifice is by default configured so that it is fully closed when the control member displacement is zero. Such an orifice, when it represents a valve, is often described as being zero-lapped. It is possible, by applying an offset to the control member, to model an orifice that is *underlapped*—that is, partially open when in the normal position. The orifice can also be *overlapped*—fully closed over a range of control member displacements extending past the normal closed position.

The figure graphs the orifice opening— $h(x)$ —in the cases of zero-lapped (**I**), underlapped (**II**), and overlapped (**III**) orifices. The opening offset— h_{s_0} —is zero in the first case, greater than zero in the second, and smaller than zero in the third. The control member must move right of its normal position (in the positive direction along the x -axis) for the overlapped orifice to crack open; it must move left of its normal position for the underlapped orifice to shut tight.

I.

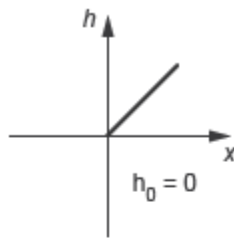

II.

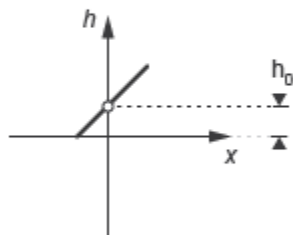

III.

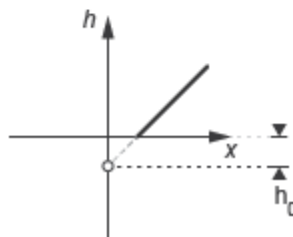

Opening Characteristics

The orifice opening serves during simulation to calculate the mass flow rate through the orifice. The calculation can be a direct mapping from opening to flow rate or an indirect conversion, first from opening to orifice area and then from orifice area to mass flow rate. The calculation, and the data required for it, depend on the setting of the **Valve parameterization** block parameter:

- **Linear area-opening relationship** — Calculate the valve opening area from the control member position and from it obtain the mass flow rate through the valve. The opening area is assumed to vary linearly with the control member position. The slope of the linear expression is determined from the **Maximum valve opening** and **Maximum opening area** block parameters:

$$S_{\text{Lin}} = \frac{S_{\text{Max}}}{h_{\text{Max}}}h,$$

where S_{Lin} is the linear form of the opening area, S_{Max} is the value of the **Maximum orifice area** block parameter, h_{Max} is the value of the **Maximum control displacement** block parameter. This expression is reformulated as a piecewise conditional expression so as to saturate the opening area at a small leakage value and ensure that transitions to the normal and working positions are smooth.

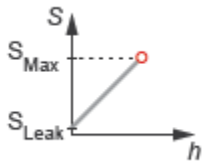

- **Tabulated data - Area vs. opening** — Calculate the valve opening area from the control member position and from it obtain the mass flow rate through the valve. The opening area can vary nonlinearly with the control member position. The relationship between the two is given by the tabulated data in the **Valve opening vector** and **Opening area vector** block parameters:

$$S_{\text{Tab}} = S(h),$$

where S_{Tab} is the tabulated form of the opening area, a function of the orifice opening, h .

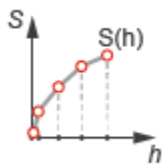

- **Tabulated data - Mass flow rate vs. opening and pressure drop** — Calculate the mass flow rate directly from the control member position and the pressure drop across the valve. The relationship between the three variables can be nonlinear and it is given by the tabulated data in the **Valve opening vector**, **Pressure drop vector**, and **Mass flow rate table** block parameters:

$$\dot{m}_{\text{Tab}} = \frac{\rho_{\text{Ref}}}{\rho_{\text{Avg}}} \dot{m}(h, \Delta p),$$

where \dot{m} is the tabulated form of the mass flow rate, a function of the orifice opening, h , and of the pressure drop across the orifice, Δp . The mass flow rate is adjusted for temperature and pressure by the ratio $\rho_{\text{Ref}}/\rho_{\text{Avg}}$, where ρ is the fluid density at some reference temperature and pressure (subscript Ref) or at the averages of those variables within the orifice.

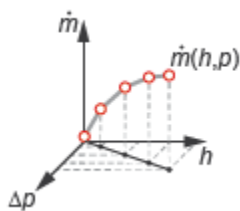

Numerical Smoothing

To ensure adequate simulation performance, the orifice opening area is smoothed over two small regions of the orifice opening, one near the fully closed state, the other near the fully open state. The smoothing is accomplished by means of polynomial expressions (to be incorporated into the final form of the opening area expression):

$$\lambda_{\text{Min}} = 3\Delta h_{\text{Min}}^* - 2\Delta h_{\text{Min}}^{*3} \quad \text{and} \quad \lambda_{\text{Max}} = 3\Delta h_{\text{Max}}^* - 2\Delta h_{\text{Max}}^{*3},$$

where λ is the smoothing factor applied at the minimum (subscript Min) and maximum (subscript Max) portions of the opening area expression. The smoothing factors are calculated as:

$$\Delta h_{\text{Min}} = \frac{h - h_{\text{Min}}}{\Delta h_{\text{Smooth}}} \quad \text{and} \quad \Delta h_{\text{Max}} = \frac{h - (h_{\text{Max}} - \Delta h_{\text{Smooth}})}{\Delta h_{\text{Smooth}}},$$

where h_{Min} is the minimum orifice opening and Δh_{Smooth} is the range of orifice openings over which to smooth the linear form of the opening area. The value of S_{Min} is calculated as:

$$h_{\text{Min}} = h_{\text{Max}} \frac{S_{\text{Leak}}}{S_{\text{Max}}},$$

where S_{Leak} is the value of the **Leakage area** block parameter. The value of S_{Smooth} is calculated as:

$$\Delta h_{\text{Smooth}} = f_{\text{Smooth}} \frac{h_{\text{Max}} - h_{\text{Min}}}{2},$$

where f_{Smooth} is the value of the **Smoothing factor** block parameter—a fraction between 0 and 1, with 0 indicating zero smoothing and 1 maximum smoothing. The final, smoothed, orifice opening area is given by the piecewise expression:

$$S_{\text{Smooth}} = \begin{cases} S_{\text{Leak}}, & \text{if } h \leq h_{\text{Min}} \\ S_{\text{Leak}}(1 - \lambda_{\text{Min}}) + S_{\text{Leak}}\lambda_{\text{Min}}, & \text{if } h < h_{\text{Min}} + \Delta h_{\text{Smooth}} \\ S_{\text{Lin}}, & \text{if } h \leq h_{\text{Max}} - \Delta h_{\text{Smooth}} \\ S_{\text{Lin}}(1 - \lambda_{\text{Max}}) + S_{\text{Max}}\lambda_{\text{Max}}, & \text{if } h < h_{\text{Max}} \\ S_{\text{Max}}, & \text{if } h \geq h_{\text{Max}} \end{cases}$$

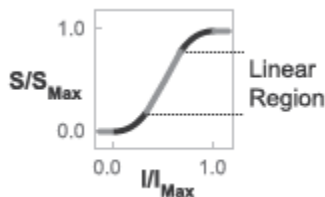

Orifice Area Smoothing

Leakage Flow

The primary purpose of the leakage flow rate of a closed orifice is to ensure that at no time a portion of the thermal liquid network becomes isolated from the remainder of the model. Such isolated portions reduce the numerical robustness of the model and can slow down simulation or cause it to fail. Leakage flow is generally present in real orifices but in a model its exact value is less important than its being a small number greater than zero. The leakage flow rate is determined from the **Leakage area** block parameter.

Mass Balance

The volume of fluid inside the orifice, and therefore the mass of the same, is assumed to be very small and it is, for modeling purposes, ignored. As a result, no amount of fluid can accumulate there. By the principle of conservation of mass, the mass flow rate into the orifice through one port must therefore equal that out of the orifice through the other port:

$$\dot{m}_A + \dot{m}_B = 0,$$

where \dot{m} is defined as the mass flow rate *into* the orifice through the port indicated by the subscript (**A** or **B**).

Momentum Balance

The causes of the pressure losses incurred in the orifice are ignored in the block. Whatever their natures—sudden area changes, flow passage contortions—only their cumulative effect is considered during simulation. This effect is captured in the block by the discharge coefficient, a measure of the mass flow rate through the orifice relative to the theoretical value that it would have in an ideal orifice. Expressing the momentum balance in the orifice in terms of the pressure drop induced in the flow:

$$p_A - p_B = \frac{\dot{m}_{\text{Avg}} \sqrt{\dot{m}_{\text{Avg}}^2 + \dot{m}_{\text{Crit}}^2}}{2\rho_{\text{Avg}} C_D S_{\text{Smooth}}^2} \left[1 - \left(\frac{S_{\text{Smooth}}}{S_{\text{Lin}}} \right)^2 \right] \xi_p,$$

where C_D is the discharge coefficient, and ξ_p is the pressure drop ratio—a measure of the effect impressed by the pressure recovery that in real orifices occurs between the vena contracta (the point at which the flow is at its narrowest) and the outlet, assumed to be a small distance away. The subscript *Avg* denotes an average of the values at the thermal liquid ports. The critical mass flow rate \dot{m}_{Crit} is calculated from the critical Reynolds number—that at which the flow in the orifice is assumed to transition from laminar to turbulent:

$$\dot{m}_{\text{Crit}} = \text{Re}_{\text{Crit}} \mu_{\text{Avg}} \sqrt{\frac{\pi}{4} S_{\text{Lin}}},$$

where μ denotes dynamic viscosity. The value of the pressure ratio depends on the setting of the **Pressure recovery** block parameter. In the default setting of **Off**:

$$\xi_p = 1.$$

If **On** is selected instead:

$$\xi_p = \frac{\sqrt{1 - \left(\frac{S_{\text{Smooth}}}{S_{\text{Lin}}} \right)^2 (1 - C_D^2)} - C_D \frac{S_{\text{Smooth}}}{S_{\text{Lin}}}}{\sqrt{1 - \left(\frac{S_{\text{Smooth}}}{S_{\text{Lin}}} \right)^2 (1 - C_D^2)} + C_D \frac{S_{\text{Smooth}}}{S_{\text{Lin}}}}.$$

Energy Balance

The orifice is modeled as an adiabatic component. No heat exchange can occur between the fluid and the wall that surrounds it. No work is done on or by the fluid as it traverses from inlet to outlet. With these assumptions, energy can flow by advection only, through ports **A** and **B**. By the principle of conservation of energy, the sum of the port energy flows must always equal zero:

$$\phi_A + \phi_B = 0,$$

where ϕ is defined as the energy flow rate *into* the orifice through one of the ports (**A** or **B**).

Ports

Input

S — Control member displacement, unitless

physical signal

Instantaneous displacement of the valve control member.

Conserving

A — Flow passage

thermal liquid

Opening through which the flow can enter or exit the valve.

B — Flow passage

thermal liquid

Opening through which the flow can enter or exit the valve.

Parameters

Orifice parameterization — Method by which to model the opening characteristics of the orifice

Linear area-opening relationship (default) | Tabulated data - Area vs. opening |
Tabulated data - Mass flow rate vs. opening and pressure drop

Method by which to model the opening characteristics of the orifice. The default setting prescribes a linear relationship between the orifice opening area and the orifice opening. The alternative settings allow for a general, nonlinear relationship to be specified in tabulated form, in one case between the opening area and the orifice opening, in the other case between the mass flow rate and both the orifice opening and the pressure drop between the ports.

Maximum valve opening — Orifice opening at which the opening area is at a maximum

5e-3 m (default) | positive scalar in units of length

Orifice opening at which the orifice is fully open and its opening area is therefore at a maximum. This parameter is used to calculate the slope of the linear expression relating the opening area to the orifice opening.

Dependencies

This parameter is active when the **Orifice parameterization** block parameter is set to Linear area-opening relationship.

Maximum orifice area — Opening area of the orifice in the fully open position

1e-4 m² (default) | positive scalar in units of area

Opening area of the orifice in the fully open position, when the orifice opening is that specified in the **maximum valve opening** block parameter. This parameter is used to calculate the slope of the linear expression relating the opening area to the orifice opening.

Dependencies

This parameter is active when the **Orifice parameterization** block parameter is set to Linear area-opening relationship.

Leakage area — Opening area of the orifice in the maximally closed position

1e-10 m² (default) | positive scalar in units of area

Opening area of the orifice in the fully closed position, when only internal leakage between its ports remains. This parameter serves primarily to ensure that closure of the orifice does not cause portions of the thermal liquid network to become isolated. The exact value specified here is less important than its being a small number greater than zero.

Dependencies

This parameter is active when the **Orifice parameterization** block parameter is set to Linear area-opening relationship.

Smoothing factor — Measure of the amount of smoothing to apply to the opening area function

0.01 (default) | positive unitless scalar

Measure of the amount of smoothing to apply to the opening area function. This parameter determines the widths of the regions to be smoothed, one being at the fully open position, the other at the fully closed position. The smoothing superposes on the linear opening area function two nonlinear segments, one for each region of smoothing. The greater the value specified, the greater the smoothing and the broader the nonlinear segments.

Dependencies

This parameter is active when the **Orifice parameterization** block parameter is set to Linear area-opening relationship.

Opening vector — Vector of orifice openings at which to tabulate the orifice opening areas

[-0.002, 0, 0.002, 0.005, 0.015] m (default) | vector of positive numbers in units of length

Vector of orifice openings at which to specify—dependent on the valve parameterization—the opening area of the orifice or its mass flow rate. The vector elements must increase monotonically from left to right. This vector must be equal in size to that specified in the **Opening area vector** block parameter or to the number of rows in the **Mass flow rate table** block parameter.

This data serves to construct a one-way lookup table by which to determine, from the orifice opening, the opening area of the orifice or a two-way lookup table by which to determine, from the orifice opening and pressure drop, the mass flow rate of the orifice. Data is handled with linear interpolation (within the tabulated data range) and nearest-neighbor extrapolation (outside of the data range).

Dependencies

This parameter is active when the **Orifice parameterization** block parameter is set to Tabulated data - Area vs. opening.

Opening area vector — Vector of opening areas at the specified orifice opening breakpoints

[1e-09, 2.0352e-07, 4.0736e-05, 0.00011438, 0.00034356] m² (default) | vector of positive numbers in units of area

Vector of opening areas corresponding to the breakpoints defined in the **Opening vector** block parameter. The vector elements must increase monotonically from left to right (with increasing values of the orifice opening). This vector must be equal in size to the number of orifice opening breakpoints.

This data serves to construct a one-way lookup table by which to determine from the orifice opening the opening area of the orifice. Data is handled with linear interpolation (within the tabulated data range) and nearest-neighbor extrapolation (outside of the data range).

Dependencies

This parameter is active when the **Orifice parameterization** block parameter is set to Tabulated data - Area vs. opening.

Pressure drop vector — Vector of pressure drops at which to tabulate the mass flow rates

[-0.1, 0.3, 0.5, 0.7] MPa (default) | vector in units of pressure

Vector of pressure differentials from port **A** to port **B** at which to specify the mass flow rate of the orifice. The vector elements must increase monotonically from left to right. This vector must be equal in size to the number of columns in the **Mass flow rate table** block parameter.

This data serves to construct a two-way lookup table by which to determine, from the orifice opening and pressure drop, the opening area of the orifice. Data is handled with linear interpolation (within the tabulated data range) and nearest-neighbor extrapolation (outside of the data range).

Dependencies

This parameter is active when the **Orifice parameterization** block parameter is set to Tabulated data - Mass flow rate vs. opening and pressure drop.

Mass flow rate table — Matrix of mass flow rates at the specified orifice opening and pressure drop breakpoints

[-1e-05, 1.7e-05, 2e-05, 2.6e-05; -.002, .0035, .0045, .0053; -.4, .7, .9, 1.06; -1.13, 1.96, 2.5, 3; -3.45, 6, 7.7, 9.13] kg/s (default) | matrix in units of mass/time

Matrix of mass flow rates corresponding to the breakpoints defined in the **Opening vector** and **Pressure drop vector** block parameters. The orifice opening increases from row to row from top to bottom. The pressure drop increases from column to column from left to right. The mass flow rate must increase monotonically in the same directions (with increasing control member position and increasing pressure drop).

This data serves to construct a two-way lookup table by which to determine, from the orifice opening and pressure drop, the opening area of the orifice. Data is handled with linear interpolation (within the tabulated data range) and nearest-neighbor extrapolation (outside of the data range). Ensure that the number of rows is equal to the size of the **Opening area vector** block parameter and that the number of columns is equal to the size of the **Pressure drop vector** block parameter.

Dependencies

This parameter is active when the **Orifice parameterization** block parameter is set to Tabulated data - Mass flow rate vs. opening and pressure drop.

Reference inflow temperature — Inlet temperature at which to specify the tabulated data

293.15 K (default) | positive scalar in units of temperature

Nominal inlet temperature, with reference to absolute zero, at which to specify the tabulated data. This parameter is used to adjust the mass flow rate according to the temperature measured during simulation.

Dependencies

This parameter is active when the **Orifice parameterization** block parameter is set to Tabulated data - Mass flow rate vs. opening and pressure drop.

Reference inflow pressure — Inlet pressure at which to specify the tabulated data

0.101325 MPa (default) | positive scalar in units of pressure

Nominal inlet pressure, with reference to absolute zero, at which to specify the tabulated data. This parameter is used to adjust the mass flow rate according to the pressure measured during simulation.

Dependencies

This parameter is active when the **Orifice parameterization** block parameter is set to Tabulated data - Mass flow rate vs. opening and pressure drop.

Control member offset — Distance by which to displace the control member in the normal orifice position

0 m (default) | positive scalar in units of length

Offset between the control member and the location at which, in the normal orifice position, it would completely cover the orifice. Specify a positive offset to model an underlapped orifice or a negative offset to model an overlapped orifice. For detail on how the opening offsets impact the block calculations, see the block description.

Cross-sectional area at ports A and B — Flow area at the thermal liquid ports

0.01 m (default) | positive scalar in units of area

Area normal to the flow path at each port. The ports are assumed to be equal in size. The flow area specified here should match those of the inlets of those components to which the orifice connects.

Characteristic longitudinal length — Measure of the length of the flow path through the orifice

0.1 (default) | positive scalar in units of length

Average distance traversed by the fluid as it moves from inlet to outlet. This distance is used in the calculation of the internal thermal conduction that occurs between the two ports (as part of the smoothed upwind energy scheme employed in the thermal liquid domain).

Discharge coefficient — Empirical factor defined as the ratio of actual to ideal mass flow rates

0.7 (default) | positive unitless scalar

Ratio of the actual flow rate through the orifice to the theoretical value that it would have in an ideal valve. This semi-empirical parameter measures the flow allowed through the orifice: the greater its value, the greater the flow rate. Refer to the valve data sheet, if available, for this parameter.

Critical Reynolds number — Reynolds number at the boundary between laminar and turbulent flow regimes

12 (default) | positive unitless scalar

Reynolds number at which the flow is assumed to transition between laminar and turbulent regimes.

References

[1] *Measurement of fluid flow by means of pressure differential devices inserted in circular cross-section conduits running full — Part 2: Orifice plates (ISO 5167-2:2003)*. 2003.

Extended Capabilities

C/C++ Code Generation

Generate C and C++ code using Simulink® Coder™.

See Also

2-Way Directional Valve (TL) | 3-Way Directional Valve (TL) | 4-Way Directional Valve (TL) | Check Valve (TL)

Introduced in R2016a

Variable Orifice

Generic hydraulic variable orifice



Library

Orifices

Description

The block represents a variable orifice of any type as a data-sheet-based model. Depending on data listed in the manufacturer's catalogs or data sheets for your particular orifice, you can choose one of the following model parameterization options:

- **By maximum area and opening** — Use this option if the data sheet provides only the orifice maximum area and the control member maximum stroke.
- **By area vs. opening table** — Use this option if the catalog or data sheet provides a table of the orifice passage area based on the control member displacement $A=A(h)$.
- **By pressure-flow characteristic** — Use this option if the catalog or data sheet provides a two-dimensional table of the pressure-flow characteristics $q=q(p, h)$.

In the first case, the passage area is assumed to be linearly dependent on the control member displacement, that is, the orifice is assumed to be closed at the initial position of the control member (zero displacement), and the maximum opening takes place at the maximum displacement. In the second case, the passage area is determined by one-dimensional interpolation from the table $A=A(h)$. In both cases, a small leakage area is assumed to exist even after the orifice is completely closed. Physically, it represents a possible clearance in the closed valve, but the main purpose of the parameter is to maintain numerical integrity of the circuit by preventing a portion of the system from getting isolated after the valve is completely closed. An isolated or “hanging” part of the system could affect computational efficiency and even cause failure of computation.

In the first and second cases, the flow rate is computed according to the following equations:

$$q = C_D \cdot A(h) \sqrt{\frac{2}{\rho} \frac{\Delta p}{(\Delta p^2 + p_{Cr}^2)^{1/4}}}$$

$$\Delta p = p_A - p_B,$$

$$h = x_0 + x \cdot or$$

For the first parameterization, the opening area (A) is a piecewise function of the control member position (h). The area saturates at its leakage value when the control member is in the fully closed position (h_{min}). It saturates at its maximum value when the control member is in the fully open position (h_{max}).

$$A(h) = \begin{cases} A_{\text{leak}} & h \leq h_{\text{min}} \\ \frac{A_{\text{max}}}{h_{\text{max}}}h, & h > 0 \\ A_{\text{max}}, & h \geq h_{\text{max}} \end{cases}$$

The minimum control member position is calculated as:

$$h_{\text{min}} = \frac{h_{\text{max}}}{A_{\text{max}}}A_{\text{leak}}$$

For the second parameterization, the opening area is a tabulated function of control member displacement. As with the linear parameterization, the area saturates at its leakage value when the control member is in the fully closed position, and it saturates at its maximum value when the control member is in the fully open position. Between the closed and open positions:

$$A = f(h)$$

The table summarizes the parameters used in the equations.

q	Flow rate
p	Pressure differential
p_A, p_B	Gauge pressures at the block terminals
C_D	Flow discharge coefficient
$A(h)$	Instantaneous orifice passage area
A_{max}	Orifice maximum area
h_{max}	Control member maximum displacement
x_0	Initial opening
x	Control member displacement from initial position
h	Orifice opening
or	Orifice orientation indicator. The variable assumes +1 value if the control member displacement in the globally assigned positive direction opens the orifice, and -1 if positive motion decreases the opening.
ρ	Fluid density
A_{leak}	Closed orifice leakage area
p_{cr}	Minimum pressure for turbulent flow

The minimum pressure for turbulent flow, p_{cr} , is calculated according to the laminar transition specification method:

- By pressure ratio — The transition from laminar to turbulent regime is defined by the following equations:

$$p_{\text{cr}} = (p_{\text{avg}} + p_{\text{atm}})(1 - B_{\text{lam}})$$

$$p_{\text{avg}} = (p_A + p_B)/2$$

where

p_{avg}	Average pressure between the block terminals
p_{atm}	Atmospheric pressure, 101325 Pa
B_{lam}	Pressure ratio at the transition between laminar and turbulent regimes (Laminar flow pressure ratio parameter value)

- By Reynolds number — The transition from laminar to turbulent regime is defined by the following equations:

$$p_{cr} = \frac{\rho}{2} \left(\frac{Re_{cr} \cdot \nu}{C_D \cdot D_H} \right)^2$$

$$D_H = \sqrt{\frac{4A}{\pi}}$$

where

D_H	Instantaneous orifice hydraulic diameter
ν	Fluid kinematic viscosity
Re_{cr}	Critical Reynolds number (Critical Reynolds number parameter value)

In the third case, when an orifice is defined by its pressure-flow characteristics, the flow rate is determined by two-dimensional interpolation. In this case, neither flow regime nor leakage flow rate is taken into account, because these features are assumed to be introduced through the tabulated data. Pressure-flow characteristics are specified with three data sets: array of orifice openings, array of pressure differentials across the orifice, and matrix of flow rate values. Each value of a flow rate corresponds to a specific combination of an opening and pressure differential.

The block positive direction is from port A to port B. This means that the flow rate is positive if it flows from A to B and the pressure differential is determined as $\Delta p = p_A - p_B$. Positive signal at the physical signal port S opens or closes the orifice depending on the value of the orifice orientation indicator.

Basic Assumptions and Limitations

- Fluid inertia is not taken into account.
- For orifices specified by pressure-flow characteristics (the third parameterization option), the model does not explicitly account for the flow regime or leakage flow rate, because the tabulated data is assumed to account for these characteristics.

Parameters

Model parameterization

Select one of the following methods for specifying the orifice:

- By maximum area and opening — Provide values for the maximum orifice area and the maximum orifice opening. The passage area is linearly dependent on the control member displacement, that is, the orifice is closed at the initial position of the control member (zero displacement), and the maximum opening takes place at the maximum displacement. This is the default method.

- **By area vs. opening table** — Provide tabulated data of orifice openings and corresponding orifice areas. The passage area is determined by one-dimensional table lookup. You have a choice of two interpolation methods and two extrapolation methods.
- **By pressure-flow characteristic** — Provide tabulated data of orifice openings, pressure differentials, and corresponding flow rates. The flow rate is determined by two-dimensional table lookup. You have a choice of two interpolation methods and two extrapolation methods.

Orifice maximum area

Specify the area of a fully opened orifice. The parameter value must be greater than zero. The default value is $5e-5 \text{ m}^2$. This parameter is used if **Model parameterization** is set to **By maximum area and opening**.

Orifice maximum opening

Specify the maximum displacement of the control member. The parameter value must be greater than zero. The default value is $5e-4 \text{ m}$. This parameter is used if **Model parameterization** is set to **By maximum area and opening**.

Orifice opening vector, *s*

Specify the vector of input values for orifice openings as a one-dimensional array. The input values vector must be strictly increasing. The values can be nonuniformly spaced. The minimum number of values depends on the interpolation method: you must provide at least two values for linear interpolation, at least three values for smooth interpolation. The default values, in meters, are $[-0.002 \ 0 \ 0.002 \ 0.005 \ 0.015]$. If **Model parameterization** is set to **By area vs. opening table**, the **Tabulated orifice openings** values will be used together with **Tabulated orifice area** values for one-dimensional table lookup. If **Model parameterization** is set to **By pressure-flow characteristic**, the **Tabulated orifice openings** values will be used together with **Tabulated pressure differentials** and **Tabulated flow rates** for two-dimensional table lookup.

Orifice area vector

Specify the vector of orifice areas as a one-dimensional array. The vector must be of the same size as the orifice openings vector. All the values must be positive. The default values, in m^2 , are $[1e-09 \ 2.0352e-07 \ 4.0736e-05 \ 0.00011438 \ 0.00034356]$. This parameter is used if **Model parameterization** is set to **By area vs. opening table**.

Pressure differential vector, *dp*

Specify the pressure differential vector as a one-dimensional array. The vector must be strictly increasing. The values can be nonuniformly spaced. The minimum number of values depends on the interpolation method: you must provide at least two values for linear interpolation, at least three values for smooth interpolation. The default values, in Pa, are $[-1e+07 \ -5e+06 \ -2e+06 \ 2e+06 \ 5e+06 \ 1e+07]$. This parameter is used if **Model parameterization** is set to **By pressure-flow characteristic**.

Volumetric flow rate table, *q(s,dp)*

Specify the flow rates as an *m*-by-*n* matrix, where *m* is the number of orifice openings and *n* is the number of pressure differentials. Each value in the matrix specifies flow rate taking place at a specific combination of orifice opening and pressure differential. The matrix size must match the dimensions defined by the input vectors. The default values, in m^3/s , are:

```
[-1e-07 -7.0711e-08 -4.4721e-08 4.4721e-08 7.0711e-08 1e-07;
-2.0352e-05 -1.4391e-05 -9.1017e-06 9.1017e-06 1.4391e-05 2.0352e-05;
-0.0040736 -0.0028805 -0.0018218 0.0018218 0.0028805 0.0040736;
-0.011438 -0.0080879 -0.0051152 0.0051152 0.0080879 0.011438;
-0.034356 -0.024293 -0.015364 0.015364 0.024293 0.034356;]
```

This parameter is used if **Model parameterization** is set to `By pressure-flow characteristic`.

Interpolation method

Select one of the following interpolation methods for approximating the output value when the input value is between two consecutive grid points:

- **Linear** — Select this option to get the best performance.
- **Smooth** — Select this option to produce a continuous curve (`By area vs. opening table`) or surface (`By pressure-flow characteristic`) with continuous first-order derivatives.

For more information on interpolation algorithms, see the PS Lookup Table (1D) and PS Lookup Table (2D) block reference pages.

Extrapolation method

Select one of the following extrapolation methods for determining the output value when the input value is outside the range specified in the argument list:

- **Linear** — Select this option to produce a curve or surface with continuous first-order derivatives in the extrapolation region and at the boundary with the interpolation region.
- **Nearest** — Select this option to produce an extrapolation that does not go above the highest point in the data or below the lowest point in the data.

For more information on extrapolation algorithms, see the PS Lookup Table (1D) and PS Lookup Table (2D) block reference pages.

Orifice orientation

The parameter is introduced to specify the effect of the orifice control member motion on the valve opening. The parameter can be set to one of two options: `Opens in positive direction` or `Opens in negative direction`. The value `Opens in positive direction` specifies an orifice whose control member opens the valve when it is shifted in the globally assigned positive direction. The parameter is extremely useful for building a multi-orifice valve with all the orifices being controlled by the same spool. The default value is `Opens in positive direction`.

Flow discharge coefficient

Semi-empirical parameter for orifice capacity characterization. Its value depends on the geometrical properties of the orifice, and usually is provided in textbooks or manufacturer data sheets. The default value is `0.7`.

Initial opening

Orifice initial opening. The parameter can be positive (underlapped orifice), negative (overlapped orifice), or equal to zero for zero lap configuration. The value of initial opening does not depend on the orifice orientation. The default value is `0`.

Leakage area

The total area of possible leaks in the completely closed orifice. The main purpose of the parameter is to maintain numerical integrity of the circuit by preventing a portion of the system from getting isolated after the valve is completely closed. The parameter value must be greater than 0. The default value is `1e-12 m^2`.

Laminar transition specification

Select how the block transitions between the laminar and turbulent regimes:

- **Pressure ratio** — The transition from laminar to turbulent regime is smooth and depends on the value of the **Laminar flow pressure ratio** parameter. This method provides better simulation robustness.
- **Reynolds number** — The transition from laminar to turbulent regime is assumed to take place when the Reynolds number reaches the value specified by the **Critical Reynolds number** parameter.

Laminar flow pressure ratio

Pressure ratio at which the flow transitions between laminar and turbulent regimes. The default value is 0.999. This parameter is visible only if the **Laminar transition specification** parameter is set to **Pressure ratio**.

Critical Reynolds number

The maximum Reynolds number for laminar flow. The value of the parameter depends on the orifice geometrical profile. You can find recommendations on the parameter value in hydraulics textbooks. The default value is 12. This parameter is visible only if the **Laminar transition specification** parameter is set to **Reynolds number**.

Variables Tab

Volumetric flow rate

Flow rate specified as the fluid volume per unit time at time zero. The value entered serves as a guide during model compilation. The actual flow rate can differ if needed to satisfy all model constraints. Set the **Priority** level to **High** to prioritize the specified value during model assembly.

Pressure drop

Pressure change from port A to port B at time zero. The value entered serves as a guide during model compilation. The actual flow rate can differ if needed to satisfy all model constraints. Set the **Priority** level to **High** to prioritize the specified value during model assembly.

Restricted Parameters

When your model is in Restricted editing mode, you cannot modify the following parameters:

- **Model parameterization**
- **Orifice orientation**
- **Interpolation method**
- **Extrapolation method**
- **Laminar transition specification**

All other block parameters are available for modification. The actual set of modifiable block parameters depends on the value of the **Model parameterization** parameter at the time the model entered Restricted mode.

Global Parameters

Parameters determined by the type of working fluid:

- **Fluid density**
- **Fluid kinematic viscosity**

Use the Hydraulic Fluid block or the Custom Hydraulic Fluid block to specify the fluid properties.

Ports

The block has the following ports:

A

Hydraulic conserving port associated with the orifice inlet.

B

Hydraulic conserving port associated with the orifice outlet.

S

Physical signal port to control spool displacement.

The flow rate is positive if fluid flows from port A to port B. Positive signal at the physical signal port S opens or closes the orifice depending on the value of the parameter **Orifice orientation**.

Examples

The “Hydraulic Flapper-Nozzle Amplifier” example illustrates the use of the Variable Orifice block in hydraulic systems.

Extended Capabilities

C/C++ Code Generation

Generate C and C++ code using Simulink® Coder™.

See Also

Annular Orifice | Constant Area Hydraulic Orifice | Fixed Orifice | Orifice with Variable Area Round Holes | Orifice with Variable Area Slot | PS Lookup Table (1D) | PS Lookup Table (2D) | Variable Area Hydraulic Orifice

Topics

“Upgrading Simscape Fluids Models Containing Hydraulics (Isothermal) Blocks”

Introduced in R2006a

Variable Orifice Between Round Holes

Hydraulic variable orifice at intersection of two holes



Library

Orifices

Description

The Variable Orifice Between Round Holes block models a variable orifice created by two interacting round holes. These holes can have different diameters. One hole is located in the sleeve, while the other is drilled in the case, with the sleeve sliding along the case. Such a configuration is frequently seen in cartridge valves, as shown in this 3-way valve schematic.

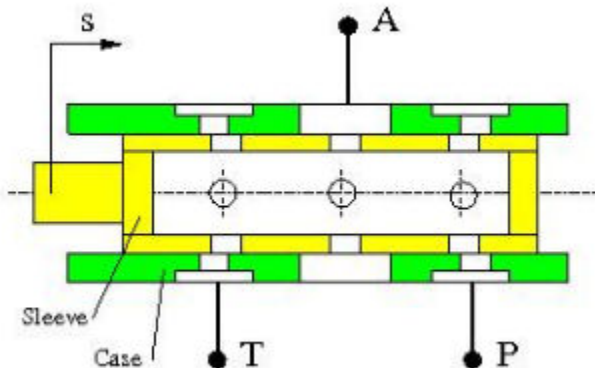

The block can contain multiple identical interacting pairs of holes. The following schematic shows the calculation diagram for one such pair of round holes, where

s	Sleeve displacement from initial position
c	Distance between hole centers
d_s	Sleeve hole diameter
d_c	Case hole diameter

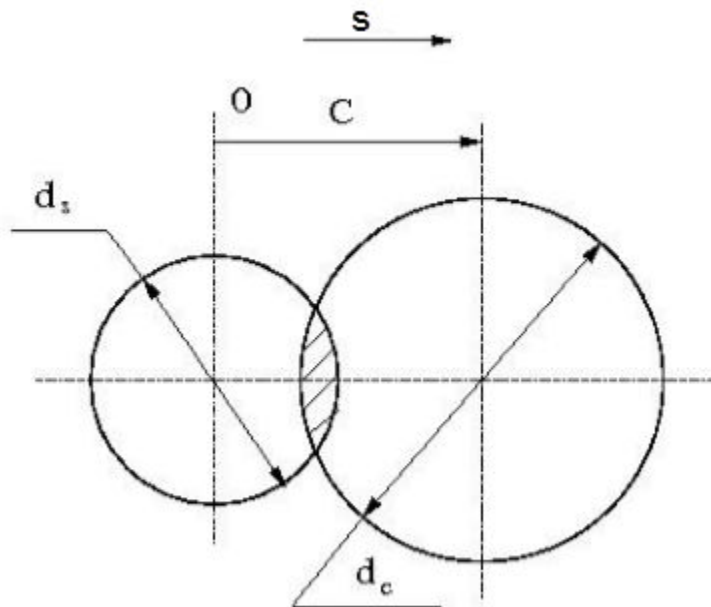

The flow rate through the orifice is proportional to the orifice area and to the pressure differential across the orifice, according to these equations:

$$A = \begin{cases} A_{leak} & \text{for } c \geq (r + R) \\ A_{leak} + r^2 \cdot a \cos\left(\frac{c^2 + r^2 - R^2}{2cr}\right) + R^2 \cdot a \cos\left(\frac{c^2 - r^2 + R^2}{2cr}\right) & \text{for } c < (r + R) \\ -\frac{1}{2}\sqrt{(-c + r + R)(c + R - r)(c + r - R)(c + r + R)} & \end{cases}$$

$$q = z \cdot C_D \cdot A \sqrt{\frac{2}{\rho}} \cdot \frac{p}{(p^2 + p_{cr}^2)^{1/4}}$$

$$\Delta p = p_A - p_B$$

where

q	Flow rate
p	Pressure differential
p_A, p_B	Gauge pressures at the block terminals
A	Instantaneous passage area between orifices
c	Instantaneous distance between hole centers
r	Smaller hole radius
R	Larger hole radius
z	Number of hole pairs
C_D	Flow discharge coefficient

ρ	Fluid density
A_{leak}	Closed orifice leakage area
p_{cr}	Minimum pressure for turbulent flow

The minimum pressure for turbulent flow, p_{cr} , is calculated according to the laminar transition specification method:

- By pressure ratio — The transition from laminar to turbulent regime is defined by the following equations:

$$p_{\text{cr}} = (p_{\text{avg}} + p_{\text{atm}})(1 - B_{\text{lam}})$$

$$p_{\text{avg}} = (p_A + p_B)/2$$

where

p_{avg}	Average pressure between the block terminals
p_{atm}	Atmospheric pressure, 101325 Pa
B_{lam}	Pressure ratio at the transition between laminar and turbulent regimes (Laminar flow pressure ratio parameter value)

- By Reynolds number — The transition from laminar to turbulent regime is defined by the following equations:

$$p_{\text{cr}} = \frac{\pi}{4A} \left(\frac{\text{Re}_{\text{cr}}}{C_D} \right)^2 \cdot \rho \cdot \frac{\nu^2}{2}$$

where

ν	Fluid kinematic viscosity
Re_{cr}	Critical Reynolds number (Critical Reynolds number parameter value)

The block positive direction is from port A to port B. This means that the flow rate is positive if it flows from A to B. Positive signal at port S moves the sleeve in the positive direction.

Basic Assumptions and Limitations

Inertial effects are not taken into account.

Parameters

Sleeve hole diameter

Diameter of the holes drilled in the sleeve. The default value is 0.005 m.

Case hole diameter

Diameter of the holes drilled in the case. The default value is 0.0054 m.

Number of interacting pairs

Number of interacting hole pairs. The default value is 1.

Flow discharge coefficient

Semi-empirical parameter for orifice capacity characterization. Its value depends on the geometrical properties of the orifice, and usually is provided in textbooks or manufacturer data sheets. The default value is 0.7.

Laminar transition specification

Select how the block transitions between the laminar and turbulent regimes:

- **Pressure ratio** — The transition from laminar to turbulent regime is smooth and depends on the value of the **Laminar flow pressure ratio** parameter. This method provides better simulation robustness.
- **Reynolds number** — The transition from laminar to turbulent regime is assumed to take place when the Reynolds number reaches the value specified by the **Critical Reynolds number** parameter.

Laminar flow pressure ratio

Pressure ratio at which the flow transitions between laminar and turbulent regimes. The default value is 0.999. This parameter is visible only if the **Laminar transition specification** parameter is set to **Pressure ratio**.

Critical Reynolds number

The maximum Reynolds number for laminar flow. The value of the parameter depends on the orifice geometrical profile. You can find recommendations on the parameter value in hydraulics textbooks. The default value is 12. This parameter is visible only if the **Laminar transition specification** parameter is set to **Reynolds number**.

Leakage area

The total area of possible leaks in the completely closed orifice. The main purpose of the parameter is to maintain numerical integrity of the circuit by preventing a portion of the system from getting isolated after the orifice is completely closed. The parameter value must be greater than 0. The default value is $1e-12 \text{ m}^2$.

Global Parameters

Parameters determined by the type of working fluid:

- **Fluid density**
- **Fluid kinematic viscosity**

Use the Hydraulic Fluid block or the Custom Hydraulic Fluid block to specify the fluid properties.

Ports

The block has the following ports:

A

Hydraulic conserving port associated with the orifice inlet.

B

Hydraulic conserving port associated with the orifice outlet.

S

Physical signal port that provides the instantaneous value of the distance between the hole centers.

Extended Capabilities

C/C++ Code Generation

Generate C and C++ code using Simulink® Coder™.

See Also

[Annular Orifice](#) | [Orifice with Variable Area Round Holes](#) | [Orifice with Variable Area Slot](#) | [Variable Area Hydraulic Orifice](#) | [Variable Orifice](#)

Topics

“Upgrading Simscape Fluids Models Containing Hydraulics (Isothermal) Blocks”

Introduced in R2014b

Variable Overlapping Orifice (IL)

Orifice created by open segments with variable overlap in an isothermal system

Library: Simscape / Fluids / Isothermal Liquid / Valves & Orifices / Orifices



Description

The Variable Overlapping Orifice (IL) block models flow through round holes with varying overlapping areas, such as a moving sleeve within a fixed case. The overlapping holes can have different diameters, but additional holes along the spool or sleeve have the same diameter.

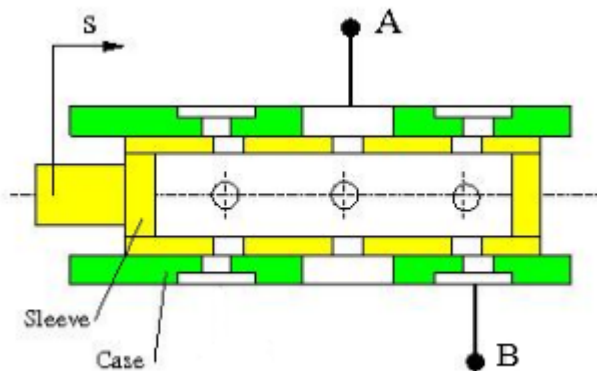

Overlapping Area

The flow rate depends on the variable open area created by overlapping holes in the sleeve and casing. This instantaneous opening area is calculated as:

$$A_{overlap} = r^2 \left[\cos^{-1} \left(\frac{C^2 + r^2 - R^2}{2Cr} \right) - \left(\frac{C^2 + r^2 - R^2}{2Cr} \right) \sqrt{1 - \left(\frac{C^2 + r^2 - R^2}{2Cr} \right)^2} \right] \\ + R^2 \left[\cos^{-1} \left(\frac{C^2 - r^2 + R^2}{2CR} \right) - \left(\frac{C^2 - r^2 + R^2}{2CR} \right) \sqrt{1 - \left(\frac{C^2 - r^2 + R^2}{2CR} \right)^2} \right],$$

where:

- r is the diameter of the smaller hole.
- R is the diameter of the larger hole.
- C is the absolute distance between the hole centers, calculated from the physical signal at port **S**, the instantaneous sleeve position, and the **Sleeve position when holes are concentric**, S_0 :
 $C = |S - S_0|$.

If the holes on the sleeve and casing have the same diameter, the overlap area becomes:

$$A_{overlap} = 2r^2 \left[\cos^{-1} \left(\frac{C}{2r} \right) - \left(\frac{C}{2r} \right) \sqrt{1 - \left(\frac{C}{2r} \right)^2} \right].$$

Numerically-Smoothed Displacement

You can maintain numerical robustness in your simulation by adjusting the block **Smoothing factor** at the nearest and farthest points between hole centers. A smoothing function is applied to every calculated distance, but primarily influences the simulation at the extremes of this range.

The normalized hole center distance is:

$$\widehat{C} = \frac{(C - R + r)}{(2r)},$$

The **Smoothing factor**, s , is applied to the normalized opening:

$$\widehat{C}_{smoothed} = \frac{1}{2} + \frac{1}{2} \sqrt{\widehat{C}^2 + \left(\frac{s}{4} \right)^2} - \frac{1}{2} \sqrt{(\widehat{C} - 1)^2 + \left(\frac{s}{4} \right)^2}.$$

The smoothed opening is:

$$C_{smoothed} = \widehat{C}_{smoothed}(2r) + (R - r).$$

Mass Flow Rate Equation

The flow through an orifice pair is calculated from the pressure-area relationship:

$$\dot{m} = \frac{C_d A_{orifice} \sqrt{2\bar{\rho}}}{\sqrt{PR_{loss} \left(1 - \left(\frac{A_{orifice}}{A_{port}} \right)^2 \right)}} \frac{\Delta p}{[\Delta p^2 + \Delta p_{crit}^2]^{1/4}},$$

where:

- C_d is the **Discharge coefficient**.
- $A_{orifice}$ is the area open to flow, $A_{orifice} = A_{overlap} + A_{leak}$.
- A is the **Cross-sectional area at ports A and B**.
- $\bar{\rho}$ is the average fluid density.

Pressure loss describes the reduction of pressure in the valve due to a decrease in area. The pressure loss term, PR_{loss} is calculated as:

$$PR_{loss} = \frac{\sqrt{1 - \left(\frac{A_{overlapping}}{A_{port}} \right)^2 (1 - C_d^2)} - C_d \frac{A_{overlapping}}{A_{port}}}{\sqrt{1 - \left(\frac{A_{overlapping}}{A_{port}} \right)^2 (1 - C_d^2)} + C_d \frac{A_{overlapping}}{A_{port}}}.$$

Pressure recovery describes the positive pressure change in the valve due to an increase in area. If you do not wish to capture this increase in pressure, set **Pressure recovery** to Off. In this case, PR_{loss} is 1.

The critical pressure difference, Δp_{crit} , is the pressure differential associated with the **Critical Reynolds number**, Re_{crit} , the flow regime transition point between laminar and turbulent flow:

$$\Delta p_{crit} = \frac{\pi \bar{\rho}}{8A_{overlapping}} \left(\frac{\nu Re_{crit}}{C_d} \right)^2.$$

Ports

Conserving

A – Liquid port

isothermal liquid

Entry or exit point to the orifice.

B – Liquid port

isothermal liquid

Entry or exit point to the orifice.

Input

S – Sleeve displacement, m

physical signal

Sleeve position with respect to the case, in m.

Parameters

Sleeve hole diameter – Sleeve hole diameter

5e-3 m (default) | positive scalar

Diameter of the hole in the moving element.

Case hole diameter – Case hole diameter

5.5e-3 m (default) | positive scalar

Diameter of hole in the fixed element.

Sleeve position when holes are concentric – Moving element position when hole centers are aligned

0 m (default) | scalar

Moving element position when hole centers are aligned. This parameter is used to determine instantaneous overlap of the moving and stationary holes during simulation by comparison with the signal received at port **S**.

Number of interacting pairs – Number of overlapping orifices, in pairs

1 (default) | positive scalar

Number of overlapping orifices, in pairs. The sleeve-case pairs do not need to be aligned in the physical hardware being modeled.

Leakage area — Gap area when in fully closed position`1e-10 m^2 (default) | positive scalar`

Sum of all gaps when the valve is in the fully closed position. Any area smaller than this value is maintained at the specified leakage area. This contributes to numerical stability by maintaining continuity in the flow.

Cross-sectional area at ports A and B — Orifice area at conserving ports`inf m^2 (default) | positive scalar`

Areas at the entry and exit ports **A** and **B**, which are used in the pressure-flow rate equation that determines the mass flow rate through the orifice.

Discharge coefficient — Discharge coefficient`0.64 (default) | positive scalar`

Correction factor that accounts for discharge losses in theoretical flows.

Critical Reynolds number — Upper Reynolds number limit for laminar flow`150 (default) | positive scalar`

Upper Reynolds number limit for laminar flow through the orifice.

Smoothing factor — Numerical smoothing factor`0.01 (default) | positive scalar in the range [0,1]`

Continuous smoothing factor that introduces a layer of gradual change to the flow response when the valve is in near-open or near-closed positions. Set this value to a nonzero value less than one to increase the stability of your simulation in these regimes.

Pressure recovery — Whether to account for pressure increase in area expansions`Off (default) | On`

Whether to account for pressure increase when fluid flows from a region of smaller cross-sectional area to a region of larger cross-sectional area.

See Also

Spool Orifice (IL) | Annular Leakage (IL) | Orifice (IL)

Introduced in R2020a

Variable-Displacement Motor

Variable-displacement bidirectional hydraulic motor

Library: Simscape / Fluids / Hydraulics (Isothermal) / Pumps and Motors



Description

The Variable-Displacement Motor block represents a device that extracts power from a hydraulic (isothermal liquid) network and delivers it to a mechanical rotational network. The motor displacement varies in proportion to the physical signal input specified at port C or D. The exact port used depends on the block variant selected. See “Ports” on page 1-1693.

Ports **A** and **B** represent the motor inlet and outlet, respectively. Port **S** represents the motor drive shaft. During normal operation, the angular velocity at port **S** is positive if the pressure drop from port **A** to port **B** is positive also. This operation mode is referred to here as forward motor.

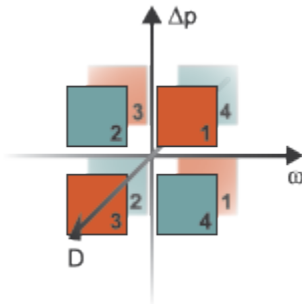

Operation Modes

A total of four operation modes are possible. The working mode depends on the pressure drop from port **A** to port **B** (Δp), on the angular velocity at port **S** (ω), and on the instantaneous volumetric displacement of the component (D). The “Operation Modes” on page 1-1686 figure maps the modes to the octants of a Δp - ω - D chart. The modes are labeled 1-4:

- **Mode 1:** forward motor — A positive pressure drop generates a positive shaft angular velocity.
- **Mode 2:** reverse pump — A negative shaft angular velocity generates a negative pressure gain (shown in the figure as a positive pressure drop).
- **Mode 3:** reverse motor — A negative pressure drop generates a negative shaft angular velocity.
- **Mode 4:** forward pump — A positive shaft angular velocity generates a positive pressure gain (shown in the figure as a negative pressure drop).

The response time of the motor is considered negligible in comparison with the system response time. The motor is assumed to reach steady state nearly instantaneously and is treated as a quasi-steady component.

Block Variants and Loss Parameterizations

The motor model accounts for power losses due to leakage and friction. Leakage is internal and occurs between the motor inlet and outlet only. The block computes the leakage flow rate and friction torque using your choice of five loss parameterizations. You select a parameterization using block variants and, in the `Analytical` or `tabulated data` case, the **Friction and leakage parameterization** parameter.

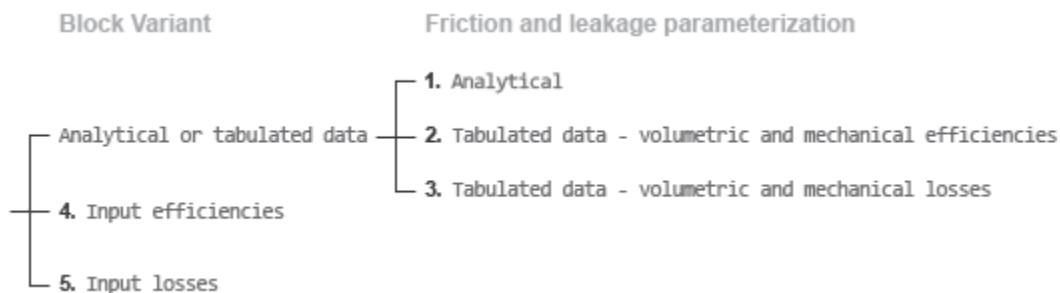

Loss Parameterizations

The block provides three Simulink variants to select from. To change the active block variant, right-click the block and select **Simscape > Block choices**. The available variants are:

- `Analytical or tabulated data` — Obtain the mechanical and volumetric efficiencies or losses from analytical models based on nominal parameters or from tabulated data. Use the **Friction and leakage parameterization** parameter to select the exact input type.
- `Input efficiencies` — Provide the mechanical and volumetric efficiencies directly through physical signal input ports.
- `Input losses` — Provide the mechanical and volumetric losses directly through physical signal input ports. The mechanical loss is defined as the internal friction torque. The volumetric loss is defined as the internal leakage flow rate.

Displacement Parameterizations

The displacement volume input depends on the block variant selected. If the active block variant is `Input efficiencies` or `Input losses`, the block obtains the instantaneous displacement volume directly from the physical signal input at port D.

If the active block variant is `Analytical or tabulated data`, the block computes the instantaneous displacement volume from the control member position specified at port C. This computation depends on the **Displacement parameterization** parameter setting:

- `Maximum displacement and control member stroke` — Compute the displacement volume per unit rotation as a linear function of the control member position specified at port C.
- `Displacement vs. control member position table` — Compute the displacement volume per unit volume using interpolation or extrapolation of displacement tabular data specified at discrete control member positions.

Flow Rate and Driving Torque

The volumetric flow rate generated at the motor is

$$q = q_{\text{Ideal}} + q_{\text{Leak}},$$

where:

- q is the net volumetric flow rate.
- q_{Ideal} is the ideal volumetric flow rate.
- q_{Leak} is the internal leakage volumetric flow rate.

The torque generated at the motor is

$$\tau = \tau_{\text{Ideal}} - \tau_{\text{Friction}},$$

where:

- τ is the net torque.
- τ_{Ideal} is the ideal torque.
- τ_{Friction} is the friction torque.

Ideal Flow Rate and Ideal Torque

The ideal volumetric flow rate is

$$q_{\text{Ideal}} = D_{\text{Sat}} \cdot \omega,$$

and the ideal generated torque is

$$\tau_{\text{Ideal}} = D_{\text{Sat}} \cdot \Delta p,$$

where:

- D_{Sat} is a smoothed displacement computed so as to remove numerical discontinuities between negative and positive displacements.
- ω is the instantaneous angular velocity of the rotary shaft.
- Δp is the instantaneous pressure drop from inlet to outlet.

Saturation Displacement

The saturation displacement depends on the block variant selected. If the active variant is Analytical or tabulated data,

$$D_{\text{Sat}} = \begin{cases} \text{sign}(D) \cdot D_{\text{Max}}, & |D| \geq D_{\text{Max}} \\ \sqrt{D^2 + D_{\text{Threshold}}^2}, & D \geq 0 \\ -\sqrt{D^2 + D_{\text{Threshold}}^2}, & D < 0 \end{cases},$$

where:

- D is the instantaneous fluid displacement determined from the physical signal input specified at port **C** or port **D**.

- D_{Max} is the specified value of the **Maximum displacement** block parameter.
- $D_{\text{Threshold}}$ is the specified value of the **Displacement threshold for motor-pump transition** block parameter.

If the active variant is **Input efficiencies** or **Input losses**, there is no upper bound on the displacement input and the saturation displacement reduces to:

$$D_{\text{Sat}} = \begin{cases} \sqrt{D^2 + D_{\text{Threshold}}^2}, & D \geq 0 \\ -\sqrt{D^2 + D_{\text{Threshold}}^2}, & D < 0 \end{cases}$$

Leakage Flow Rate and Friction Torque

The internal leakage flow rate and friction torque calculations depend on the block variant selected. If the block variant is **Analytical** or **tabulated data**, the calculations depend also on the **Leakage and friction parameterization** parameter setting. There are five possible permutations of block variant and parameterization settings.

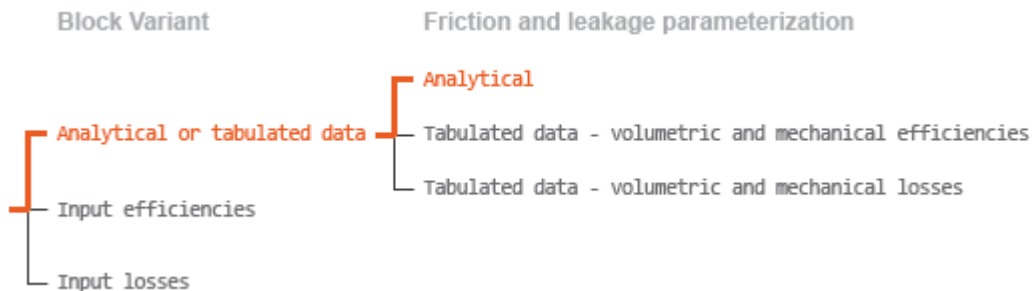

Case 1: Analytical Efficiency Calculation

If the active block variant is **Analytical** or **tabulated data** and the **Leakage and friction parameterization** parameter is set to **Analytical**, the leakage flow rate is

$$q_{\text{Leak}} = K_{\text{HP}} \Delta p,$$

and the friction torque is

$$\tau_{\text{Friction}} = \left(\tau_0 + K_{\text{TP}} \left| \frac{D_{\text{Sat}}}{D_{\text{Max}}} \right| |\Delta p| \right) \tanh \left(\frac{4\omega}{\omega_{\text{Thresh}}} \right),$$

where:

- K_{HP} is the Hagen-Poiseuille coefficient for laminar pipe flows. This coefficient is computed from the specified nominal parameters.
- K_{TP} is the specified value of the **Friction torque vs pressure drop coefficient** block parameter.
- τ_0 is the specified value of the **No-load torque** block parameter.
- $\omega_{\text{Threshold}}$ is the threshold angular velocity for the motor-pump transition. The threshold angular velocity is an internally set fraction of the specified value of the **Nominal shaft angular velocity** block parameter.

The Hagen-Poiseuille coefficient is determined from nominal fluid and component parameters through the equation

$$K_{HP} = \frac{\nu_{Nom} \rho_{Nom} \omega_{Nom} D_{Max}}{\rho \nu} \frac{\Delta p_{Nom}}{\Delta p_{Nom}} \left(\frac{1}{\eta_{v,Nom}} - 1 \right),$$

where:

- ν_{Nom} is the **Nominal kinematic viscosity** parameter. This is the kinematic viscosity at which the nominal volumetric efficiency is specified.
- ρ_{Nom} is the **Nominal fluid density** parameter. This is the density at which the nominal volumetric efficiency is specified.
- ρ is the actual fluid density in the attached hydraulic (isothermal liquid) network. This density can differ from the **Nominal fluid density** parameter.
- ω_{Nom} is the **Nominal shaft angular velocity** parameter. This is the angular velocity at which the nominal volumetric efficiency is specified.
- ν is the fluid kinematic viscosity in the attached hydraulic fluid network.
- Δp_{Nom} is the **Nominal pressure drop** parameter. This is the pressure drop at which the nominal volumetric efficiency is specified.
- $\eta_{v,Nom}$ is the **Volumetric efficiency at nominal conditions** parameter. This is the volumetric efficiency corresponding to the specified nominal conditions.

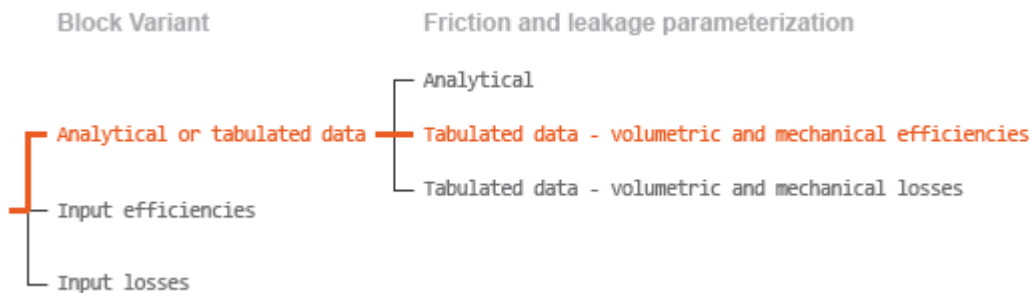

Case 2: Efficiency Tabulated Data

If the active block variant is **Analytical or tabulated data** and the **Leakage and friction parameterization** parameter is set to **Tabulated data – volumetric and mechanical efficiencies**, the leakage flow rate is

$$q_{Leak} = q_{Leak, Motor} \frac{(1 + \alpha)}{2} + q_{Leak, Pump} \frac{(1 - \alpha)}{2},$$

and the friction torque is

$$\tau_{Friction} = \tau_{Friction, Motor} \frac{1 + \alpha}{2} + \tau_{Friction, Pump} \frac{1 - \alpha}{2},$$

where:

- α is a numerical smoothing parameter for the motor-pump transition.
- $q_{Leak, Motor}$ is the leakage flow rate in motor mode.
- $q_{Leak, Pump}$ is the leakage flow rate in pump mode.
- $\tau_{Friction, Pump}$ is the friction torque in pump mode.

- $\tau_{\text{Friction, Motor}}$ is the friction torque in motor mode.

The smoothing parameter α is given by the hyperbolic function

$$\alpha = \tanh\left(\frac{4\Delta p}{\Delta p_{\text{Threshold}}}\right) \cdot \tanh\left(\frac{4\omega}{\omega_{\text{Threshold}}}\right) \cdot \tanh\left(\frac{4D}{D_{\text{Threshold}}}\right),$$

where:

- $\Delta p_{\text{Threshold}}$ is the specified value of the **Pressure drop threshold for motor-pump transition** block parameter.
- $\omega_{\text{Threshold}}$ is the specified value of the **Angular velocity threshold for motor-pump transition** block parameter.
- $D_{\text{Threshold}}$ is the specified value of the **Displacement threshold for motor-pump transition** block parameter.

The leakage flow rate is computed from efficiency tabulated data through the equation

$$q_{\text{Leak, Motor}} = (1 - \eta_v)q,$$

in motor mode and through the equation

$$q_{\text{Leak, Pump}} = -(1 - \eta_v)q_{\text{Ideal}}.$$

in pump mode, where:

- η_v is the volumetric efficiency obtained through interpolation or extrapolation of the **Volumetric efficiency table, e_v(dp,w,D)** parameter data.

Similarly, the friction torque is computed from efficiency tabulated data through the equation

$$\tau_{\text{Friction, Motor}} = (1 - \eta_m)\tau_{\text{Ideal}},$$

in motor mode and through the equation

$$\tau_{\text{Friction, Pump}} = -(1 - \eta_m)\tau.$$

in pump mode, where:

- η_m is the mechanical efficiency obtained through interpolation or extrapolation of the **Mechanical efficiency table, e_m(dp,w,D)** parameter data.

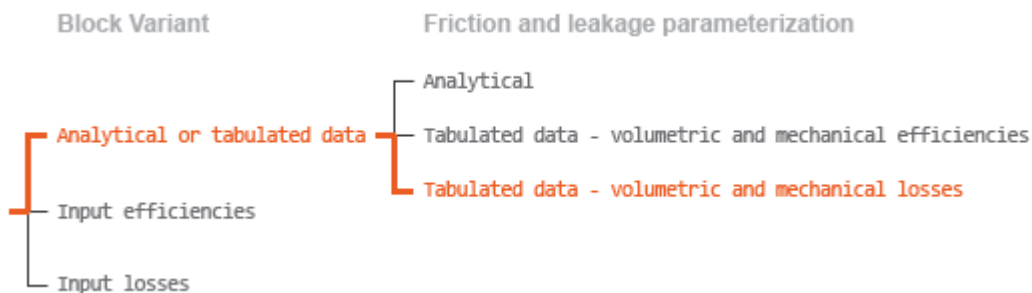

Case 3: Loss Tabulated Data

If the active block variant is Analytical or tabulated data and the **Leakage and friction parameterization** parameter is set to Tabulated data – volumetric and mechanical losses, the leakage flow rate equation is

$$q_{\text{Leak}} = q_{\text{Leak}}(\Delta p, \omega, D_{\text{Sat}}).$$

and the friction torque equation is

$$\tau_{\text{Friction}} = \tau_{\text{Friction}}(\Delta p, \omega, D_{\text{Sat}}),$$

where $q_{\text{Leak}}(\Delta p, \omega, D_{\text{Sat}})$ and $\tau_{\text{Friction}}(\Delta p, \omega, D_{\text{Sat}})$ are the volumetric and mechanical losses, obtained through interpolation or extrapolation of the **Volumetric loss table, $q_{\text{loss}}(\text{dp}, \text{w})$** and **Mechanical loss table, $\text{torque_loss}(\text{dp}, \text{w})$** parameter data.

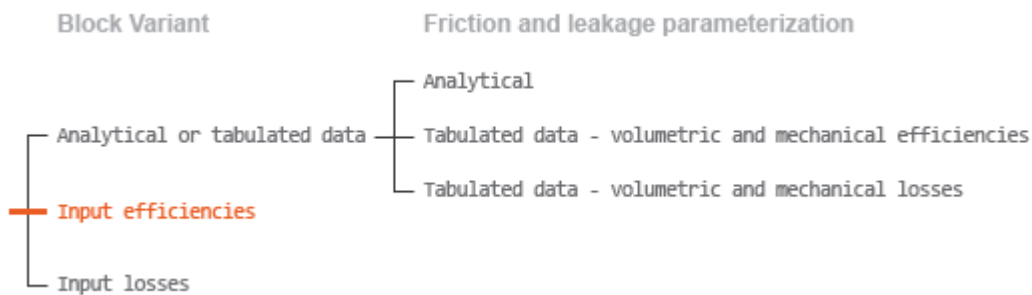

Case 4: Efficiency Physical Signal Inputs

If the active block variant is Input efficiencies, the leakage flow rate and friction torque calculations are as described for efficiency tabulated data (case 2). The volumetric and mechanical efficiency lookup tables are replaced with physical signal inputs that you specify through ports EV and EM.

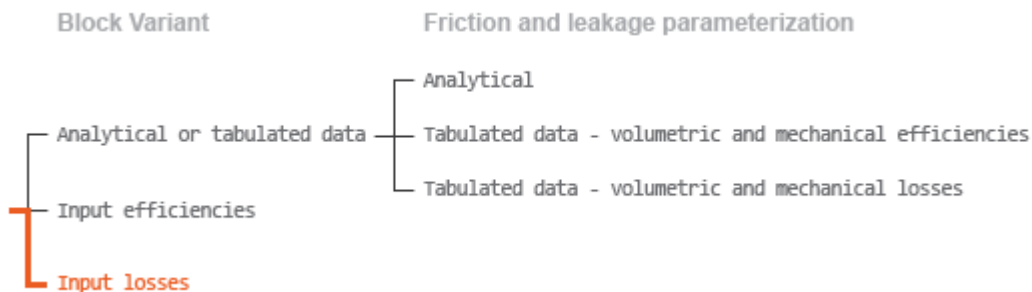

Case 5: Loss Physical Signal Inputs

If the block variant is Input losses, the leakage flow rate and friction torque calculations are as described for loss tabulated data (case 3). The volumetric and mechanical loss lookup tables are replaced with physical signal inputs that you specify through ports LV and LM.

Assumptions

- Fluid compressibility is negligible.
- Loading on the motor shaft due to inertia, friction, and spring forces is negligible.

Ports

Input

C — Control member position, m

physical signal

Physical signal input port for the control member position. The block maps the control member position to the corresponding displacement volume using the tabulated data specified in the block dialog box.

Dependencies

This port is exposed only when the block variant is set to `Analytical` or `tabulated data`.

D — Displacement volume, cm³/rev

physical signal

Physical signal input port for the volume of fluid displaced per unit rotation. A smoothing function eases the transition between positive and negative input values.

Dependencies

This port is exposed only when the block variant is set to `Input efficiencies` or `Input losses`.

EV — Volumetric efficiency, unitless

physical signal

Physical signal input port for the volumetric efficiency coefficient. The input signal has an upper bound at the **Maximum volumetric efficiency** parameter value and a lower bound at the **Minimum volumetric efficiency** parameter value.

Dependencies

This port is exposed only when the block variant is set to `Input efficiencies`.

EM — Mechanical efficiency, unitless

physical signal

Physical signal input port for the mechanical efficiency coefficient. The input signal has an upper bound at the **Maximum mechanical efficiency** parameter value and a lower bound at the **Minimum mechanical efficiency** parameter value.

Dependencies

This port is exposed only when the block variant is set to `Input efficiencies`.

LV — Volumetric loss, m³/s

physical signal

Physical signal input port for the volumetric loss, defined as the internal leakage flow rate between the motor inlets.

Dependencies

This port is exposed only when the block variant is set to `Input losses`.

LM — Mechanical loss, N*m

physical signal

Physical signal input port for the mechanical loss, defined as the friction torque on the rotating motor shaft.

Dependencies

This port is exposed only when the block variant is set to `Input losses`.

Conserving**A — Motor inlet**

hydraulic (isothermal liquid)

Hydraulic (isothermal liquid) conserving port representing the motor inlet.

B — Motor outlet

hydraulic (isothermal liquid)

Hydraulic (isothermal liquid) conserving port representing the motor outlet.

S — Motor shaft

mechanical rotational

Mechanical rotational conserving port representing the motor shaft.

Parameters

The exposed block parameters depend on the active block variant. See “Block Variants and Loss Parameterizations” on page 1-1687.

Variant 1: Analytical or tabulated data**Displacement parameterization — Parameterization used to map control positions to displacements**

Maximum displacement and control member stroke (default)

Parameterization used to convert the physical signal at input port C to an instantaneous displacement:

- `Maximum displacement and control member stroke` — Compute the displacement as a linear function of the control position specified at port C.
- `Displacement vs. control member position table` — Obtain the displacement through interpolation or extrapolation of tabulated data specified over a range of control positions.

Dependencies

This parameter is enabled when the block variant is set to `Analytical or tabulated data`.

Restricted Parameter

This parameter is locked for editing when using the Simscape Restricted mode.

Maximum stroke — Control position corresponding to maximum displacement

0.005 m (default) | scalar with units of length

Control position corresponding to a maximum displacement. The physical signal input at port C saturates at this value. If the input rises higher, the block sets the control position to the maximum stroke.

Dependencies

This parameter is enabled when the block variant is set to Analytical or tabulated data and the **Displacement parameterization** parameter is set to Maximum displacement and control member stroke.

Maximum displacement — Maximum fluid volume swept per unit shaft rotation

30 cm³/rev (default) | scalar with units of volume/angle

Maximum fluid volume swept per unit shaft rotation. The displacement reaches this value when the control position hits the maximum stroke.

Dependencies

This parameter is enabled when the block variant is set to Analytical or tabulated data and the **Displacement parameterization** parameter is set to Maximum displacement and control member stroke.

Control member position vector — Control positions at which to specify displacement tabular data

[-0.0075, -0.0025, 0.0, 0.0025, 0.0075] m (default) | *M*-element vector with units of length

M-element vector of control positions at which to specify the instantaneous displacement. The vector size, *M*, must be two or greater. The vector elements need not be uniformly spaced. However, they must be monotonically increasing or decreasing.

Dependencies

This parameter is enabled when the block variant is set to Analytical or tabulated data and the **Displacement parameterization** parameter is set to Displacement vs. control member position table.

Displacement vector — Displacement tabular data for the specified control positions

[-30.0, -19.0, 0.0, 19.0, 30.0] cm³/rev (default) | *M*-element vector with units of volume/angle

M-element vector with the displacement tabular data for the specified control positions. The vector size, *M*, must match that of the **Control member position vector** parameter.

Dependencies

This parameter is enabled when the block variant is set to Analytical or tabulated data and the **Displacement parameterization** parameter is set to Displacement vs. control member position table.

Interpolation method — Numerical technique used to determine displacements within the tabular data range

Linear (default) | Smooth

Numerical technique used to map control position signals to displacements within the tabular data range. The interpolation method joins tabular data points using straight or curved line segments. Displacements within the range of the tabular data are assumed to lie on these segments.

- **Linear** — Join neighboring data points using straight line segments. Line slopes are generally discontinuous at the line segment end points.
- **Smooth** — Join neighboring data points using curved line segments generated with a modified Akima algorithm. Line slopes are continuous at the line segment end points.

Dependencies

This parameter is enabled when the block variant is set to `Analytical` or `tabulated data` and the **Displacement parameterization** parameter is set to `Displacement vs. control member position table`.

Restricted Parameter

This parameter is locked for editing when using the Simscape Restricted mode.

Extrapolation method — Numerical technique used to determine displacements outside the tabular data range

`Linear` (default) | `Nearest`

Numerical technique used to map control position signals to displacements outside the tabular data range. The extrapolation method extends the first and last tabular data points outward using horizontal or sloped straight line segments. Displacements outside the range of the tabular data are assumed to lie on these segments.

- **Linear** — Extend the tabular data using sloped straight line segments. The line slopes are computed from the first and last two tabular data points.
- **Nearest** — Extend the tabular data using horizontal straight line segments. The lines correspond to the displacements specified in the first and last tabular data points.

Dependencies

This parameter is enabled when the block variant is set to `Analytical` or `tabulated data` and the **Displacement parameterization** parameter is set to `Displacement vs. control member position table`.

Restricted Parameter

This parameter is locked for editing when using the Simscape Restricted mode.

Leakage and friction parameterization — Parameterization used to compute leakage flow rate and friction torque

`Analytical` (default)

Parameterization used to compute flow-rate and torque losses due to internal leaks and friction. The `Analytical` parameterization relies on nominal parameters generally available from component data sheets. The remaining, tabular, options rely on lookup tables to map pressure drop, angular velocity, and displacement to component efficiencies or losses. The tabular options include:

- `Tabulated data – volumetric and mechanical efficiencies`
- `Tabulated data – volumetric and mechanical losses`

Dependencies

This parameter is enabled when the block variant is set to `Analytical` or `tabulated data`.

Nominal shaft angular velocity — Shaft angular velocity at which to specify the volumetric efficiency

188 rad/s (default) | scalar with units of angle/time

Angular velocity of the rotating shaft at which the component's nominal volumetric efficiency is known. Nominal parameters are typically published for standard operating conditions in manufacturer's data sheets. The block uses this parameter to calculate, using simple linear functions, the leakage flow rate and friction torque.

Dependencies

This parameter is enabled when the block variant is set to **Analytical** or **tabulated data** and the **Leakage and friction parameterization** parameter is set to **Analytical**.

Nominal pressure drop — Pressure drop at which to specify the volumetric efficiency

100e5 Pa (default) | scalar with units of pressure

Pressure drop from inlet to outlet at which the component's nominal volumetric efficiency is known. Nominal parameters are typically published for standard operating conditions in manufacturer's data sheets. The block uses this parameter to calculate, using a simple linear function, the internal leakage flow rate.

Dependencies

This parameter is enabled when the block variant is set to **Analytical** or **tabulated data** and the **Leakage and friction parameterization** parameter is set to **Analytical**.

Nominal kinematic viscosity — Kinematic viscosity at which to specify the volumetric efficiency

18 cSt (default) | scalar with units of area/time

Kinematic viscosity of the hydraulic fluid at which the component's nominal volumetric efficiency is known. Nominal parameters are typically published for standard operating conditions in manufacturer's data sheets. The block uses this parameter to calculate, using a simple linear function, the internal leakage flow rate.

Dependencies

This parameter is enabled when the block variant is set to **Analytical** or **tabulated data** and the **Leakage and friction parameterization** parameter is set to **Analytical**.

Nominal fluid density — Fluid density at which to specify the volumetric efficiency900 kg/m³ (default) | scalar with units of mass/volume

Mass density of the hydraulic fluid at which the component's nominal volumetric efficiency is known. Nominal parameters are typically published for standard operating conditions in manufacturer's data sheets. The block uses this parameter to calculate, using a simple linear function, the internal leakage flow rate.

Dependencies

This parameter is enabled when the block variant is set to **Analytical** or **tabulated data** and the **Leakage and friction parameterization** parameter is set to **Analytical**.

Volumetric efficiency at nominal conditions — Volumetric efficiency at the specified nominal conditions

0.92 (default) | unitless scalar between 0 and 1

Volumetric efficiency, defined as the ratio of actual to ideal volumetric flow rates, at the specified nominal conditions. Nominal parameters are typically published for standard operating conditions in manufacturer's data sheets. The block uses this parameter to calculate, using a simple linear function, the internal leakage flow rate.

Dependencies

This parameter is enabled when the block variant is set to `Analytical` or `tabulated data` and the **Leakage and friction parameterization** parameter is set to `Analytical`.

No-load torque – Minimum torque required to induce shaft rotation

0.05 N*m (default) | scalar with units of torque

Torque required to overcome seal friction and induce rotation of the mechanical shaft. This torque is the load-independent component of the total friction torque.

Dependencies

This parameter is enabled when the block variant is set to `Analytical` or `tabulated data` and the **Leakage and friction parameterization** parameter is set to `Analytical`.

Friction torque vs. pressure drop coefficient at maximum displacement – Proportionality constant at maximum displacement between friction torque and pressure drop

0.6e-6 N*m/Pa (default) | scalar with units of torque/pressure

Proportionality constant at maximum displacement between the friction torque on the mechanical shaft and the pressure drop from inlet to outlet.

Dependencies

This parameter is enabled when the block variant is set to `Analytical` or `tabulated data` and the **Leakage and friction parameterization** parameter is set to `Tabulated data – volumetric and mechanical efficiencies`.

Displacement threshold for motor-pump transition – Displacement below which the transition between motoring and pumping modes begins

0.5 cm³/rev (default) | scalar with units of volume/angle

Absolute value of the instantaneous displacement below which the component transitions between motoring and pumping modes. A hyperbolic Tanh function transforms the leakage flow rate and friction torque such that the transition is continuous and smooth.

Check if lower side pressure violating minimum valid condition – Simulation warning mode for minimum valid pressure

None (default) | `Warning`

Simulation warning mode for invalid pressures at the component ports. Select `Warning` to be notified when pressure falls below a minimum specified value. The warning can be useful in models where pressure can fall below the saturated vapor pressure of the hydraulic fluid, causing cavitation to occur.

Minimum valid pressure – Pressure required to trigger simulation warning

0 (default) | scalar with units of pressure

Lower bound of the pressure validity range. A warning is issued if pressure falls below the specified value.

Dependencies

This parameter is enabled when the **Check if lower side pressure violating minimum valid condition** parameter is set to Warning.

Pressure drop vector for efficiencies, **dp** – Pressure drops at which to specify the volumetric and mechanical efficiencies

M-element vector with units of pressure (default)

M-element vector of pressure drops at which to specify the efficiency tabular data. The vector size, *M*, must be two or greater. The vector elements need not be uniformly spaced. However, they must monotonically increase in value from left to right.

Dependencies

This parameter is enabled when the block variant is set to Analytical or tabulated data and the **Leakage and friction parameterization** parameter is set to Tabulated data – volumetric and mechanical efficiencies.

Shaft angular velocity vector for efficiencies, **w** – Angular velocities at which to specify the volumetric and mechanical efficiencies

N-element vector with units of angular velocity (default)

N-element vector of shaft angular velocities at which to specify the efficiency tabular data. The vector size, *N*, must be two or greater. The vector elements need not be uniformly spaced. However, they must monotonically increase in value from left to right.

Dependencies

This parameter is enabled when the block variant is set to Analytical or tabulated data and the **Leakage and friction parameterization** parameter is set to Tabulated data – volumetric and mechanical efficiencies.

Displacement vector for efficiencies, **D** – Displacements at which to specify the volumetric and mechanical efficiencies

L-element vector with units of volume/angle (default)

L-element vector of displacements at which to specify the efficiency tabular data. The vector size, *N*, must be two or greater. The vector elements need not be uniformly spaced. However, they must be monotonically increasing or decreasing.

Volumetric efficiency table, **e_v(dp,w,D)** – Volumetric efficiencies at the specified pressure drops, angular velocities, and displacements

unitless *M*-by-*N*-by-*L* matrix

M-by-*N*-by-*L* matrix with the volumetric efficiencies at the specified fluid pressure drops, shaft angular velocities, and displacements. The efficiencies must fall in the range of 0-1. *M*, *N*, and *L* are the sizes of the specified lookup-table vectors:

- *M* is the number of vector elements in the **Pressure drop vector for efficiencies, dp** parameter.
- *N* is the number of vector elements in the **Shaft angular velocity vector for efficiencies, w** parameter.

- L is the number of vector elements in the **Displacement vector for efficiencies, D** parameter.

Dependencies

This parameter is enabled when the block variant is set to `Analytical` or `tabulated data` and the **Leakage and friction parameterization** parameter is set to `Tabulated data – volumetric and mechanical efficiencies`.

Mechanical efficiency table, $e_m(dp,w,D)$ – Mechanical efficiencies at the specified pressure drops, angular velocities, and displacements

unitless M -by- N matrix

M -by- N -by- L matrix with the mechanical efficiencies corresponding to the specified fluid pressure drops, shaft angular velocities, and displacements. The efficiencies must fall in the range of 0-1. M , N , and L are the sizes of the specified lookup-table vectors:

- M is the number of vector elements in the **Pressure drop vector for efficiencies, dp** parameter.
- N is the number of vector elements in the **Shaft angular velocity vector for efficiencies, w** parameter.
- L is the number of vector elements in the **Displacement vector for efficiencies, D** parameter.

Dependencies

This parameter is enabled when the block variant is set to `Analytical` or `tabulated data` and the **Leakage and friction parameterization** parameter is set to `Tabulated data – volumetric and mechanical efficiencies`.

Pressure drop threshold for motor-pump transition – Pressure drop at which to initiate a smooth transition between motor and pump modes

$1e5$ Pa (default) | scalar with units of pressure

Pressure drop from inlet to outlet below which the component begins to transition between motoring and pumping modes. A hyperbolic `Tanh` function transforms the leakage flow rate and friction torque such that the transition is continuous and smooth.

Dependencies

This parameter is enabled when the block variant is set to `Input efficiencies` or when the block variant is set to `Analytical` or `tabulated data` and the **Leakage and friction parameterization** parameter is set to `Tabulated data – volumetric and mechanical efficiencies`.

Angular velocity threshold for motor-pump transition – Shaft angular velocity at which to initiate a smooth transition between pump and motor modes

10 rad/s (default) | scalar with units of angle/time

Shaft angular velocity below which the component begins to transition between motoring and pumping modes. A hyperbolic `Tanh` function transforms the leakage flow rate and friction torque such that the transition is continuous and smooth.

Dependencies

This parameter is enabled when the block variant is set to `Input efficiencies` or when the block variant is set to `Analytical` or `tabulated data` and the **Leakage and friction parameterization** parameter is set to `Tabulated data – volumetric and mechanical efficiencies`.

Check if operating beyond the octants of supplied tabulated data – Simulation warning mode for operating conditions outside the range of tabulated data

None (default) | Warning

Simulation warning mode for operating conditions outside the range of tabulated data. Select Warning to be notified when the fluid pressure drop, shaft angular velocity, or instantaneous displacement cross outside the specified tabular data. The warning does not cause simulation to stop.

Dependencies

This parameter is enabled when the block variant is set to Analytical or tabulated data and the **Leakage and friction parameterization** parameter is set to Tabulated data – volumetric and mechanical efficiencies or Tabulated data – volumetric and mechanical losses.

Pressure drop vector for losses, dp – Pressure drops at which to specify the volumetric and mechanical losses M -element vector with units of pressure (default)

M -element vector of pressure drops at which to specify the loss tabular data. The vector size, M , must be two or greater. The vector elements need not be uniformly spaced. However, they must monotonically increase in value from left to right.

Dependencies

This parameter is enabled when the block variant is set to Analytical or tabulated data and the **Leakage and friction parameterization** parameter is set to Tabulated data – volumetric and mechanical losses.

Shaft angular velocity vector for losses, w – Angular velocities at which to specify the volumetric and mechanical losses N -element vector with units of angle/time (default)

N -element vector of shaft angular velocities at which to specify the loss tabular data. The vector size, N , must be two or greater. The vector elements need not be uniformly spaced. However, they must monotonically increase in value from left to right.

Dependencies

This parameter is enabled when the block variant is set to Analytical or tabulated data and the **Leakage and friction parameterization** parameter is set to Tabulated data – volumetric and mechanical losses.

Displacement vector for losses, D – Displacements at which to specify the volumetric and mechanical losses L -element vector with units of volume/angle (default)

L -element vector of displacements at which to specify the loss tabular data. The vector size, N , must be two or greater. The vector elements need not be uniformly spaced. However, they must be monotonically increasing or decreasing.

Volumetric loss table, $q_loss(dp,w,D)$ – Internal leakage flow rates at the specified pressure drops, angular velocities, and displacements M -by- N -by- L matrix with units of volume/time

M -by- N -by- L matrix with the volumetric losses at the specified fluid pressure drops, shaft angular velocities, and displacements. Volumetric loss is defined here as the internal leakage volumetric flow rate between port A and port B. M , N , and L are the sizes of the specified lookup-table vectors:

- M is the number of vector elements in the **Pressure drop vector for losses, dp** parameter.
- N is the number of vector elements in the **Shaft angular velocity vector for losses, w** parameter.
- L is the number of vector elements in the **Displacement vector for losses, D** parameter.

Dependencies

This parameter is enabled when the block variant is set to Analytical or tabulated data and the **Leakage and friction parameterization** parameter is set to Tabulated data – volumetric and mechanical losses.

Mechanical loss table, torque_loss(dp,w,D) – Friction torques at the specified pressure drops, angular velocities, and displacements

M -by- N -by- L matrix with units of torque

M -by- N -by- L matrix with the mechanical losses at the specified fluid pressure drops, shaft angular velocities, and displacements. Mechanical loss is defined here as the friction torque due to seals and internal components. M , N , and L are the sizes of the specified lookup-table vectors:

- M is the number of vector elements in the **Pressure drop vector for losses, dp** parameter.
- N is the number of vector elements in the **Shaft angular velocity vector for losses, w** parameter.
- L is the number of vector elements in the **Displacement vector for losses, D** parameter.

Dependencies

This parameter is enabled when the block variant is set to Analytical or tabulated data and the **Leakage and friction parameterization** parameter is set to Tabulated data – volumetric and mechanical losses.

Variant 2: Input efficiencies

Pressure drop threshold for motor-pump transition – Pressure drop at which to initiate a smooth transition between motor and pump modes

1e5 Pa (default) | scalar with units of pressure

Pressure drop from inlet to outlet below which the component begins to transition between motoring and pumping modes. A hyperbolic Tanh function transforms the leakage flow rate and friction torque such that the transition is continuous and smooth.

Dependencies

This parameter is enabled when the block variant is set to Input efficiencies.

Angular velocity threshold for motor-pump transition – Angular velocity at which to initiate a smooth transition between pump and motor modes

10 rad/s (default) | scalar with units of angle/time

Shaft angular velocity below which the component begins to transition between motoring and pumping modes. A hyperbolic Tanh function transforms the leakage flow rate and friction torque such that the transition is continuous and smooth.

Dependencies

This parameter is enabled when the block variant is set to Input efficiencies.

Displacement threshold for motor-pump transition — Displacement at which to initiate a smooth transition between pump and motor modes

0.5 cm³/rev (default) | scalar with units of volume/angle

Absolute value of the instantaneous displacement below which the component transitions between motoring and pumping modes. A hyperbolic Tanh function transforms the leakage flow rate and friction torque such that the transition is continuous and smooth.

Minimum volumetric efficiency — Lower saturation bound on the volumetric efficiency input signal

1e-3 (default) | unitless scalar between 0 and 1

Smallest allowed value of the volumetric efficiency. The input from physical signal port EV saturates at the specified value. If the input signal falls below the minimum volumetric efficiency, the volumetric efficiency is set to the minimum volumetric efficiency.

Dependencies

This parameter is enabled when the block variant is set to Input efficiencies.

Maximum volumetric efficiency — Upper saturation bound on the volumetric efficiency input signal

1 (default) | unitless scalar between 0 and 1

Largest allowed value of the volumetric efficiency. The input from physical signal port EV saturates at the specified value. If the input signal rises above the maximum volumetric efficiency, the volumetric efficiency is set to the maximum volumetric efficiency.

Dependencies

This parameter is enabled when the block variant is set to Input efficiencies.

Minimum mechanical efficiency — Lower saturation bound on the volumetric efficiency input signal

1e-3 (default) | unitless scalar between 0 and 1

Smallest allowed value of the mechanical efficiency. The input from physical signal port EM saturates at the specified value. If the input signal falls below the minimum mechanical efficiency, the mechanical efficiency is set to the minimum mechanical efficiency.

Dependencies

This parameter is enabled when the block variant is set to Input efficiencies.

Maximum mechanical efficiency — Upper saturation bound on the volumetric efficiency input signal

1 (default) | unitless scalar between 0 and 1

Largest allowed value of the mechanical efficiency. The input from physical signal port EM saturates at this value. If the input signal rises above the maximum mechanical efficiency, the mechanical efficiency is set to the maximum mechanical efficiency.

Dependencies

This parameter is enabled when the block variant is set to `Input efficiencies`.

Check if lower side pressure violating minimum valid condition — Simulation warning mode for minimum valid pressure

None (default) | Warning

Simulation warning mode for invalid pressures at the component ports. Select `Warning` to be notified when pressure falls below a minimum specified value. The warning can be useful in models where pressure can fall below the saturated vapor pressure of the hydraulic fluid, causing cavitation to occur.

Minimum valid pressure — Pressure required to trigger simulation warning

0 (default) | scalar with units of pressure

Lower bound of the pressure validity range. A warning is issued if pressure falls below the specified value.

Dependencies

This parameter is enabled when the **Check if lower side pressure violating minimum valid condition** parameter is set to `Warning`.

Variant 3: Input losses**Displacement threshold for motor-pump transition — Displacement below which the transition between motoring and pumping modes begins**

0.5 cm³/rev (default) | scalar with units of volume/angle

Absolute value of the instantaneous displacement below which the component transitions between motoring and pumping modes. A hyperbolic Tanh function transforms the leakage flow rate and friction torque such that the transition is continuous and smooth.

Check if operating beyond the motor mode — Simulation warning mode for operating conditions outside motoring mode

None (default) | Warning

Simulation warning mode for operating conditions outside the motoring mode. A warning is issued if the motor transitions to pumping mode. Select `Warning` to be notified when this transition occurs. The warning does not cause simulation to stop.

Dependencies

This parameter is enabled when the block variant is set to `Input losses`.

Check if lower side pressure violating minimum valid condition — Simulation warning mode for minimum valid pressure

None (default) | Warning

Simulation warning mode for invalid pressures at the component ports. Select `Warning` to be notified when pressure falls below a minimum specified value. The warning can be useful in models where pressure can fall below the saturated vapor pressure of the hydraulic fluid, causing cavitation to occur.

Minimum valid pressure — Pressure required to trigger simulation warning

0 (default) | scalar with units of pressure

Lower bound of the pressure validity range. A warning is issued if pressure falls below the specified value.

Dependencies

This parameter is enabled when the **Check if lower side pressure violating minimum valid condition** parameter is set to Warning.

Extended Capabilities**C/C++ Code Generation**

Generate C and C++ code using Simulink® Coder™.

See Also

Fixed-Displacement Motor | Fixed-Displacement Motor (TL) | Fixed-Displacement Pump | Fixed-Displacement Pump (TL) | Variable-Displacement Pump

Topics

“Upgrading Simscape Fluids Models Containing Hydraulics (Isothermal) Blocks”

Variable-Displacement Motor (IL)

Variable-displacement motor in an isothermal liquid system

Library: Simscape / Fluids / Isothermal Liquid / Pumps & Motors

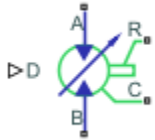

Description

The Variable-Displacement Motor (IL) block models a motor with variable-volume displacement. The fluid may move from port **A** to port **B**, called *forward mode*, or from port **B** to port **A**, called *reverse mode*. Motor mode operation occurs when there is a pressure drop in the direction of the flow. Pump mode operation occurs when there is a pressure gain in the direction of the flow.

The shaft rotation corresponds to the sign of the fluid volume moving through the motor, which is received as a physical signal at port **D**. Positive fluid displacement at **D** corresponds to positive shaft rotation in forward mode. Negative fluid displacement at **D** corresponds to negative shaft angular velocity in forward mode.

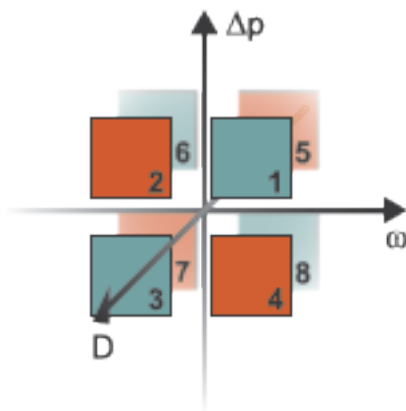

Operation Modes

The block has eight modes of operation. The working mode depends on the pressure drop from port **A** to port **B**, $\Delta p = p_A - p_B$; the angular velocity, $\omega = \omega_R - \omega_C$; and the fluid volumetric displacement at port **D**. The figure above maps these modes to the octants of a Δp - ω - D chart:

- Mode 1, *Forward Motor*: Flow from port **A** to port **B** causes a pressure decrease from **A** to **B** and a positive shaft angular velocity.
- Mode 2, *Reverse Pump*: Negative shaft angular velocity causes a pressure increase from port **B** to port **A** and flow from **B** to port **A**.

- Mode 3, *Reverse Motor*: Flow from port **B** to port **A** causes a pressure decrease from **B** to **A** and a negative shaft angular velocity.
- Mode 4, *Forward Pump*: Positive shaft angular velocity causes a pressure increase from port **A** to port **B** and flow from **A** to **B**.
- Mode 5, *Reverse Pump*: Positive shaft angular velocity causes a pressure increase from port **B** to port **A** and flow from **B** to **A**.
- Mode 6, *Forward Motor*: Flow from port **A** to port **B** causes a pressure decrease from **A** to **B** and a positive shaft angular velocity.
- Mode 7, *Forward Pump*: Negative shaft angular velocity causes a pressure increase from port **A** to port **B** and flow from **A** to **B**.
- Mode 8, *Reverse Motor*: Flow from **B** to **A** causes a pressure decrease from **B** to **A** and positive shaft angular velocity.

The motor block has analytical, lookup table, and physical signal parameterizations. When using tabulated data or an input signal for parameterization, you can choose to characterize the motor operation based on efficiency or losses.

The threshold parameters **Pressure drop threshold for motor-pump transition**, **Angular velocity threshold for motor-pump transition**, and **Displacement threshold for motor-pump transition** identify regions where numerically smoothed flow transition between the motor operational modes can occur. For the pressure and angular velocity thresholds, choose a transition region that provides some margin for the transition term, but which is small enough relative to the typical motor pressure drop and angular velocity so that it will not impact calculation results. For the displacement threshold, choose a threshold value that is smaller than the typical displacement volume during normal operation.

Analytical Leakage and Friction Parameterization

If you set **Leakage and friction parameterization** to `Analytical`, the block calculates internal leakage and shaft friction from constant nominal values of shaft velocity, pressure drop, volumetric displacement, and torque. The leakage flow rate, which is correlated with the pressure differential over the motor, is calculated as:

$$\dot{m}_{leak} = K\rho_{avg}\Delta p,$$

where:

- Δp_{nom} is $p_A - p_B$.
- ρ_{avg} is the average fluid density.
- K is the Hagen-Poiseuille coefficient for analytical loss,

$$K = \frac{D_{nom}\omega_{nom}\left(\frac{1}{\eta_{v,nom}} - 1\right)}{\Delta p_{nom}},$$

where:

- D_{nom} is the **Nominal displacement**.
- ω_{nom} is the **Nominal shaft angular velocity**.
- η_{nom} is the **Volumetric efficiency at nominal conditions**.

- Δp_{nom} is the **Nominal pressure drop**.

The torque, which is related to the motor pressure differential, is calculated as:

$$\tau_{fr} = \left(\tau_0 + k \left| \Delta p \frac{D}{D_{nom}} \right| \right) \tanh \left(\frac{4\omega}{5 \times 10^{-5} \omega_{nom}} \right),$$

where:

- τ_0 is the **No-load torque**.
- k is the friction torque vs. pressure gain coefficient at nominal displacement, which is determined from the **Mechanical efficiency at nominal conditions**, $\eta_{m,nom}$:

$$k = \frac{\tau_{fr,nom} - \tau_0}{\Delta p_{nom}}.$$

$\tau_{fr,nom}$ is the friction torque at nominal conditions:

$$\tau_{fr,nom} = (1 - \eta_{m,nom}) D_{nom} \Delta p_{nom}.$$

- Δp is the pressure drop between ports **A** and **B**.
- ω is the relative shaft angular velocity, or $\omega_R - \omega_C$.

Tabulated Data Parameterizations

When using tabulated data for motor efficiencies or losses, you can provide data for one or more of the motor operational modes. The signs of the tabulated data determine the operational regime of the block. When data is provided for less than eight operational modes, the block calculates the complementing data for the other mode(s) by extending the given data into the remaining octants.

The Tabulated data - volumetric and mechanical efficiencies parameterization

The leakage flow rate is calculated as:

$$\dot{m}_{leak} = \dot{m}_{leak,motor} \left(\frac{1 + \alpha}{2} \right) + \dot{m}_{leak,pump} \left(\frac{1 - \alpha}{2} \right),$$

where:

- $\dot{m}_{leak,pump} = (\eta_v - 1) \dot{m}_{ideal}$
- $\dot{m}_{leak,motor} = (1 - \eta_v) \dot{m}$

and η_v is the volumetric efficiency, which is interpolated from the user-provided tabulated data. The transition term, α , is

$$\alpha = \tanh \left(\frac{4\Delta p}{\Delta p_{threshold}} \right) \tanh \left(\frac{4\omega}{\omega_{threshold}} \right) \tanh \left(\frac{4D}{D_{threshold}} \right),$$

where:

- Δp is $p_A - p_B$.
- $\Delta p_{threshold}$ is the **Pressure drop threshold for motor-pump transition**.
- ω is $\omega_R - \omega_C$.

- $\omega_{\text{threshold}}$ is the **Angular velocity threshold for motor-pump transition**.

The torque is calculated as:

$$\tau_{fr} = \tau_{fr, pump} \left(\frac{1 + \alpha}{2} \right) + \tau_{fr, motor} \left(\frac{1 - \alpha}{2} \right),$$

where:

- $\tau_{fr, pump} = (\eta_m - 1)\tau$
- $\tau_{fr, motor} = (1 - \eta_m)\tau_{ideal}$

and η_m is the mechanical efficiency, which is interpolated from the user-provided tabulated data.

The Tabulated data - volumetric and mechanical losses parameterization

The leakage flow rate is calculated as:

$$\dot{m}_{leak} = \rho_{avg} q_{loss}(\Delta p, \omega, D),$$

where q_{loss} is interpolated from the **Volumetric loss table, $q_{loss}(dp, w, D)$** parameter, which is based on user-supplied data for pressure drop, shaft angular velocity, and fluid volumetric displacement.

The shaft friction torque is calculated as:

$$\tau_{fr} = \tau_{loss}(\Delta p, \omega, D),$$

where τ_{loss} is interpolated from the **Mechanical loss table, $\tau_{loss}(dp, w, D)$** parameter, which is based on user-supplied data for pressure drop, shaft angular velocity, and fluid volumetric displacement.

Input Signal Parameterization

When **Leakage and friction parameterization** is set to **Input signal - volumetric and mechanical efficiencies**, ports **EV** and **EM** are enabled. The internal leakage and shaft friction are calculated in the same way as the **Tabulated data - volumetric and mechanical efficiencies** parameterization, except that η_v and η_m are received directly at ports **EV** and **EM**, respectively.

When **Leakage and friction parameterization** is set to **Input signal - volumetric and mechanical losses**, ports **LV** and **LM** are enabled. These ports receive leakage flow and friction torque as positive physical signals. The leakage flow rate is calculated as:

$$\dot{m}_{leak} = \rho_{avg} q_{LV} \tanh\left(\frac{4\Delta p}{p_{thresh}}\right),$$

where:

- q_{LV} is the leakage flow received at port **LV**.
- p_{thresh} is the **Pressure drop threshold for motor-pump transition** parameter.

The friction torque is calculated as:

$$\tau_{fr} = \tau_{LM} \tanh\left(\frac{4\omega}{\omega_{thresh}}\right),$$

where

- τ_{LM} is the friction torque received at port **LM**.
- ω_{thresh} is the **Angular velocity threshold for motor-pump transition** parameter.

The volumetric and mechanical efficiencies range between the user-defined specified minimum and maximum values. Any values lower or higher than this range will take on the minimum and maximum specified values, respectively.

Motor Operation

The motor flow rate is:

$$\dot{m} = \dot{m}_{ideal} + \dot{m}_{leak},$$

where $\dot{m}_{ideal} = \rho_{avg} D \cdot \omega$.

The motor torque is:

$$\tau = \tau_{ideal} - \tau_{fr},$$

where $\tau_{ideal} = D \cdot \Delta p$.

The mechanical power extracted by the motor shaft is:

$$\varphi_{mech} = \tau \omega,$$

and the motor hydraulic power is:

$$\varphi_{hyd} = \frac{\Delta p \dot{m}}{\rho_{avg}}.$$

To be notified if the block is operating beyond the supplied tabulated data, you can set **Check if operating beyond the octants of supplied tabulated data** to Warning to receive a warning if this occurs, or Error to stop the simulation when this occurs. When using input signal for volumetric or mechanical losses, you can be notified if the simulation surpasses operating modes with the **Check if operating beyond motor mode** parameter.

You can also monitor motor functionality. Set **Check if pressures are less than motor minimum pressure** to Warning to receive a warning if this occurs, or Error to stop the simulation when this occurs.

Ports

Conserving

A — Liquid port

isothermal liquid

Liquid entry or exit port to the motor.

B — Liquid port

isothermal liquid

Liquid entry or exit port to the motor.

R — Mechanical port

mechanical rotational

Rotating shaft angular velocity and torque.

C — Mechanical port

mechanical rotational

Motor casing reference angular velocity and torque.

Input**D — Volumetric displacement, m^3/rad**

physical signal

Volumetric displacement of the motor, in m^3/rad , specified as a physical signal.**EV — Volumetric efficiency**

physical signal

Motor efficiency for fluid displacement, specified as a physical signal. The value must be between 0 and 1.

DependenciesTo enable this port, set **Leakage and friction parameterization** to Input signal - volumetric and mechanical efficiencies.**EM — Mechanical efficiency**

physical signal

Motor efficiency for the mechanical extraction of energy, specified as a physical signal. The value must be between 0 and 1.

DependenciesTo enable this port, set **Leakage and friction parameterization** to Input signal - volumetric and mechanical efficiencies.**LV — Leakage flow rate, m^3/s**

physical signal

Motor volumetric losses, in m^3/s , specified as a physical signal.**Dependencies**To enable this port, set **Leakage and friction parameterization** to Input signal - volumetric and mechanical losses.**LM — Friction torque, $N\cdot m$**

physical signal

Motor mechanical losses in $N\cdot m$, specified as a physical signal.**Dependencies**To enable this port, set **Leakage and friction parameterization** to Input signal - volumetric and mechanical losses.

Parameters

Leakage and friction parameterization — Method of calculating leakage flow rate and friction torque

Analytical (default) | Tabulated data - volumetric and mechanical efficiencies | Tabulated data - volumetric and mechanical losses | Input signal - volumetric and mechanical efficiencies | Input signal - volumetric and mechanical losses

Parameterization of the leakage and friction characteristics of the motor.

- In the **Analytical** parameterization, the leakage flow rate and the friction torque are calculated by analytical equations.
- In the **Tabulated data - volumetric and mechanical efficiencies** parameterization, the leakage flow rate and torque friction are calculated from the user-supplied **Pressure drop vector, dp** , **Shaft angular velocity vector, w** , and **Displacement vector, D** parameters and interpolated from the 3-D dependent **Volumetric efficiency table, $e_v(dp,w,D)$** and **Mechanical efficiency table, $e_m(dp,w,D)$** tables.
- In the **Tabulated data - volumetric and mechanical loss** parameterization, the leakage flow rate and torque friction are calculated from the user-supplied **Pressure drop vector, dp** ; **Shaft angular velocity vector, w** ; and **Displacement vector, D** parameters and interpolated from the 3-D dependent **Volumetric loss table, $q_{loss}(dp,w,D)$** and **Mechanical loss table, $torque_{loss}(dp,w,D)$** tables.
- In the **Input signal - volumetric and mechanical efficiencies** parameterization, the volumetric and mechanical efficiencies are received as physical signals at ports **EV** and **EM**, respectively.
- In the **Input signal - volumetric and mechanical loss** parameterization, the leakage flow rate and friction torque are received as physical signals at ports **LV** and **LM**, respectively.

Nominal displacement — Fixed-volume fluid displacement

30 cm³/rev (default) | scalar

Amount of fluid displaced by shaft rotating under nominal operating conditions.

Dependencies

To enable this parameter, set **Leakage and friction parameterization** to **Analytical**.

Nominal shaft angular velocity — Shaft angular velocity

188 rad/s (default) | scalar

Angular velocity of the shaft under nominal operating conditions.

Dependencies

To enable this parameter, set **Leakage and friction parameterization** to **Analytical**.

Nominal pressure drop — Pressure drop between fluid entry and exit

10 MPa (default) | scalar

Motor pressure drop between the fluid entry and exit under nominal operating conditions.

Dependencies

To enable this parameter, set **Leakage and friction parameterization** to **Analytical**.

Volumetric efficiency at nominal conditions – Ratio of actual flow rate to ideal flow rate at nominal conditions

0.92 (default) | positive scalar in the range of (0,1]

Ratio of actual flow rate to ideal flow rate at nominal conditions.

DependenciesTo enable this parameter, set **Leakage and friction parameterization** to Analytical.**No-load torque – Baseline torque**

0 N*m (default) | scalar

Minimum value of torque to overcome seal friction and induce shaft motion.

DependenciesTo enable this parameter, set **Leakage and friction parameterization** to Analytical.**Mechanical efficiency at nominal conditions – Ratio of actual to ideal mechanical power**

0.88 (default) | positive scalar

Ratio of actual mechanical power to ideal mechanical power at nominal conditions.

DependenciesTo enable this parameter, set **Leakage and friction parameterization** to Analytical.**Pressure drop vector, dp – Vector of pressure data for tabulated data parameterization**

[.1, 1, 2] MPa (default) | 1-by-n vector

Vector of pressure differential values for the tabular parameterization of leakage and torque friction. This vector forms an independent axis with the **Shaft angular velocity vector, w** and the **Displacement vector, D** parameters for the 3-D dependent **Volumetric efficiency table, e_v(dp,w,D)** and **Mechanical efficiency table, e_m(dp,w,D)** parameters. The vector elements must be listed in ascending order.

DependenciesTo enable this parameter, set **Leakage and friction parameterization** to either:

- Tabulated data - volumetric and mechanical efficiencies
- Tabulated data - volumetric and mechanical losses

Shaft angular velocity vector, w – Vector of angular velocity data for tabulated data parameterization

[25, 50, 100, 200, 300, 400] rad/s (default) | 1-by-n vector

Vector of angular velocity data for the tabular parameterization of leakage and torque friction. This vector forms an independent axis with the **Shaft angular velocity vector, w** and the **Displacement vector, D** parameters for the 3-D dependent **Volumetric efficiency table, e_v(dp,w,D)** and **Mechanical efficiency table, e_m(dp,w,D)** parameters. The vector elements must be listed in ascending order.

Dependencies

To enable this parameter, set **Leakage and friction parameterization** to either:

- Tabulated data - volumetric and mechanical efficiencies
- Tabulated data - volumetric and mechanical losses

Displacement vector, D – Vector of displacement volumes for tabulated data parameterization

`[-30, -19, 19, 30]` cm³/s (default) | 1-by-*n* vector

Vector of volumetric displacement data for the tabular parameterization of leakage and torque friction. This vector forms an independent axis with the **Shaft angular velocity vector, w** and the **Pressure drop vector, dp** parameters for the 3-D dependent **Volumetric efficiency table, e_v(dp,w,D)** and **Mechanical efficiency table, e_m(dp,w,D)** parameters. The vector elements must be listed in ascending order.

Dependencies

To enable this parameter, set **Leakage and friction parameterization** to either:

- Tabulated data - volumetric and mechanical efficiencies
- Tabulated data - volumetric and mechanical losses

Volumetric efficiency table, e_v(dp,w,D) – Volumetric efficiency for tabulated data parameterization

`repmat([.816, .908, .954, .977, .981, .984; .325, .663, .831, .916, .925, .946; .137, .568, .78, .892, .893, .91], 1, 1, 4)` (default) | *M*-by-*N*-by-*P* matrix

M-by-*N*-by-*P* matrix of volumetric efficiencies at the specified fluid pressure drop, shaft angular velocity, and volumetric displacement. Linear interpolation is employed between table elements. *M*, *N*, and *P* are the sizes of the corresponding vectors:

- *M* is the number of vector elements in the **Pressure drop vector, dp** parameter.
- *N* is the number of vector elements in the **Shaft angular velocity vector, w** parameter.
- *P* is the number of vector elements in the **Displacement vector, D** parameter.

Dependencies

To enable this parameter, set **Leakage and friction parameterization** to Tabulated data - volumetric and mechanical efficiencies.

Mechanical efficiency table, e_m(dp,w,D) – Mechanical efficiency for tabulated data parameterization

`repmat([.996, .996, .996, .996, .996, .996; .988, .989, .989, .989, .989, .99; .981, .981, .982, .982, .983, .984], 1, 1, 4)` (default) | *M*-by-*N*-by-*P* matrix

M-by-*N*-by-*P* matrix of mechanical efficiencies at the specified fluid pressure drop, shaft angular velocity, and displacement. Linear interpolation is employed between table elements. *M*, *N*, and *P* are the sizes of the corresponding vectors:

- *M* is the number of vector elements in the **Pressure drop vector, dp** parameter.
- *N* is the number of vector elements in the **Shaft angular velocity vector, w** parameter.

- P is the number of vector elements in the **Displacement vector, D** parameter.

Dependencies

To enable this parameter, set **Leakage and friction parameterization** to Tabulated data - volumetric and mechanical efficiencies.

Volumetric loss table, $q_loss(dp,w,D)$ — Volumetric losses for tabulated data parameterization

```
repmat([.023, .023, .023, .023, .0285, .032; .0844, .0842, .0845, .084, .1125, .108; .1079, .108, .11, .108, .1605, .18] * 1e-3, 1, 1, 4) (default) | M-by-N-by-P matrix
```

M -by- N -by- P matrix of volumetric leakage at the specified fluid pressure drop, shaft angular velocity, and displacement. Linear interpolation is employed between table elements. M , N , and P are the sizes of the corresponding vectors:

- M is the number of vector elements in the **Pressure drop vector, dp** parameter.
- N is the number of vector elements in the **Shaft angular velocity vector, w** parameter.
- P is the number of vector elements in the **Displacement vector, D** parameter.

Dependencies

To enable this parameter, set **Leakage and friction parameterization** to Tabulated data - volumetric and mechanical losses.

Mechanical loss table, $torque_loss(dp,w,D)$ — Mechanical losses for tabulated data parameterization

```
repmat([.002, .002, .002, .002, .002, .002; .0607, .0556, .0556, .0556, .0556, .0505; .1937, .1937, .1833, .1833, .1729, .1626], 1, 1, 4) N*m (default) | M-by-N-by-P matrix
```

M -by- N -by- P matrix of mechanical losses at the specified fluid pressure drop and shaft angular velocity. Linear interpolation is employed between table elements. M , N , and P are the sizes of the correlated vectors:

- M is the number of vector elements in the **Pressure drop vector, dp** parameter.
- N is the number of vector elements in the **Shaft angular velocity vector, w** parameter.
- P is the number of vector elements in the **Displacement vector, D** parameter.

Dependencies

To enable this parameter, set **Leakage and friction parameterization** to Tabulated data - volumetric and mechanical losses.

Minimum volumetric efficiency — Minimum value of volumetric efficiency

1e-3 (default) | positive scalar in the range of (0,1]

Minimum value of volumetric efficiency. If the input signal is below this value, the volumetric efficiency is set to the minimum volumetric efficiency.

Dependencies

To enable this parameter, set **Leakage and friction parameterization** to Input signal - volumetric and mechanical efficiencies.

Maximum volumetric efficiency – Maximum value of volumetric efficiency

1 (default) | positive scalar in the range of (0,1]

Maximum value of volumetric efficiency. If the input signal is above this value, the volumetric efficiency is set to the maximum volumetric efficiency.

Dependencies

To enable this parameter, set **Leakage and friction parameterization** to Input signal - volumetric and mechanical efficiencies.

Minimum mechanical efficiency – Minimum value of mechanical efficiency

1e-3 (default) | positive scalar in the range of (0,1]

Minimum value of mechanical efficiency. If the input signal is below this value, the mechanical efficiency is set to the minimum mechanical efficiency.

Dependencies

To enable this parameter, set **Leakage and friction parameterization** to Input signal - volumetric and mechanical efficiencies.

Maximum mechanical efficiency – Maximum value of mechanical efficiency

1 (default) | positive scalar in the range of (0,1]

Maximum value of mechanical efficiency. If the input signal is above this value, the mechanical efficiency is set to the maximum mechanical efficiency.

Dependencies

To enable this parameter, set **Leakage and friction parameterization** to Input signal - volumetric and mechanical efficiencies.

Pressure drop threshold for motor-pump transition – Pressure threshold for mode transition

1e-3 MPa (default) | positive scalar

Motor pressure drop that indicates the transition threshold between motor and pump functionality. A transition region is defined around 0 MPa between the positive and negative values of the pressure drop threshold. Within this transition region, the computed leakage flow rate and friction torque are adjusted according to the transition term α to ensure smooth transition from one mode to the other.

Dependencies

To enable this parameter, set **Leakage and friction parameterization** to either:

- Tabulated data - volumetric and mechanical efficiencies
- Input signal - volumetric and mechanical efficiencies
- Input signal - volumetric and mechanical losses

Angular velocity threshold for motor-pump transition – Angular velocity threshold for mode transition

10 rad/s (default) | positive scalar

Shaft angular velocity that indicates the transition threshold between motor and pump functionality. A transition region is defined around 0 rad/s between the positive and negative values of the angular

velocity threshold. Within this transition region, the computed leakage flow rate and friction torque are adjusted according to the transition term α to ensure smooth transition from one mode to the other.

Dependencies

To enable this parameter, set **Leakage and friction parameterization** to:

- Tabulated data - volumetric and mechanical efficiencies
- Input signal - volumetric and mechanical efficiencies
- Input signal - volumetric and mechanical losses

Displacement threshold for motor-pump transition — Displacement threshold for mode transition

0.1 cm³/s (default) | positive scalar

Volumetric displacement that indicates the transition threshold between motor and pump functionality. A transition region is defined around 0 cm³/s between the positive and negative values of the displacement threshold. Within this transition region, the computed leakage flow rate and friction torque are adjusted according to the transition term α to ensure smooth transition from one mode to the other. It is also used to transition the ideal mass flow rate when the sign of **D** changes.

Check if operating beyond the octants of supplied tabulated data — Whether to notify if extents of supplied data are surpassed

None (default) | Warning | Error

Whether to notify if the extents of the supplied data are surpassed. Select Warning to be notified when the block uses values beyond the supplied data range. Select Error to stop the simulation when the block uses values beyond the supplied data range.

Dependencies

To enable this parameter, set **Leakage and friction parameterization** to:

- Tabulated data - volumetric and mechanical efficiencies
- Tabulated data - volumetric and mechanical losses

Check if operating beyond motor mode — Whether to notify if block operates outside of the motor mode functionality

None (default) | Warning | Error

Whether to notify if the block operates outside of the motor mode functionality. Select Warning to be notified when the block operates in the forward or reverse pump modes. Select Error to stop the simulation when the block operates in the forward or reverse pump modes.

Dependencies

To enable this parameter, set **Leakage and friction parameterization** to Input signal - volumetric and mechanical losses.

Check if pressures are less than motor minimum pressure — Whether to notify if fluid exit pressure is low

None (default) | Warning | Error

Whether to notify if the fluid at port **A** or **B** experiences low pressure. Select **Warning** to be notified when the pressure falls below a minimum specified value. Select **Error** to stop the simulation when the pressure falls below a minimum specified value.

The parameter helps identify potential conditions for cavitation, when the fluid pressure falls below the fluid vapor pressure.

Motor minimum pressure — Lower threshold of acceptable pressure at the motor outlet

0.101325 MPa (default) | positive scalar

Lower threshold of acceptable pressure at the motor inlet or outlet.

Dependencies

To enable this parameter, set **Check if pressures are less than motor minimum pressure** to either:

- Warning
- Error

See Also

Variable-Displacement Motor (TL) | Variable-Displacement Pump (IL) | Fixed-Displacement Motor (IL)

Topics

Introduced in R2020a

Variable-Displacement Motor (TL)

Variable-displacement bidirectional thermal liquid motor

Library: Simscape / Fluids / Thermal Liquid / Pumps & Motors



Description

The Variable-Displacement Motor block represents a device that extracts power from a thermal liquid network and delivers it to a mechanical rotational network. The motor displacement varies during simulation according to the physical signal input specified at port **D**.

Ports **A** and **B** represent the motor inlets. Ports **R** and **C** represent the motor drive shaft and case. During normal operation, a pressure drop from port **A** to port **B** causes a positive flow rate from port **A** to port **B** and a positive rotation of the motor shaft relative to the motor case. This operation mode is referred to here as *forward motor*.

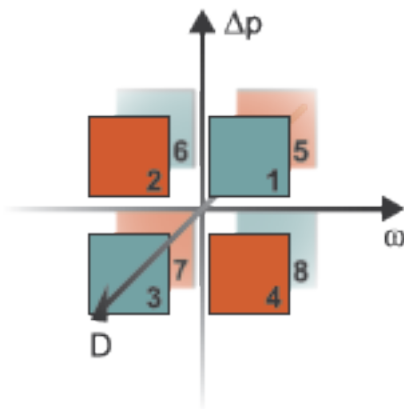

Operation Modes

The block has eight modes of operation. The working mode depends on the pressure gain from port **A** to port **B**, $\Delta p = p_B - p_A$; the angular velocity, $\omega = \omega_R - \omega_C$; and the fluid volumetric displacement at port **D**. The figure above maps these modes to the octants of a Δp - ω - D chart:

- Mode 1, *Forward Motor*: Flow from port **A** to port **B** causes a pressure decrease from **A** to **B** and a positive shaft angular velocity.
- Mode 2, *Reverse Pump*: Negative shaft angular velocity causes a pressure increase from port **B** to port **A** and flow from **B** to port **A**.
- Mode 3, *Reverse Motor*: Flow from port **B** to port **A** causes a pressure decrease from **B** to **A** and a negative shaft angular velocity.

- Mode 4, *Forward Pump*: Positive shaft angular velocity causes a pressure increase from port **A** to port **B** and flow from **A** to **B**.
- Mode 5, *Reverse Pump*: Positive shaft angular velocity causes a pressure increase from port **B** to port **A** and flow from **B** to **A**.
- Mode 6, *Forward Motor*: Flow from port **A** to port **B** causes a pressure decrease from **A** to **B** and a positive shaft angular velocity.
- Mode 7, *Forward Pump*: Negative shaft angular velocity causes a pressure increase from port **A** to port **B** and flow from **A** to **B**.
- Mode 8, *Reverse Motor*: Flow from **B** to **A** causes a pressure decrease from **B** to **A** and positive shaft angular velocity.

The response time of the motor is considered negligible in comparison with the system response time. The motor is assumed to reach steady state nearly instantaneously and is treated as a quasi-steady component.

Flow Rate and Driving Torque

The mass flow rate generated at the motor is

$$\dot{m} = \dot{m}_{\text{Ideal}} + \dot{m}_{\text{Leak}},$$

where:

- \dot{m} is the actual mass flow rate.
- \dot{m}_{Ideal} is the ideal mass flow rate.
- \dot{m}_{Leak} is the internal leakage mass flow rate.

The torque generated at the motor is

$$\tau = \tau_{\text{Ideal}} - \tau_{\text{Friction}},$$

where:

- τ is the actual torque.
- τ_{Ideal} is the ideal torque.
- τ_{Friction} is the friction torque.

Ideal Flow Rate and Ideal Torque

The ideal mass flow rate is

$$\dot{m}_{\text{Ideal}} = \rho D_{\text{Sat}} \omega,$$

and the ideal generated torque is

$$\tau_{\text{Ideal}} = D_{\text{Sat}} \Delta p,$$

where:

- ρ is the average of the fluid densities at thermal liquid ports **A** and **B**.
- D_{Sat} is a smoothed displacement computed so as to remove numerical discontinuities between negative and positive displacements.

- ω is the shaft angular velocity.
- Δp is the pressure drop from inlet to outlet.

The saturation displacement is defined as:

$$D_{\text{Sat}} = \begin{cases} \sqrt{D^2 + D_{\text{Threshold}}^2}, & D \geq 0 \\ -\sqrt{D^2 + D_{\text{Threshold}}^2}, & D < 0 \end{cases}.$$

where:

- D is the displacement specified at physical signal port **D**.
- $D_{\text{Threshold}}$ is the specified value of the **Displacement threshold for motor-pump transition** block parameter.

Leakage and friction parameterization

You can parameterize leakage and friction analytically, using tabulated efficiencies or losses, or by input efficiencies or input losses.

Analytical

When you set **Leakage and friction parameterization** to Analytical leakage flow rate is

$$\dot{m}_{\text{Leak}} = \frac{K_{\text{HP}} \rho_{\text{Avg}} \Delta p}{\mu_{\text{Avg}}},$$

and the friction torque is

$$\tau_{\text{Friction}} = \left(\tau_0 + K_{\text{TP}} |\Delta p| \frac{|D_{\text{Sat}}|}{D_{\text{Nom}}} \tanh \left(\frac{4\omega}{(5e - 5)\omega_{\text{Nom}}} \right) \right),$$

where:

- K_{HP} is the Hagen-Poiseuille coefficient for laminar pipe flows. This coefficient is computed from the specified nominal parameters.
- μ is the dynamic viscosity of the thermal liquid, taken here as the average of its values at the thermal liquid ports.
- k is the friction torque vs. pressure gain coefficient at nominal displacement, which is determined from the **Mechanical efficiency at nominal conditions**, $\eta_{m,nom}$:

$$k = \frac{\tau_{fr,nom} - \tau_0}{\Delta p_{nom}}.$$

$\tau_{fr,nom}$ is the friction torque at nominal conditions:

$$\tau_{fr,nom} = (1 - \eta_{m,nom}) D_{nom} \Delta p_{nom}.$$

- D_{Nom} is the specified value of the **Nominal Displacement** block parameter.
- τ_0 is the specified value of the **No-load torque** block parameter.
- ω_{Nom} is the specified value of the **Nominal shaft angular velocity** block parameter.
- Δp_{Nom} is the specified value of the **Nominal pressure drop** block parameter. This is the pressure drop at which the nominal volumetric efficiency is specified.

The Hagen-Poiseuille coefficient is determined from nominal fluid and component parameters through the equation

$$K_{HP} = \frac{D_{Nom}\omega_{Nom}\mu_{Nom}\left(\frac{1}{\eta_{v,Nom}} - 1\right)}{\Delta p_{Nom}},$$

where:

- ω_{Nom} is the specified value of the **Nominal shaft angular velocity** parameter. This is the angular velocity at which the nominal volumetric efficiency is specified.
- μ_{Nom} is the specified value of the **Nominal Dynamic viscosity** block parameter. This is the dynamic viscosity at which the nominal volumetric efficiency is specified.
- $\eta_{v,Nom}$ is the specified value of the **Volumetric efficiency at nominal conditions** block parameter. This is the volumetric efficiency corresponding to the specified nominal conditions.

Tabulated Efficiencies

When you set **Leakage and friction parameterization** to Tabulated data - volumetric and mechanical efficiencies, the leakage flow rate is

$$\dot{m}_{Leak} = \dot{m}_{Leak,Pump}\frac{(1+\alpha)}{2} + \dot{m}_{Leak,Motor}\frac{(1-\alpha)}{2},$$

and the friction torque is

$$\tau_{Friction} = \tau_{Friction,Pump}\frac{1+\alpha}{2} + \tau_{Friction,Motor}\frac{1-\alpha}{2},$$

where:

- α is a numerical smoothing parameter for the motor-pump transition.
- $\dot{m}_{Leak,Motor}$ is the leakage flow rate in motor mode.
- $\dot{m}_{Leak,Pump}$ is the leakage flow rate in pump mode.
- $\tau_{Friction,Motor}$ is the friction torque in motor mode.
- $\tau_{Friction,Pump}$ is the friction torque in pump mode.

The smoothing parameter α is given by the hyperbolic tangent function

$$\alpha = \tanh\left(\frac{4\Delta p}{\Delta p_{Threshold}}\right) \cdot \tanh\left(\frac{4\omega}{\omega_{Threshold}}\right) \cdot \tanh\left(\frac{4D}{D_{Threshold}}\right),$$

where:

- $\Delta p_{Threshold}$ is the specified value of the **Pressure gain threshold for pump-motor transition** block parameter.
- $\omega_{Threshold}$ is the specified value of the **Angular velocity threshold for pump-motor transition** block parameter.
- $D_{Threshold}$ is the specified value of the **Angular velocity threshold for motor-pump transition** block parameter.

The leakage flow rate is calculated from the volumetric efficiency, a quantity that is specified in tabulated form over the Δp - ω - D domain via the **Volumetric efficiency table** block parameter. When

operating in pump mode (quadrants **1** and **3** of the Δp - ω - D chart shown in the “Operation Modes” on page 1-672 figure), the leakage flow rate is:

$$\dot{m}_{\text{Leak,Pump}} = (1 - \eta_v)\dot{m}_{\text{Ideal}},$$

where η_v is the volumetric efficiency, obtained either by interpolation or extrapolation of the tabulated data. Similarly, when operating in motor mode (quadrants **2** and **4** of the Δp - ω - D chart), the leakage flow rate is:

$$\dot{m}_{\text{Leak,Motor}} = -(1 - \eta_v)\dot{m}.$$

The friction torque is similarly calculated from the mechanical efficiency, a quantity that is specified in tabulated form over the Δp - ω - D domain via the **Mechanical efficiency table** block parameter. When operating in pump mode (quadrants **1** and **3** of the Δp - ω - D chart):

$$\tau_{\text{Friction,Pump}} = (1 - \eta_m)\tau,$$

where η_m is the mechanical efficiency, obtained either by interpolation or extrapolation of the tabulated data. Similarly, when operating in motor mode (quadrants **2** and **4** of the Δp - ω - D chart):

$$\tau_{\text{Friction,Motor}} = -(1 - \eta_m)\tau_{\text{Ideal}}.$$

Tabulated Losses

When you set **Leakage and friction parameterization** to **Tabulated data - volumetric and mechanical losses**, the leakage (volumetric) flow rate is specified directly in tabulated form over the Δp - ω - D domain:

$$q_{\text{Leak}} = q_{\text{Leak}}(\Delta p, \omega, D_{\text{Sat}}).$$

The mass flow rate due to leakage is calculated from the volumetric flow rate:

$$\dot{m}_{\text{Leak}} = \rho q_{\text{Leak}}.$$

The friction torque is similarly specified in tabulated form:

$$\tau_{\text{Friction}} = \tau_{\text{Friction}}(\Delta p, \omega, D_{\text{Sat}}),$$

where $q_{\text{Leak}}(\Delta p, \omega)$ and $\tau_{\text{Friction}}(\Delta p, \omega)$ are the volumetric and mechanical losses, obtained through interpolation or extrapolation of the tabulated data specified via the **Volumetric loss table** and **Mechanical loss table** block parameters.

Input Efficiencies

When you set **Leakage and friction parameterization** to **Input signal - volumetric and mechanical efficiencies**, the leakage flow rate and friction torque calculations are identical to the **Tabulated data - volumetric and mechanical efficiencies** setting. The volumetric and mechanical efficiency lookup tables are replaced with physical signal inputs that you specify through ports **EV** and **EM**.

The efficiencies are positive quantities with value between 0 and 1. Input values outside of these bounds are set equal to the nearest bound (0 for inputs smaller than 0, 1 for inputs greater than 1). In other words, the efficiency signals are saturated at 0 and 1.

Input Losses

When you set **Leakage and friction parameterization** to **Input signal - volumetric and mechanical efficiencies**, the leakage flow rate and friction torque calculations are identical to

the Tabulated data - volumetric and mechanical efficiencies setting. The volumetric and mechanical loss lookup tables are replaced with physical signal inputs that you specify through ports **IV** and **LM**.

The block ignores the sign of the input. The block sets the signs automatically from the operating conditions established during simulation—more precisely, from the Δp - ω quadrant in which the component happens to be operating.

Energy Balance

Mechanical work done by the motor is associated with an energy exchange. The governing energy balance equation is:

$$\phi_A + \phi_B - P_{hydro} = 0,$$

where:

- Φ_A and Φ_B are energy flow rates at ports **A** and **B**, respectively.
- P_{hydro} is a function of the pressure difference between motor ports: $P_{hydro} = \Delta p \frac{\dot{m}}{\rho}$.

The motor mechanical power is generated due to torque, τ , and angular velocity, ω :

$$P_{mech} = \tau\omega.$$

Assumptions

- Fluid compressibility is negligible.
- Loading on the motor shaft due to inertia, friction, and spring forces is negligible.

Ports

Input

D – Displacement volume, cm³/rev

physical signal

Physical signal input port for the volume of fluid displaced per rotation. A smoothing function eases the transition between positive and negative input values.

EV – Volumetric efficiency, unitless

physical signal

Physical signal input port for the volumetric efficiency coefficient. The input signal has an upper bound at the **Maximum volumetric efficiency** parameter value and a lower bound at the **Minimum volumetric efficiency** parameter value.

Dependencies

This port is exposed only when the block variant is set to Input efficiencies.

EM – Mechanical efficiency, unitless

physical signal

Physical signal input port for the mechanical efficiency coefficient. The input signal has an upper bound at the **Maximum mechanical efficiency** parameter value and a lower bound at the **Minimum mechanical efficiency** parameter value.

Dependencies

This port is exposed only when the block variant is set to Input efficiencies.

LV — Volumetric loss, m³/s

physical signal

Physical signal input port for the volumetric loss, defined as the internal leakage flow rate between the motor inlets.

Dependencies

This port is exposed only when the block variant is set to Input losses.

LM — Mechanical loss, N*m

physical signal

Physical signal input port for the mechanical loss, defined as the friction torque on the rotating motor shaft.

Dependencies

This port is exposed only when the block variant is set to Input losses.

Conserving**A — Motor inlet**

thermal liquid

Thermal liquid conserving port representing the motor inlet.

B — Motor outlet

thermal liquid

Thermal liquid conserving port representing the motor outlet.

C — Motor Case

mechanical rotational

Mechanical rotational conserving port representing the motor case.

R — Motor Shaft

mechanical rotational

Mechanical rotational conserving port representing the rotational motor shaft.

Parameters

Leakage and friction parameterization — Parameterization of leakage flow rate and friction torque

Analytical (default) | Tabulated data - volumetric and mechanical efficiencies | Tabulated data - volumetric and mechanical losses | Input signal - volumetric and mechanical efficiencies | Input signal - volumetric and mechanical losses

Method to compute flow-rate and torque losses due to internal leaks and friction. When you select **Analytical**, the block parameters are generally available from component data sheets. When you select **Tabulated data - volumetric and mechanical efficiencies** or **Tabulated data - volumetric and mechanical losses**, the block uses lookup tables to map pressure drop, angular velocity, and displacement to component efficiencies or losses.

When you select **Input signal - volumetric and mechanical efficiencies** or **Input signal - volumetric and mechanical losses**, the block performs the leakage flow rate and friction torque calculations the same as the **Tabulated data - volumetric and mechanical efficiencies** or **Tabulated data - volumetric and mechanical losses** settings, respectively, and the block enables the physical signal ports, **EV** and **EM**. You use these ports to specify the volumetric and mechanical efficiency.

Nominal displacement — Displacement at which to specify the volumetric efficiency

30 cm³/rev (default) | positive scalar

Fluid displacement for a given volumetric efficiency. These values are typically available at standard operating conditions in the manufacturer data sheet. The block uses this parameter to calculate the leakage flow rate and friction torque.

Nominal shaft angular velocity — Shaft angular velocity for given volumetric efficiency

188 rpm (default) | scalar

Angular velocity of the rotary shaft that corresponds to the given volumetric efficiency. These values are typically available at standard operating conditions in the manufacturer data sheet. The block uses this parameter to calculate the leakage flow rate and friction torque.

Dependencies

To enable this parameter, set **Leakage and friction parameterization** to **Analytical**.

Nominal pressure drop — Pressure drop for corresponding volumetric efficiency

10 MPa (default) | scalar

Pressure drop that corresponds to the given volumetric efficiency. These values are typically available at standard operating conditions in manufacturer data sheet. The block uses this parameter to calculate the internal leakage flow rate.

Dependencies

To enable this parameter, set **Leakage and friction parameterization** to **Analytical**.

Nominal dynamic viscosity — Dynamic viscosity at which to specify the volumetric efficiency

0.9 cP (default) | scalar

Dynamic viscosity of the hydraulic fluid for the given volumetric efficiency. These values are typically available at standard operating conditions in manufacturer data sheet. The block uses this parameter to calculate the internal leakage flow rate.

Dependencies

To enable this parameter, set **Leakage and friction parameterization** to Analytical.

Volumetric efficiency at nominal conditions – Volumetric efficiency at the specified nominal conditions

0.92 (default) | scalar in the range (0,1)

Volumetric efficiency for the given conditions. The block defines the volumetric efficiency as the ratio of actual to ideal volumetric flow rates. These values are typically available at standard operating conditions in manufacturer data sheet. The block uses this parameter to calculate the internal leakage flow rate.

Dependencies

To enable this parameter, set **Leakage and friction parameterization** to Analytical.

Mechanical efficiency at nominal conditions – Ratio of actual to ideal mechanical power

0.88 (default) | positive scalar

Ratio of actual mechanical power to ideal mechanical power at nominal conditions.

Dependencies

To enable this parameter, set **Leakage and friction parameterization** to Analytical.

No-load torque – Minimum torque required to induce shaft rotation

0 N*m (default) | scalar

Torque to overcome the seal friction and induce rotation of the mechanical shaft. This torque is the load-independent component of the total friction torque.

Dependencies

To enable this parameter, set **Leakage and friction parameterization** to Analytical.

Pressure drop vector for efficiencies, dp – Pressure drops for given volumetric and mechanical efficiencies

[.1, 1, 2] MPa (default) | vector

Pressure drops for the corresponding tabular efficiency data. The vector must be at least two elements in strictly increasing order.

You can specify the data for a single quadrant, (ω , Δp , D). Refer to the block description for the operation modes corresponding to the various quadrants.

Dependencies

To enable this parameter, set **Leakage and friction parameterization** to Tabulated data - volumetric and mechanical efficiencies.

Shaft angular velocity vector for efficiencies, w – Angular velocities at which to specify the volumetric and mechanical efficiencies

[25, 50, 100, 200, 300, 400] rad/s | vector

Shaft angular velocities for the corresponding tabular efficiency data. The vector must be at least two elements in strictly increasing order.

You can specify the data for a single quadrant, $(\omega, \Delta p, D)$. Refer to the block description for the operation modes corresponding to the various quadrants.

Dependencies

To enable this parameter, set **Leakage and friction parameterization** to Tabulated data - volumetric and mechanical efficiencies.

Displacement vector for efficiencies, D – Displacements at which to specify the volumetric and mechanical efficiencies

[-30, -19, 19, 30] cm³/rev (default)

Displacements at which to specify the efficiency tabular data. The vector must be at least two elements in strictly increasing order.

You can specify the data for a single quadrant, $(\omega, \Delta p, D)$. Refer to the block description for the operation modes corresponding to the various quadrants.

Dependencies

To enable this parameter, set **Leakage and friction parameterization** to Tabulated data - volumetric and mechanical efficiencies.

Volumetric efficiency table, $e_v(dp, w)$ – Volumetric efficiencies for given pressure drops, angular velocities, and displacements

repmat([.816, .908, .954, .977, .981, .984; .325, .663, .831, .916, .925, .946; .137, .568, .78, .892, .893, .91], 1, 1, 4) | matrix

Volumetric efficiencies at the specified fluid pressure drops, shaft angular velocities, and displacements. The efficiencies must be in the range of 0-1. M , N , and L are the sizes of the specified lookup-table vectors:

- M is the number of vector elements in the **Pressure drop vector for efficiencies, dp** parameter.
- N is the number of vector elements in the **Shaft angular velocity vector for efficiencies, w** parameter.
- L is the number of vector elements in the **Displacement vector for efficiencies, D** parameter.

You can specify the data for a single quadrant, $(\omega, \Delta p, D)$. Refer to the block description for the operation modes corresponding to the various quadrants.

Dependencies

To enable this parameter, set **Leakage and friction parameterization** to Tabulated data - volumetric and mechanical efficiencies.

Mechanical efficiency table, $e_m(dp, w)$ – Mechanical efficiencies for given pressure drops, angular velocities, and displacements

repmat([.996, .996, .996, .996, .996, .996; .988, .989, .989, .989, .989, .99; .981, .981, .982, .982, .983, .984], 1, 1, 4) | matrix

Mechanical efficiencies corresponding to the specified fluid pressure drops, shaft angular velocities, and displacements. The efficiencies must be in the range of 0–1. M , N , and L are the sizes of the specified lookup-table vectors:

- M is the number of vector elements in the **Pressure drop vector for efficiencies, \mathbf{dp}** parameter.
- N is the number of vector elements in the **Shaft angular velocity vector for efficiencies, \mathbf{w}** parameter.
- L is the number of vector elements in the **Displacement vector for efficiencies, \mathbf{D}** parameter.

You can specify the data for a single quadrant, $(\omega, \Delta p, D)$. Refer to the block description for the operation modes corresponding to the various quadrants.

Dependencies

To enable this parameter, set **Leakage and friction parameterization** to Tabulated data - volumetric and mechanical efficiencies.

Pressure drop vector for losses, \mathbf{dp} — Pressure drop for corresponding losses

[.1, 1, 2] MPa (default)

Pressure drops for the corresponding tabular loss data. The vector must be at least two elements in strictly increasing order.

You can specify the data for a single quadrant, $(\omega, \Delta p, D)$. Refer to the block description for the operation modes corresponding to the various quadrants.

Dependencies

To enable this parameter, set **Leakage and friction parameterization** to Tabulated data - volumetric and mechanical losses.

Shaft angular velocity vector for losses, \mathbf{w} — Shaft speed for corresponding losses

[25, 50, 100, 200, 300, 400] rad/s (default)

Shaft angular velocity for the corresponding tabular loss data. The vector must be at least two elements in strictly increasing order.

You can specify the data for a single quadrant, $(\omega, \Delta p, D)$. Refer to the block description for the operation modes corresponding to the various quadrants.

Dependencies

To enable this parameter, set **Leakage and friction parameterization** to Tabulated data - volumetric and mechanical losses.

Displacement vector for losses, \mathbf{D} — Displacements at which to specify the volumetric and mechanical losses

[-30, -19, 19, 30] cm³/rev (default)

Displacements at which to specify the loss tabular data. The vector must be at least two elements in strictly increasing order.

You can specify the data for a single quadrant, $(\omega, \Delta p, D)$. Refer to the block description for the operation modes corresponding to the various quadrants.

Dependencies

To enable this parameter, set **Leakage and friction parameterization** to Tabulated data - volumetric and mechanical losses.

Volumetric loss table, $q_loss(dp,w)$ — Internal leakage flow rates for corresponding pressure drops, angular velocities, and displacements

```
repmat([.0282, .0253, .0241, .0235, .0291, .0325; .2596, .1271, .1017, .0917, .1216, .1142; .7874, .1901, .141, .1211, .1797, .1978] * 1e-3, 1, 1, 4) m^3/s
```

Volumetric losses at the specified fluid pressure drops, shaft angular velocities, and displacements. The block defines volumetric loss the internal leakage volumetric flow rate between port **A** and port **B**. M and N are the sizes of the specified lookup-table vectors:

- M is the number of vector elements in the **Pressure drop vector for losses, dp** parameter.
- N is the number of vector elements in the **Shaft angular velocity vector for losses, w** parameter.

You can specify the data for a single quadrant, $(\omega, \Delta p, D)$. Refer to the block description for the operation modes corresponding to the various quadrants.

Dependencies

To enable this parameter, set **Leakage and friction parameterization** to Tabulated data - volumetric and mechanical losses.

Mechanical loss table, $torque_loss(dp,w)$ — Friction torques for the corresponding pressure drops, angular velocities, and displacements

```
repmat([.002, .002, .002, .002, .002, .002; .06, .055, .055, .055, .055, .05; .19, .19, .18, .18, .17, .16], 1, 1, 4) N*m
```

Mechanical losses for the given pressure drops, shaft angular velocities, and displacements. The block defines mechanical loss as the friction torque due to seals and internal components. M and N are the sizes of the specified lookup-table vectors:

- M is the number of vector elements in the **Pressure drop vector for losses, dp** parameter.
- N is the number of vector elements in the **Shaft angular velocity vector for losses, w** parameter.

You can specify the data for a single quadrant, $(\omega, \Delta p)$. Refer to the block description for the operation modes corresponding to the various quadrants. The tabulated data for the mechanical losses must obey the convention in the figure, with positive values at positive angular velocities and negative values at negative angular velocities.

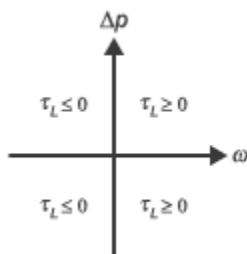

Dependencies

To enable this parameter, set **Leakage and friction parameterization** to Tabulated data - volumetric and mechanical losses.

Minimum volumetric efficiency – Lower saturation bound on the volumetric efficiency input signal

1e-3 (default) | scalar in the range (0,1)

Smallest allowed value of the volumetric efficiency. The input from the physical signal port **EV** saturates inputs below this value.

Dependencies

To enable this parameter, set **Leakage and friction parameterization** to Input signal - volumetric and mechanical efficiencies.

Maximum volumetric efficiency – Upper saturation bound on the volumetric efficiency input signal

1 (default) | scalar in the range (0,1)

Largest allowed value of the volumetric efficiency. The input from the physical signal port **EV** saturates inputs above this value.

Dependencies

To enable this parameter, set **Leakage and friction parameterization** to Input signal - volumetric and mechanical efficiencies.

Minimum mechanical efficiency – Lower saturation bound on the volumetric efficiency input signal

1e-3 (default) | scalar in the range (0,1)

Smallest allowed value of the mechanical efficiency. The input from the physical signal port **EM** saturates inputs below this value.

Dependencies

To enable this parameter, set **Leakage and friction parameterization** to Input signal - volumetric and mechanical efficiencies.

Maximum mechanical efficiency – Upper saturation bound on the volumetric efficiency input signal

1 (default) | scalar in the range (0,1)

Largest allowed value of the mechanical efficiency. The input from the physical signal port **EM** saturates inputs above this value.

Dependencies

To enable this parameter, set **Leakage and friction parameterization** to Input signal - volumetric and mechanical efficiencies.

Pressure drop threshold for motor-pump transition – Pressure drop at which to initiate a smooth transition between motor and pump modes

1e-3 MPa (default) | scalar

Pressure drop from inlet to outlet below which the block begins to transition between motoring and pumping modes. The block uses a hyperbolic tangent function to smooth the leakage flow rate and friction torque.

Dependencies

To enable this parameter, set **Leakage and friction parameterization** to Input signal - volumetric and mechanical efficiencies or Input signal - volumetric and mechanical losses.

Angular velocity threshold for motor-pump transition – Angular velocity at which to initiate a smooth transition between pump and motor modes

10 rad/s (default) | scalar

Shaft angular velocity below which the block begins to transition between motoring and pumping modes. The block uses the hyperbolic tangent function to smooth the leakage flow rate and friction torque.

Dependencies

To enable this parameter, set **Leakage and friction parameterization** to Input signal - volumetric and mechanical efficiencies or Input signal - volumetric and mechanical losses.

Cross-sectional area at ports A and B – Flow area at the component inlet and outlet

0.01 m² (default) | positive scalar

Flow area at the component inlet and outlet. The areas are assumed equal.

Check if operating beyond the octants of supplied tabulated data – Simulation warning mode for operating conditions outside the range of tabulated data

None (default) | Warning

Simulation warning mode for operating conditions outside the range of tabulated data. Select **Warning** to be notified when the fluid pressure drop, shaft angular velocity, or instantaneous displacement cross outside the specified tabular data. The warning does not cause simulation to stop.

Dependencies

To enable this parameter, set **Leakage and friction parameterization** to:

- Tabulated data - volumetric and mechanical efficiencies
- Tabulated data - volumetric and mechanical losses
- Input signal - volumetric and mechanical efficiencies
- Input signal - volumetric and mechanical losses

Check if operating outside of motor mode – Simulation warning mode for operating conditions outside motoring mode

None (default) | Warning

Simulation warning mode for operating conditions outside the motoring mode. The block generates a warning if the motor transitions to pumping mode. Select **Warning** to be notified when this transition occurs. The warning does not cause simulation to stop.

Extended Capabilities

C/C++ Code Generation

Generate C and C++ code using Simulink® Coder™.

See Also

[Fixed-Displacement Pump \(TL\)](#) | [Fixed-Displacement Motor \(TL\)](#)

Introduced in R2017b

Variable-Displacement Pressure-Compensated Pump

Hydraulic pump maintaining preset pressure at outlet by regulating its flow delivery

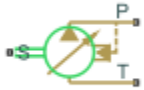

Library

Pumps and Motors

Description

The Variable-Displacement Pressure-Compensated Pump block represents a positive, variable-displacement, pressure-compensated pump of any type as a data-sheet-based model. The key parameters required to parameterize the block are the pump maximum displacement, regulation range, volumetric and total efficiencies, nominal pressure, and angular velocity. All these parameters are generally provided in the data sheets or catalogs.

The following figure shows the delivery-pressure characteristic of the pump.

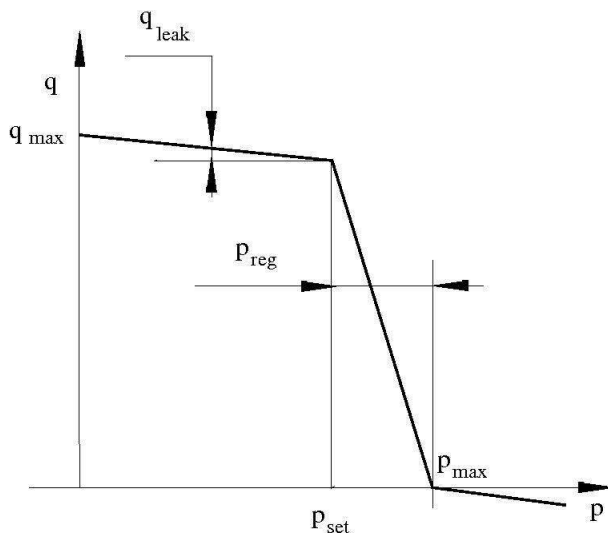

The pump tries to maintain preset pressure at its outlet by adjusting its delivery flow in accordance with the system requirements. If pressure differential across the pump is less than the setting pressure, the pump outputs its maximum delivery corrected for internal leakage. After the pressure setting has been reached, the output flow is regulated to maintain preset pressure by changing the pump's displacement. The displacement can be changed from its maximum value down to zero, depending upon system flow requirements. The pressure range between the preset pressure and the

maximum pressure, at which the displacement is zero, is referred to as regulation range. The smaller the range, the higher the accuracy at which preset pressure is maintained. The range size also affects the pump stability, and decreasing the range generally causes stability to decrease.

The variable-displacement, pressure-compensated pump is represented with the following equations:

$$q = D \cdot \omega - k_{leak} \cdot p$$

$$T = D \cdot p / \eta_{mech}$$

$$D = \begin{cases} D_{max} & \text{for } p \leq p_{set} \\ D_{max} - K(p - p_{set}) & \text{for } p_{set} < p < p_{max} \\ 0 & \text{for } p \geq p_{max} \end{cases}$$

$$p_{max} = p_{set} + p_{reg}$$

$$K = D_{max} / (p_{max} - p_{set})$$

$$k_{leak} = \frac{k_{HP}}{\nu \cdot \rho}$$

$$k_{HP} = \frac{D_{max} \cdot \omega_{nom} (1 - \eta_V) \cdot \nu_{nom} \cdot \rho_{nom}}{p_{nom}}$$

$$p = p_P - p_T$$

where

q	Pump delivery
p	Pressure differential across the pump
p_P, p_T	Gauge pressures at the block terminals
D	Pump instantaneous displacement
D_{max}	Pump maximum displacement
p_{set}	Pump setting pressure
p_{max}	Maximum pressure, at which the pump displacement is zero
T	Torque at the pump driving shaft
ω	Pump angular velocity
k_{leak}	Leakage coefficient
k_{HP}	Hagen-Poiseuille coefficient
η_V	Pump volumetric efficiency
η_{mech}	Pump mechanical efficiency
ν	Fluid kinematic viscosity
ρ	Fluid density
ρ_{nom}	Nominal fluid density
p_{nom}	Pump nominal pressure

ω_{nom}	Pump nominal angular velocity
ν_{nom}	Nominal fluid kinematic viscosity

The leakage flow is determined based on the assumption that it is linearly proportional to the pressure differential across the pump and can be computed by using the Hagen-Poiseuille formula

$$p = \frac{128\mu l}{\pi d^4} q_{leak} = \frac{\mu}{k_{HP}} q_{leak}$$

where

q_{leak}	Leakage flow
d, l	Geometric parameters of the leakage path
μ	Fluid dynamic viscosity, $\mu = \nu\rho$

The leakage flow at $p = p_{nom}$ and $\nu = \nu_{nom}$ can be determined from the catalog data

$$q_{leak} = D_{max} \cdot \omega_{nom}(1 - \eta_V)$$

which provides the formula to determine the Hagen-Poiseuille coefficient

$$k_{HP} = \frac{D_{max} \cdot \omega_{nom}(1 - \eta_V) \cdot \nu_{nom} \cdot \rho_{nom}}{p_{nom}}$$

The pump mechanical efficiency is not usually available in data sheets, therefore it is determined from the total and volumetric efficiencies by assuming that the hydraulic efficiency is negligibly small

$$\eta_{mech} = \eta_{total} / \eta_V$$

The block positive direction is from port T to port P. This means that the pump transfers fluid from T to P provided that the shaft S rotates in the positive direction. The pressure differential across the pump is determined as $p = p_P - p_T$.

Basic Assumptions and Limitations

- Fluid compressibility is neglected.
- No loading on the pump shaft, such as inertia, friction, spring, and so on, is considered.
- Leakage inside the pump is assumed to be linearly proportional to its pressure differential.

Dialog Box and Parameters

Block Parameters: Variable-Displacement Pressure-Compensated Pump

Variable-Displacement Pressure-Compensated Pump

This block represents a variable-displacement, pressure-compensated hydraulic pump of any type as a data sheet-based model. The key parameters required to parameterize the block are the pump maximum displacement, volumetric and total efficiencies, regulation range, nominal pressure, and angular velocity.

Connections P and T are hydraulic conserving ports associated with the pump outlet and inlet, respectively. Connection S is a mechanical rotational conserving port associated with the pump driving shaft. The block positive direction is from port T to port P. This means that the pump delivers flow to port P as its driving shaft rotates in the globally assigned positive direction.

Settings

Parameters

Maximum displacement:	5e-6	m ³ /rad
Setting pressure:	100e5	Pa
Pressure regulation range:	6e5	Pa
Volumetric efficiency:	0.85	
Total efficiency:	0.75	
Nominal pressure:	100e5	Pa
Nominal angular velocity:	188	rad/s
Nominal kinematic viscosity:	18	cSt
Nominal fluid density:	950	kg/m ³

OK Cancel Help Apply

Maximum displacement

Pump displacement. The default value is $5e-6 \text{ m}^3/\text{rad}$.

Setting pressure

Pump pressure setting. The default value is $1e7 \text{ Pa}$.

Pressure regulation range

Pressure range required to change the pump displacement from its maximum to zero. The default value is $6e5 \text{ Pa}$.

Volumetric efficiency

Pump volumetric efficiency specified at nominal pressure, angular velocity, and fluid viscosity. The default value is 0.85 .

Total efficiency

Pump total efficiency, which is determined as a ratio between the hydraulic power at the pump outlet and mechanical power at the driving shaft at nominal pressure, angular velocity, and fluid viscosity. The default value is 0.75 .

Nominal pressure

Pressure differential across the pump, at which both the volumetric and total efficiencies are specified. The default value is $1e7 \text{ Pa}$.

Nominal angular velocity

Angular velocity of the driving shaft, at which both the volumetric and total efficiencies are specified. The default value is 188 rad/s .

Nominal kinematic viscosity

Working fluid kinematic viscosity, at which both the volumetric and total efficiencies are specified. The default value is 18 cSt.

Nominal fluid density

Working fluid density, at which both the volumetric and total efficiencies are specified. The default value is 900 kg/m³.

Global Parameters

Parameter determined by the type of working fluid:

- **Fluid kinematic viscosity**

Use the Hydraulic Fluid block or the Custom Hydraulic Fluid block to specify the fluid properties.

Ports

The block has the following ports:

T

Hydraulic conserving port associated with the pump suction, or inlet.

P

Hydraulic conserving port associated with the pump outlet.

S

Mechanical rotational conserving port associated with the pump driving shaft.

Examples

The “Closed-Loop Actuator with Variable-Displacement Pressure-Compensated Pump” example illustrates the use of the Variable-Displacement Pressure-Compensated Pump block in hydraulic systems.

Extended Capabilities**C/C++ Code Generation**

Generate C and C++ code using Simulink® Coder™.

See Also

Centrifugal Pump | Fixed-Displacement Pump | Variable-Displacement Pump

Topics

“Upgrading Simscape Fluids Models Containing Hydraulics (Isothermal) Blocks”

Introduced in R2006a

Variable-Displacement Pump

Variable-displacement bidirectional hydraulic pump

Library: Simscape / Fluids / Hydraulics (Isothermal) / Pumps and Motors



Description

The Variable-Displacement Pump block represents a device that extracts power from a mechanical rotational network and delivers it to a hydraulic (isothermal liquid) network. The pump displacement varies in proportion to the physical signal specified at port C or D. The exact port used depends on the block variant selected. See “Ports” on page 1-1746.

Ports **T** and **P** represent the pump inlets. Port **S** represents the pump drive shaft. During normal operation, the pressure gain from port **T** to port **P** is positive if the angular velocity at port **S** is positive also. This operation mode is referred to here as *forward pump*.

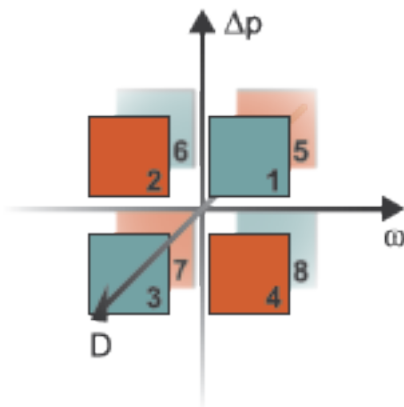

Operation Modes

A total of four operation modes are possible. The working mode depends on the pressure gain from port **T** to port **P** (Δp), the angular velocity at port **S** (ω), and on the instantaneous displacement of the component (D). The “Operation Modes” on page 1-1739 figure maps the modes to the octants of a Δp - ω - D chart. The modes are labeled 1-4:

- Mode **1**: forward pump — A positive shaft angular velocity generates a positive pressure gain.
- Mode **2**: reverse motor — A negative pressure drop (shown in the figure as a positive pressure gain) generates a negative shaft angular velocity.
- Mode **3**: reverse pump — A negative shaft angular velocity generates a negative pressure gain.

- **Mode 4:** forward motor — A positive pressure drop (shown in the figure as a negative pressure gain) generates a positive shaft angular velocity.

The response time of the pump is considered negligible in comparison with the system response time. The pump is assumed to reach steady state nearly instantaneously and is treated as a quasi-steady component.

Block Variants and Loss Parameterizations

The pump model accounts for power losses due to leakage and friction. Leakage is internal and occurs between the pump inlet and outlet only. The block computes the leakage flow rate and friction torque using your choice of five loss parameterizations. You select a parameterization using block variants and, in the **Analytical or tabulated data** case, the **Friction and leakage parameterization** parameter.

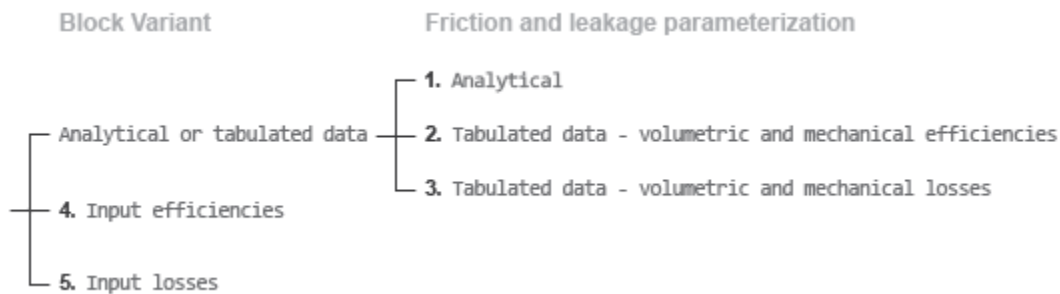

Loss Parameterizations

The block provides three Simulink variants to select from. To change the active block variant, right-click the block and select **Simscape > Block choices**. The available variants are:

- **Analytical or tabulated data** — Obtain the mechanical and volumetric efficiencies or losses from analytical models based on nominal parameters or from tabulated data. Use the **Friction and leakage parameterization** parameter to select the exact input type.
- **Input efficiencies** — Provide the mechanical and volumetric efficiencies directly through physical signal input ports.
- **Input losses** — Provide the mechanical and volumetric losses directly through physical signal input ports. The mechanical loss is defined as the internal friction torque. The volumetric loss is defined as the internal leakage flow rate.

Displacement Parameterizations

The displacement volume input depends on the block variant selected. If the active block variant is **Input efficiencies** or **Input losses**, the block obtains the instantaneous displacement volume directly from the physical signal input at port D.

If the active block variant is **Analytical or tabulated data**, the block computes the instantaneous displacement volume from the control member position specified at port C. This computation depends on the **Displacement parameterization** parameter setting:

- **Maximum displacement and control member stroke** — Compute the displacement volume per unit rotation as a linear function of the control member position specified at port C.

- **Displacement vs. control member position table** — Compute the displacement volume per unit volume using interpolation or extrapolation of displacement tabular data specified at discrete control member positions.

Flow Rate and Driving Torque

The volumetric flow rate generated at the pump is

$$q = q_{\text{Ideal}} + q_{\text{Leak}}$$

where:

- q is the net volumetric flow rate.
- q_{Ideal} is the ideal volumetric flow rate.
- q_{Leak} is the internal leakage volumetric flow rate.

The driving torque required to power the pump is

$$\tau = \tau_{\text{Ideal}} + \tau_{\text{Friction}}$$

where:

- τ is the net driving torque.
- τ_{Ideal} is the ideal driving torque.
- τ_{Friction} is the friction torque.

Ideal Flow Rate and Ideal Torque

The ideal volumetric flow rate is

$$q_{\text{Ideal}} = D_{\text{Sat}} \cdot \omega,$$

and the ideal driving torque is

$$\tau_{\text{Ideal}} = D_{\text{Sat}} \cdot \Delta p,$$

where:

- D_{Sat} is a smoothed displacement computed so as to remove numerical discontinuities between negative and positive displacements.
- ω is the instantaneous angular velocity of the rotary shaft.
- Δp is the instantaneous pressure gain from inlet to outlet.

Saturation Displacement

The saturation displacement depends on the block variant selected. If the active variant is Analytical or tabulated data,

$$D_{\text{Sat}} = \begin{cases} \text{sign}(D) \cdot D_{\text{Max}}, & |D| \geq D_{\text{Max}} \\ \sqrt{D^2 + D_{\text{Threshold}}^2}, & D \geq 0 \\ -\sqrt{D^2 + D_{\text{Threshold}}^2}, & D < 0 \end{cases},$$

where:

- D is the instantaneous fluid displacement determined from the physical signal input specified at port **C** or port **D**.
- D_{Max} is the specified value of the **Maximum displacement** block parameter.
- $D_{Threshold}$ is the specified value of the **Displacement threshold for pump-motor transition** block parameter.

If the active variant is `Input efficiencies` or `Input losses`, there is no upper bound on the displacement input and the saturation displacement reduces to:

$$D_{Sat} = \begin{cases} \sqrt{D^2 + D_{Thresh}^2}, & D \geq 0 \\ -\sqrt{D^2 + D_{Thresh}^2}, & D < 0 \end{cases}$$

Leakage Flow Rate and Friction Torque

The internal leakage flow rate and friction torque calculations depend on the block variant selected. If the block variant is `Analytical` or `tabulated data`, the calculations depend also on the **Leakage and friction parameterization** parameter setting. There are five possible permutations of block variant and parameterization settings.

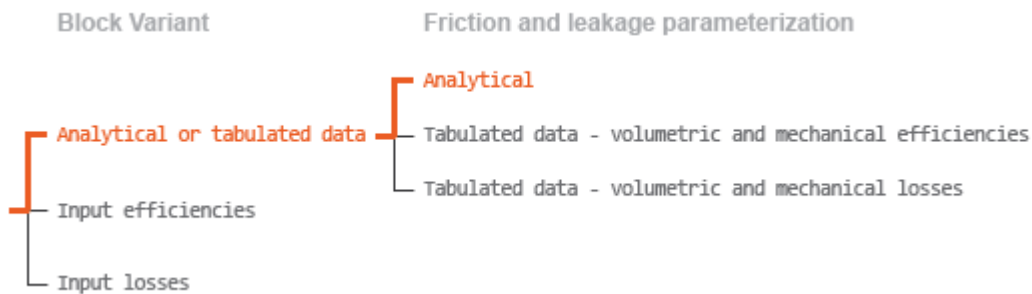

Case 1: Analytical Efficiency Calculation

If the active block variant is `Analytical` or `tabulated data` and the **Leakage and friction parameterization** parameter is set to `Analytical`, the leakage flow rate is

$$q_{Leak} = K_{HP}\Delta p,$$

and the friction torque is

$$\tau_{Friction} = \left(\tau_0 + K_{TP} \left| \frac{D_{Sat}}{D_{Max}} \right| |\Delta p| \right) \tanh\left(\frac{4\omega}{\omega_{Threshold}} \right),$$

where:

- K_{HP} is the Hagen-Poiseuille coefficient for laminar pipe flows. This coefficient is computed from the specified nominal parameters.
- K_{TP} is the specified value of the **Friction torque vs pressure gain coefficient** block parameter.
- τ_0 is the specified value of the **No-load torque** block parameter.
- $\omega_{Threshold}$ is the threshold angular velocity for the motor-pump transition. The threshold angular velocity is an internally set fraction of the specified value of the **Nominal shaft angular velocity** block parameter.

The Hagen-Poiseuille coefficient is determined from nominal fluid and component parameters through the equation

$$K_{HP} = \frac{\nu_{Nom}}{\rho v} \frac{\rho_{Nom} \omega_{Nom} D_{Max}}{\Delta p_{Nom}} (1 - \eta_{v,Nom}),$$

where:

- ν_{Nom} is the specified value of the **Nominal kinematic viscosity** block parameter. This is the kinematic viscosity at which the nominal volumetric efficiency is specified.
- ρ_{Nom} is the specified value of the **Nominal fluid density** block parameter. This is the density at which the nominal volumetric efficiency is specified.
- ω_{Nom} is the specified value of the **Nominal shaft angular velocity** block parameter. This is the angular velocity at which the nominal volumetric efficiency is specified.
- ρ is the actual fluid density in the attached hydraulic (isothermal liquid) network. This density can differ from the specified value of the **Nominal fluid density** block parameter.
- v is the kinematic viscosity of the fluid associated with the fluid network.
- Δp_{Nom} is the specified value of the **Nominal pressure gain** block parameter. This is the pressure drop at which the nominal volumetric efficiency is specified.
- $\eta_{v,Nom}$ is the specified value of the **Volumetric efficiency at nominal conditions** block parameter. This is the volumetric efficiency corresponding to the specified nominal conditions.

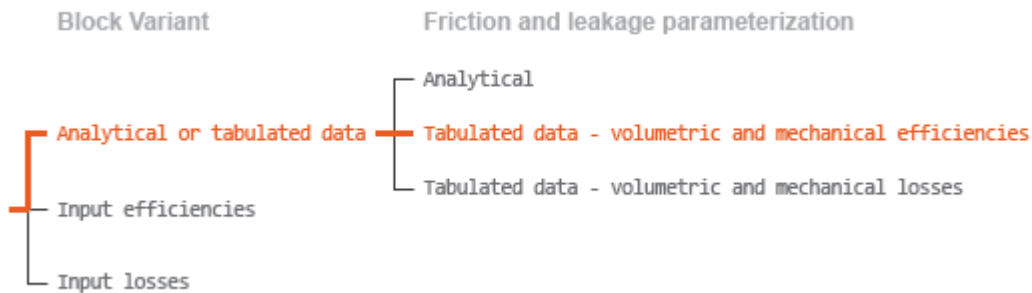

Case 2: Efficiency Tabulated Data

If the active block variant is Analytical or tabulated data and the **Leakage and friction parameterization** parameter is set to Tabulated data – volumetric and mechanical efficiencies, the leakage flow rate is

$$q_{Leak} = q_{Leak,Pump} \frac{(1 + \alpha)}{2} + q_{Leak,Motor} \frac{(1 - \alpha)}{2},$$

and the friction torque is

$$\tau_{Friction} = \tau_{Friction,Pump} \frac{1 + \alpha}{2} + \tau_{Friction,Motor} \frac{1 - \alpha}{2},$$

where:

- α is a numerical smoothing parameter for the motor-pump transition.
- $q_{Leak,Pump}$ is the leakage flow rate in pump mode.

- $q_{\text{Leak, Motor}}$ is the leakage flow rate in motor mode.
- $\tau_{\text{Friction, Pump}}$ is the friction torque in pump mode.
- $\tau_{\text{Friction, Motor}}$ is the friction torque in motor mode.

The smoothing parameter α is given by the hyperbolic function

$$\alpha = \tanh\left(\frac{4\Delta p}{\Delta p_{\text{Threshold}}}\right) \cdot \tanh\left(\frac{4\omega}{\omega_{\text{Threshold}}}\right) \cdot \tanh\left(\frac{4D}{D_{\text{Threshold}}}\right),$$

where:

- $\Delta p_{\text{Threshold}}$ is the specified value of the **Pressure drop threshold for motor-pump transition** block parameter.
- $\omega_{\text{Threshold}}$ is the specified value of the **Angular velocity threshold for motor-pump transition** block parameter.
- $D_{\text{Threshold}}$ is the specified value of the **Displacement threshold for motor-pump transition** block parameter.

The leakage flow rate is computed from efficiency tabulated data through the equation

$$q_{\text{Leak, Pump}} = (1 - \eta_v)q_{\text{Ideal}},$$

in pump mode and through the equation

$$q_{\text{Leak, Motor}} = -(1 - \eta_v)q,$$

in motor mode, where:

- η_v is the volumetric efficiency obtained through interpolation or extrapolation of the **Volumetric efficiency table, e_v(dp,w,D)** parameter data.

Similarly, the friction torque is computed from efficiency tabulated data through the equation

$$\tau_{\text{Friction, Pump}} = (1 - \eta_m)\tau,$$

in pump mode and through the equation

$$\tau_{\text{Friction, Motor}} = -(1 - \eta_m)\tau_{\text{Ideal}},$$

in motor mode, where:

- η_m is the mechanical efficiency obtained through interpolation or extrapolation of the **Mechanical efficiency table, e_m(dp,w,D)** parameter data.

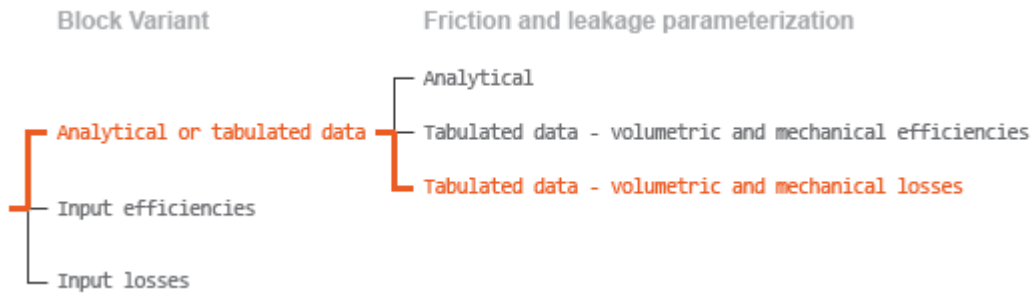

Case 3: Loss Tabulated Data

If the active block variant is Analytical or tabulated data and the **Leakage and friction parameterization** parameter is set to Tabulated data – volumetric and mechanical losses, the leakage flow rate equation is

$$q_{\text{Leak}} = q_{\text{Leak}}(\Delta p, \omega, D_{\text{Sat}}).$$

and the friction torque equation is

$$\tau_{\text{Friction}} = \tau_{\text{Friction}}(\Delta p, \omega, D_{\text{Sat}}),$$

where $q_{\text{Leak}}(\Delta p, \omega, D_{\text{Sat}})$ and $\tau_{\text{Friction}}(\Delta p, \omega, D_{\text{Sat}})$ are the volumetric and mechanical losses, obtained through interpolation or extrapolation of the **Volumetric loss table, $q_{\text{loss}}(\text{dp}, \omega, \text{D})$** and **Mechanical loss table, torque_loss (dp, ω , D)** parameter data.

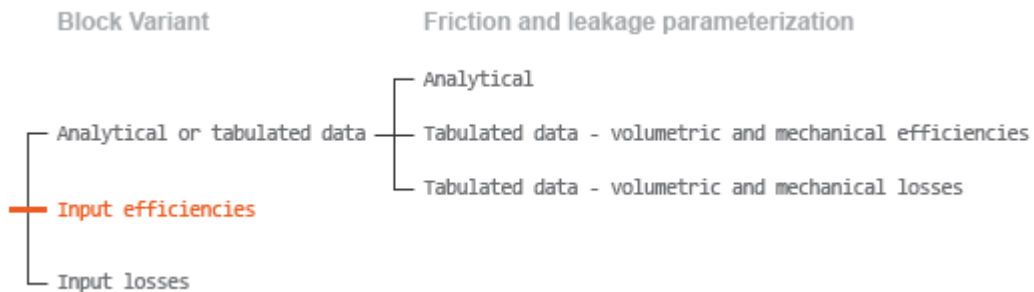

Case 4: Efficiency Physical Signal Inputs

If the active block variant is Input efficiencies, the leakage flow rate and friction torque calculations are as described for efficiency tabulated data (case 2). The volumetric and mechanical efficiency lookup tables are replaced with physical signal inputs that you specify through ports EV and EM.

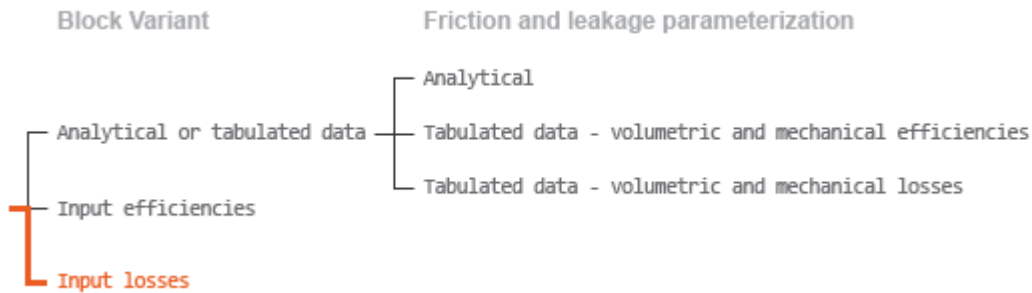

Case 5: Loss Physical Signal Inputs

If the block variant is `Input losses`, the leakage flow rate and friction torque calculations are as described for loss tabulated data (case 3). The volumetric and mechanical loss lookup tables are replaced with physical signal inputs that you specify through ports `LV` and `LM`.

Assumptions

- Fluid compressibility is negligible.
- Loading on the pump shaft due to inertia, friction, and spring forces is negligible.

Ports

Input

C – Control member offset, m

physical signal

Physical signal input port for the control member position. The block maps the control member offset to the corresponding displacement volume using the tabulated data specified in the block dialog box.

Dependencies

This port is exposed only when the block variant is set to `Analytical` or `tabulated data`.

D – Displacement volume, cm³/rev

physical signal

Physical signal input port for the volume of fluid displaced per unit rotation. A smoothing function eases the transition between positive and negative input values.

Dependencies

This port is exposed only when the block variant is set to `Input efficiencies` or `Input losses`.

EV – Volumetric efficiency, unitless

physical signal

Physical signal input port for the volumetric efficiency coefficient. The input signal has an upper bound at the **Maximum volumetric efficiency** parameter value and a lower bound at the **Minimum volumetric efficiency** parameter value.

Dependencies

This port is exposed only when the block variant is set to Input efficiencies.

EM — Mechanical efficiency, unitless

physical signal

Physical signal input port for the mechanical efficiency coefficient. The input signal has an upper bound at the **Maximum mechanical efficiency** parameter value and a lower bound at the **Minimum mechanical efficiency** parameter value.

Dependencies

This port is exposed only when the block variant is set to Input efficiencies.

LV — Volumetric loss, m³/s

physical signal

Physical signal input port for the volumetric loss, defined as the internal leakage flow rate between the pump inlets.

Dependencies

This port is exposed only when the block variant is set to Input losses.

LM — Mechanical loss, N*m

physical signal

Physical signal input port for the mechanical loss, defined as the friction torque on the rotating pump shaft.

Dependencies

This port is exposed only when the block variant is set to Input losses.

Conserving**T — Pump inlet**

hydraulic (isothermal liquid)

Hydraulic (isothermal liquid) conserving port representing the pump inlet.

P — Pump outlet

hydraulic (isothermal liquid)

Hydraulic (isothermal liquid) conserving port representing the pump outlet.

S — Pump shaft

mechanical rotational

Mechanical rotational conserving port representing the pump shaft.

Parameters

The exposed block parameters depend on the active block variant. See “Block Variants and Loss Parameterizations” on page 1-1740.

Variant 1: Analytical or tabulated data**Displacement parameterization — Parameterization used to map control positions to displacements**

Maximum displacement and control member stroke (default)

Parameterization used to convert the physical signal at input port C to an instantaneous displacement:

- **Maximum displacement and control member stroke** — Compute the displacement as a linear function of the control position specified at port C.
- **Displacement vs. control member position table** — Obtain the displacement through interpolation or extrapolation of tabulated data specified over a range of control positions.

Dependencies

This parameter is enabled when the block variant is set to **Analytical** or **tabulated data**.

Restricted Parameter

This parameter is locked for editing when using the Simscape Restricted mode.

Maximum stroke — Control position corresponding to maximum displacement

0.005 m (default) | scalar with units of length

Control position corresponding to a maximum displacement. The physical signal input at port C saturates at this value. If the input rises higher, the block sets the control position to the maximum stroke.

Dependencies

This parameter is enabled when the block variant is set to **Analytical** or **tabulated data**.

Maximum displacement — Maximum fluid volume swept per unit shaft rotation30 cm³/rev (default) | scalar with units of volume/angle

Maximum fluid volume swept per unit shaft rotation. The displacement reaches this value when the control position hits the maximum stroke.

Dependencies

This parameter is enabled when the block variant is set to **Analytical** or **tabulated data** and the **Displacement parameterization** parameter is set to **Maximum displacement and control member stroke**.

Control member position vector — Control positions at which to specify displacement tabular data[-0.0075, -0.0025, 0.0, 0.0025, 0.0075] m (default) | *M*-element vector with units of length

M-element vector of control positions at which to specify the instantaneous displacement. The vector size, *M*, must be two or greater. The vector elements need not be uniformly spaced. However, they must be monotonically increasing or decreasing.

Dependencies

This parameter is enabled when the block variant is set to `Analytical` or `tabulated data` and the **Displacement parameterization** parameter is set to `Displacement vs. control member position table`.

Displacement vector — Displacement tabular data for the specified control positions

`[-30.0, -19.0, 0.0, 19.0, 30.0]` cm^3/rev (default) | *M*-element vector with units of volume/angle

M-element vector with the displacement tabular data for the specified control positions. The vector size, *M*, must match that of the **Control member position vector** parameter.

Dependencies

This parameter is enabled when the block variant is set to `Analytical` or `tabulated data` and the **Displacement parameterization** parameter is set to `Displacement vs. control member position table`.

Interpolation method — Numerical technique used to determine displacements within the tabular data range

`Linear` (default) | `Smooth`

Numerical technique used to map control position signals to displacements within the tabular data range. The interpolation method joins tabular data points using straight or curved line segments. Displacements within the range of the tabular data are assumed to lie on these segments.

- **Linear** — Join neighboring data points using straight line segments. Line slopes are generally discontinuous at the line segment end points.
- **Smooth** — Join neighboring data points using curved line segments generated with a modified Akima algorithm. Line slopes are continuous at the line segment end points.

Dependencies

This parameter is enabled when the block variant is set to `Analytical` or `tabulated data` and the **Displacement parameterization** parameter is set to `Displacement vs. control member position table`.

Restricted Parameter

This parameter is locked for editing when using the Simscape Restricted mode.

Extrapolation method — Numerical technique used to determine displacements outside the tabular data range

`Linear` (default) | `Nearest`

Numerical technique used to map control position signals to displacements outside the tabular data range. The extrapolation method extends the first and last tabular data points outward using horizontal or sloped straight line segments. Displacements outside the range of the tabular data are assumed to lie on these segments.

- **Linear** — Extend the tabular data using sloped straight line segments. The line slopes are computed from the first and last two tabular data points.
- **Nearest** — Extend the tabular data using horizontal straight line segments. The lines correspond to the displacements specified in the first and last tabular data points.

Dependencies

This parameter is enabled when the block variant is set to `Analytical` or `tabulated data` and the **Displacement parameterization** parameter is set to `Displacement vs. control member position table`.

Restricted Parameter

This parameter is locked for editing when using the Simscape Restricted mode.

Leakage and friction parameterization – Parameterization used to compute leakage flow rate and friction torque

`Analytical` (default)

Parameterization used to compute flow-rate and torque losses due to internal leaks and friction. The `Analytical` parameterization relies on nominal parameters generally available from component data sheets. The remaining, tabular, options rely on lookup tables to map pressure drop, angular velocity, and displacement to component efficiencies or losses. The tabular options include:

- `Tabulated data – volumetric and mechanical efficiencies`
- `Tabulated data – volumetric and mechanical losses`

Dependencies

This parameter is enabled when the block variant is set to `Analytical` or `tabulated data`.

Nominal shaft angular velocity – Shaft angular velocity at which to specify the volumetric efficiency

`188 rad/s` (default) | scalar with units of angle/time

Angular velocity of the rotating shaft at which the component's nominal volumetric efficiency is known. Nominal parameters are typically published for standard operating conditions in manufacturer's data sheets. The block uses this parameter to calculate, using simple linear functions, the leakage flow rate and friction torque.

Dependencies

This parameter is enabled when the block variant is set to `Analytical` or `tabulated data` and the **Leakage and friction parameterization** parameter is set to `Analytical`.

Nominal pressure gain – Pressure gain at which to specify the volumetric efficiency

`100e5 Pa` (default)

Pressure gain from inlet to outlet at which the component's nominal volumetric efficiency is known. Nominal parameters are typically published for standard operating conditions in manufacturer's data sheets. The block uses this parameter to calculate, using a simple linear function, the internal leakage flow rate.

Dependencies

This parameter is enabled when the block variant is set to `Analytical` or `tabulated data` and the **Leakage and friction parameterization** parameter is set to `Analytical`.

Nominal kinematic viscosity – Kinematic viscosity at which to specify the volumetric efficiency

`18 cSt` (default) | scalar with units of area/time

Kinematic viscosity of the hydraulic fluid at which the component's nominal volumetric efficiency is known. Nominal parameters are typically published for standard operating conditions in manufacturer's data sheets. The block uses this parameter to calculate, using a simple linear function, the internal leakage flow rate.

Dependencies

This parameter is enabled when the block variant is set to **Analytical** or **tabulated data** and the **Leakage and friction parameterization** parameter is set to **Analytical**.

Nominal fluid density – Fluid density at which to specify the volumetric efficiency

900 kg/m³ (default) | scalar with units of mass/volume

Mass density of the hydraulic fluid at which the component's nominal volumetric efficiency is known. Nominal parameters are typically published for standard operating conditions in manufacturer's data sheets. The block uses this parameter to calculate, using a simple linear function, the internal leakage flow rate.

Dependencies

This parameter is enabled when the block variant is set to **Analytical** or **tabulated data** and the **Leakage and friction parameterization** parameter is set to **Analytical**.

Volumetric efficiency at nominal conditions – Volumetric efficiency at the specified nominal conditions

0.92 (default) | unitless scalar between 0 and 1

Volumetric efficiency, defined as the ratio of actual to ideal volumetric flow rates, at the specified nominal conditions. Nominal parameters are typically published for standard operating conditions in manufacturer's data sheets. The block uses this parameter to calculate, using a simple linear function, the internal leakage flow rate.

Dependencies

This parameter is enabled when the block variant is set to **Analytical** or **tabulated data** and the **Leakage and friction parameterization** parameter is set to **Analytical**.

No-load torque – Minimum torque required to induce shaft rotation

0.05 N*m (default) | scalar with units of torque

Torque required to overcome seal friction and induce rotation of the mechanical shaft. This torque is the load-independent component of the total friction torque.

Dependencies

This parameter is enabled when the block variant is set to **Analytical** or **tabulated data** and the **Leakage and friction parameterization** parameter is set to **Analytical**.

Friction torque vs. pressure gain coefficient at maximum displacement – Proportionality constant at maximum displacement between friction torque and pressure gain

0.6e-6 N*m/Pa (default) | scalar with units of torque/pressure

Proportionality constant at maximum displacement between the friction torque on the mechanical shaft and the pressure gain from inlet to outlet.

Dependencies

This parameter is enabled when the block variant is set to Analytical or tabulated data and the **Leakage and friction parameterization** parameter is set to Tabulated data – volumetric and mechanical efficiencies.

Displacement threshold for pump–motor transition – Displacement at which to initiate the transition between pumping and motoring modes

0.5 cm³/rev (default) | scalar with units of volume/angle

Absolute value of the instantaneous displacement below which the component transitions between pumping and motoring modes. A hyperbolic Tanh function transforms the leakage flow rate and friction torque such that the transition is continuous and smooth.

Check if lower side pressure violating minimum valid condition – Simulation warning mode for minimum valid pressure

None (default) | Warning

Simulation warning mode for invalid pressures at the component ports. Select Warning to be notified when pressure falls below a minimum specified value. The warning can be useful in models where pressure can fall below the saturated vapor pressure of the hydraulic fluid, causing cavitation to occur.

Minimum valid pressure – Pressure required to trigger simulation warning

0 (default) | scalar with units of pressure

Lower bound of the pressure validity range. A warning is issued if pressure falls below the specified value.

Dependencies

This parameter is enabled when the **Check if lower side pressure violating minimum valid condition** parameter is set to Warning.

Pressure gain vector for efficiencies, dp – Pressure gains at which to specify the volumetric and mechanical efficiencies

M -element vector with units of pressure (default)

M -element vector of pressure gains at which to specify the efficiency tabular data. The vector size, M , must be two or greater. The vector elements need not be uniformly spaced. However, they must monotonically increase in value from left to right.

Dependencies

This parameter is enabled when the block variant is set to Analytical or tabulated data and the **Leakage and friction parameterization** parameter is set to Tabulated data – volumetric and mechanical efficiencies.

Shaft angular velocity vector for efficiencies, w – Angular velocities at which to specify the volumetric and mechanical efficiencies

N -element vector with units of angular velocity (default)

N -element vector of shaft angular velocities at which to specify the efficiency tabular data. The vector size, N , must be two or greater. The vector elements need not be uniformly spaced. However, they must monotonically increase in value from left to right.

Dependencies

This parameter is enabled when the block variant is set to Analytical or tabulated data and the **Leakage and friction parameterization** parameter is set to Tabulated data – volumetric and mechanical efficiencies.

Displacement vector for efficiencies, D – Displacements at which to specify the volumetric and mechanical efficiencies

L -element vector with units of volume/angle (default)

L -element vector of displacements at which to specify the efficiency tabular data. The vector size, N , must be two or greater. The vector elements need not be uniformly spaced. However, they must be monotonically increasing or decreasing.

Volumetric efficiency table, $e_v(dp,w,D)$ – Volumetric efficiencies at the specified pressure gains, angular velocities, and displacements

unitless M -by- N -by- L matrix

M -by- N -by- L matrix with the volumetric efficiencies at the specified fluid pressure gains, shaft angular velocities, and displacements. The efficiencies must fall in the range of 0-1. M , N , and L are the sizes of the specified lookup-table vectors:

- M is the number of vector elements in the **Pressure gain vector for efficiencies, dp** parameter.
- N is the number of vector elements in the **Shaft angular velocity vector for efficiencies, w** parameter.
- L is the number of vector elements in the **Displacement vector for efficiencies, D** parameter.

Dependencies

This parameter is enabled when the block variant is set to Analytical or tabulated data and the **Leakage and friction parameterization** parameter is set to Tabulated data – volumetric and mechanical efficiencies.

Mechanical efficiency table, $e_m(dp,w,D)$ – Mechanical efficiencies at the specified pressure drops, angular velocities, and displacements

unitless M -by- N matrix

M -by- N -by- L matrix with the mechanical efficiencies corresponding to the specified fluid pressure gains, shaft angular velocities, and displacements. The efficiencies must fall in the range of 0-1. M , N , and L are the sizes of the specified lookup-table vectors:

- M is the number of vector elements in the **Pressure gain vector for efficiencies, dp** parameter.
- N is the number of vector elements in the **Shaft angular velocity vector for efficiencies, w** parameter.
- L is the number of vector elements in the **Displacement vector for efficiencies, D** parameter.

Dependencies

This parameter is enabled when the block variant is set to Analytical or tabulated data and the **Leakage and friction parameterization** parameter is set to Tabulated data – volumetric and mechanical efficiencies.

Pressure gain threshold for pump–motor transition – Pressure gain at which to initiate a smooth transition between motor and pump modes

1e5 Pa (default) | scalar with units of pressure

Pressure gain from inlet to outlet below which the component begins to transition between motoring and pumping modes. A hyperbolic Tanh function transforms the leakage flow rate and friction torque such that the transition is continuous and smooth.

Dependencies

This parameter is enabled when the block variant is set to `Input efficiencies` or when the block variant is set to `Analytical` or `tabulated data` and the **Leakage and friction parameterization** parameter is set to `Tabulated data – volumetric and mechanical efficiencies`.

Angular velocity threshold for pump–motor transition – Shaft angular velocity at which to initiate a smooth transition between pump and motor modes

10 rad/s (default) | scalar with units of angle/time

Shaft angular velocity below which the component begins to transition between motoring and pumping modes. A hyperbolic Tanh function transforms the leakage flow rate and friction torque such that the transition is continuous and smooth.

Dependencies

This parameter is enabled when the block variant is set to `Input efficiencies` or when the block variant is set to `Analytical` or `tabulated data` and the **Leakage and friction parameterization** parameter is set to `Tabulated data – volumetric and mechanical efficiencies`.

Check if operating beyond the octants of supplied tabulated data – Simulation warning mode for operating conditions outside the range of tabulated data

None (default) | `Warning`

Simulation warning mode for operating conditions outside the range of tabulated data. Select `Warning` to be notified when the fluid pressure gain, shaft angular velocity, or instantaneous displacement cross outside the specified tabular data. The warning does not cause simulation to stop.

Dependencies

This parameter is enabled when the block variant is set to `Analytical` or `tabulated data` and the **Leakage and friction parameterization** parameter is set to `Tabulated data – volumetric and mechanical efficiencies` or `Tabulated data – volumetric and mechanical losses`.

Pressure gain vector for losses, dp – Pressure gains at which to specify the volumetric and mechanical losses

M -element vector with units of pressure (default)

M -element vector of pressure gains at which to specify the loss tabular data. The vector size, M , must be two or greater. The vector elements need not be uniformly spaced. However, they must monotonically increase in value from left to right.

Dependencies

This parameter is enabled when the block variant is set to Analytical or tabulated data and the **Leakage and friction parameterization** parameter is set to Tabulated data – volumetric and mechanical losses.

Shaft angular velocity vector for losses, w – Angular velocities at which to specify the volumetric and mechanical losses

N-element vector with units of angle/time (default)

N-element vector of shaft angular velocities at which to specify the efficiency tabular data. The vector size, *N*, must be two or greater. The vector elements need not be uniformly spaced. However, they must monotonically increase in value from left to right.

Dependencies

This parameter is enabled when the block variant is set to Analytical or tabulated data and the **Leakage and friction parameterization** parameter is set to Tabulated data – volumetric and mechanical losses.

Displacement vector for losses, D – Displacements at which to specify the volumetric and mechanical losses

L-element vector with units of volume/angle (default)

L-element vector of displacements at which to specify the loss tabular data. The vector size, *N*, must be two or greater. The vector elements need not be uniformly spaced. However, they must be monotonically increasing or decreasing.

Volumetric loss table, $q_{\text{loss}}(dp, w, D)$ – Internal leakage flow rates at the specified pressure gains, angular velocities, and displacements

M-by-*N*-by-*L* matrix with units of volume/time

M-by-*N*-by-*L* matrix with the volumetric gains at the specified fluid pressure drops, shaft angular velocities, and displacements. Volumetric loss is defined here as the internal leakage volumetric flow rate between port A and port B. *M*, *N*, and *L* are the sizes of the specified lookup-table vectors:

- *M* is the number of vector elements in the **Pressure gain vector for losses, dp** parameter.
- *N* is the number of vector elements in the **Shaft angular velocity vector for losses, w** parameter.
- *L* is the number of vector elements in the **Displacement vector for losses, D** parameter.

Dependencies

This parameter is enabled when the block variant is set to Analytical or tabulated data and the **Leakage and friction parameterization** parameter is set to Tabulated data – volumetric and mechanical losses.

Mechanical loss table, $\text{torque}_{\text{loss}}(dp, w, D)$ – Friction torques at the specified pressure gains, angular velocities, and displacements

M-by-*N*-by-*L* matrix with units of torque

M-by-*N*-by-*L* matrix with the mechanical losses at the specified fluid pressure gains, shaft angular velocities, and displacements. Mechanical loss is defined here as the friction torque due to seals and internal components. *M*, *N*, and *L* are the sizes of the specified lookup-table vectors:

- M is the number of vector elements in the **Pressure gain vector for losses, dp** parameter.
- N is the number of vector elements in the **Shaft angular velocity vector for losses, w** parameter.
- L is the number of vector elements in the **Displacement vector for losses, D** parameter.

Dependencies

This parameter is enabled when the block variant is set to Analytical or tabulated data and the **Leakage and friction parameterization** parameter is set to Tabulated data – volumetric and mechanical losses.

Variant 2: Input efficiencies

Pressure gain threshold for pump–motor transition – Pressure gain at which to initiate a smooth transition between motor and pump modes

1e5 Pa (default) | scalar with units of pressure

Pressure gain from inlet to outlet below which the component begins to transition between motoring and pumping modes. A hyperbolic Tanh function transforms the leakage flow rate and friction torque such that the transition is continuous and smooth.

Dependencies

This parameter is enabled when the block variant is set to Input efficiencies.

Angular velocity threshold for pump–motor transition – Angular velocity at which to initiate a smooth transition between pump and motor modes

10 rad/s (default) | scalar with units of angle/time

Shaft angular velocity below which the component begins to transition between motoring and pumping modes. A hyperbolic Tanh function transforms the leakage flow rate and friction torque such that the transition is continuous and smooth.

Dependencies

This parameter is enabled when the block variant is set to Input efficiencies.

Displacement threshold for motor-pump transition – Displacement at which to initiate a smooth transition between pump and motor modes

0.5 cm³/rev (default) | scalar with units of volume/angle

Absolute value of the instantaneous displacement below which the component transitions between motoring and pumping modes. A hyperbolic Tanh function transforms the leakage flow rate and friction torque such that the transition is continuous and smooth.

Minimum volumetric efficiency – Lower saturation bound on the volumetric efficiency input signal

1e-3 (default) | unitless scalar between 0 and 1

Smallest allowed value of the volumetric efficiency. The input from physical signal port EV saturates at the specified value. If the input signal falls below the minimum volumetric efficiency, the volumetric efficiency is set to the minimum volumetric efficiency.

Dependencies

This parameter is enabled when the block variant is set to Input efficiencies.

Maximum volumetric efficiency – Upper saturation bound on the volumetric efficiency input signal

1 (default) | unitless scalar between 0 and 1

Largest allowed value of the volumetric efficiency. The input from physical signal port EV saturates at the specified value. If the input signal rises above the maximum volumetric efficiency, the volumetric efficiency is set to the maximum volumetric efficiency.

Dependencies

This parameter is enabled when the block variant is set to Input efficiencies.

Minimum mechanical efficiency – Lower saturation bound on the volumetric efficiency input signal

1e-3 (default) | unitless scalar between 0 and 1

Smallest allowed value of the mechanical efficiency. The input from physical signal port EM saturates at the specified value. If the input signal falls below the minimum mechanical efficiency, the mechanical efficiency is set to the minimum mechanical efficiency.

Dependencies

This parameter is enabled when the block variant is set to Input efficiencies.

Maximum mechanical efficiency – Upper saturation bound on the volumetric efficiency input signal

1 (default) | unitless scalar between 0 and 1

Largest allowed value of the mechanical efficiency. The input from physical signal port EM saturates at the specified value. If the input signal rises above the maximum mechanical efficiency, the mechanical efficiency is set to the maximum mechanical efficiency.

Dependencies

This parameter is enabled when the block variant is set to Input efficiencies.

Check if lower side pressure violating minimum valid condition – Simulation warning mode for minimum valid pressure

None (default) | Warning

Simulation warning mode for invalid pressures at the component ports. Select Warning to be notified when pressure falls below a minimum specified value. The warning can be useful in models where pressure can fall below the saturated vapor pressure of the hydraulic fluid, causing cavitation to occur.

Minimum valid pressure – Pressure required to trigger simulation warning

0 (default) | scalar with units of pressure

Lower bound of the pressure validity range. A warning is issued if pressure falls below the specified value.

Dependencies

This parameter is enabled when the **Check if lower side pressure violating minimum valid condition** parameter is set to Warning.

Variant 3: Input losses

Displacement threshold for pump–motor transition — Displacement below which the transition between pumping and motoring modes begins

0.5 cm³/rev (default) | scalar with units of volume/angle

Absolute value of the instantaneous displacement below which the component transitions between pumping and motoring modes. A hyperbolic Tanh function transforms the leakage flow rate and friction torque such that the transition is continuous and smooth.

Check if operating beyond the pump mode — Simulation warning mode for operating conditions outside pumping mode

None (default) | Warning

Simulation warning mode for operating conditions outside the pumping mode. A warning is issued if the pump transitions to motoring mode. Select Warning to be notified when this transition occurs. The warning does not cause simulation to stop.

Dependencies

This parameter is enabled when the block variant is set to Input losses.

Check if lower side pressure violating minimum valid condition — Simulation warning mode for minimum valid pressure

None (default) | Warning

Simulation warning mode for invalid pressures at the component ports. Select Warning to be notified when pressure falls below a minimum specified value. The warning can be useful in models where pressure can fall below the saturated vapor pressure of the hydraulic fluid, causing cavitation to occur.

Minimum valid pressure — Pressure required to trigger simulation warning

0 (default) | scalar with units of pressure

Lower bound of the pressure validity range. A warning is issued if pressure falls below the specified value.

Dependencies

This parameter is enabled when the **Check if lower side pressure violating minimum valid condition** parameter is set to Warning.

Extended Capabilities

C/C++ Code Generation

Generate C and C++ code using Simulink® Coder™.

See Also

Fixed-Displacement Pump | Fixed-Displacement Pump (TL) | Fixed-Displacement Motor | Variable-Displacement Motor | Fixed-Displacement Motor (TL)

Topics

“Upgrading Simscape Fluids Models Containing Hydraulics (Isothermal) Blocks”

Variable-Displacement Pump (IL)

Variable-displacement pump in an isothermal liquid network

Library: Simscape / Fluids / Isothermal Liquid / Pumps & Motors

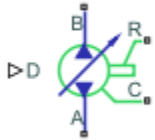

Description

The Variable-Displacement Pump (IL) block models a pump with variable-volume displacement. The fluid may move from port **A** to port **B**, called *forward mode*, or from port **B** to port **A**, called *reverse mode*. Pump mode operation occurs when there is a pressure gain in the direction of the flow. Motor mode operation occurs when there is a pressure drop in the direction of the flow.

The shaft rotation corresponds to the sign of the fluid volume moving through the pump, which is received as a physical signal at port **D**. Positive fluid displacement at **D** corresponds to positive shaft rotation in forward mode. Negative fluid displacement at **D** corresponds to negative shaft angular velocity in forward mode.

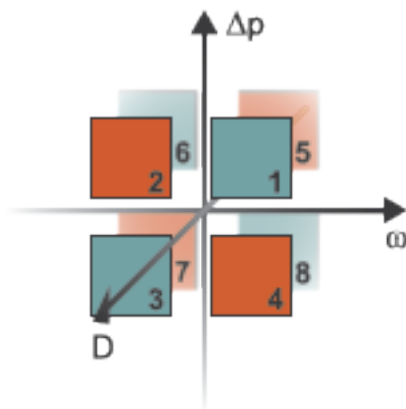

Operation Modes

The block has eight modes of operation. The working mode depends on the pressure gain from port **A** to port **B**, $\Delta p = p_B - p_A$; the angular velocity, $\omega = \omega_R - \omega_C$; and the fluid volumetric displacement at port **D**. The figure above maps these modes to the octants of a Δp - ω - D chart:

- Mode 1, *Forward Pump*: Positive shaft angular velocity causes a pressure increase from port **A** to port **B** and flow from port **A** to port **B**.
- Mode 2, *Reverse Motor*: Flow from port **B** to port **A** causes a pressure decrease from **B** to **A** and negative shaft angular velocity.

- Mode 3, *Reverse Pump*: Negative shaft angular velocity causes a pressure increase from port **B** to port **A** and flow from **B** to **A**.
- Mode 4, *Forward Motor*: Flow from port **A** to **B** causes a pressure decrease from **A** to **B** and positive shaft angular velocity.
- Mode 5, *Reverse Motor*: Flow from port **B** to port **A** causes a pressure decrease from **B** to **A** and positive shaft angular velocity.
- Mode 6, *Forward Pump*: Negative shaft angular velocity causes pressure increase from **A** to **B** and flow from **A** to **B**.
- Mode 7, *Forward Motor*: Flow from port **A** to **B** causes a pressure decrease from **A** to **B** and negative shaft angular velocity.
- Mode 8, *Reverse Pump*: Positive shaft angular velocity causes a pressure increase from port **B** to port **A** and flow from **B** to **A**.

The pump block has analytical, lookup table, and physical signal parameterizations. When using tabulated data or an input signal for parameterization, you can choose to characterize pump operation based on efficiency or losses.

The threshold parameters **Pressure gain threshold for pump-motor transition**, **Angular velocity threshold for pump-motor transition**, and **Displacement threshold for pump-motor transition** identify regions where numerically smoothed flow transition between the pump operational modes can occur. For the pressure and angular velocity thresholds, choose a transition region that provides some margin for the transition term, but which is small enough relative to the typical pump pressure gain and angular velocity so that it will not impact calculation results. For the displacement threshold, choose a threshold value that is smaller than the typical displacement volume during normal operation.

Analytical Leakage and Friction Parameterization

If you set **Leakage and friction parameterization** to `Analytical`, the block calculates internal leakage and shaft friction from constant nominal values of shaft velocity, pressure gain, volumetric displacement, and volumetric efficiency. The leakage flow rate, which is correlated with the pressure differential over the pump, is calculated as:

$$\dot{m}_{leak} = K\rho_{avg}\Delta p,$$

where:

- Δp is $p_B - p_A$.
- ρ_{avg} is the average fluid density.
- K is the Hagen-Poiseuille coefficient for analytical loss,

$$K = \frac{D_{nom}\omega_{nom}(1 - \eta_{v, nom})}{\Delta p_{nom}},$$

where:

- D_{nom} is the **Nominal displacement**.
- ω_{nom} is the **Nominal shaft angular velocity**.
- η_{nom} is the **Volumetric efficiency at nominal conditions**.
- Δp_{nom} is the **Nominal pressure gain**.

The friction torque, which is related to the pump pressure differential, is calculated as:

$$\tau_{fr} = \left(\tau_0 + k \left| \Delta p \frac{D}{D_{nom}} \right| \right) \tanh \left(\frac{4\omega}{5 \times 10^{-5} \omega_{nom}} \right),$$

where:

- τ_0 is the **No-load torque**.
- k is the friction torque vs. pressure gain coefficient at nominal displacement, which is determined from the **Mechanical efficiency at nominal conditions**, $\eta_{m,nom}$:

$$k = \frac{\tau_{fr,nom} - \tau_0}{\Delta p_{nom}}.$$

$\tau_{fr,nom}$ is the friction torque at nominal conditions:

$$\tau_{fr,nom} = \left(\frac{1 - \eta_{m,nom}}{\eta_{m,nom}} \right) D_{nom} \Delta p_{nom}.$$

- ω is the relative shaft angular velocity, or $\omega_R - \omega_C$.

Tabulated Data Parameterizations

When using tabulated data for pump efficiencies or losses, you can provide data for one or more of the pump operational modes. The signs of the tabulated data determine the operational regime of the block. When data is provided for less than eight operational modes, the block calculates the complementing data for the other mode(s) by extending the given data into the remaining octants.

The Tabulated data - volumetric and mechanical efficiencies parameterization

The leakage flow rate is calculated as:

$$\dot{m}_{leak} = \dot{m}_{leak,pump} \left(\frac{1 + \alpha}{2} \right) + \dot{m}_{leak,motor} \left(\frac{1 - \alpha}{2} \right),$$

where:

- $\dot{m}_{leak,pump} = (1 - \eta_v) \dot{m}_{ideal}$
- $\dot{m}_{leak,motor} = (\eta_v - 1) \dot{m}$

and η_v is the volumetric efficiency, which is interpolated from the user-provided tabulated data. The transition term, α , is

$$\alpha = \tanh \left(\frac{4\Delta p}{\Delta p_{threshold}} \right) \tanh \left(\frac{4\omega}{\omega_{threshold}} \right) \tanh \left(\frac{4D}{D_{threshold}} \right),$$

where:

- Δp is $p_B - p_A$.
- $\Delta p_{threshold}$ is the **Pressure gain threshold for pump-motor transition**.
- ω is $\omega_R - \omega_C$.
- $\omega_{threshold}$ is the **Angular velocity threshold for pump-motor transition**.

The friction torque is calculated as:

$$\tau_{fr} = \tau_{fr, pump} \left(\frac{1 + \alpha}{2} \right) + \tau_{fr, motor} \left(\frac{1 - \alpha}{2} \right),$$

where:

- $\tau_{fr, pump} = (1 - \eta_m)\tau$
- $\tau_{fr, motor} = (\eta_m - 1)\tau_{ideal}$

and η_m is the mechanical efficiency, which is interpolated from the user-provided tabulated data.

The Tabulated data - volumetric and mechanical losses parameterization

The leakage flow rate is calculated as:

$$\dot{m}_{leak} = \rho_{avg} q_{loss}(\Delta p, \omega, D),$$

where q_{loss} is interpolated from the **Volumetric loss table, $q_{loss}(dp,w,D)$** parameter, which is based on user-supplied data for pressure gain, shaft angular velocity, and fluid volumetric displacement.

The shaft friction torque is calculated as:

$$\tau_{fr} = \tau_{loss}(\Delta p, \omega, D),$$

where τ_{loss} is interpolated from the **Mechanical loss table, $torque_loss(dp,w,D)$** parameter, which is based on user-supplied data for pressure gain, shaft angular velocity, and fluid volumetric displacement.

Input Signal Parameterization

When you select **Input signal - volumetric and mechanical efficiencies**, ports **EV** and **EM** are enabled. The internal leakage and shaft friction are calculated in the same way as the **Tabulated data - volumetric and mechanical efficiencies** parameterization, except that η_v and η_m are received directly at ports **EV** and **EM**, respectively.

When you select **Input signal - volumetric and mechanical losses**, ports **LV** and **LM** are enabled. These ports receive leakage flow and friction torque as positive physical signals. The leakage flow rate is calculated as:

$$\dot{m}_{leak} = \rho_{avg} q_{LV} \tanh\left(\frac{4\Delta p}{p_{thresh}}\right),$$

where:

- q_{LV} is the leakage flow received at port **LV**.
- p_{thresh} is the **Pressure gain threshold for pump-motor transition** parameter.

The friction torque is calculated as:

$$\tau_{fr} = \tau_{LM} \tanh\left(\frac{4\omega}{\omega_{thresh}}\right),$$

where

- τ_{LM} is the friction torque received at port **LM**.

- ω_{thresh} is the **Angular velocity threshold for pump-motor transition** parameter.

The volumetric and mechanical efficiencies range between the user-defined specified minimum and maximum values. Any values lower or higher than this range will take on the minimum and maximum specified values, respectively.

Pump Operation

The pump flow rate is:

$$\dot{m} = \dot{m}_{\text{ideal}} - \dot{m}_{\text{leak}},$$

where $\dot{m}_{\text{ideal}} = \rho_{\text{avg}} D \cdot \omega$.

The pump torque is:

$$\tau = \tau_{\text{ideal}} + \tau_{fr},$$

where $\tau_{\text{ideal}} = D \cdot \Delta p$.

The mechanical power delivered by the pump shaft is:

$$\varphi_{\text{mech}} = \tau \omega,$$

and the pump hydraulic power is:

$$\varphi_{\text{hyd}} = \frac{\Delta p \dot{m}}{\rho_{\text{avg}}}.$$

To be notified if the block is operating beyond the supplied tabulated data, you can set **Check if operating beyond the octants of supplied tabulated data** to Warning to receive a warning if this occurs, or Error to stop the simulation when this occurs. When using input signals for volumetric or mechanical losses, you can be notified if the simulation surpasses operating modes with the **Check if operating beyond pump mode** parameter.

You can also monitor pump functionality. Set **Check if pressures are less than pump minimum pressure** to Warning to receive a warning if this occurs, or Error to stop the simulation when this occurs.

Ports

Conserving

A — Liquid port

isothermal liquid

Liquid entry or exit port to the pump.

B — Liquid port

isothermal liquid

Liquid entry or exit port to the pump.

R — Mechanical port

mechanical rotational

Rotating shaft angular velocity and torque.

C – Mechanical port

mechanical rotational

Pump casing reference angular velocity and torque.

Input**D – Volumetric displacement, m³/rad**

physical signal

Volumetric displacement of the pump, in m³/rad, specified as a physical signal.

EV – Volumetric efficiency

physical signal

Pump efficiency for fluid displacement, specified as a physical signal. The value must be between 0 and 1.

Dependencies

To enable this port, set **Leakage and friction parameterization** to Input signal - volumetric and mechanical efficiencies.

EM – Mechanical efficiency

physical signal

Pump efficiency for the mechanical delivery of power, specified as a physical signal. The value must be between 0 and 1.

Dependencies

To enable this port, set **Leakage and friction parameterization** to Input signal - volumetric and mechanical efficiencies.

LV – Leakage flow rate, m³/s

physical signal

Pump volumetric losses, in m³/s, specified as a physical signal.

Dependencies

To enable this port, set **Leakage and friction parameterization** to Input signal - volumetric and mechanical losses.

LM – Friction torque, N*m

physical signal

Pump mechanical losses in N*m, specified as a physical signal.

Dependencies

To enable this port, set **Leakage and friction parameterization** to Input signal - volumetric and mechanical losses.

Parameters

Leakage and friction parameterization — Method of calculating leakage flow rate and friction torque

Analytical (default) | Tabulated data - volumetric and mechanical efficiencies | Tabulated data - volumetric and mechanical losses | Input signal - volumetric and mechanical efficiencies | Input signal - volumetric and mechanical losses

Parameterization of the leakage and friction characteristics of the pump.

- In the `Analytical` parameterization, the leakage flow rate and the friction torque are calculated by analytical equations.
- In the `Tabulated data - volumetric and mechanical efficiencies` parameterization, the volumetric and mechanical efficiencies are calculated from the user-supplied **Pressure gain vector, dp** , **Shaft angular velocity vector, w** , and **Displacement vector, D** parameters and interpolated from the 3-D dependent **Volumetric efficiency table, $e_v(dp,w,D)$** and **Mechanical efficiency table, $e_m(dp,w,D)$** tables.
- In the `Tabulated data - volumetric and mechanical loss` parameterization, the leakage flow rate and friction torque are calculated from the user-supplied **Pressure gain vector, dp** ; **Shaft angular velocity vector, w** ; and **Displacement vector, D** parameters and interpolated from the 3-D dependent **Volumetric loss table, $q_loss(dp,w,D)$** and **Mechanical loss table, $torque_loss(dp,w,D)$** tables.
- In the `Input signal - volumetric and mechanical efficiencies` parameterization, the volumetric and mechanical efficiencies are received as physical signals at ports **EV** and **EM**, respectively.
- In the `Input signal - volumetric and mechanical loss` parameterization, the leakage flow rate and friction torque are received as physical signals at ports **LV** and **LM**, respectively.

Nominal displacement — Nominal fluid displacement

30 cm³/rev (default) | scalar

Amount of fluid displaced by shaft rotating under nominal operating conditions.

Dependencies

To enable this parameter, set **Leakage and friction parameterization** to `Analytical`.

Nominal shaft angular velocity — Shaft angular velocity

188 rad/s (default) | scalar

Angular velocity of the shaft under nominal operating conditions.

Dependencies

To enable this parameter, set **Leakage and friction parameterization** to `Analytical`.

Nominal pressure gain — Pressure drop between fluid entry and exit

10 MPa (default) | scalar

Pump pressure gain between the fluid entry and exit under nominal operating conditions.

Dependencies

To enable this parameter, set **Leakage and friction parameterization** to `Analytical`.

Volumetric efficiency at nominal conditions – Ratio of actual flow rate to ideal flow rate at nominal conditions

0.92 (default) | positive scalar in the range of (0,1]

Ratio of actual flow rate to ideal flow rate at nominal conditions.

Dependencies

To enable this parameter, set **Leakage and friction parameterization** to Analytical.

No-load torque – Baseline torque

0 N*m (default) | scalar

Minimum value of torque to overcome seal friction and induce shaft motion.

Dependencies

To enable this parameter, set **Leakage and friction parameterization** to Analytical.

Mechanical efficiency at nominal conditions – Ratio of actual to ideal mechanical power

0.88 (default) | positive scalar

Ratio of actual mechanical power to ideal mechanical power at nominal conditions.

Dependencies

To enable this parameter, set **Leakage and friction parameterization** to Analytical.

Pressure gain vector, dp – Vector of pressure data for tabulated data parameterization

[.1, 1, 2] MPa (default) | 1-by-n vector

Vector of pressure differential values for the tabular parameterization of leakage and torque friction. This vector forms an independent axis with the **Shaft angular velocity vector, w** and the **Displacement vector, D** parameters for the 3-D dependent **Volumetric efficiency table, e_v(dp,w,D)** and **Mechanical efficiency table, e_m(dp,w,D)** parameters. The vector elements must be listed in ascending order.

Dependencies

To enable this parameter, set **Leakage and friction parameterization** to either:

- Tabulated data - volumetric and mechanical efficiencies
- Tabulated data - volumetric and mechanical losses

Shaft angular velocity vector, w – Vector of angular velocity data for tabulated data parameterization

[25, 50, 100, 200, 300, 400] rad/s (default) | 1-by-n vector

Vector of angular velocity data for the tabular parameterization of leakage and torque friction. This vector forms an independent axis with the **Pressure gain vector, dp** and the **Displacement vector, D** parameters for the 3-D dependent **Volumetric efficiency table, e_v(dp,w,D)** and **Mechanical efficiency table, e_m(dp,w,D)** parameters. The vector elements must be listed in ascending order.

Dependencies

To enable this parameter, set **Leakage and friction parameterization** to either:

- Tabulated data - volumetric and mechanical efficiencies
- Tabulated data - volumetric and mechanical losses

Displacement vector, D – Vector of displacement volumes for tabulated data parameterization

`[-30, -19, 19, 30]` cm^3/s (default) | 1-by- n vector

Vector of fluid volumetric displacement data for the tabular parameterization of leakage and torque friction. This vector forms an independent axis with the **Shaft angular velocity vector, w** and the **Pressure gain vector, dp** parameters for the 3-D dependent **Volumetric efficiency table, $e_v(dp,w,D)$** and **Mechanical efficiency table, $e_m(dp,w,D)$** parameters. The vector elements must be listed in ascending order.

Dependencies

To enable this parameter, set **Leakage and friction parameterization** to either:

- Tabulated data - volumetric and mechanical efficiencies
- Tabulated data - volumetric and mechanical losses

Volumetric efficiency table, $e_v(dp,w,D)$ – Volumetric efficiency for tabulated data parameterization

`repmat([.816, .908, .954, .977, .981, .984; .325, .663, .831, .916, .925, .946; .137, .568, .78, .892, .893, .91], 1, 1, 4)` (default) | M -by- N -by- P matrix

M -by- N -by- P matrix of volumetric efficiencies at the specified fluid pressure gain, shaft angular velocity, and volumetric displacement. Linear interpolation is employed between table elements. M , N , and P are the sizes of the corresponding vectors:

- M is the number of vector elements in the **Pressure gain vector, dp** parameter.
- N is the number of vector elements in the **Shaft angular velocity vector, w** parameter.
- P is the number of vector elements in the **Displacement vector, D** parameter.

Dependencies

To enable this parameter, set **Leakage and friction parameterization** to Tabulated data - volumetric and mechanical efficiencies.

Mechanical efficiency table, $e_m(dp,w,D)$ – Mechanical efficiency for tabulated data parameterization

`repmat([.996, .996, .996, .996, .996; .988, .989, .989, .989, .989, .99; .981, .981, .982, .982, .983, .984], 1, 1, 4)` (default) | M -by- N -by- P matrix

M -by- N -by- P matrix of mechanical efficiencies at the specified fluid pressure gain, shaft angular velocity, and displacement. Linear interpolation is employed between table elements. M , N , and P are the sizes of the corresponding vectors:

- M is the number of vector elements in the **Pressure gain vector, dp** parameter.
- N is the number of vector elements in the **Shaft angular velocity vector, w** parameter.
- P is the number of vector elements in the **Displacement vector, D** parameter.

Dependencies

To enable this parameter, set **Leakage and friction parameterization** to Tabulated data - volumetric and mechanical efficiencies.

Volumetric loss table, `q_loss(dp,w,D)` — Volumetric losses for tabulated data parameterization

```
repmat([.023, .023, .023, .023, .0285, .032; .0844, .0842, .0845, .084, .1125
, .108; .1079, .108, .11, .108, .1605, .18] * 1e-3, 1, 1, 4)m^3/s (default) |
numerical array
```

M -by- N -by- P matrix of volumetric leakage at the specified fluid pressure gain, shaft angular velocity, and displacement. Linear interpolation is employed between table elements. M , N , and P are the sizes of the corresponding vectors:

- M is the number of vector elements in the **Pressure gain vector, `dp`** parameter.
- N is the number of vector elements in the **Shaft angular velocity vector, `w`** parameter.
- P is the number of vector elements in the **Displacement vector, `D`** parameter.

Dependencies

To enable this parameter, set **Leakage and friction parameterization** to Tabulated data - volumetric and mechanical losses.

Mechanical loss table, `torque_loss(dp,w,D)` — Mechanical losses for tabulated data parameterization

```
repmat([.002, .002, .002, .002, .002; .0607, .0556, .0556, .0556, .0556
, .0505; .1937, .1937, .1833, .1833, .1729, .1626], 1, 1, 4) N*m (default) |
numerical array
```

M -by- N -by- P matrix of friction torque at the specified fluid pressure gain, shaft angular velocity, and displacement. Linear interpolation is employed between table elements. M , N , and P are the sizes of the corresponding vectors:

- M is the number of vector elements in the **Pressure gain vector, `dp`** parameter.
- N is the number of vector elements in the **Shaft angular velocity vector, `w`** parameter.
- P is the number of vector elements in the **Displacement vector, `D`** parameter.

Dependencies

To enable this parameter, set **Leakage and friction parameterization** to Tabulated data - volumetric and mechanical loss.

Minimum volumetric efficiency — Minimum value of volumetric efficiency

```
1e-3 (default) | positive scalar in the range of (0,1]
```

Minimum value of volumetric efficiency. If the input signal is below this value, the volumetric efficiency is set to the minimum volumetric efficiency.

Dependencies

To enable this parameter, set **Leakage and friction parameterization** to Input signal - volumetric and mechanical efficiencies.

Maximum volumetric efficiency – Maximum value of volumetric efficiency

1 (default) | positive scalar in the range of (0,1]

Maximum value of volumetric efficiency. If the input signal is above this value, the volumetric efficiency is set to the maximum volumetric efficiency.

Dependencies

To enable this parameter, set **Leakage and friction parameterization** to Input signal - volumetric and mechanical efficiencies.

Minimum mechanical efficiency – Minimum value of mechanical efficiency

1e-3 (default) | positive scalar in the range of (0,1]

Minimum value of mechanical efficiency. If the input signal is below this value, the mechanical efficiency is set to the minimum mechanical efficiency.

Dependencies

To enable this parameter, set **Leakage and friction parameterization** to Input signal - volumetric and mechanical efficiencies.

Maximum mechanical efficiency – Maximum value of mechanical efficiency

1 (default) | positive scalar in the range of (0,1]

Maximum value of mechanical efficiency. If the input signal is above this value, the mechanical efficiency is set to the maximum mechanical efficiency.

Dependencies

To enable this parameter, set **Leakage and friction parameterization** to Input signal - volumetric and mechanical efficiencies.

Pressure gain threshold for pump-motor transition – Pressure threshold for mode transition

1e-3 MPa (default) | positive scalar

Pump pressure gain that indicates the transition threshold between pump and motor functionality. A transition region is defined around 0 MPa between the positive and negative values of the pressure gain threshold. Within this transition region, the computed leakage flow rate and friction torque are adjusted according to the transition term α to ensure smooth transition from one mode to the other.

Dependencies

To enable this parameter, set **Leakage and friction parameterization** to either:

- Tabulated data - volumetric and mechanical efficiencies
- Input signal - volumetric and mechanical efficiencies
- Input signal - volumetric and mechanical losses

Angular velocity threshold for pump-motor transition – Angular velocity threshold for mode transition

10 rad/s (default) | positive scalar

Shaft angular velocity that indicates the transition threshold between motor and pump functionality. A transition region is defined around 0 rad/s between the positive and negative values of the angular

velocity threshold. Within this transition region, the computed leakage flow rate and friction torque are adjusted according to the transition term α to ensure smooth transition from one mode to the other.

Dependencies

To enable this parameter, set **Leakage and friction parameterization** to:

- Tabulated data - volumetric and mechanical efficiencies
- Input signal - volumetric and mechanical efficiencies
- Input signal - volumetric and mechanical loss

Displacement threshold for pump-motor transition — Displacement threshold for mode transition

0.1 cm³/s (default) | positive scalar

Volumetric displacement that indicates the transition threshold between pump and motor functionality. A transition region is defined around 0 cm³/s between the positive and negative values of the displacement threshold. Within this transition region, the computed leakage flow rate and friction torque is adjusted according to the transition term α to ensure smooth transition from one mode to the other. It is also used to transition the ideal mass flow rate when the sign of **D** changes.

Check if operating beyond the octants of supplied tabulated data — Whether to notify if extents of supplied data are surpassed

None (default) | Warning | Error

Whether to notify if the extents of the supplied data are surpassed. Select Warning to be notified when the block uses values beyond the supplied data range. Select Error to stop the simulation when the block uses values beyond the supplied data range.

Dependencies

To enable this parameter, set **Leakage and friction parameterization** to:

- Tabulated data - volumetric and mechanical efficiencies
- Tabulated data - volumetric and mechanical losses

Check if operating beyond pump mode — Whether to notify if block operates outside of the pump mode functionality

None (default) | Warning | Error

Whether to notify if the block operates outside of the pump mode functionality. Select Warning to be notified when the block operates in the forward or reverse motor modes. Select Error to stop the simulation when the block operates in the forward or reverse motor modes.

Dependencies

To enable this parameter, set **Leakage and friction parameterization** to Input signal - volumetric and mechanical losses.

Check if pressures are less than pump minimum pressure — Whether to notify if fluid exit pressure is low

None (default) | Warning | Error

Whether to notify if the fluid at port **A** and **B** experiences low pressure. Select **Warning** to be notified when the pressure falls below a minimum specified value. Select **Error** to stop the simulation when the pressure falls below a minimum specified value.

The parameter helps identify potential conditions for cavitation, when the fluid pressure falls below the fluid vapor pressure.

Pump minimum pressure — Lower threshold of acceptable pressure at the pump outlet

0.101325 MPa (default) | positive scalar

Lower threshold of acceptable pressure at the pump inlet or outlet.

Dependencies

To enable this parameter, set **Check if pressures are less than pump minimum pressure** to either:

- Warning
- Error

See Also

Variable-Displacement Pump (TL) | Fixed-Displacement Pump (IL) | Pressure-Compensated Pump (IL) | Centrifugal Pump (IL) | Variable-Displacement Motor (IL)

Topics

Introduced in R2020a

Pressure-Compensated Pump (IL)

Constant-pressure, variable-displacement pump in an isothermal liquid network

Library: Simscape / Fluids / Isothermal Liquid / Pumps & Motors

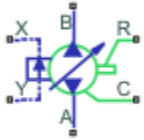

Description

The Pressure-Compensated Pump (IL) block models a constant-pressure, variable-displacement pump in an isothermal liquid network. The pump displacement is controlled by the differential pressure, $p_{control}$, measured between ports **X** and **Y**. When this pressure exceeds the **Set pressure differential**, the fluid displacement is adjusted according to the pump **Leakage and friction parameterization**. The variable-displacement functionality occurs within the **Pressure regulation range** between the **Maximum displacement**, at p_{set} , and the **Minimum displacement**, at p_{max} .

The fluid may move from port **A** to port **B**, called *forward mode*, or from port **B** to port **A**, called *reverse mode*. Pump mode operation occurs when there is a pressure gain in the direction of the flow. Motor mode operation occurs when there is a pressure drop in the direction of the flow.

Shaft rotation corresponds to the sign of the fluid volume moving through the pump. Positive fluid displacement corresponds to positive shaft rotation in forward mode. Negative fluid displacement corresponds to negative shaft angular velocity in forward mode.

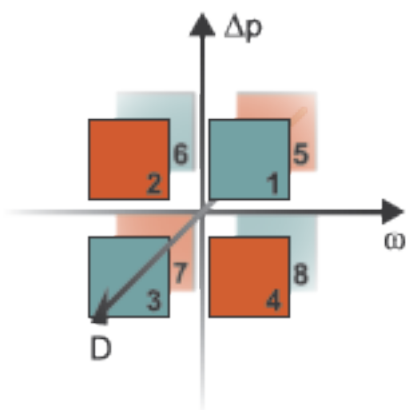

Operation Modes

The block has eight modes of operation. The working mode depends on the pressure gain from port **A** to port **B**, $\Delta p = p_B - p_A$; the angular velocity, $\omega = \omega_R - \omega_C$; and the fluid volumetric displacement, set by the pressure differential. The figure above maps these modes to the octants of a Δp - ω - D chart:

- Mode 1, *Forward Pump*: Positive shaft angular velocity causes a pressure increase from port **A** to port **B** and flow from port **A** to port **B**.
- Mode 2, *Reverse Motor* : Flow from port **B** to port **A** causes a pressure decrease from **B** to **A** and negative shaft angular velocity.
- Mode 3, *Reverse Pump*: Negative shaft angular velocity causes a pressure increase from port **B** to port **A** and flow from **B** to **A**.
- Mode 4, *Forward Motor*: Flow from port **A** to **B** causes a pressure decrease from **A** to **B** and positive shaft angular velocity.
- Mode 5, *Reverse Motor* : Flow from port **B** to port **A** causes a pressure decrease from **B** to **A** and positive shaft angular velocity.
- Mode 6, *Forward Pump*: Negative shaft angular velocity causes pressure increase from **A** to **B** and flow from **A** to **B**.
- Mode 7, *Forward Motor*: Flow from port **A** to **B** causes a pressure decrease from **A** to **B** and negative shaft angular velocity.
- Mode 8, *Reverse Pump*: Positive shaft angular velocity causes a pressure increase from port **B** to port **A** and flow from **B** to **A**.

The block has analytical, lookup table, and physical signal parameterizations. When using tabulated data or an input signal for parameterization, you can choose to characterize pump operation based on efficiency or losses.

The threshold parameters **Pressure gain threshold for pump-motor transition**, **Angular velocity threshold for pump-motor transition**, and **Displacement threshold for pump-motor transition** identify regions where numerically smoothed flow transition between the pump operational modes can occur. For the pressure and angular velocity thresholds, choose a transition region that provides some margin for the transition term, but which is small enough relative to the typical pump pressure gain and angular velocity so that it will not impact calculation results. For the displacement threshold, choose a threshold value that is smaller than the typical displacement volume during normal operation.

Analytical Leakage and Friction Parameterization

If you set **Leakage and friction parameterization** to `Analytical`, the block calculates leakage and friction from constant values for shaft velocity, pressure gain, and torque. The leakage flow rate, which is correlated with the pressure differential over the pump, is calculated as:

$$\dot{m}_{leak} = K\rho_{avg}\Delta p,$$

where:

- Δp_{nom} is $p_B - p_A$.
- ρ_{avg} is the average fluid density.
- K is the Hagen-Poiseuille coefficient for analytical loss,

$$K = \frac{D_{nom}\omega_{nom}(1 - \eta_{v, nom})}{\Delta p_{nom}},$$

where:

- D_{nom} is the **Nominal displacement**.

- ω_{nom} is the **Nominal shaft angular velocity**.
- η_{nom} is the **Volumetric efficiency at nominal conditions**.
- Δp_{nom} is the **Nominal pressure gain**.

The friction torque, which is related to the pump pressure differential, is calculated as:

$$\tau_{fr} = \left(\tau_0 + k \left| \Delta p \frac{D}{D_{nom}} \right| \right) \tanh \left(\frac{4\omega}{5 \times 10^{-5} \omega_{nom}} \right),$$

where:

- τ_0 is the **No-load torque**.
- k is the friction torque vs. pressure gain coefficient at nominal displacement, which is determined from the **Mechanical efficiency at nominal conditions**, $\eta_{m,nom}$:

$$k = \frac{\tau_{fr,nom} - \tau_0}{\Delta p_{nom}}.$$

$\tau_{fr,nom}$ is the friction torque at nominal conditions:

$$\tau_{fr,nom} = \left(\frac{1 - \eta_{m,nom}}{\eta_{m,nom}} \right) D_{nom} \Delta p_{nom}.$$

- ω is the relative shaft angular velocity, or $\omega_R - \omega_C$.

Tabulated Data Parameterizations

When using tabulated data for pump efficiencies or losses, you can provide data for one or more of the pump operational modes. The signs of the tabulated data determine the operational regime of the block. When data is provided for less than eight operational modes, the block calculates the complementing data for the other mode(s) by extending the given data into the remaining octants.

The Tabulated data - volumetric and mechanical efficiencies parameterization

The leakage flow rate is calculated as:

$$\dot{m}_{leak} = \dot{m}_{leak,pump} \left(\frac{1 + \alpha}{2} \right) + \dot{m}_{leak,motor} \left(\frac{1 - \alpha}{2} \right),$$

where:

- $\dot{m}_{leak,pump} = (1 - \eta_v) \dot{m}_{ideal}$
- $\dot{m}_{leak,motor} = (\eta_v - 1) \dot{m}$

and η_v is the volumetric efficiency, which is interpolated from the user-provided tabulated data. The transition term, α , is

$$\alpha = \tanh \left(\frac{4\Delta p}{\Delta p_{threshold}} \right) \tanh \left(\frac{4\omega}{\omega_{threshold}} \right) \tanh \left(\frac{4D}{D_{threshold}} \right),$$

where:

- Δp is $p_B - p_A$.

- $p_{\text{threshold}}$ is the **Pressure gain threshold for pump-motor transition**.
- ω is $\omega_R - \omega_C$.
- $\omega_{\text{threshold}}$ is the **Angular velocity threshold for pump-motor transition**.

The friction torque is calculated as:

$$\tau_{fr} = \tau_{fr, pump} \left(\frac{1 + \alpha}{2} \right) + \tau_{fr, motor} \left(\frac{1 - \alpha}{2} \right),$$

where:

- $\tau_{fr, pump} = (1 - \eta_m)\tau$
- $\tau_{fr, motor} = (\eta_m - 1)\tau_{ideal}$

and η_m is the mechanical efficiency, which is interpolated from the user-provided tabulated data.

The Tabulated data - volumetric and mechanical losses parameterization

The leakage flow rate is calculated as:

$$\dot{m}_{leak} = \rho_{avg} q_{loss}(\Delta p, \omega, D),$$

where q_{loss} is interpolated from the **Volumetric loss table, $q_{loss}(dp, w, D)$** parameter, which is based on user-supplied data for pressure gain, shaft angular velocity, and fluid volumetric displacement.

The shaft friction torque is calculated as:

$$\tau_{fr} = \tau_{loss}(\Delta p, \omega, D),$$

where τ_{loss} is interpolated from the **Mechanical loss table, $\tau_{loss}(dp, w, D)$** parameter, which is based on user-supplied data for pressure gain, shaft angular velocity, and fluid volumetric displacement.

Input Signal Parameterization

When you select Input signal - volumetric and mechanical efficiencies, ports **EV** and **EM** are enabled. The internal leakage and shaft friction are calculated in the same way as the Tabulated data - volumetric and mechanical efficiencies parameterization, except that η_v and η_m are received directly at ports **EV** and **EM**, respectively.

When you select Input signal - volumetric and mechanical losses, ports **LV** and **LM** are enabled. These ports receive leakage flow and friction torque as positive physical signals. The leakage flow rate is calculated as:

$$\dot{m}_{leak} = \rho_{avg} q_{LV} \tanh\left(\frac{4\Delta p}{p_{thresh}}\right),$$

where:

- q_{LV} is the leakage flow received at port **LV**.
- p_{thresh} is the **Pressure gain threshold for pump-motor transition** parameter.

The friction torque is calculated as:

$$\tau_{fr} = \tau_{LM} \tanh\left(\frac{4\omega}{\omega_{thresh}}\right),$$

where

- τ_{LM} is the friction torque received at port **LM**.
- ω_{thresh} is the **Angular velocity threshold for pump-motor transition** parameter.

The volumetric and mechanical efficiencies range between the user-defined specified minimum and maximum values. Any values lower or higher than this range will take on the minimum and maximum specified values, respectively.

Pump Operation

The pump flow rate is:

$$\dot{m} = \dot{m}_{ideal} - \dot{m}_{leak},$$

where $\dot{m}_{ideal} = \rho_{avg} D \cdot \omega$.

The pump torque is:

$$\tau = \tau_{ideal} + \tau_{fr},$$

where $\tau_{ideal} = D \cdot \Delta p$.

The mechanical power delivered by the pump shaft is:

$$\varphi_{mech} = \tau\omega,$$

and the pump hydraulic power is:

$$\varphi_{hyd} = \frac{\Delta p \dot{m}}{\rho_{avg}}.$$

To be notified if the block is operating beyond the supplied tabulated data, set **Check if operating beyond the octants of supplied tabulated data** to Warning to receive a warning if this occurs, or Error to stop the simulation when this occurs. For parameterization by input signal for volumetric or mechanical losses, you can be notified if the simulation surpasses operating modes with the **Check if operating beyond pump mode** parameter.

You can also monitor pump functionality. Set **Check if pressures are less than pump minimum pressure** to Warning to receive a warning if this occurs, or Error to stop the simulation when this occurs.

Displacement Parameterization

The linear parameterization of the pump displacement is:

$$D = \hat{p}(D_{min} - D_{max}) + D_{max},$$

where the normalized pressure, \hat{p} , is

$$\hat{p} = \frac{p_{control} - p_{set}}{p_{max} - p_{set}},$$

where p_{max} is the sum of the **Set pressure differential** and the **Pressure regulation range**.

Displacement Dynamics

If displacement dynamics are modeled, a lag is introduced to the flow response to the modeled control pressure. $p_{control}$ becomes the dynamic control pressure, p_{dyn} ; otherwise, $p_{control}$ is the steady-state pressure. The instantaneous change in dynamic control pressure is calculated based on the **Time constant**, τ :

$$\dot{p}_{dyn} = \frac{p_{control} - p_{dyn}}{\tau}.$$

By default, **Displacement dynamics** is set to Off.

Numerically-Smoothed Pressure

At the extremes of the control pressure range, you can maintain numerical robustness in your simulation by adjusting the block **Smoothing factor**. A smoothing function is applied to every calculated control pressure, but primarily influences the simulation at the extremes of this range.

The **Smoothing factor**, s , is applied to the normalized pressure, \hat{p} :

$$\hat{p}_{smoothed} = \frac{1}{2} + \frac{1}{2} \sqrt{\hat{p}^2 + \left(\frac{s}{4}\right)^2} - \frac{1}{2} \sqrt{(\hat{p} - 1)^2 + \left(\frac{s}{4}\right)^2},$$

and the smoothed pressure is:

$$p_{smoothed} = \hat{p}_{smoothed}(p_{max} - p_{set}) + p_{set}.$$

Ports

Conserving

A — Liquid port

isothermal liquid

Entry or exit port of the liquid to or from the pump.

B — Liquid port

isothermal liquid

Entry or exit port of the liquid to or from the pump.

X — Pressure reference P_x , MPa

isothermal liquid

Control pressure in units of MPa, denoted P_x . The control pressure, $P_x - P_y$, is compared against the **Set pressure differential** to trigger or moderate variable pump displacement.

Y — Pressure reference P_y , MPa

isothermal liquid

Control pressure in units of MPa, denoted P_y . The control pressure, $P_x - P_y$, is compared against the **Set pressure differential** to trigger or moderate variable pump displacement.

R – Mechanical port

mechanical rotational

Rotating shaft angular velocity and torque.

C – Mechanical port

mechanical rotational

Pump casing reference angular velocity and torque.

EV – Volumetric efficiency

physical signal

Pump efficiency for fluid displacement, specified as a physical signal. The value must be between 0 and 1.

Dependencies

To enable this port, set **Leakage and friction parameterization** to Input signal - volumetric and mechanical efficiencies.

EM – Mechanical efficiency

physical signal

Pump efficiency for the mechanical supply of energy, specified as a physical signal. The value must be between 0 and 1.

Dependencies

To enable this port, set **Leakage and friction parameterization** to Input signal - volumetric and mechanical efficiencies.

LV – Leakage flow rate, m³/s

physical signal

Pump losses associated with fluid displacement in m³/s, specified as a physical signal.

Dependencies

To enable this port, set **Leakage and friction parameterization** to Input signal - volumetric and mechanical losses.

LM – Friction torque, N*m

physical signal

Pump losses associated with the mechanical supply of energy in N*m, specified as a physical signal.

Dependencies

To enable this port, set **Leakage and friction parameterization** to Input signal - volumetric and mechanical losses.

Parameters

Pump

Leakage and friction parameterization — Method of calculating leakage flow rate and friction torque

Analytical (default) | Tabulated data - volumetric and mechanical efficiencies | Tabulated data - volumetric and mechanical losses | Input signal - volumetric and mechanical efficiencies | Input signal - volumetric and mechanical losses

Parameterization of the leakage and friction characteristics of the pump.

- In the **Analytical** parameterization, the leakage flow rate and the friction torque are calculated by analytical equations.
- In the **Tabulated data - volumetric and mechanical efficiencies** parameterization, the volumetric and mechanical efficiencies are calculated from the user-supplied **Pressure gain vector, dp** , **Shaft angular velocity vector, w** , and **Displacement vector, D** parameters and interpolated from the 3-D **Volumetric efficiency table, $e_v(dp,w,D)$** and **Mechanical efficiency table, $e_m(dp,w,D)$** tables.
- In the **Tabulated data - volumetric and mechanical losses** parameterization, the leakage flow rate and friction torque are calculated from the user-supplied **Pressure gain vector, dp** , **Shaft angular velocity vector, w** , and **Displacement vector, D** parameters and interpolated from the 3-D **Volumetric loss table, $q_loss(dp,w,D)$** and **Mechanical loss table, $torque_loss(dp,w,D)$** parameters.
- In the **Input signal - volumetric and mechanical efficiencies** parameterization, the volumetric and mechanical efficiencies are received as physical signals at ports **EV** and **EM**, respectively.
- In the **Input signal - volumetric and mechanical loss** parameterization, the leakage flow rate and friction torque are received as physical signals at ports **LV** and **LM**, respectively.

Nominal displacement — Fixed-volume fluid displacement

30 cm³/rev (default) | scalar

Amount of fluid displaced by shaft rotating under nominal operating conditions.

Dependencies

To enable this parameter, set **Leakage and friction parameterization** to **Analytical**.

Nominal shaft angular velocity — Shaft angular velocity

188 rad/s (default) | scalar

Angular velocity of the shaft under nominal operating conditions.

Dependencies

To enable this parameter, set **Leakage and friction parameterization** to **Analytical**.

Nominal pressure gain — Pressure gain between fluid entry and exit

10 MPa (default) | scalar

Pump pressure gain between the fluid entry and exit under nominal operating conditions.

Dependencies

To enable this parameter, set **Leakage and friction parameterization** to Analytical.

Volumetric efficiency at nominal conditions – Ratio of actual flow rate to ideal flow rate

0.92 (default) | positive scalar in the range of (0,1]

Ratio of actual flow rate to ideal flow rate at nominal conditions.

Dependencies

To enable this parameter, set **Leakage and friction parameterization** to Analytical.

No-load torque – Baseline torque

0 N*m (default) | scalar

Minimum value of torque to overcome seal friction and induce shaft motion.

Dependencies

To enable this parameter, set **Leakage and friction parameterization** to Analytical.

Mechanical efficiency at nominal conditions – Ratio of actual to ideal mechanical power

0.88 (default) | positive scalar

Ratio of actual mechanical power to ideal mechanical power at nominal conditions.

Dependencies

To enable this parameter, set **Leakage and friction parameterization** to Analytical.

Pressure gain vector, dp – Vector of pressure data for tabulated data parameterization

[.1, 1, 2] MPa (default) | 1-by-*n* vector

Vector of pressure differential values for the tabular parameterization of leakage and torque friction. This vector forms an independent axis with the **Shaft angular velocity vector, w** and the **Displacement vector, D** parameters for the 3-D dependent **Volumetric efficiency table, e_v(dp,w,D)** and **Mechanical efficiency table, e_m(dp,w,D)** parameters. The vector elements must be listed in ascending order.

Dependencies

To enable this parameter, set **Leakage and friction parameterization** to either:

- Tabulated data - volumetric and mechanical efficiencies
- Tabulated data - volumetric and mechanical losses

Shaft angular velocity vector, w – Vector of angular velocity data for tabulated data parameterization

[25, 50, 100, 200, 300, 400] rad/s (default) | 1-by-*n* vector

Vector of angular velocity data for the tabular parameterization of leakage and torque friction. This vector forms an independent axis with the **Pressure gain vector, dp** and the **Displacement vector, D** parameters for the 3-D dependent **Volumetric efficiency table, e_v(dp,w,D)** and **Mechanical efficiency table, e_m(dp,w,D)** parameters. The vector elements must be listed in ascending order.

Dependencies

To enable this parameter, set **Leakage and friction parameterization** to either:

- Tabulated data - volumetric and mechanical efficiencies
- Tabulated data - volumetric and mechanical losses

Displacement vector, D – Vector of displacement volumes for tabulated data parameterization

`[-30, -19, 19, 30]` cm³/s (default) | 1-by-*n* vector

Vector of fluid volumetric displacement data for the tabular parameterization of leakage and torque friction. This vector forms an independent axis with the **Shaft angular velocity vector, w** and the **Pressure gain vector, dp** parameters for the 3-D dependent **Volumetric efficiency table, e_v(dp,w,D)** and **Mechanical efficiency table, e_m(dp,w,D)** parameters. The vector elements must be listed in ascending order.

Dependencies

To enable this parameter, set **Leakage and friction parameterization** to either:

- Tabulated data - volumetric and mechanical efficiencies
- Tabulated data - volumetric and mechanical losses

Volumetric efficiency table, e_v(dp,w,D) – Volumetric efficiency for tabulated data parameterization

`repmat([.816, .908, .954, .977, .981, .984; .325, .663, .831, .916, .925, .946; .137, .568, .78, .892, .893, .91], 1, 1, 4)` (default) | *M*-by-*N*-by-*P* matrix

M-by-*N*-by-*P* matrix of volumetric efficiencies at the specified fluid pressure gain, shaft angular velocity, and volumetric displacement. Linear interpolation is employed between table elements. *M*, *N*, and *P* are the sizes of the corresponding vectors:

- *M* is the number of vector elements in the **Pressure gain vector, dp** parameter.
- *N* is the number of vector elements in the **Shaft angular velocity vector, w** parameter.
- *P* is the number of vector elements in the **Displacement vector, D** parameter.

Dependencies

To enable this parameter, set **Leakage and friction parameterization** to Tabulated data - volumetric and mechanical efficiencies.

Mechanical efficiency table, e_m(dp,w,D) – Mechanical efficiency for tabulated data parameterization

`repmat([.996, .996, .996, .996, .996, .996; .988, .989, .989, .989, .989, .99; .981, .981, .982, .982, .983, .984], 1, 1, 4)` (default) | *M*-by-*N*-by-*P* matrix

M-by-*N*-by-*P* matrix of mechanical efficiencies at the specified fluid pressure gain, shaft angular velocity, and displacement. Linear interpolation is employed between table elements. *M*, *N*, and *P* are the sizes of the corresponding vectors:

- *M* is the number of vector elements in the **Pressure gain vector, dp** parameter.
- *N* is the number of vector elements in the **Shaft angular velocity vector, w** parameter.

- P is the number of vector elements in the **Displacement vector, D** parameter.

Dependencies

To enable this parameter, set **Leakage and friction parameterization** to Tabulated data - volumetric and mechanical efficiencies.

Volumetric loss table, $q_loss(dp,w,D)$ — Volumetric losses for tabulated data parameterization

```
repmat([.023, .023, .023, .023, .0285, .032; .0844, .0842, .0845, .084, .1125
, .108; .1079, .108, .11, .108, .1605, .18] * 1e-3, 1, 1, 4)m^3/s (default) |
numerical array
```

M -by- N -by- P matrix of volumetric leakage at the specified fluid pressure gain, shaft angular velocity, and displacement. Linear interpolation is employed between table elements. M , N , and P are the sizes of the corresponding vectors:

- M is the number of vector elements in the **Pressure gain vector, dp** parameter.
- N is the number of vector elements in the **Shaft angular velocity vector, w** parameter.
- P is the number of vector elements in the **Displacement vector, D** parameter.

Dependencies

To enable this parameter, set **Leakage and friction parameterization** to Tabulated data - volumetric and mechanical loss.

Mechanical loss table, $torque_loss(dp,w,D)$ — Mechanical losses for tabulated data parameterization

```
repmat([.002, .002, .002, .002, .002, .002; .0607, .0556, .0556, .0556, .0556
, .0505; .1937, .1937, .1833, .1833, .1729, .1626], 1, 1, 4) N*m (default) |
numerical array
```

M -by- N -by- P matrix of friction torque at the specified fluid pressure gain, shaft angular velocity, and displacement. Linear interpolation is employed between table elements. M , N , and P are the sizes of the corresponding vectors:

- M is the number of vector elements in the **Pressure gain vector, dp** parameter.
- N is the number of vector elements in the **Shaft angular velocity vector, w** parameter.
- P is the number of vector elements in the **Displacement vector, D** parameter.

Dependencies

To enable this parameter, set **Leakage and friction parameterization** to Tabulated data - volumetric and mechanical loss.

Minimum volumetric efficiency — Minimum value of volumetric efficiency

1e-3 (default) | positive scalar in the range of (0,1]

Minimum value of volumetric efficiency. If the input signal is below this value, the volumetric efficiency is set to the minimum volumetric efficiency.

Dependencies

To enable this parameter, set **Leakage and friction parameterization** to Input signal - volumetric and mechanical efficiencies.

Maximum volumetric efficiency – Maximum value of volumetric efficiency

1 (default) | positive scalar in the range of (0,1]

Maximum value of volumetric efficiency. If the input signal is above this value, the volumetric efficiency is set to the maximum volumetric efficiency.

Dependencies

To enable this parameter, set **Leakage and friction parameterization** to Input signal - volumetric and mechanical efficiencies.

Minimum mechanical efficiency – Minimum value of mechanical efficiency

1e-3 (default) | positive scalar in the range of (0,1]

Minimum value of mechanical efficiency. If the input signal is below this value, the mechanical efficiency is set to the minimum mechanical efficiency.

Dependencies

To enable this parameter, set **Leakage and friction parameterization** to Input signal - volumetric and mechanical efficiencies.

Maximum mechanical efficiency – Maximum value of mechanical efficiency

1 (default) | positive scalar in the range of (0,1]

Maximum value of mechanical efficiency. If the input signal is above this value, the mechanical efficiency is set to the maximum mechanical efficiency.

Dependencies

To enable this parameter, set **Leakage and friction parameterization** to Input signal - volumetric and mechanical efficiencies.

Pressure gain threshold for pump-motor transition – Pressure threshold for mode transition

1e-3 MPa (default) | positive scalar

Threshold pressure gain value for the transition between pump and motor functionality. A transition region is defined around 0 MPa between the positive and negative values of the pressure gain threshold. Within this transition region, the computed leakage flow rate and friction torque are adjusted according to the transition term α to ensure smooth transition from one mode to the other.

Dependencies

To enable this parameter, set **Leakage and friction parameterization** to either:

- Tabulated data - volumetric and mechanical efficiencies
- Input signal - volumetric and mechanical efficiencies
- Input signal - volumetric and mechanical losses

Angular velocity threshold for pump-motor transition – Angular velocity threshold for mode transition

10 rad/s (default) | positive scalar

Threshold angular velocity value for the transition between motor and pump functionality. A transition region is defined around 0 rad/s between the positive and negative values of the angular

velocity threshold. Within this transition region, the computed leakage flow rate and friction torque are adjusted according to the transition term α to ensure smooth transition from one mode to the other.

Dependencies

To enable this parameter, set **Leakage and friction parameterization** to:

- Tabulated data - volumetric and mechanical efficiencies
- Input signal - volumetric and mechanical efficiencies
- Input signal - volumetric and mechanical loss

Check if operating beyond the octants of supplied tabulated data – Whether to notify if extents of supplied data are surpassed

None (default) | Warning | Error

Whether to notify if the extents of the supplied data are surpassed. Select Warning to be notified when the block uses values beyond the supplied data range. Select Error to stop the simulation when the block uses values beyond the supplied data range.

Dependencies

To enable this parameter, set **Leakage and friction parameterization** to:

- Tabulated data - volumetric and mechanical efficiencies
- Tabulated data - volumetric and mechanical losses

Check if operating beyond pump mode – Whether to notify if block operates outside of the pump mode functionality

None (default) | Warning | Error

Whether to notify if block operates outside of the pump mode functionality. Select Warning to be notified when the block operates in the forward or reverse motor modes. Select Error to stop the simulation when the block operates in the forward or reverse motor modes.

Dependencies

To enable this parameter, set **Leakage and friction parameterization** to Input signal - volumetric and mechanical losses.

Check if pressures are less than pump minimum pressure – Whether to notify if fluid exit pressure is low

None (default) | Warning | Error

Whether to notify if the fluid at port **A** or **B** experiences low pressure. Select Warning to be notified when the outlet pressure falls below a minimum specified value. Select Error to stop the simulation when the outlet pressure falls below a minimum specified value.

The parameter helps to identify potential conditions for cavitation, when the fluid pressure falls below the fluid vapor pressure.

Pump minimum pressure – Lower threshold of acceptable pressure at the pump outlet

0.101325 MPa (default) | positive scalar

Lower threshold of acceptable pressure at the pump inlet or outlet.

Dependencies

To enable this parameter, set **Check if pressures are less than pump minimum pressure** to:

- Warning
- Error

Pressure Compensation**Maximum displacement — Upper limit to pump displacement**

30 cm³/rev (default) | scalar

Upper limit to pump displacement.

Minimum displacement — Lower limit to pump displacement

0.1 cm³/rev (default) | scalar

Lower limit to pump displacement.

Set pressure differential — Threshold value for variable-displacement functionality

10 MPa (default) | positive scalar

Threshold value beyond which pump displacement is adjusted.

Pressure regulation range — Variable-displacement operational range

0.6 MPa (default) | positive scalar

Variable-displacement operational range. The pump operates between the **Set pressure differential** and the pump maximum pressure, which is $p_{set} + p_{regulation}$.

Displacement dynamics — Whether to account for flow response to displacement changes

Off (default) | On

Whether to account for transient effects to the fluid system due to changes in pump fluid displacement. Setting **Displacement dynamics** to On approximates the condition change by introducing a first-order lag in the flow response. The magnitude of the **Time constant** also impacts the modeled displacement dynamics.

Time constant — Flow response time constant

0.1 s (default) | positive scalar

Constant that captures the time required for the fluid to reach steady-state when changing the fluid displacement. This parameter impacts the modeled displacement dynamics.

See Also

Variable-Displacement Pump (IL) | Fixed-Displacement Pump (IL) | Centrifugal Pump (IL) | Jet Pump (IL)

Topics**Introduced in R2020a**

Variable-Displacement Pump (TL)

Variable-displacement bidirectional thermal liquid pump

Library: Simscape / Fluids / Thermal Liquid / Pumps & Motors



Description

The Variable-Displacement Pump block represents a device that extracts power from a mechanical rotational network and delivers it to a thermal liquid network. The pump displacement varies during simulation according to the physical signal input specified at port **D**.

Ports **A** and **B** represent the pump inlets. Ports **R** and **C** represent the motor drive shaft and case. During normal operation, the pressure gain from port **A** to port **B** is positive if the angular velocity at port **R** relative to port **C** is positive also. This operation mode is referred to here as *forward pump*.

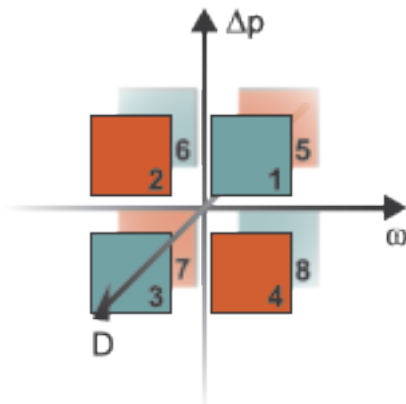

Operation Modes

The block has eight modes of operation. The working mode depends on the pressure gain from port **A** to port **B**, $\Delta p = p_B - p_A$; the angular velocity, $\omega = \omega_R - \omega_C$; and the fluid volumetric displacement at port **D**. The figure above maps these modes to the octants of a Δp - ω - D chart:

- Mode **1**, *Forward Pump*: Positive shaft angular velocity causes a pressure increase from port **A** to port **B** and flow from port **A** to port **B**.
- Mode **2**, *Reverse Motor*: Flow from port **B** to port **A** causes a pressure decrease from **B** to **A** and negative shaft angular velocity.
- Mode **3**, *Reverse Pump*: Negative shaft angular velocity causes a pressure increase from port **B** to port **A** and flow from **B** to **A**.
- Mode **4**, *Forward Motor*: Flow from port **A** to **B** causes a pressure decrease from **A** to **B** and positive shaft angular velocity.

- Mode 5, *Reverse Motor*: Flow from port **B** to port **A** causes a pressure decrease from **B** to **A** and positive shaft angular velocity.
- Mode 6, *Forward Pump*: Negative shaft angular velocity causes pressure increase from **A** to **B** and flow from **A** to **B**.
- Mode 7, *Forward Motor*: Flow from port **A** to **B** causes a pressure decrease from **A** to **B** and negative shaft angular velocity.
- Mode 8, *Reverse Pump*: Positive shaft angular velocity causes a pressure increase from port **B** to port **A** and flow from **B** to **A**.

The response time of the pump is considered negligible in comparison with the system response time. The pump is assumed to reach steady state nearly instantaneously and is treated as a quasi-steady component.

Energy Balance

Mechanical work done by the pump is associated with an energy exchange. The governing energy balance equation is:

$$\phi_A + \phi_B + P_{hydro} = 0,$$

where:

- Φ_A and Φ_B are energy flow rates at ports **A** and **B**, respectively.
- P_{hydro} is the pump hydraulic power. It is a function of the pressure difference between pump ports:

$$P_{hydro} = \Delta p \frac{\dot{m}}{\rho}.$$

The mechanical power is generated due to torque, τ , and angular velocity, ω :

$$P_{mech} = \tau \omega.$$

Flow Rate and Driving Torque

The mass flow rate generated at the pump is

$$\dot{m} = \dot{m}_{Ideal} - \dot{m}_{Leak},$$

where:

- \dot{m} is the actual mass flow rate.
- \dot{m}_{Ideal} is the ideal mass flow rate.
- \dot{m}_{Leak} is the internal leakage mass flow rate.

The driving torque required to power the pump is

$$\tau = \tau_{Ideal} + \tau_{Friction},$$

where:

- τ is the actual driving torque.
- τ_{Ideal} is the ideal driving torque.
- $\tau_{Friction}$ is the friction torque.

Ideal Flow Rate and Ideal Torque

The ideal mass flow rate is

$$\dot{m}_{\text{Ideal}} = \rho D_{\text{Sat}} \omega,$$

and the ideal generated torque is

$$\tau_{\text{Ideal}} = D_{\text{Sat}} \Delta p,$$

where:

- ρ is the average of the fluid densities at thermal liquid ports **A** and **B**.
- D_{Sat} is a smoothed displacement computed so as to remove numerical discontinuities between negative and positive displacements.
- ω is the shaft angular velocity.
- Δp is the pressure drop from inlet to outlet.

The saturation displacement is defined as:

$$D_{\text{Sat}} = \begin{cases} \sqrt{D^2 + D_{\text{Threshold}}^2}, & D \geq 0 \\ -\sqrt{D^2 + D_{\text{Threshold}}^2}, & D < 0 \end{cases}.$$

where:

- D is the displacement specified at physical signal port **D**.
- $D_{\text{Threshold}}$ is the specified value of the **Displacement threshold for motor-pump transition** block parameter.

Leakage and friction parameterization

You can parameterize leakage and friction analytically, using tabulated efficiencies or losses, or by input efficiencies or input losses.

Analytical

When you set **Leakage and Friction Parameterization** to **Analytical**, the leakage flow rate is

$$\dot{m}_{\text{Leak}} = \frac{K_{\text{HP}} \rho_{\text{Avg}} \Delta p}{\mu_{\text{Avg}}},$$

and the friction torque is

$$\tau_{\text{Friction}} = \left(\tau_0 + K_{\text{TP}} |\Delta p| \frac{|D_{\text{Sat}}|}{D_{\text{Nom}}} \tanh \left(\frac{4\omega}{(5e - 5)\omega_{\text{Nom}}} \right) \right),$$

where:

- K_{HP} is the Hagen-Poiseuille coefficient for laminar pipe flows. This coefficient is computed from the specified nominal parameters.
- μ is the dynamic viscosity of the thermal liquid, taken here as the average of its values at the thermal liquid ports.

- k is the friction torque vs. pressure gain coefficient at nominal displacement, which is determined from the **Mechanical efficiency at nominal conditions**, $\eta_{m,nom}$:

$$k = \frac{\tau_{fr,nom} - \tau_0}{\Delta p_{nom}}.$$

$\tau_{fr,nom}$ is the friction torque at nominal conditions:

$$\tau_{fr,nom} = \left(\frac{1 - \eta_{m,nom}}{\eta_{m,nom}} \right) D_{nom} \Delta p_{nom}.$$

- Δp_{Nom} is the specified value of the **Nominal pressure drop** block parameter. This is the pressure drop at which the nominal volumetric efficiency is specified.
- D_{Nom} is the specified value of the **Nominal Displacement** block parameter.
- τ_0 is the specified value of the **No-load torque** block parameter.
- ω_{Nom} is the specified value of the **Nominal shaft angular velocity** block parameter.

The Hagen-Poiseuille coefficient is determined from nominal fluid and component parameters through the equation

$$K_{HP} = \frac{D_{Nom} \omega_{Nom} \mu_{Nom} (1 - \eta_{v,Nom})}{\Delta p_{Nom}},$$

where:

- ω_{Nom} is the specified value of the **Nominal shaft angular velocity** parameter. This is the angular velocity at which the nominal volumetric efficiency is specified.
- μ_{Nom} is the specified value of the **Nominal Dynamic viscosity** block parameter. This is the dynamic viscosity at which the nominal volumetric efficiency is specified.
- $\eta_{v,Nom}$ is the specified value of the **Volumetric efficiency at nominal conditions** block parameter. This is the volumetric efficiency corresponding to the specified nominal conditions.

Tabulated Efficiencies

When you set **Leakage and friction parameterization** to Tabulated data - volumetric and mechanical efficiencies, the leakage flow rate is

$$\dot{m}_{Leak} = \dot{m}_{Leak,Pump} \frac{(1 + \alpha)}{2} + \dot{m}_{Leak,Motor} \frac{(1 - \alpha)}{2},$$

and the friction torque is

$$\tau_{Friction} = \tau_{Friction,Pump} \frac{1 + \alpha}{2} + \tau_{Friction,Motor} \frac{1 - \alpha}{2},$$

where:

- α is a numerical smoothing parameter for the motor-pump transition.
- $\dot{m}_{Leak,Motor}$ is the leakage flow rate in motor mode.
- $\dot{m}_{Leak,Pump}$ is the leakage flow rate in pump mode.
- $\tau_{Friction,Motor}$ is the friction torque in motor mode.
- $\tau_{Friction,Pump}$ is the friction torque in pump mode.

The smoothing parameter α is given by the hyperbolic tangent function

$$\alpha = \tanh\left(\frac{4\Delta p}{\Delta p_{\text{Threshold}}}\right) \cdot \tanh\left(\frac{4\omega}{\omega_{\text{Threshold}}}\right) \cdot \tanh\left(\frac{4D}{D_{\text{Threshold}}}\right),$$

where:

- $\Delta p_{\text{Threshold}}$ is the specified value of the **Pressure gain threshold for pump-motor transition** block parameter.
- $\omega_{\text{Threshold}}$ is the specified value of the **Angular velocity threshold for pump-motor transition** block parameter.
- $D_{\text{Threshold}}$ is the specified value of the **Angular velocity threshold for motor-pump transition** block parameter.

The leakage flow rate is calculated from the volumetric efficiency, a quantity that is specified in tabulated form over the Δp - ω - D domain via the **Volumetric efficiency table** block parameter. When operating in pump mode (quadrants **1** and **3** of the Δp - ω - D chart shown in the “Operation Modes” on page 1-672 figure), the leakage flow rate is:

$$\dot{m}_{\text{Leak,Pump}} = (1 - \eta_v)\dot{m}_{\text{Ideal}},$$

where η_v is the volumetric efficiency, obtained either by interpolation or extrapolation of the tabulated data. Similarly, when operating in motor mode (quadrants **2** and **4** of the Δp - ω - D chart), the leakage flow rate is:

$$\dot{m}_{\text{Leak,Motor}} = -(1 - \eta_v)\dot{m}.$$

The friction torque is similarly calculated from the mechanical efficiency, a quantity that is specified in tabulated form over the Δp - ω - D domain via the **Mechanical efficiency table** block parameter. When operating in pump mode (quadrants **1** and **3** of the Δp - ω - D chart):

$$\tau_{\text{Friction,Pump}} = (1 - \eta_m)\tau,$$

where η_m is the mechanical efficiency, obtained either by interpolation or extrapolation of the tabulated data. Similarly, when operating in motor mode (quadrants **2** and **4** of the Δp - ω - D chart):

$$\tau_{\text{Friction,Motor}} = -(1 - \eta_m)\tau_{\text{Ideal}}.$$

Tabulated Losses

When you set **Leakage and friction parameterization** to **Tabulated data - volumetric and mechanical losses**, the leakage (volumetric) flow rate is specified directly in tabulated form over the Δp - ω - D domain:

$$q_{\text{Leak}} = q_{\text{Leak}}(\Delta p, \omega, D_{\text{Sat}}).$$

The mass flow rate due to leakage is calculated from the volumetric flow rate:

$$\dot{m}_{\text{Leak}} = \rho q_{\text{Leak}}.$$

The friction torque is similarly specified in tabulated form:

$$\tau_{\text{Friction}} = \tau_{\text{Friction}}(\Delta p, \omega, D_{\text{Sat}}),$$

where $q_{\text{Leak}}(\Delta p, \omega)$ and $\tau_{\text{Friction}}(\Delta p, \omega)$ are the volumetric and mechanical losses, obtained through interpolation or extrapolation of the tabulated data specified via the **Volumetric loss table** and **Mechanical loss table** block parameters.

Input Efficiencies

When you set **Leakage and friction parameterization** to **Input signal - volumetric and mechanical efficiencies**, the leakage flow rate and friction torque calculations are identical to the **Tabulated data - volumetric and mechanical efficiencies** setting. The volumetric and mechanical efficiency lookup tables are replaced with physical signal inputs that you specify through ports **EV** and **EM**.

The efficiencies are positive quantities with value between 0 and 1. Input values outside of these bounds are set equal to the nearest bound (0 for inputs smaller than 0, 1 for inputs greater than 1). In other words, the efficiency signals are saturated at 0 and 1.

Input Losses

When you set **Leakage and friction parameterization** to **Input signal - volumetric and mechanical efficiencies**, the leakage flow rate and friction torque calculations are identical to the **Tabulated data - volumetric and mechanical efficiencies** setting. The volumetric and mechanical loss lookup tables are replaced with physical signal inputs that you specify through ports **LV** and **LM**.

The block ignores the sign of the input. The block sets the signs automatically from the operating conditions established during simulation—more precisely, from the Δp - ω quadrant in which the component happens to be operating.

Assumptions and Limitations

- Fluid compressibility is negligible.
- Loading on the motor shaft due to inertia, friction, and spring forces is negligible.

Variables

Use the **Variables** tab to set the priority and initial target values for the block variables prior to simulation. For more information, see “Set Priority and Initial Target for Block Variables”.

Ports

Input

D — Displacement volume, cm³/rev

physical signal

Physical signal input port for the volume of fluid displaced rotation. A smoothing function eases the transition between positive and negative input values.

EV — Volumetric efficiency, unitless

physical signal

Physical signal input port for the volumetric efficiency coefficient. The input signal has an upper bound at the **Maximum volumetric efficiency** parameter value and a lower bound at the **Minimum volumetric efficiency** parameter value.

Dependencies

To enable this port, set **Leakage and friction parameterization** to Input signal - volumetric and mechanical efficiencies.

EM — Mechanical efficiency, unitless

physical signal

Physical signal input port for the mechanical efficiency coefficient. The input signal has an upper bound at the **Maximum mechanical efficiency** parameter value and a lower bound at the **Minimum mechanical efficiency** parameter value.

Dependencies

To enable this port, set **Leakage and friction parameterization** to Input signal - volumetric and mechanical efficiencies.

LV — Volumetric loss, m³/s

physical signal

Physical signal input port for the volumetric loss, defined as the internal leakage flow rate between the pump inlets.

Dependencies

To enable this port, set **Leakage and friction parameterization** to Input signal - volumetric and mechanical losses.

LM — Mechanical loss, N*m

physical signal

Physical signal input port for the mechanical loss, defined as the friction torque on the rotating pump shaft.

Dependencies

To enable this port, set **Leakage and friction parameterization** to Input signal - volumetric and mechanical losses.

Conserving**A — Pump inlet**

thermal liquid

Thermal liquid conserving port associated with the pump inlet.

B — Pump outlet

thermal liquid

Thermal liquid conserving port associated with the pump outlet.

C — Pump Case

mechanical rotational

Mechanical rotational conserving port associated with the pump case.

R – Pump Shaft

mechanical rotational

Mechanical rotational conserving port associated with the rotational pump shaft.

Parameters**Leakage and friction parameterization – Parameterization of leakage flow rate and friction torque**

Analytical (default) | Tabulated data - volumetric and mechanical efficiencies | Tabulated data - volumetric and mechanical losses | Input signal - volumetric and mechanical efficiencies | Input signal - volumetric and mechanical losses

Method to compute flow-rate and torque losses due to internal leaks and friction. When you select **Analytical**, the block parameters are generally available from component data sheets. When you select **Tabulated data - volumetric and mechanical efficiencies** or **Tabulated data - volumetric and mechanical losses**, the block uses lookup tables to map pressure drop, angular velocity, and displacement to component efficiencies or losses.

When you select **Input signal - volumetric and mechanical efficiencies** or **Input signal - volumetric and mechanical losses**, the block performs the leakage flow rate and friction torque calculations the same as the **Tabulated data - volumetric and mechanical efficiencies** or **Tabulated data - volumetric and mechanical losses** settings, respectively, and the block enables the physical signal ports, **EV** and **EM**. You use these ports to specify the volumetric and mechanical efficiency.

Nominal displacement – Displacement at which to specify the volumetric efficiency

30 cm³/rev (default) | positive scalar

Fluid displacement for a given volumetric efficiency. These values are typically available at standard operating conditions in the manufacturer data sheet. The block uses this parameter to calculate the leakage flow rate and friction torque.

Nominal shaft angular velocity – Shaft angular velocity for given volumetric efficiency

188 rpm (default) | scalar

Angular velocity of the rotary shaft that corresponds to the given volumetric efficiency. These values are typically available at standard operating conditions in the manufacturer data sheet. The block uses this parameter to calculate the leakage flow rate and friction torque.

Dependencies

To enable this parameter, set **Leakage and friction parameterization** to **Analytical**.

Nominal pressure drop – Pressure drop for corresponding volumetric efficiency

10 MPa (default) | scalar

Pressure drop that corresponds to the given volumetric efficiency. These values are typically available at standard operating conditions in manufacturer data sheet. The block uses this parameter to calculate the internal leakage flow rate.

Dependencies

To enable this parameter, set **Leakage and friction parameterization** to **Analytical**.

Nominal dynamic viscosity — Dynamic viscosity at which to specify the volumetric efficiency

0.9 cP (default) | scalar

Dynamic viscosity of the hydraulic fluid for the given volumetric efficiency. These values are typically available at standard operating conditions in manufacturer data sheet. The block uses this parameter to calculate the internal leakage flow rate.

Dependencies

To enable this parameter, set **Leakage and friction parameterization** to Analytical.

Volumetric efficiency at nominal conditions — Volumetric efficiency at the specified nominal conditions

0.92 (default) | scalar in the range (0,1)

Volumetric efficiency for the given conditions. The block defines the volumetric efficiency as the ratio of actual to ideal volumetric flow rates. These values are typically available at standard operating conditions in manufacturer data sheet. The block uses this parameter to calculate the internal leakage flow rate.

Dependencies

To enable this parameter, set **Leakage and friction parameterization** to Analytical.

Mechanical efficiency at nominal conditions — Ratio of actual to ideal mechanical power

0.88 (default) | positive scalar

Ratio of actual mechanical power to ideal mechanical power at nominal conditions.

Dependencies

To enable this parameter, set **Leakage and friction parameterization** to Analytical.

No-load torque — Minimum torque required to induce shaft rotation

0 N*m (default) | scalar

Torque to overcome the seal friction and induce rotation of the mechanical shaft. This torque is the load-independent component of the total friction torque.

Dependencies

To enable this parameter, set **Leakage and friction parameterization** to Analytical.

Pressure drop vector for efficiencies, dp — Pressure drops for given volumetric and mechanical efficiencies

[.1, 1, 2] MPa (default) | vector

Pressure drops for the corresponding tabular efficiency data. The vector must be at least two elements in strictly increasing order.

You can specify the data for a single quadrant, (ω , Δp , D). Refer to the block description for the operation modes corresponding to the various quadrants.

Dependencies

To enable this parameter, set **Leakage and friction parameterization** to Tabulated data - volumetric and mechanical efficiencies.

Shaft angular velocity vector for efficiencies, w – Angular velocities at which to specify the volumetric and mechanical efficiencies

[25, 50, 100, 200, 300, 400] rad/s | vector

Shaft angular velocities for the corresponding tabular efficiency data. The vector must be at least two elements in strictly increasing order.

You can specify the data for a single quadrant, $(\omega, \Delta p, D)$. Refer to the block description for the operation modes corresponding to the various quadrants.

Dependencies

To enable this parameter, set **Leakage and friction parameterization** to Tabulated data - volumetric and mechanical efficiencies.

Displacement vector for efficiencies, D – Displacements at which to specify the volumetric and mechanical efficiencies

[-30, -19, 19, 30] cm³/rev (default)

Displacements at which to specify the efficiency tabular data. The vector must be at least two elements in strictly increasing order.

You can specify the data for a single quadrant, $(\omega, \Delta p, D)$. Refer to the block description for the operation modes corresponding to the various quadrants.

Dependencies

To enable this parameter, set **Leakage and friction parameterization** to Tabulated data - volumetric and mechanical efficiencies.

Volumetric efficiency table, $e_v(dp, w)$ – Volumetric efficiencies for given pressure drops, angular velocities, and displacements

repmat([.816, .908, .954, .977, .981, .984; .325, .663, .831, .916, .925, .946; .137, .568, .78, .892, .893, .91], 1, 1, 4) | matrix

Volumetric efficiencies at the specified fluid pressure drops, shaft angular velocities, and displacements. The efficiencies must be in the range of 0-1. M , N , and L are the sizes of the specified lookup-table vectors:

- M is the number of vector elements in the **Pressure drop vector for efficiencies, dp** parameter.
- N is the number of vector elements in the **Shaft angular velocity vector for efficiencies, w** parameter.
- L is the number of vector elements in the **Displacement vector for efficiencies, D** parameter.

You can specify the data for a single quadrant, $(\omega, \Delta p, D)$. Refer to the block description for the operation modes corresponding to the various quadrants.

Dependencies

To enable this parameter, set **Leakage and friction parameterization** to Tabulated data - volumetric and mechanical efficiencies.

Mechanical efficiency table, $e_m(dp,w)$ — Mechanical efficiencies for given pressure drops, angular velocities, and displacements

```
repmat([.996, .996, .996, .996, .996, .996; .988, .989, .989, .989, .989, .99
; .981, .981, .982, .982, .983, .984], 1, 1, 4) | matrix
```

Mechanical efficiencies corresponding to the specified fluid pressure drops, shaft angular velocities, and displacements. The efficiencies must be in the range of 0–1. M , N , and L are the sizes of the specified lookup-table vectors:

- M is the number of vector elements in the **Pressure drop vector for efficiencies, dp** parameter.
- N is the number of vector elements in the **Shaft angular velocity vector for efficiencies, w** parameter.
- L is the number of vector elements in the **Displacement vector for efficiencies, D** parameter.

You can specify the data for a single quadrant, $(\omega, \Delta p, D)$. Refer to the block description for the operation modes corresponding to the various quadrants.

Dependencies

To enable this parameter, set **Leakage and friction parameterization** to Tabulated data - volumetric and mechanical efficiencies.

Pressure drop vector for losses, dp — Pressure drop for corresponding losses

```
[.1, 1, 2] MPa (default)
```

Pressure drops for the corresponding tabular loss data. The vector must be at least two elements in strictly increasing order.

You can specify the data for a single quadrant, $(\omega, \Delta p, D)$. Refer to the block description for the operation modes corresponding to the various quadrants.

Dependencies

To enable this parameter, set **Leakage and friction parameterization** to Tabulated data - volumetric and mechanical losses.

Shaft angular velocity vector for losses, w — Shaft speed for corresponding losses

```
[25, 50, 100, 200, 300, 400] rad/s (default)
```

Shaft angular velocity for the corresponding tabular loss data. The vector must be at least two elements in strictly increasing order.

You can specify the data for a single quadrant, $(\omega, \Delta p, D)$. Refer to the block description for the operation modes corresponding to the various quadrants.

Dependencies

To enable this parameter, set **Leakage and friction parameterization** to Tabulated data - volumetric and mechanical losses.

Displacement vector for losses, D — Displacements at which to specify the volumetric and mechanical losses

```
[-30, -19, 19, 30] cm3/rev (default)
```

Displacements at which to specify the loss tabular data. The vector must be at least two elements in strictly increasing order.

You can specify the data for a single quadrant, $(\omega, \Delta p, D)$. Refer to the block description for the operation modes corresponding to the various quadrants.

Dependencies

To enable this parameter, set **Leakage and friction parameterization** to Tabulated data - volumetric and mechanical losses.

Volumetric loss table, $q_loss(dp,w)$ – Internal leakage flow rates for corresponding pressure drops, angular velocities, and displacements

```
repmat([.0282, .0253, .0241, .0235, .0291, .0325; .2596, .1271, .1017, .0917, .1216, .1142; .7874, .1901, .141, .1211, .1797, .1978] * 1e-3, 1, 1, 4) m^3/s
```

Volumetric losses at the specified fluid pressure drops, shaft angular velocities, and displacements. The block defines volumetric loss the internal leakage volumetric flow rate between port **A** and port **B**. M and N are the sizes of the specified lookup-table vectors:

- M is the number of vector elements in the **Pressure drop vector for losses, dp** parameter.
- N is the number of vector elements in the **Shaft angular velocity vector for losses, w** parameter.

You can specify the data for a single quadrant, $(\omega, \Delta p, D)$. Refer to the block description for the operation modes corresponding to the various quadrants.

Dependencies

To enable this parameter, set **Leakage and friction parameterization** to Tabulated data - volumetric and mechanical losses.

Mechanical loss table, $torque_loss(dp,w)$ – Friction torques for the corresponding pressure drops, angular velocities, and displacements

```
repmat([.002, .002, .002, .002, .002, .002; .06, .055, .055, .055, .055, .05; .19, .19, .18, .18, .17, .16], 1, 1, 4) N*m
```

Mechanical losses for the given pressure drops, shaft angular velocities, and displacements. The block defines mechanical loss as the friction torque due to seals and internal components. M and N are the sizes of the specified lookup-table vectors:

- M is the number of vector elements in the **Pressure drop vector for losses, dp** parameter.
- N is the number of vector elements in the **Shaft angular velocity vector for losses, w** parameter.

You can specify the data for a single quadrant, $(\omega, \Delta p)$. Refer to the block description for the operation modes corresponding to the various quadrants. The tabulated data for the mechanical losses must obey the convention in the figure, with positive values at positive angular velocities and negative values at negative angular velocities.

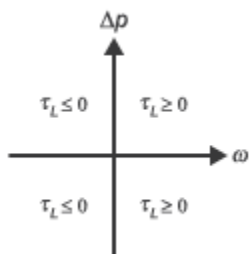

Dependencies

To enable this parameter, set **Leakage and friction parameterization** to Tabulated data - volumetric and mechanical losses.

Minimum volumetric efficiency – Lower saturation bound on the volumetric efficiency input signal

1e-3 (default) | scalar in the range (0,1)

Smallest allowed value of the volumetric efficiency. The input from the physical signal port **EV** saturates inputs below this value.

Dependencies

To enable this parameter, set **Leakage and friction parameterization** to Input signal - volumetric and mechanical efficiencies.

Maximum volumetric efficiency – Upper saturation bound on the volumetric efficiency input signal

1 (default) | scalar in the range (0,1)

Largest allowed value of the volumetric efficiency. The input from the physical signal port **EV** saturates inputs above this value.

Dependencies

To enable this parameter, set **Leakage and friction parameterization** to Input signal - volumetric and mechanical efficiencies.

Minimum mechanical efficiency – Lower saturation bound on the volumetric efficiency input signal

1e-3 (default) | scalar in the range (0,1)

Smallest allowed value of the mechanical efficiency. The input from the physical signal port **EM** saturates inputs below this value.

Dependencies

To enable this parameter, set **Leakage and friction parameterization** to Input signal - volumetric and mechanical efficiencies.

Maximum mechanical efficiency – Upper saturation bound on the volumetric efficiency input signal

1 (default) | scalar in the range (0,1)

Largest allowed value of the mechanical efficiency. The input from the physical signal port **EM** saturates inputs above this value.

Dependencies

To enable this parameter, set **Leakage and friction parameterization** to Input signal - volumetric and mechanical efficiencies.

Pressure drop threshold for motor-pump transition – Pressure drop at which to initiate a smooth transition between motor and pump modes

1e-3 MPa (default) | scalar

Pressure drop from inlet to outlet below which the block begins to transition between motoring and pumping modes. The block uses a hyperbolic tangent function to smooth the leakage flow rate and friction torque.

Dependencies

To enable this parameter, set **Leakage and friction parameterization** to Input signal - volumetric and mechanical efficiencies or Input signal - volumetric and mechanical losses.

Angular velocity threshold for motor-pump transition – Angular velocity at which to initiate a smooth transition between pump and motor modes

10 rad/s (default) | scalar

Shaft angular velocity below which the block begins to transition between motoring and pumping modes. The block uses the hyperbolic tangent function to smooth the leakage flow rate and friction torque.

Dependencies

To enable this parameter, set **Leakage and friction parameterization** to Input signal - volumetric and mechanical efficiencies or Input signal - volumetric and mechanical losses.

Cross-sectional area at ports A and B – Flow area at the component inlet and outlet

0.01 m² (default) | positive scalar

Flow area at the component inlet and outlet. The areas are assumed equal.

Check if operating beyond the octants of supplied tabulated data – Simulation warning mode for operating conditions outside the range of tabulated data

None (default) | Warning

Simulation warning mode for operating conditions outside the range of tabulated data. Select **Warning** to be notified when the fluid pressure drop, shaft angular velocity, or instantaneous displacement cross outside the specified tabular data. The warning does not cause simulation to stop.

Dependencies

To enable this parameter, set **Leakage and friction parameterization** to:

- Tabulated data - volumetric and mechanical efficiencies
- Tabulated data - volumetric and mechanical losses
- Input signal - volumetric and mechanical efficiencies
- Input signal - volumetric and mechanical losses

Check if operating outside of motor mode – Simulation warning mode for operating conditions outside motoring mode

None (default) | Warning

Simulation warning mode for operating conditions outside the motoring mode. The block generates a warning if the motor transitions to pumping mode. Select **Warning** to be notified when this transition occurs. The warning does not cause simulation to stop.

Extended Capabilities

C/C++ Code Generation

Generate C and C++ code using Simulink® Coder™.

See Also

[Centrifugal Pump \(TL\)](#) | [Fixed-Displacement Motor \(TL\)](#) | [Variable-Displacement Pump \(TL\)](#)

Introduced in R2017b

Bibliography

- [1] Cornell, C.R. "Dynamic Simulation of a Hydrostatically Propelled Vehicle." SAE paper 811253, 1981, p. 22.
- [2] "Flow of Fluids Through Valves, Fittings, and Pipe." Crane Valves North America. Technical Paper No. 410.
- [3] Hicks, T. G. and T. W. Edwards. *Pump Application Engineering*, New York: McGraw-Hill, 1971.
- [4] Idelchik, I. E. *Handbook of Hydraulic Resistance*. New York: CRC Begell House, 1994.
- [5] Karassic, I. J., J. P. Messina, P. Cooper, and C. C. Heald. *Pump Handbook*. Fourth edition. New York: McGraw-Hill, 2008.
- [6] Keller, George R. *Hydraulic System Analysis*. Seattle, WA: Hydraulics & Pneumatics Magazine, 1970.
- [7] Manring, Noah D. *Hydraulic Control Systems*. Hoboken, NJ: John Wiley & Sons, 2005.
- [8] White, F. M. *Viscous Fluid Flow*. New York: McGraw-Hill, 1991.
- [9] Yeapple, F. *Fluid Power Design Handbook*, New York: Marcel Dekker, 1995.

